

Genius™ Irrigation System Training Manual

IrriGreen, Inc.

2015

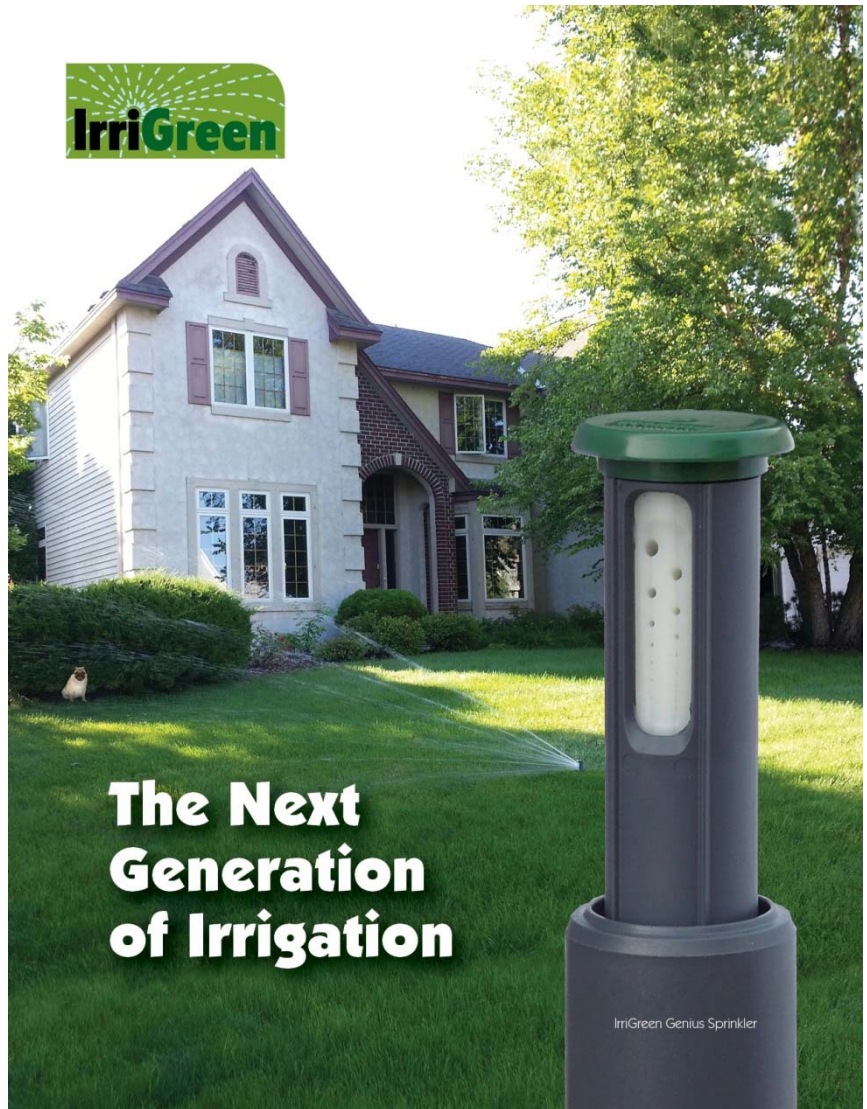

IrriGreen® manufactures and sells landscape irrigation systems that save water and simplify installation. We use digital technology to water the exact landscape shape cutting installation time in half and reducing wasted water by 50%. IrriGreen contractors generate more profit per installation and greater ownership value to end users.



IrriGreen, Inc.
5250 W. 73rd St., Suite I, Edina, MN 55439
Phone: 612-238-7575
www.irrigreen.com



TABLE OF CONTENTS

Introduction	2
Comparison of the Genius Irrigation System to Conventional Systems	3
Key Features and Benefits of the Genius Irrigation System	4
Selling the Genius Irrigation System	5
Designing & Estimating the Genius Irrigation System	6
Installing the Genius Irrigation System	8
Programming the Genius Irrigation System	12
Replacing the Genius Nozzle and Filter System	19
Warranty	20

Per FCC 15.19 (a) (3) and (a) (4): This device complies with part 15 of the FCC Rules. Operation is subject to the following two conditions: (1) This device may not cause harmful interference, and (2) this device must accept any interference received, including interference that may cause undesired operation.

Per FCC 15.21: The user and installer of the IrriGreen Genius Irrigation System shall not make any modifications to the system not expressly approved by IrriGreen. Unauthorized modifications will void the warranty and void the user's authority to operate the equipment per FCC rules.



IrriGreen® Genius™ Irrigation System Training Manual

Introduction

The Genius irrigation system combines digital technology with a patent pending nozzle design to produce an irrigation system capable of distributing water in patterns that fit the shape of the landscape. The Genius irrigation system does this while both reducing the water required to irrigate the landscape **and** saving significant installation time and materials.

The Genius irrigation system is designed to significantly reduce the labor required to install in-ground irrigation systems while at the same time reducing water required to sufficiently water the lawn. The center of the system is the Genius sprinkler that can be programmed to water a wide variety of shapes and sizes. This sprinkler reduces the need for distribution pipe by up to 85%, significantly cuts the number of sprinkler heads required and reduces the amount of water typically wasted to irrigate the lawn by up to 50%. While the cost of the water is born by the property owner, it is still a barrier that can be turned into an opportunity when selling the benefits of Genius irrigation systems to consumers.

Reducing installation labor for contractors and reducing end user water bills are compelling reasons for irrigation contractors to sell the Genius irrigation system. You will be able to address business in more price sensitive areas by offering services at a reduced price while maintaining profitability on every installation. Your customers will be happier with green, hassle free lawns and lower water bills than those customers with conventional irrigation systems.

This training manual is a component of a training program developed to train experienced irrigation contractors on the techniques unique to installing the Genius irrigation system. This program is intended for licensed (if required by local and/or state code), experienced irrigation contractors for residential and commercial in-ground irrigation systems. It is not intended as a complete or comprehensive training program for installing in-ground irrigation systems.

THIS TRAINING PROGRAM IS INTENDED FOR IRRIGATION CONTRACTORS THAT ARE ALREADY LICENSED AND/OR EXPERIENCED IRRIGATION PROFESSIONALS. (NOTE: PROFESSIONAL IRRIGATION TRAINING RECOMMENDED.)

The following points will be covered by this training program and manual:

- Comparison of the Genius irrigation system to conventional sprinkler systems.
- Key features and benefits of the Genius irrigation system.
- Selling the Genius irrigation system.
- Installation techniques unique to the Genius irrigation system.
- Programming the Genius sprinklers.
- System warranty information.



Comparison of the Genius Irrigation System to Conventional Systems

1. System similarities, the Genius irrigation system:

- Designed to be permanently installed into the landscapes of residential and commercial properties.
- Designed for use with conventional irrigation controllers, rain sensors, etc. – a hybrid system.
- Requires the same 24 VAC low voltage power source for Genius Server as conventional controllers.
- Uses similar distribution pipe and fittings currently being used to install conventional in-ground irrigation systems, but significantly less pipe length and fewer fittings.
- Requires the same maintenance for spring start-up and fall blow-outs as conventional irrigation systems, and is compatible with regular sequencing for typical blow-out procedures.
- Irrigates in watering zones – 1 sprinkler for 1 zone.
- Works in conjunction with standard industry controllers/schedulers.
- Uses the same water source as conventional systems.

2. System differences, the Genius irrigation system:

- Connects off the main line, no need for laterals and valve boxes.
- Uses software in sprinklers, servers and programmers so the water pattern for each individual Genius sprinkler can be programmed to fit the exact landscape it is watering.
- Eliminates the need for head-to-head watering overlap (see graphics below, Conventional vs. IrriGreen).
- Genius Sprinklers digitally control the water distance and rotational speed of the multi-stream nozzle.
- Uses 12 VDC to power and communicate with each Genius Sprinkler, so distances up to 700 feet away from the Genius Server.
- Requires the watering pattern for each Genius sprinkler be programmed (using IrriGreen's Genius Programmer) to fit the individual landscape shape being watered in each zone.
- Includes an IrriGreen Genius Server which is electrically connected to a 3rd party irrigation clock and to each sprinkler plus a wireless Genius Programmer for mapping each watering zone.
- The Genius Programmer can be used for mapping each watering zone up to 200 feet away from the Genius Server.
- We recommend a master shutoff valve be installed between the water source and the Genius sprinklers.

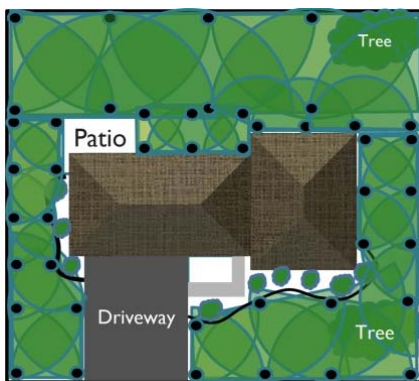

Conventional System

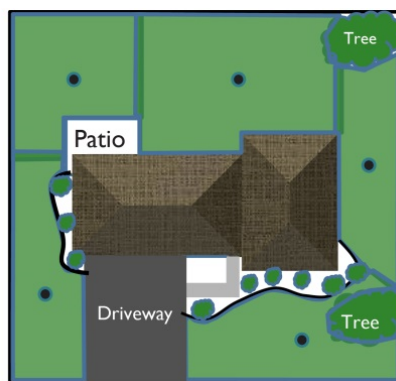

IrriGreen System



IrriGreen Nozzle



Key Features and Benefits of the Genius Irrigation System

Because the Genius sprinklers are individually programmable, each sprinkler can be programmed to water the specific landscape shape within the watering zone it is located. During the installation process, the water throw distances are programmed for each individual sprinkler to match the landscape shape it will irrigate. Minimum watering overlap is recommended between Genius sprinklers, and the need for head-to-head sprinkler watering coverage is eliminated. This elimination of required head-to-head coverage can result in saving as much as 50% of the wasted water.

Since each sprinkler has its own self-contained flow control valve, the need for valve boxes servicing multi-head zones is no longer necessary. This in turn reduces the amount of distribution pipe required to install a system, in many cases by 85%, which also reduces the time required to pull or trench the pipe. The result is a significant savings in installation labor, reducing the time required to install a given system by 50% or more.

Key Feature: Digitally controlled water distribution at individual sprinkler heads

- Reduces the labor required to install the entire system.
- Capability to program the watering pattern to fit the shape of the landscape.
- Minimizes over watering by eliminating the need for head-to-head coverage.
- Ensures accuracy of water delivery precipitation rate.
- Provides accurate watering times and precipitation rates during installation.
- Reduces the amount of distribution pipe required for installation.
- Reduces the number of irrigation sprinklers required for installation – 1 sprinkler for 1 zone.
- Reduces the water typically wasted due to overlap while irrigating turf areas by up to 50%.

Key Feature: Unique streaming nozzle design (patents pending)

- Irrigates watering zone using streams of water, reducing wind drift and increasing soil moisture.
- Increased droplet size from streams rather than spray or mist, which drives water into soil.
- Creates a more even distribution uniformity over entire watering zone.
- Reduces the potential for dry spots and minimizes over spraying onto hardscape areas.
- Uses less water and waters more accurately.

Key Feature: Standard industry design components

- Works with typical irrigation water sources with standard pipe/tube fittings and electrical connectors.
- Works in conjunction with standard industry controllers/schedulers.
- Compatible with rain and/or moisture sensors and other water saving technologies.
- Capable of functioning in a hybrid system with conventional watering zones using spray, rotor or drip.



Selling the Genius Irrigation System

Your customers will likely be attracted to the Genius irrigation system because of the financial aspect of the water savings while others may want it because it is “green”.

1. Target Customers

- Residential homeowners
- Commercial property owners
- Real estate management firms, consultants and homeowner associations
- “Green” and Cleantech customers
- Customers concerned about the cost of water
- Early “technology” adopters

2. Why will residential and commercial end users want to buy a Genius irrigation system?

- Cost savings from lower water bills (vs. conventional systems)
- Water savings (being green)
- Less mess and hassle due to torn up landscape
- Reduced installation time
- 21st Century technology

3. Environmentally conscious customers and early adopters will also want to buy a Genius irrigation system.

- They want a green lawn
- They want to be “green”
- They want to save money
- They want to be sustainable
- They like to try new things



Designing & Estimating the Genius Irrigation System

Use the following steps to plan your design:

1. Measure water supply pressure and capacity in GPM at the proposed site.

- Use a water pressure gauge and record the pressure in PSIG at an outdoor spigot.
- Most city water systems supply between 10-12 GPM at each spigot – please check if uncertain.
- A 1" pipe diameter (or larger) is recommended for distribution of the main water supply line for the Genius irrigation system. A ¾" main line pipe may provide enough GPM at pressures above 60 PSI, but will experience more pressure drop and shorter throw distances. A ½" pipe or smaller is not recommended for main lines. A short run of funny pipe or swing pipe is used from the main line to individual sprinkler heads.
- The chart below can be used to plan the Genius sprinkler head spacing, and illustrates the maximum design water throw distance from a sprinkler head based on water supply pressure. (NOTE: it is important that calculations for additional pressure drop due to elevation changes, length of main line and use of anti-syphon valves be subtracted from the water supply pressure to each sprinkler head.)

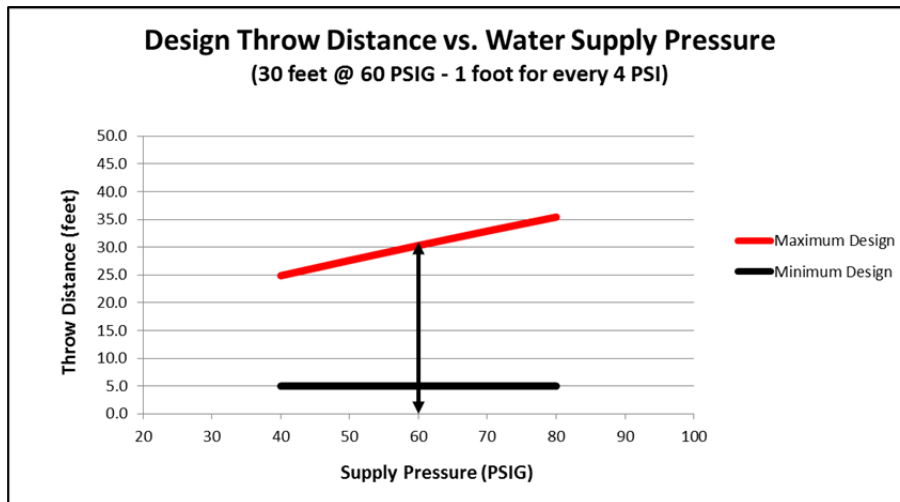

2. Locating the Genius sprinkler heads for each watering zone

The maximum distance that a Genius sprinkler will uniformly throw water depends on water supply pressure and pressure drop to the sprinkler head. Since Genius sprinklers will often be placed near the center of an area of landscape, the diagonal distance to the corners will determine the maximum distance. For instance, in a 42 x 42 foot square or a 24 x 55 foot rectangle, the diagonal distance to the corners is 30 feet. The minimum design distance that a Genius sprinkler will uniformly throw water is 5 feet. See examples of maximum throw distance (in blue) and minimum throw distance (in red) below.



3. Consider other site specific issues and regulations

- Local, state and HOA regulations
 - Rain sensor requirements (Note: may be required in some states)
 - Soil type may determine how deep to bury the pipe and whether to pull poly pipe or trench in PVC pipe
 - Presence of landscape obstacles like trees, fences, and elevation changes may inhibit watering patterns
-



Installing the Genius Irrigation System

Use the following installation steps:

1. Install plumbing as required by installation and regulations.
2. Install back-flow preventer (anti-syphon valve).
3. Install a master shut off valve (necessary for power outages).
4. Mark sprinkler placement per design plan.
5. Install main line pipe along with multi-wire cable to marked locations.

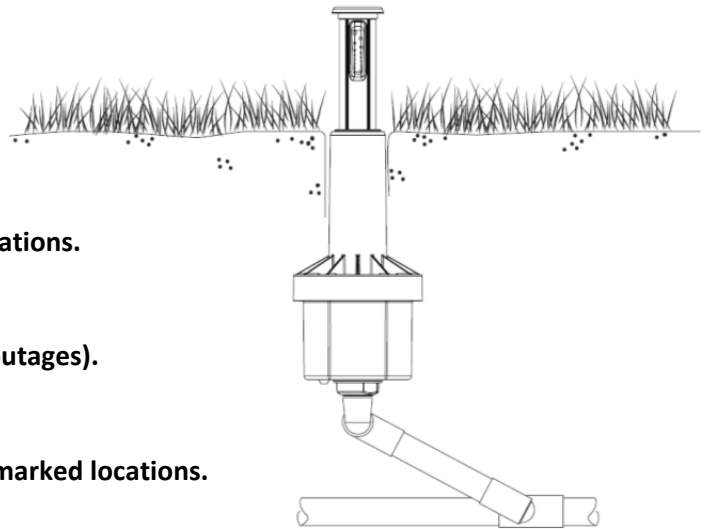

6. Installing each Genius sprinkler:

- Before connecting sprinklers – flush out the system laying flexible pipe outside each sprinkler hole.
- Connect the sprinkler fitting (¾ inch FPT) to the main water line using funny pipe or swing pipe.
- Install the flexible pipe to the main line and connect the sprinkler with a ¾ inch fitting and Teflon tape.
- Position sprinkler so the top cap is about ½ inch above the ground (dirt portion of the sod layer – see photo).



- Connect the white sprinkler wire to the white common wire in the multi-wire cable using waterproof connectors. Continue the white wire connection (common) to all other sprinklers.
- Connect the red sprinkler wire to another colored wire in the multi-wire cable using waterproof connectors. Record the color wire connected to each sprinkler for each numbered watering zone.

7. Installing the Genius server:

- Feed the multi-wire cable coming in from the field through the grommet on the bottom left of the server closest to the terminal strip located on the left. (See photos and notes on following 2 pages.)
- Connect the white wire of the multi-wire cable to the COMMON terminal (top) of the left terminal strip.
- Connect the remaining colored wires to individual OUT terminals numbered 1 – 8 matching the coloring of individual sprinklers from each watering zone connected in step 6 above.



Wiring coming into the IrriGreen Genius server from the field:

- IrriGreen Genius sprinkler
- ¾" MPT to swing pipe fitting
- Connector from main line to funny pipe
- Run of funny pipe to 1" main poly
- 2-pair conductor wire pigtail (on sprinkler)
- Waterproof connectors to hook up sprinkler
- Multi-conductor wire to IrriGreen server

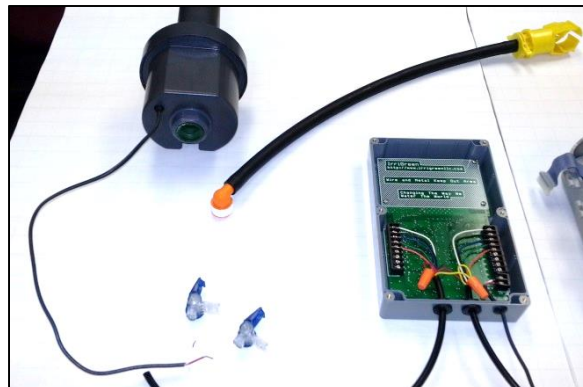

Wiring going out from IrriGreen Genius server to a 3rd party controller/scheduler:

- Left side IrriGreen server – OUT to field 12 VDC
- Right side IrriGreen server – IN from clock 24 VAC
- Bottom right IrriGreen server – 24 VAC power
- Left side 3rd party controller
 - Top left – rain (or moisture) sensor leads
 - Next lead – remote control lead
 - Next 3 leads – 24 VAC power
- Right side 3rd party controller
 - Bottom lead – common
 - Next lead up – ACV shut-off valve (or pump)
 - Next 8 leads – Zones 1 through 8

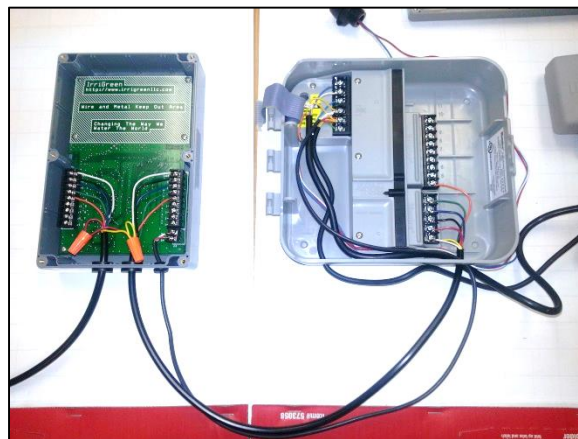

Wiring additional items to 3rd party controller/scheduler:

- Connect the 24 VAC transformer for power
- Run 2-pair conductor to IrriGreen for 24 VAC power
- Connect the rain (or moisture) sensor to the controller
 - Install sensor as indicated by manufacturer
 - Install wireless receiver inside building
 - Connect leads to controller
- Connect the remote control to the controller
 - Install remote key (plug) outside
 - Run wire leads through wall
 - Connect leads to controller

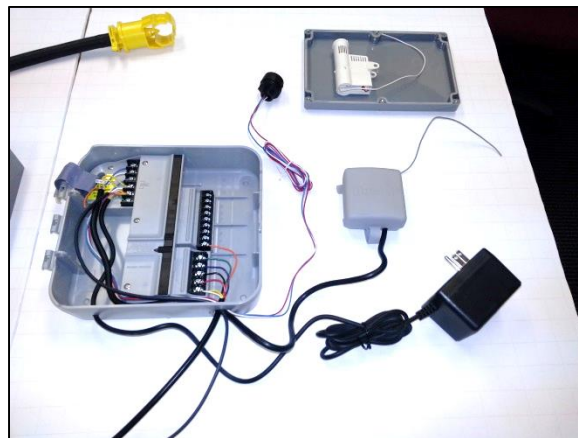



Wiring diagram for Irrigreen Genius Server:

(in this example)

7 leads OUT to field (12 VDC)

- Common (white) →
- Zone 1 (black) →
- Zone 2 (blue) →
- Zone 3 (green) →
- Zone 4 (orange) →
- Zone 5 – Zone 8 (open, no wires)

- ACV shut-off (red wires) →
- 24 VAC com (yellow wires) →



(in this example)

7 Leads IN from clock (24 VAC)

- ← Common (white)
- ← Zone 1 (black)
- ← Zone 2 (blue)
- ← Zone 3 (green)
- ← Zone 4 (orange)
- ← Zone 5 – Zone 8 (no wires)
- ← 24 VAC power (white)
- ← 24 VAC power (red)
- ← ACV shut-off (red wires)
- ← 24 VAC com (yellow wires)

***Note: Do not connect 12 VDC to 24 VAC common**

Wiring diagram for 3rd party controller/scheduler:

Multi-leads in to controller

- Rain Sensor 1 (blue) →
- Rain Sensor 2 (white) →
- Remote control (blue) →
- 24 VAC power (white) →
- 24 VAC power (red) →
- 24 VAC Com (yellow) →



7 Leads in from Genius server

- ← Zone 5 – Zone 8 (no wires)
- ← Zone 4 (orange)
- ← Zone 3 (green)
- ← Zone 2 (blue)
- ← Zone 1 (black)
- ← ACV shut-off (red)
- ← Common (white/yellow)

***NOTE: Run 24 VAC power from 3rd party controller to Irrigreen Server using 2-conductor irrigation wire.**



8. Before covering the Genius sprinklers, test each sprinkler using the Genius Mobile App:

- [Please refer to Step 2 on page 14 to set the programmer to the address on the server.]
- [Please refer to Step 3 on page 15 – the first 5 bullet points – for best practices to check for good electrical connections between the sprinkler and server.]
- You should test all sprinklers in this manner to be certain all electrical connections are working.

9. Before burying the Genius sprinklers, test for leaks at all fittings by turning on the water. (NOTE: If you are using an ACV for emergency shut-off, then you will need to open this valve for proper water supply.)

10. Connect accessory devices like rain and moisture sensors to unused valve inputs on each server or to a conventional 3rd party controller.

11. Connect an Irrigreen flow meter to the Genius Controller and wire 24VAC to the controller AC terminals.

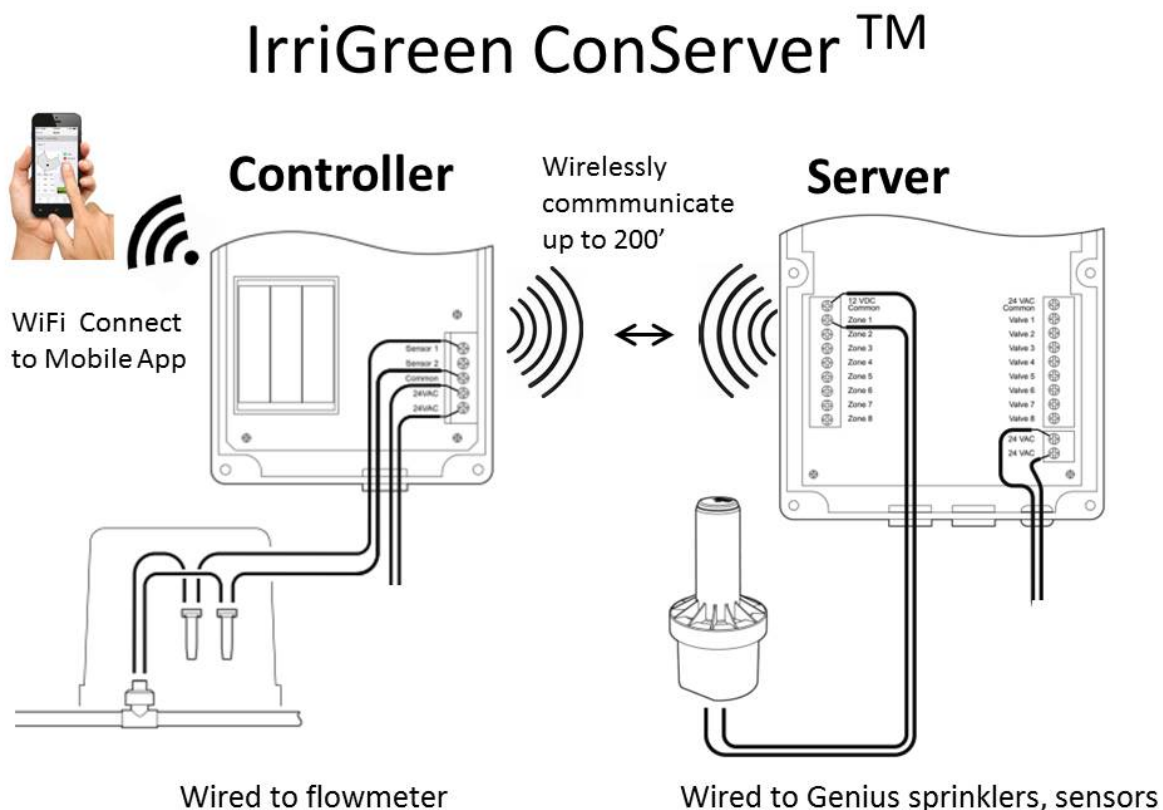



Programming the Genius Irrigation System

1. Overview Mobile App Screens

<u>Screen</u>	<u>Description of Screen Function</u>
Customer	Enter and manage multiple physical addresses and Genius Irrigation Systems
Dashboard	Display Genius system status, water use, run time and sprinkler health
Server	Enter Genius Server addresses, select zones and select flow meters
Zones	View, program and change individual sprinkler watering zones
Schedule	View, program and change watering schedule, plus sensor inputs
Manual	Turn an individual sprinkler on or off
Settings	Change passwords and Wi-Fi settings

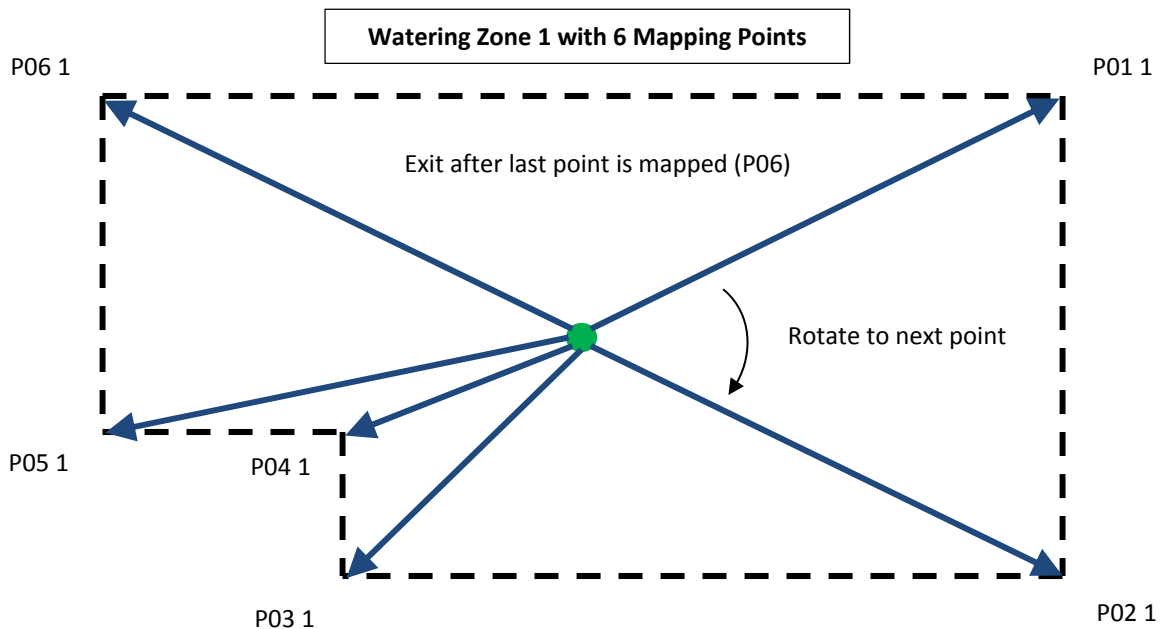

2. Customer Screen

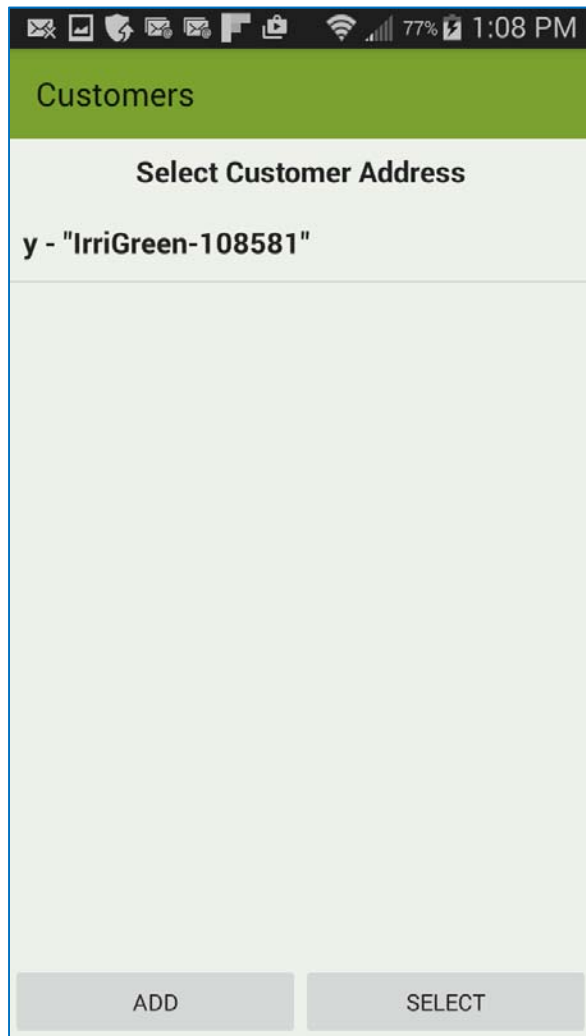

Select a Genius Controller to operate

- Enter the name and address of the installation
- Select the IrriGreen Wi-Fi Network
- Enter the SSID password "Genius0103" (See yellow arrow)



3. Dashboard Screen

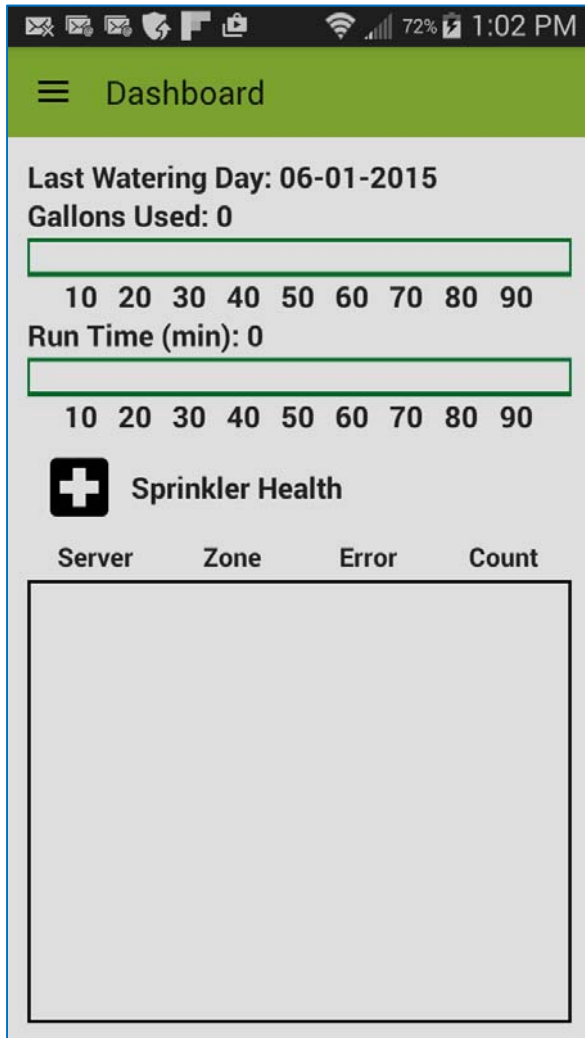

View the last watering day, number of gallons used and total run time for all servers

View and clear individual sprinkler errors such as valve, rotor and wiring errors

4. Server Screen

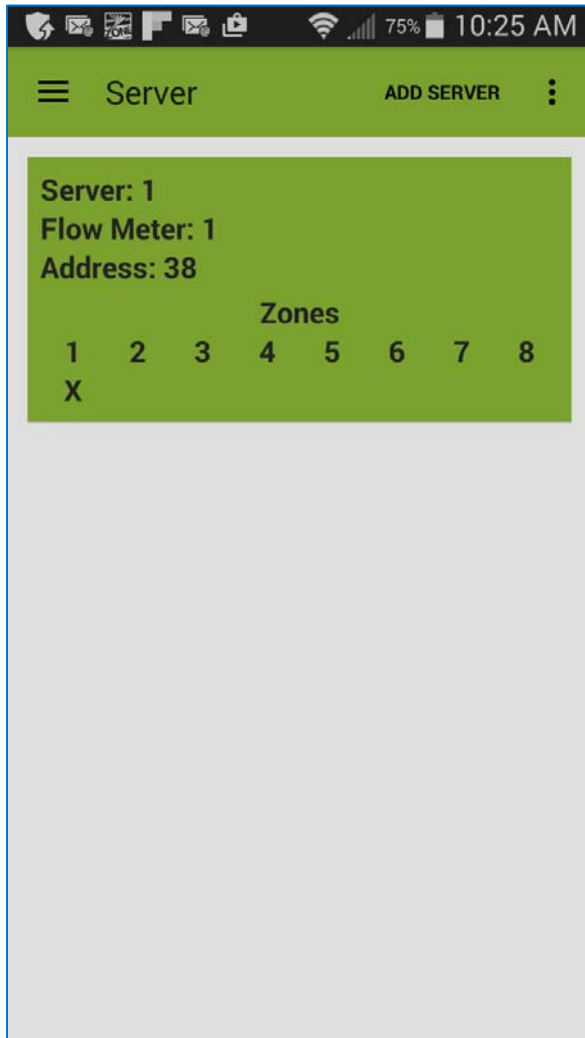

Select a Genius Server to modify

- Select a flow meter based for calibration and monitoring the sprinkler
- Select the active zones on the Server with an "X" (deselect inactive zones with blank)
- Select the Server Address (see yellow arrow)



5. Schedule Screen

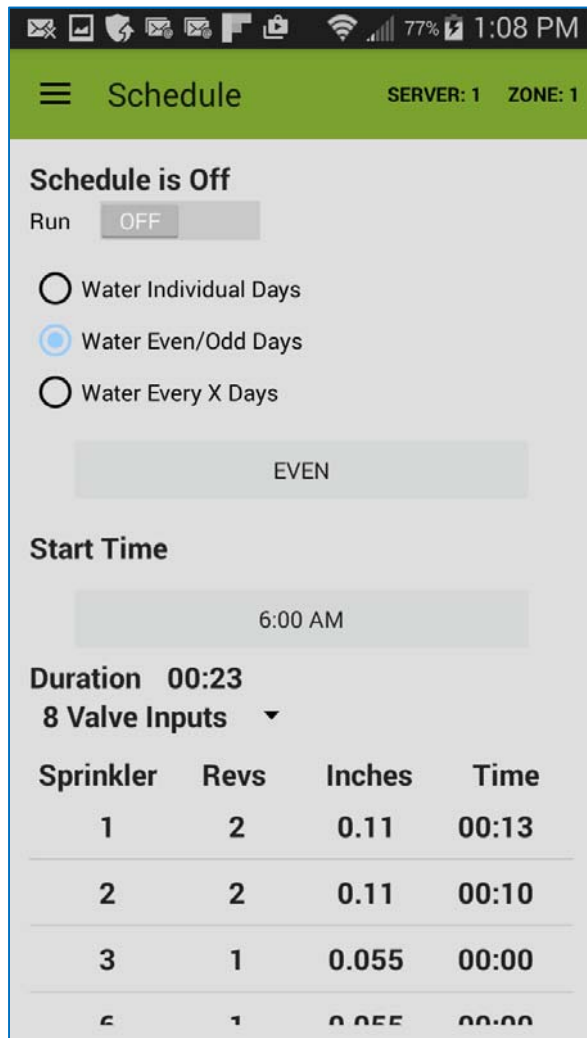

Select a Genius Server to schedule

- Enable or disable the schedule
- Water days of the week by selecting days Sunday – Saturday
- Water odd or even days of the week
- Select an interval to water starting i.e. 2 for 2,4,6 or 3 for 3,6,12
- Select a start time for the schedule
- Display the duration for all zones combined – they will water in sequential order
- Select whether the Server Valve Inputs are Valve Inputs or Sensor Inputs (Rain, Moisture)
- Set the number of revolutions for each zone’s sprinkler

(Note: the time can be used to set the run time when a conventional clock is used.)

6. Zone Screen

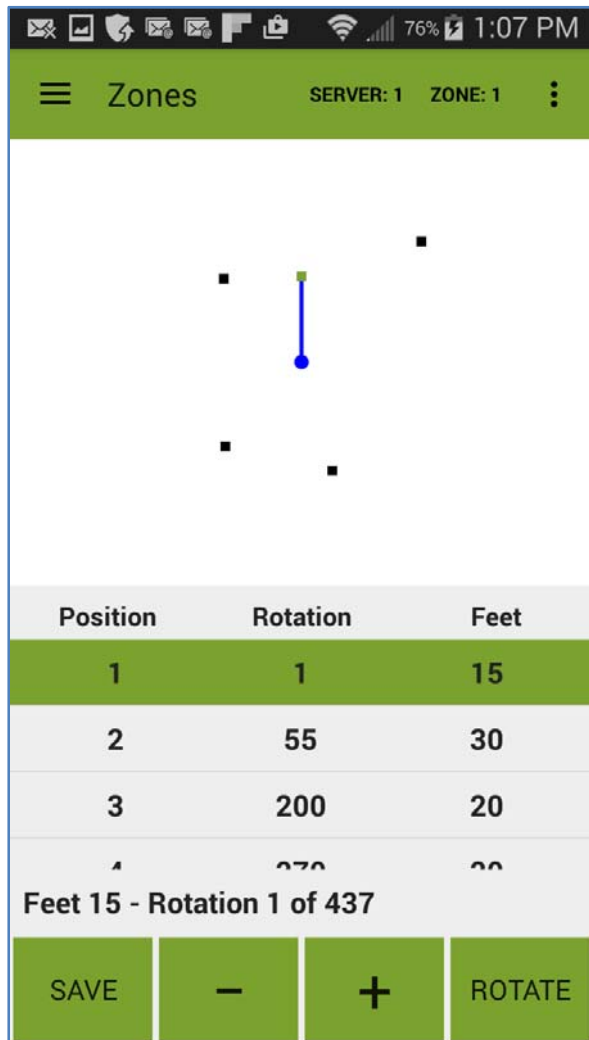

Select a Server and Zone to Program

- SAVE a position (Rotation, Feet) or INSERT a new position
- **Use** - /+ to change the distance of the streams in feet (hold to accelerate)
- ROTATE the streams clockwise (hold to accelerate)
- Top right drop down box
 - Recall: read Zone data stored in sprinkler back to Zone data in Server
 - Erase: erase all of the Zone positions and start over
 - Calibrate: automatically determines effective pressure and calibrates sprinkler
 - Exit: end Zone programming



7. Manual Screen

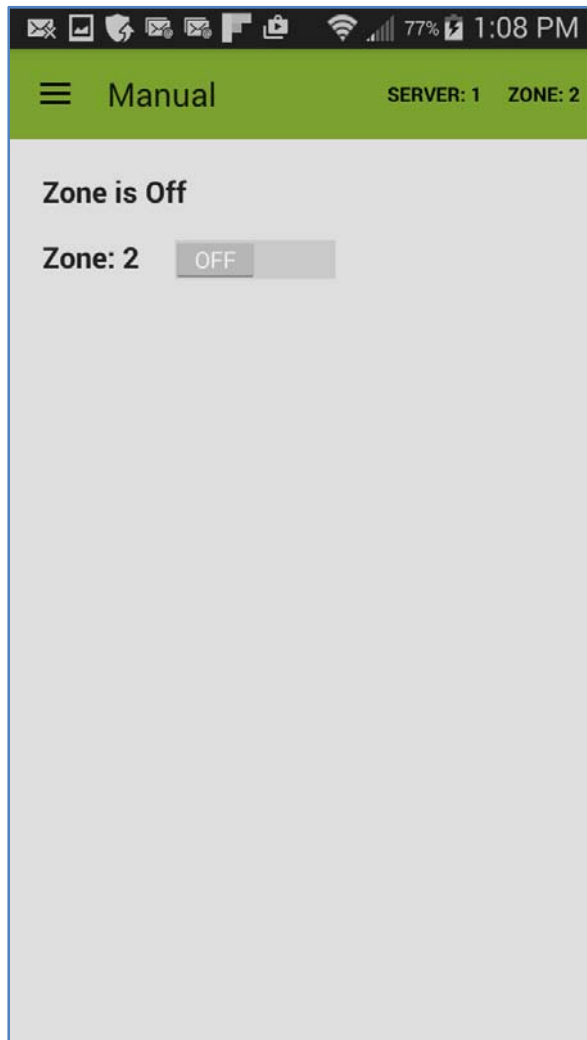

Select a Server and Zone

- Turn the Zone on (run) or off

8. Setting Screen

Set the system password



Replacing the Genius Nozzle and Filter System

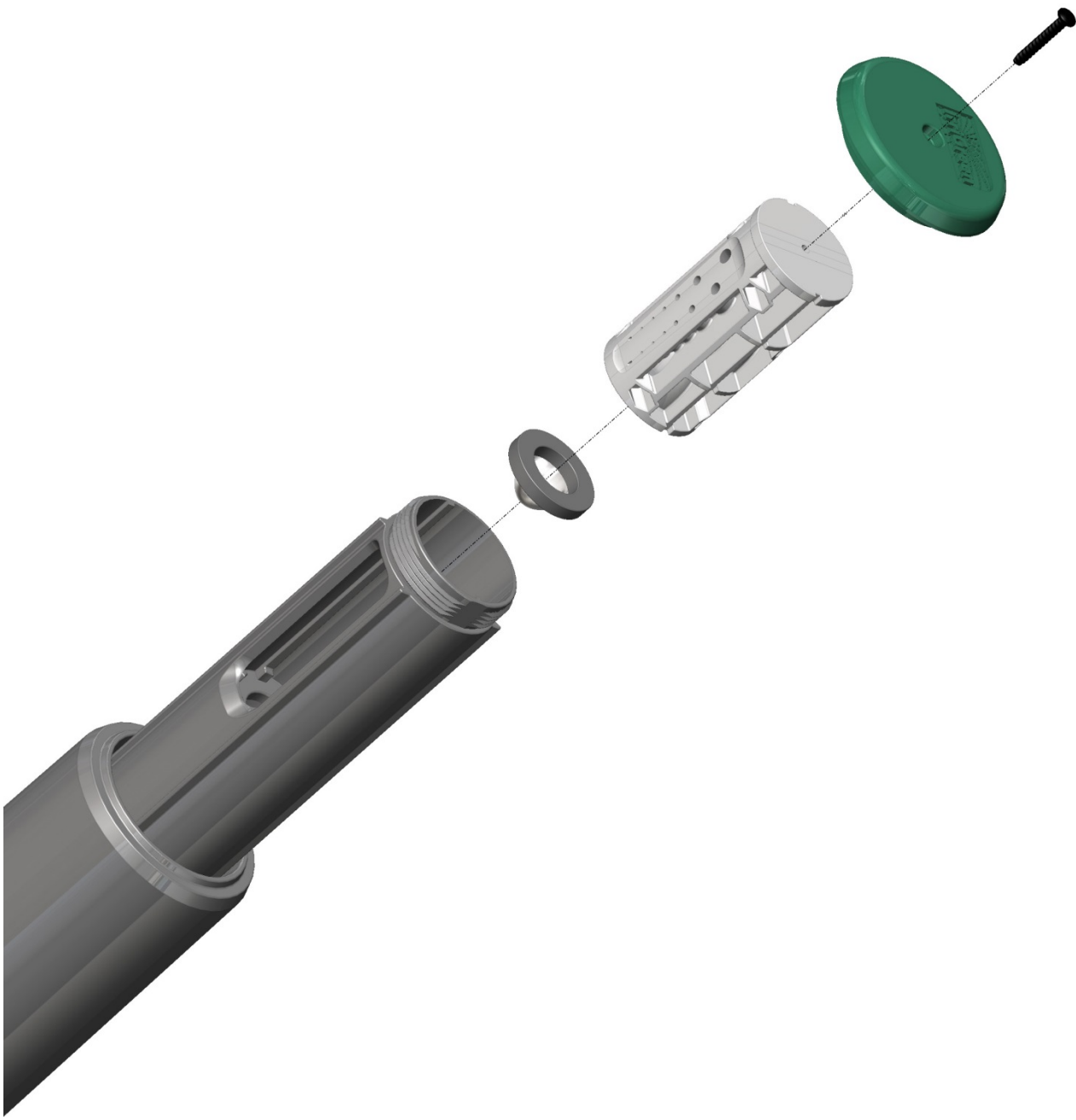



Warranty

**IRRIGREEN, LLC
LIMITED TWO YEAR WARRANTY – IRRIGREEN™ IRRIGATION PRODUCT**

Limited Warranty. IrriGreen, LLC ("we", "us", "our") warrants its irrigation product (consisting of sprinklers, server box and remote programmer) against defects in material and workmanship for a period of two years from the original date of purchase, provided they are used for irrigation purposes as intended by us in our specifications. Our product warranty is provided solely to the original end user ("you") of our products and is not transferable.

During the warranty period and upon proof of purchase, at our option, we will either repair or replace any part found to be defective, using new or refurbished parts, without charge. Our liability is limited solely to the repair or replacement of defective parts of our product. These are your sole and exclusive remedies for any breach of warranty. There are no other express warranties.

Our limited warranty only covers product issues caused by defects in material or workmanship during ordinary use during the limited warranty period. It does not cover product issues caused by any other reason including but not limited to defect or issues due to (i) acts of God (e.g. lightning, flooding, etc.); (ii) damage by accident, misuse, or abuse; (iii) customer installations or installations performed in any manner contrary to our specifications and instructions; (iv) limitations of technology; or (v) modifications or alterations of or to any part of our product unless done or approved by us. We are also not liable for failure of products not manufactured by us even though such products may be sold or used in conjunction with our products. Our warranty does not apply to software products contained in our product such software being provided AS IS or batteries used within our product.

Service Fees. Any service fees related to removing any defective part and/or re-installing repaired or replaced parts shall be at the end user's sole cost and expense unless the end user has a written service contract with us or with a certified IrriGreen irrigation system installer in which case such written contract will control regarding such service fees.

Warranty Service. To obtain the benefits of our warranty, you must contact your certified IrriGreen irrigation system installer and provide to them a copy of the original sales receipt or other proof of purchase within the warranty period. You or the certified installer are responsible for any damage to any part or loss resulting from removing any defective part or product and/or re-installing any repaired or replaced parts. For questions, you can call us at 612-238-7575.

Grounding. Our limited warranty for server boxes is void if the service box is not properly grounded per our manufacturer's specifications. It is the responsibility of the installer to connect all electronic irrigation equipment for which they are responsible to earth ground in accordance with the National Electrical Code (NEC). Even with optimum grounding, we are not liable for product failures due to acts of God (e.g. lightning, flooding, etc.) and these failures are not covered by this warranty.

WARRANTY EXCLUSIONS & LIMITATIONS. TO THE EXTENT PERMITTED BY LAW, THIS WARRANTY AND REMEDIES SET FORTH ABOVE ARE EXCLUSIVE AND IN LIEU OF ALL OTHER WARRANTIES, REMEDIES AND CONDITIONS, WHETHER ORAL OR WRITTEN, STATUTORY, EXPRESS OR IMPLIED. None of our resellers, certified installers, agents, or employees are authorized to make any modification, extension, or addition to this warranty.

EXCEPT TO THE EXTENT PROHIBITED BY APPLICABLE LAW, ANY IMPLIED WARRANTY OF MERCHANTABILITY OR FITNESS FOR A PARTICULAR PURPOSE ON THIS PRODUCT IS LIMITED IN DURATION TO THE DURATION OF THIS WARRANTY.

WE ARE NOT LIABLE FOR DIRECT, INDIRECT, INCIDENTAL OR CONSEQUENTIAL DAMAGES IN CONNECTION WITH THE USE OF OUR PRODUCTS, INCLUDING BUT NOT LIMITED TO: VEGETATION LOSS, THE COST OF SUBSTITUTE PARTS OR EQUIPMENT OR SERVICES REQUIRED DURING PERIODS OF MALFUNCTION OR RESULTING NON-USE, PROPERTY DAMAGE OR PERSONAL INJURY RESULTING FROM INSTALLER'S ACTIONS, WHETHER NEGLIGENT OR OTHERWISE, OR DAMAGE CAUSED BY A DEFECTIVE PART OR PRODUCT SUCH AS FLOODING.

Some states do not allow the exclusion or limitation of incidental or consequential damages or exclusions or limitations on the duration of implied warranties or conditions, so the above limitations or exclusions may not apply to you. This warranty gives you specific legal rights, and you may also have other rights that vary by state.

August 2013