



WIRELESS ACCESS POINT
PRODUCT MANUAL

Models:
AN-100-AP-I-N
AN-300-AP-I-N
AN-500-AP-I-AC
AN-700-AP-I-AC





1 - About this Manual

This manual was created to provide a reference for installers and end users of Araknis Networks™ products. It provides all known information regarding the installation, setup, use, and maintenance of the product. The symbols below are used to identify important information:



Pro Tip - Pro tips are included in sections of the manual to add information that provides extra value, utility, or ease-of-use for the installer or end user of the product. Pro tips may also link to extra information that will provide a better understanding of application, technology or use of the product or feature in question. These items are not required, but have been added for your convenience.



Note - Notes emphasize information important to the installation, setup, or use of the product that is not essential to follow for safety of the equipment or user. Notes may be located before or in the midst of the section to which they apply, depending on the type of information. These items usually contain essential information, like the size or dimension of a separate part required, or a critical step in the process, that, if missed, would cause the installer or end user extra work to overcome.



Caution - The caution symbol is used to indicate information vital to the safety of the equipment in use with the product, or the product itself. Cautions are always provided before the information they relate to. Not following a caution will almost always result in permanent damage to equipment that is not covered by warranty.



Warning - Warnings indicate information vital to the safety of the installer or end user of the product. Warnings are always provided before the information they relate to. Not following a warning may result in permanent damage to equipment and serious injury or death of the installer or end user.



Table of Contents

1 - About this Manual	2
2 - Welcome to Araknis Networks™	6
2.1 - Features	6
2.2 - Package Contents	6
3 - Hardware Overview	7
3.1 - Top	7
3.2 - Bottom	7
3.3 - Side	7
4 - Mounting Location - General Guidelines	8
5 - Wiring Requirements	9
5.1 - Network Cable Requirements	9
5.2 - PoE Requirements	9
5.3 - Power Requirements for Non-PoE Application	9
5.4 - Wiring Instructions	9
5.4.1 - Wiring Diagram	10
6 - Mounting the Access Point	11
6.1 - Table Top/Shelf	11
6.2 - Junction Box Mounting	11
6.2.1 - Instructions	11
6.3 - Wall or Ceiling Drywall Mounting Instructions	12
6.4 - Ceiling Tile Mounting Instructions	12
7 - Power-On and Operation	13
7.1 - Status LED Operation	13
8 - Introduction to Network Setup	14
9 - Accessing the Web Interface	14
9.1 - EZ Access Method (Default)	15
9.2 - Configured System Name Access	16
9.3 - DHCP/Static IP Address Method	17
9.3.1 - Finding the IP Address of the Access Point	17
9.3.2 - Default IP Address Access	18
10 - Web Interface Overview	21
10.1 - Applying Changes in the Web Interface	22
11 - Status Menu	23
11.1 - System Status	23
11.1.1 - System Information	24
11.1.2 - Wireless Information	25
11.1.3 - LAN Information	26
11.1.4 - System Log	27
11.1.4.1 - Using the System Log	27



11.2 - Wireless interface	28
11.2.1 - Radio Status	29
11.2.2 - Utilization of SSID	30
11.2.3 - Wireless Network	30
11.2.4 - Connected Clients	31
12 - Settings Menu	32
12.1 - System Settings	32
12.1.1 - System Information	33
12.1.2 - Date and Time Settings	34
12.1.3 - Time Zone	35
12.2 - LAN Settings	36
12.2.1 - IP Settings	37
12.2.2 - Interface Settings	38
12.3 - Wireless Settings	39
12.3.1 - Radio Settings	40
12.3.2 - Utilization of SSID	41
12.3.3 - Wireless Networks	42
12.3.4 - Wireless Security Menu	43
12.3.4.1 - WPA-PSK Mixed and WPA2-PSK Modes	43
12.3.4.2 - WPA and WPA2 Modes	44
12.3.5 - Guest Network	45
12.4 - Security Settings	47
12.4.1 - User Accounts	48
12.4.2 - Access Control	49
12.4.3 - Email Alert	50
12.4.4 - Device Discovery	52
12.5 - Schedule	53
12.5.1 - Auto Reboot Settings	54
12.5.2 - Auto Ping Gateway Settings	55
12.5.3 - Wi-Fi Scheduler	56
13 - Maintenance	58
13.1 - Ping Test	58
13.2 - Traceroute Test	59
13.3 - File Management	60
13.3.1 - Configuration File	61
13.3.1.1 - Backup Current Configuration	61
13.3.1.2 - Upload New Configuration File	61
13.3.1.3 - Restore Factory Defaults	62
13.3.1.4 - Hardware Factory Default	62
13.3.1.5 - Firmware	63
13.4 - Restart	64
13.5 - Logout	65



14 - Advanced Menu	66
14.1 - Advanced Wireless Settings	66
14.1.1 - Radio Settings	67
14.1.2 - Client Limit	68
14.2 - Wireless MAC Filter Settings	69
14.2.1 - MAC Filter Settings	69
14.2.2 - MAC Filter List	70
14.3 - WPS Settings	71
14.3.1 - Configuring WPS Connections	71
14.4 - Site Survey	72
14.4.1 - Select Interface	72
14.4.2 - Result	73
14.5 - Spectrum Analyzer	74
14.6 - Wireless Traffic Shaping Settings	75
14.7 - SNMP Settings	76
14.7.1 - SNMPv2 Settings	77
14.7.2 - SNMPv3 Settings	78
14.8 - Spanning Tree Settings	79
14.9 - VLAN Settings	80
14.10 - Rogue AP Detection	81
15 - Troubleshooting	82
15.1 - Hardware Reset Procedure	82
16 - Software Defaults	83
16.1 - Basic Menus	83
16.2 - Advanced Menus	84
17 - Table of Figures	85
18 - Specifications	87
19 - CE Warning	93
20 - AN-100-AP-I-N FCC Statement	93
21 - AN-300-AP-I-N FCC Statement	96
22 - AN-500/700-AP-I-N FCC Statement	100
23 - 2-Year Limited Warranty	104
24 - Contacting Technical Support	104



2 - Welcome to Araknis Networks™

Thank you for choosing an Araknis™ Wi-Fi access point. With sleek, unobtrusive housings, extensive features, unique easy setup, and convenient PoE power, these products are ideal for use in both residential and commercial applications.

2.1 - Features

Feature	AN-100-AP-I-N	AN-300-AP-I-N	AN-500-AP-I-N	AN-700-AP-I-N
2.4GHz Radio	Yes	Yes	Yes	Yes
5GHz Radio	No	Yes	No	Yes
Concurrent Dual-band	No	Yes	No	Yes
Gigabit Ethernet	No	Yes	No	Yes
PoE Standard	802.3af	802.3af/at	802.3af	802.3af/at
WiFi Standard	802.11 b/g/n	802.11 a/b/g/n	802.11 b/g/n	802.11 a/b/g/n
OvrC Enabled	Yes	Yes	Yes	Yes

2.2 - Package Contents

*Not Pictured: Wall Mount Template

Figure 1. Package Contents



WAP

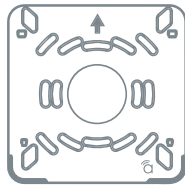

Mounting Bracket

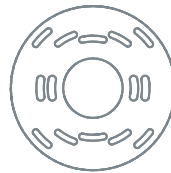

Tile Ceiling Backing Plate



Quick Start Guide



LAN Cable



Tile Ceiling Mounting Hardware



Drywall Mounting Hardware



3 - Hardware Overview

Use these images to familiarize yourself with the physical layout of your access point.

3.1 - Top

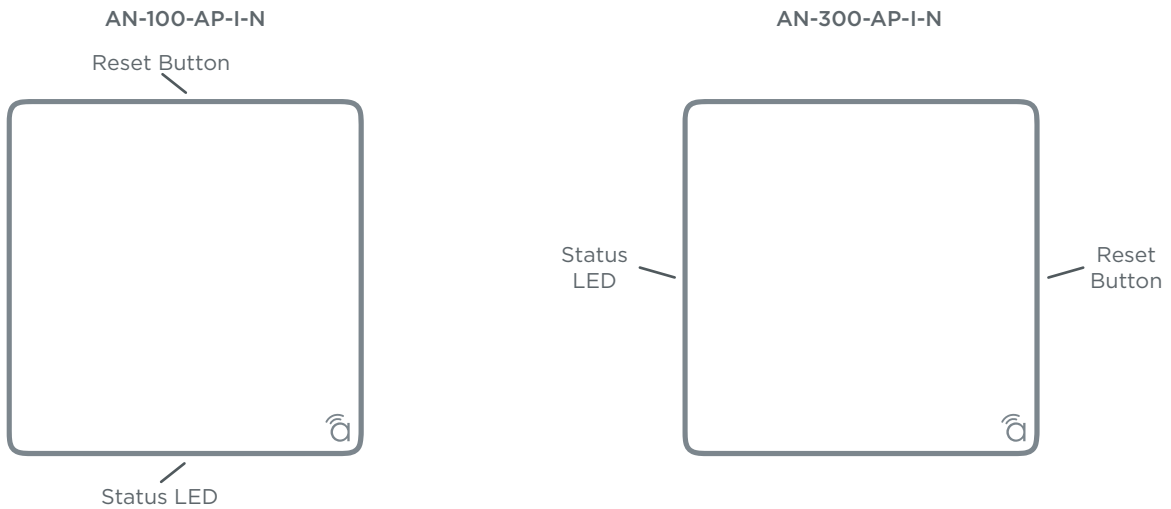

3.2 - Bottom

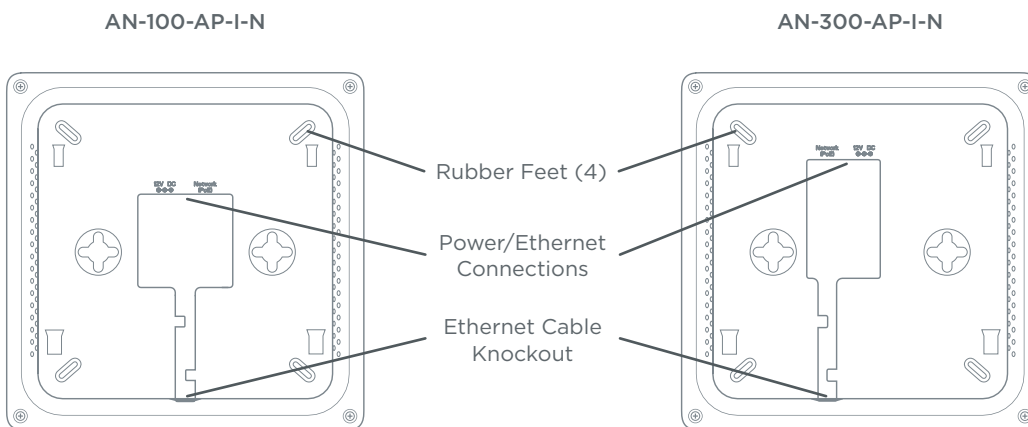

3.3 - Side

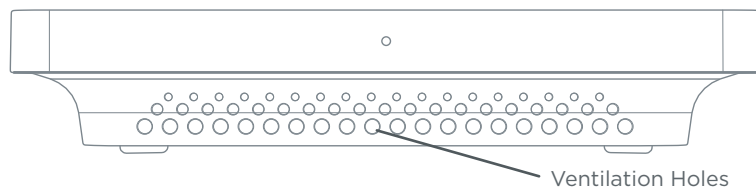



4 - Mounting Location - General Guidelines

- Locate the access point in a central location. Higher mounting can provide better coverage.
- Avoid mounting near kitchens or rooms with large appliances that may give off EMI noise, which can reduce connection speed, and in extreme cases, block WiFi connectivity altogether.
- As a rule of thumb, each access point can cover about a 300 ft (100m) radius (actual performance varies based on multiple variables).
- Plan multiple access points at least 200 ft apart. Signal should overlap but only slightly.
- Use network site survey tools (not included) to determine mounting locations if possible. This will ensure you get the best coverage and performance from your installation.



Pro Tip - Professional site survey tools are available from vendors in the market such as Metageek and Fluke Networks.

Figure 2. Residential Access Point Location

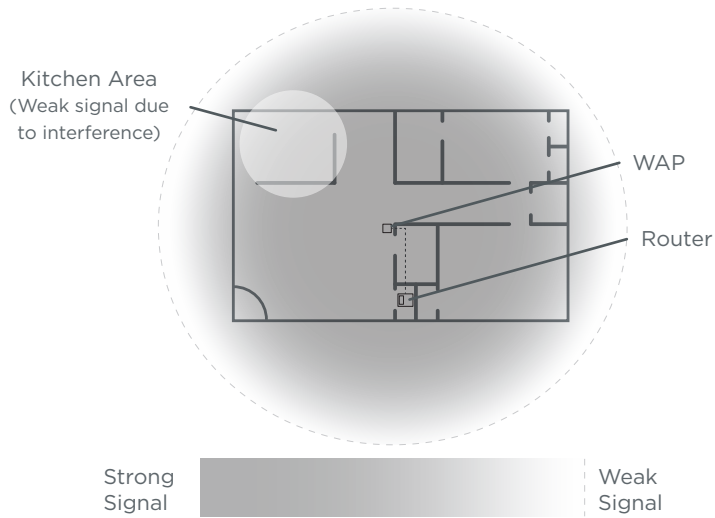
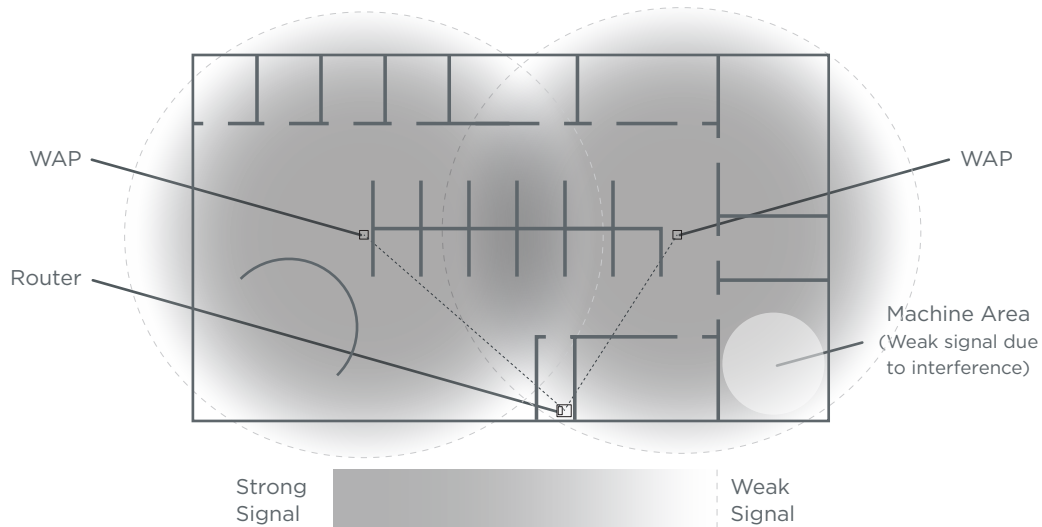

Figure 3. Small Commercial Access Point Location





5 - Wiring Requirements

The access point must be connected to the local network and powered using PoE (Power over Ethernet) or 12V DC power. Install the required cabling and equipment according to the guidelines in this section.

5.1 - Network Cable Requirements

568B termination is recommended (Figure 4. EIA/TIA 568B Termination Pattern) Connect a Cat5e/6 straight-through cable between the access point and a local area network port on a switch or router.

Figure 4. EIA/TIA 568B Termination Pattern



Pin 1	White/Orange	Pin 5	White/Blue
Pin 2	Orange	Pin 6	Green
Pin 3	White/Green	Pin 7	White/Brown
Pin 4	Blue	Pin 8	Brown

(Gold pins facing up)



Note - Maximum cable length is 328 feet (100m). A repeater device is required for longer runs.

5.2 - PoE Requirements



Caution - Use an 802.3af/at compliant PoE injector, switch, or router to power the access point. Non-compliant devices can harm the access point and lead to unpredictable results.

5.3 - Power Requirements for Non-PoE Application

If PoE is not being used, connect a suitable power supply (not included) from a nearby outlet to the DC input of the access point.

- **AC Outlet** - 100-240V AC, 50/60Hz (AN-100: 0.3A; AN-300: 0.6A)
- **DC Input** - 12V DC 1A (AN-100); 2A (AN-300).

5.4 - Wiring Instructions

Plan a mounting location and install the wiring before installing the access point.



Warning - Do not connect any equipment to the wiring until every connection has been terminated and testing is complete.

1. For PoE installations, install a network cable from the PoE device to the access point and terminate both ends to the same pattern. The DC power supply is not needed.
2. For non-PoE installations, locate an outlet for the power supply.



Pro Tip - If needed, extend a 2-conductor power wire from the power supply to the access point.



5.4.1 - Wiring Diagram

Figure 5. Network Wiring Diagram

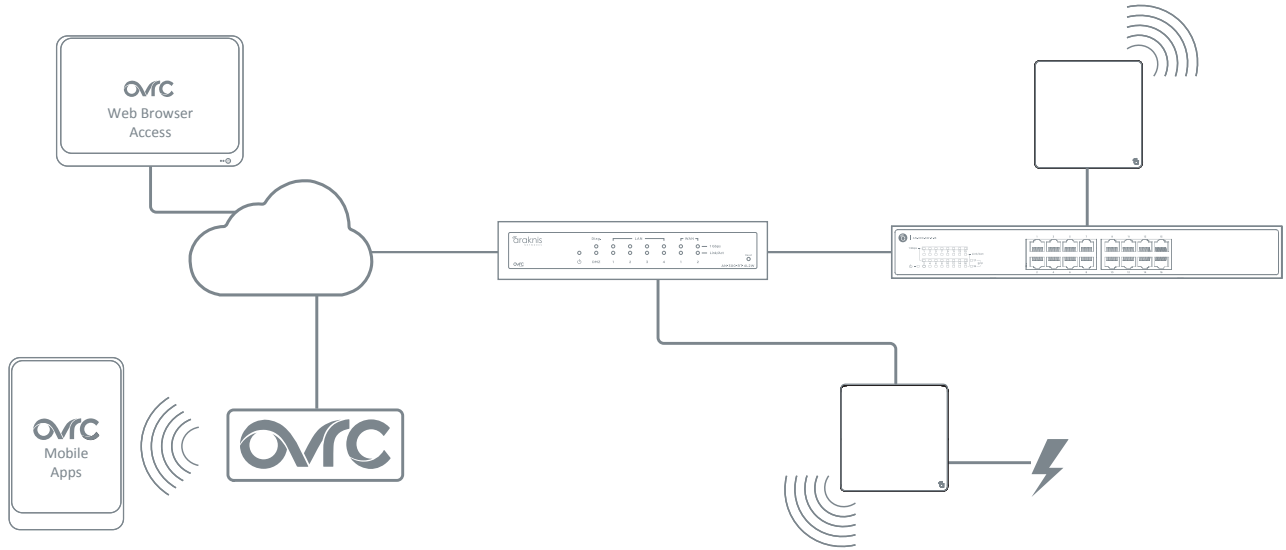

6 - Mounting the Access Point

6.1 - Table Top/Shelf

The access point comes with rubber feet installed for placement on flat surfaces. The mounting bracket is not required for this application.

6.2 - Junction Box Mounting

The mounting bracket is compatible with most common junction box and plaster ring dimensions, including common ceiling box sizes:

- Single/Double Gang
- 4" Square Box
- 3" Octagonal Box
- 4" Octagonal Box

6.2.1 - Instructions

1. Place the mounting bracket over the junction box and attach it loosely with 2 screws. (two 6-32 x 1" screws are included) Use the hole pattern on the bracket that best matches the box pattern. See Figure 5A.
2. Level or align the bracket with nearby objects for uniformity and tighten the screws enough to secure it. Avoid over-tightening and warping the bracket.
3. Connect the wiring to the access point and push any extra wiring back into the opening. See Figure 5B.
4. Snap the access point onto the bracket. See Figure 5C.

Figure 6. Junction Box Mounting

Figure 6A

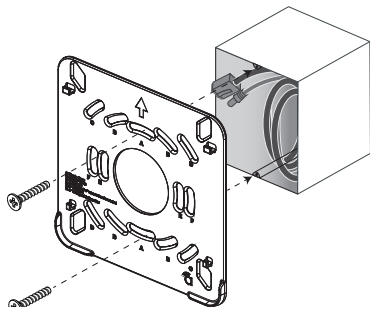

Figure 6B

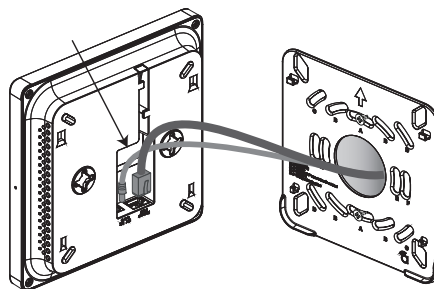
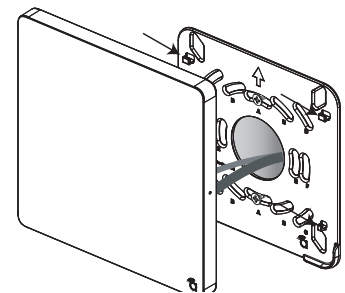

Figure 6C



6.3 - Wall or Ceiling Drywall Mounting Instructions

1. Place the bracket over the desired mounting location with the arrow on the bracket pointing up for wall mounting. See Figure 6A.
2. Mark the “C” or “D” slots on the mounting surface, then remove the bracket and thread one of the included drywall anchors into the center of each mark using a Phillips screwdriver.
3. Level or align the bracket with nearby objects and fasten it to the anchors using the two included anchor screws. Tighten the screws enough to secure the bracket. Avoid over-tightening and warping the bracket.
4. Connect the wiring to the access point and push any extra wiring back into the opening. See Figure 6B.
5. Snap the access point onto the bracket. See Figure 6C.

Figure 7. Drywall Mounting

Figure 7A

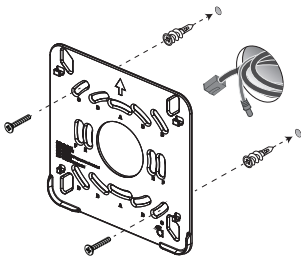

Figure 7B

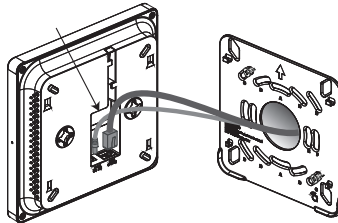
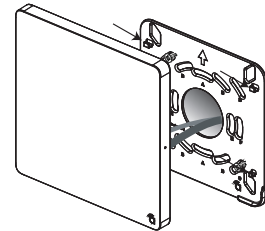

Figure 7C



6.4 - Ceiling Tile Mounting Instructions

1. Place the bracket over the desired mounting location and align it with nearby objects for uniformity.
2. Mark the “C” or “D” slots on the ceiling tile (and the center hole if needed for wiring).
3. Cut the opening with a keyhole saw. Use a drill to make clean holes for the mounting screws.
4. Place the ceiling backing plate and nuts on top of the tile as shown and fasten the mounting bracket to the tile using the included screws.
5. Connect the wiring to the access point and push any extra wiring back into the opening.
6. Snap the access point onto the bracket.

Figure 8. Ceiling Tile Mounting

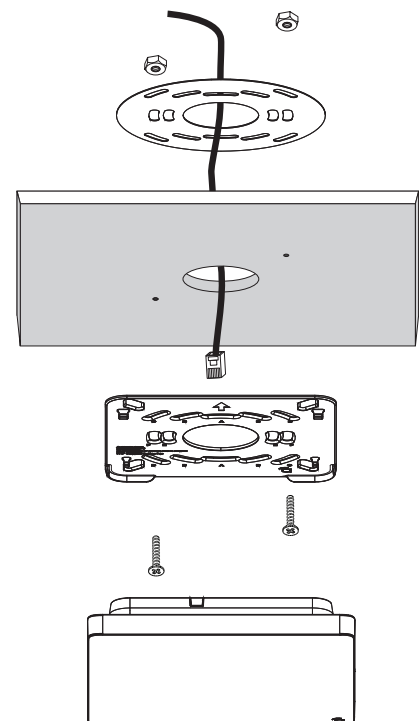



7 - Power-On and Operation

Once the access point is powered, the status LED can be used to determine proper operation.



Pro Tip – Check the wireless network connection status in your PC to see if the default SSID “araknis_initial” is being broadcast. If the SSID is being broadcast, you may continue to the next section to begin configuring device access and software setup.

7.1 - Status LED Operation

After installing the access point, connect the network and power cables and check the status LED. Once the LED remains illuminated (no more flashes), then the device is ready to be accessed for setup.

Figure 9. Status LED Location

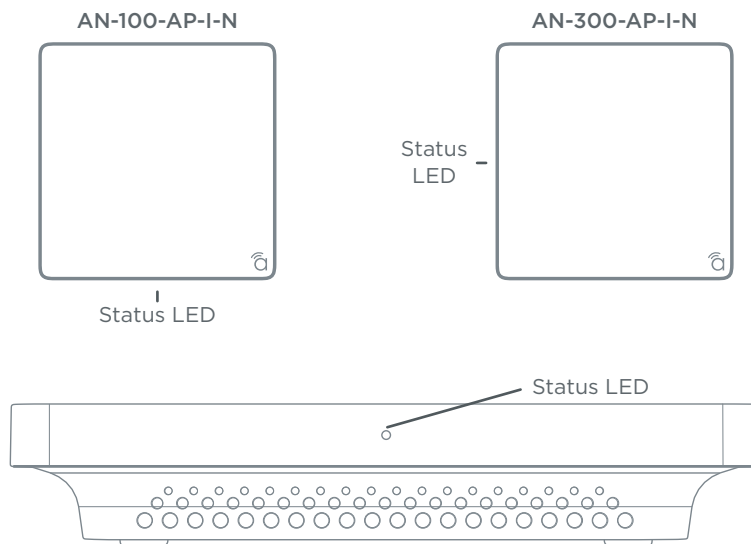

- Blue LED:
 - Blinking: Device is not working correctly. Refer to the Troubleshooting section.
 - Solid: Device is operating correctly.



8 - Introduction to Network Setup

The access point setup menu is used to make network configuration changes. This section explains how to access and use the menu.



Warning - All Araknis access points will transmit the same SSID, “araknis_initial” by default. If multiple access points are being installed in the same network, power on and complete network setup for one device at a time to avoid confusion about which access point you are connected to. Always change the SSID during initial setup.

9 - Accessing the Web Interface

There are several ways to access the web interface of the access point:

- **EZ Access Method** - Default method used for initial setup. Connect your computer to the access point using Wi-Fi.
- **Configured System Name Access** - Enter the device name instead of the IP address to access the web interface.
- **DHCP/Static IP Address Method** - Can be used any time. Connect your computer to the network wired or wirelessly and enter the IP address issued to the access point by the network, or the default IP address, (192.168.20.253).
- **OvrC Method** - OvrC gives you remote device management, real-time notifications, and intuitive customer management, right from your computer or mobile device. Setup is plug-and-play, with no port forwarding or DDNS address required. To add this device to your OvrC account:
 1. Connect the WAP to the Internet
 2. Log Into OvrC (www.ovrc.com)
 3. Add the Device (MAC address and Service Tag numbers needed for authentication)

9.1 - EZ Access Method (Default)

When the WAP is powered on for the first time, it transmits the default, unsecured SSID, “araknis_initial”. Connect and access the web interface without any cable connections or network card setting changes.

Note - Make sure the WAP is connected to a network with a functioning DHCP server. After the WAP is powered on, startup usually takes two to four minutes to complete. Wait for the Status LED to turn solid before beginning setup.

Figure 10. Default SSID

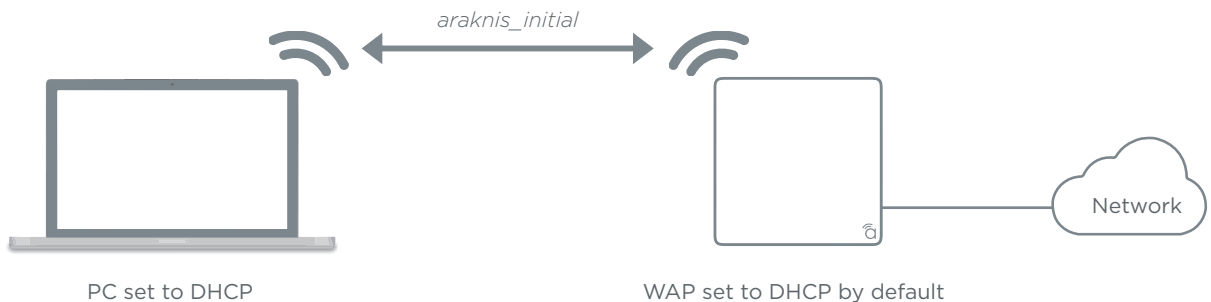

On your wireless network-enabled computer:

1. Disconnect any network cables from your computer.
2. Make sure the wireless network card is set to obtain an IP address automatically (DHCP mode).
3. Connect your computer to the wireless network named “araknis_initial”.
4. Open a web browser and enter the configuration address for your device:
 - AN-100-AP-I-N enter: ***http://config.an100.wap/***
 - AN-300-AP-I-N enter: ***http://config.an300.wap/***
5. Enter the default login credentials:
 - Username: ***araknis***
 - Password: ***araknis***

Figure 11. EZ Setup Login Screen

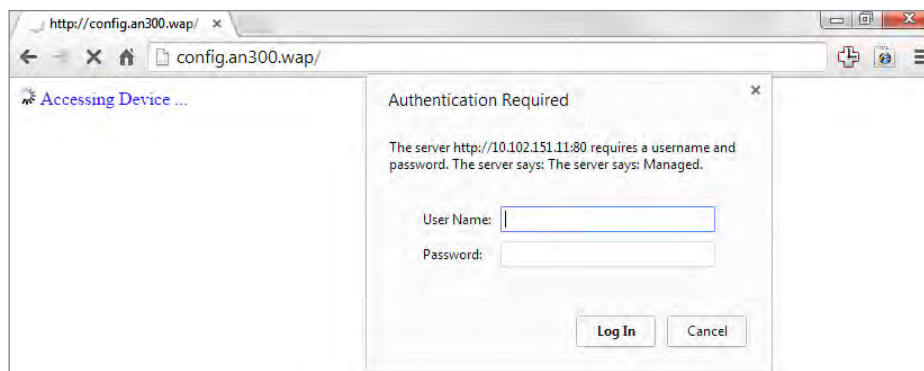



9.2 - Configured System Name Access

Note - “Araknis EZ Access” on page 52 must be enabled for this access method to work. The setting is enabled by default.

1. See section “12.1 - System Settings” on page 32 to set the system name.
2. Apply the settings. After configuration, the WAP web interface may be accessed using the system name.
3. Open a web browser and enter the configuration address for your WAP in this format (Example System Name = *smith100*):
 - Enter into address bar: *http://config.smith100.wap/*
4. Enter the login credentials. (Default: *araknis/araknis*)

Figure 12. System Name Access

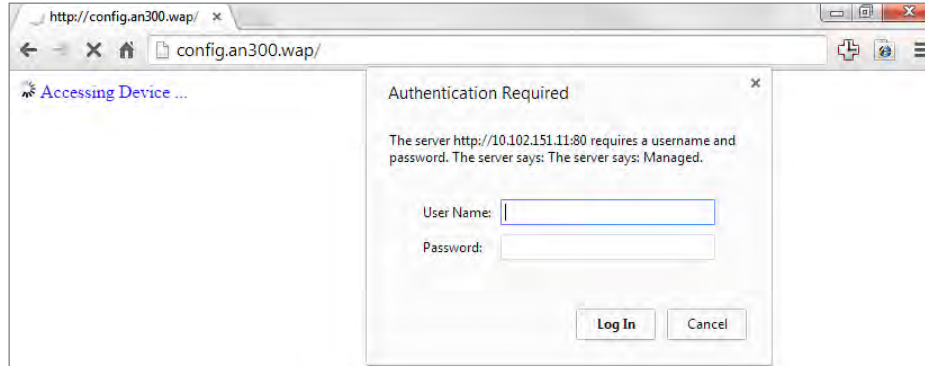

9.3 - DHCP/Static IP Address Method

Connect your computer to the network wired or wirelessly and enter the IP address issued to the access point by the network, or the default IP address, 192.168.20.253.

Note - If the WAP is not issued a DHCP IP address on the network, access the device using the default IP address.

9.3.1 - Finding the IP Address of the Access Point

The WAP is configured to DHCP by default so that the DHCP server can assign an IP address when the WAP is connected to the network (the DHCP server is usually the router). This address can be used for accessing the web interface.

1. Use one of these methods to find the IP address of the WAP:
 - Check the client table on your router
 - Use a network scanner (e.g. Fing) to sniff the network. The Araknis WAP manufacturer field will display **Snap AV**.
 - See the highlighted field in the figure below for an example of an Araknis device being identified.

Figure 13. Fing IP Scanner Example

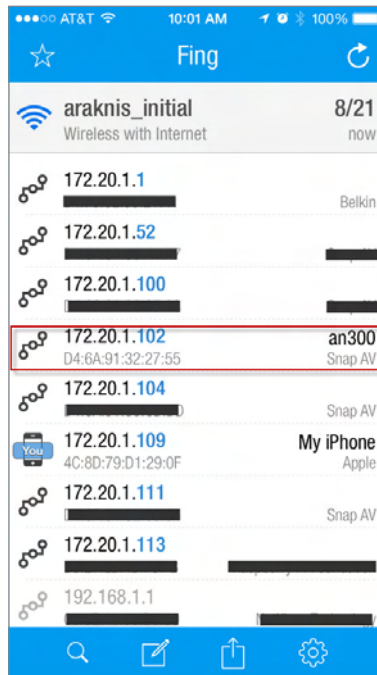

2. Once the IP address is found, enter it in your web browser and log in. (Default: *araknis/araknis*)

9.3.2 - Default IP Address Access

Access the interface using the default IP address, **192.168.20.253**. Use this method if the access point is not issued an IP address on the network or if access is required while not connected to a network.

1. Connect your PC to the WAP using a network patch cable.



2. On your PC, open the Control Panel and left-click **Network and Internet**.

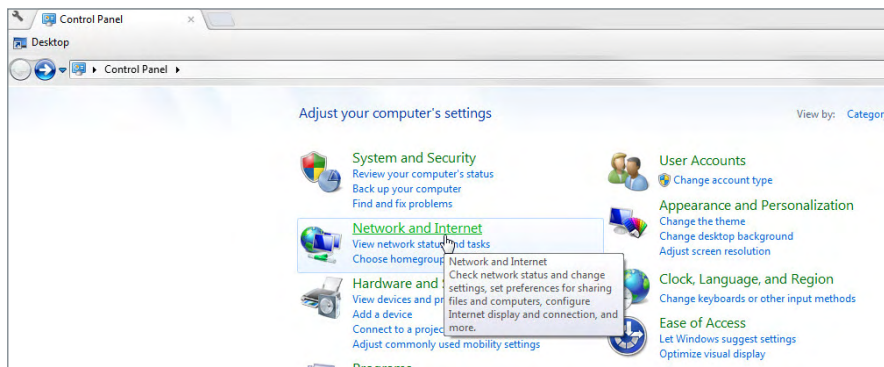

3. Left-click **Network and Sharing Center**.

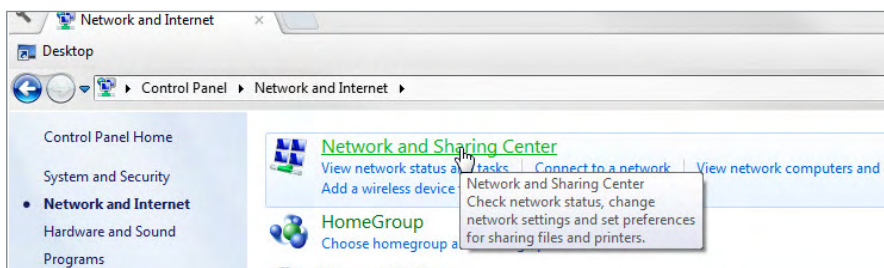

4. In the left bar, left-click **Change adapter settings**.

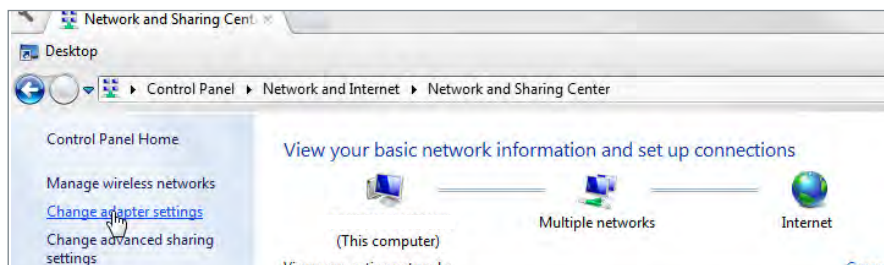

5. Right-click the icon for the wired network connection and left-click **Properties**.

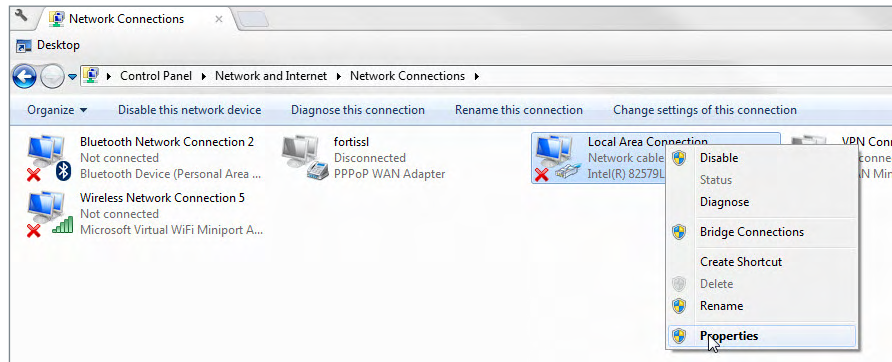

6. Left-click to highlight **Internet Protocol Version 4 (TCP/IPv4)**, then left-click **Properties**.

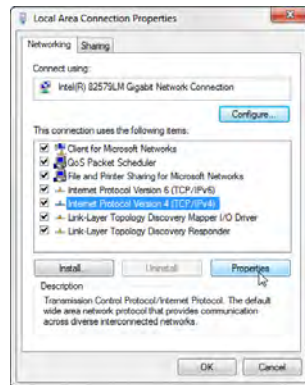

7. In the General tab, left-click **Use the following IP address:** and enter the IP address and subnet mask.

- IP Address: **192.168.20.2**
- Subnet Mask: **255.255.255.0**





- Left-click **OK** to close **Internet Protocol Version 4 (TCP/IPv4) Properties**, then left-click **OK** to close **Wireless Network Connection Properties**.

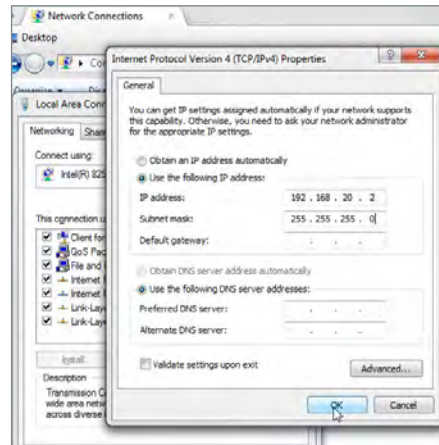

- Open a web browser and navigate to <http://192.168.20.253/>. Log in using the default credentials:
 - Username: *araknis*
 - Password: *araknis*

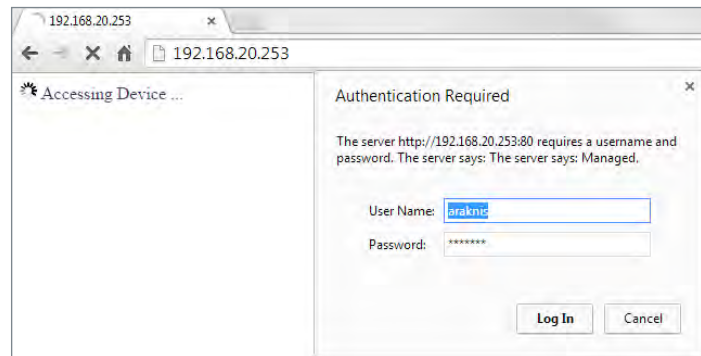



10 - Web Interface Overview

Figure 14. Web Interface Layout

The screenshot shows the Araknis Networks web interface. On the left is a navigation menu (A) with sections: STATUS (selected), SETTINGS, MAINTENANCE, and ADVANCED. The main content area (B) displays the SYSTEM STATUS page, which is divided into three sections: System Information, Wireless Information, and LAN Information. The top bar (C) shows connection status, system time, and uptime.

SYSTEM STATUS			
System Information			
System Name	smith100		
Service Tag			
Firmware Version	1.1.00		
Management VLAN ID	Untagged		
Wireless Information			
	2.4GHz	5GHz	
MAC Address	88:DC:96:1D:33:69	88:DC:96:1D:33:6A	
Number of Networks	1	1	
Number of Connected Clients	2	0	
Operation Mode	Access Point	Access Point	
TX	2394778880 Bytes	353714816 Bytes	
RX	971170176 Bytes	151871360 Bytes	
LAN Information			
Speed	1Gbps	IP Address	192.168.1.20
Duplex	Full	Subnet Mask	255.255.255.0
MAC Address	88:DC:96:1D:33:68	Default Gateway	192.168.1.1
TX	1014819328 Bytes	Primary DNS	192.168.1.1
RX	201073072 Bytes	Secondary DNS	8.8.8.8

- **A - Main Navigation Menu**
Use the submenus under the Status, Settings, Maintenance, and Advanced headings to configure and maintain the access point. Click **Apply Changes** to review and apply changes made in menus.
- **B - Main Window**
The main window displays the currently selected submenu.
- **C - Top Bar**
The top bar displays the current connection status to the OvrC server, the current internally-set system time, and the current system uptime in DAYS:HOURS:MINUTES.

10.1 - Applying Changes in the Web Interface

1. After making changes to settings on a menu page, left-click the **Save** button on the menu to hold the new settings in the Apply Changes field.
2. After all desired changes have been made, left-click **Apply Changes** to review the new settings. Left-click **Apply** to make the changes or **Revert** to cancel the changes.

Figure 15. Applying Changes

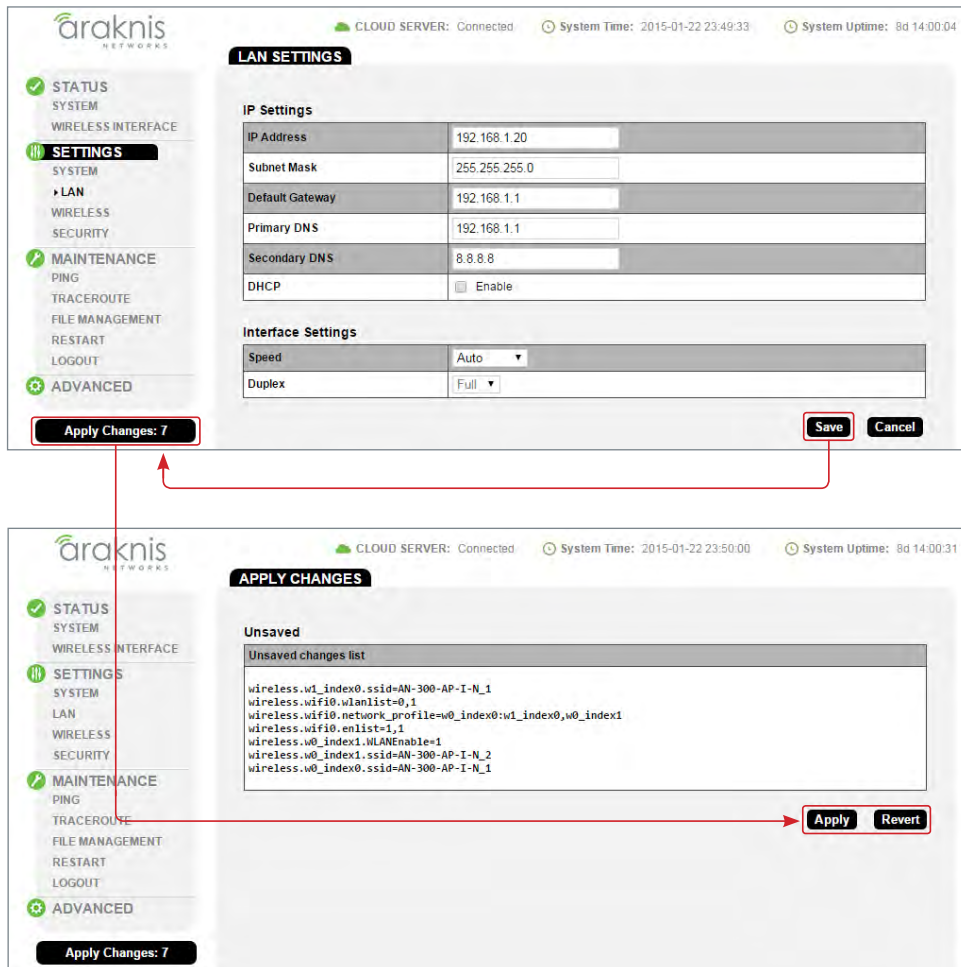

11 - Status Menu

11.1 - System Status

The System Status screen provides a real-time summary of access point system information, and is the first screen that appears when you log into the access point web interface. Use the screen to verify settings and operation of your device.

Note - The figures displayed use AN-300-AP-I-N screenshots. AN-100 interfaces will indicate settings and information only for the 2.4GHz channel. The AN-300 will indicate settings and information for the 2.4GHz and 5GHz channels.

Figure 16. System Status Screen

The screenshot displays the 'SYSTEM STATUS' screen in the Araknis Networks web interface. The top navigation bar includes 'STATUS' (selected), 'SYSTEM', 'WIRELESS INTERFACE', 'SETTINGS', 'LAN', 'WIRELESS', 'SECURITY', 'SCHEDULE', 'MAINTENANCE', 'PING', 'TRACEROUTE', 'FILE MANAGEMENT', 'RESTART', 'LOG OUT', and 'ADVANCED'. A 'Apply Changes: 0' button is visible below the menu.

SYSTEM STATUS

System Information

System Name	smith100	
Service Tag		
Firmware Version	1.1.00	
Management VLAN ID	Untagged	

Wireless Information

	2.4GHz	5GHz
MAC Address	88:DC:96:1D:33:69	88:DC:96:1D:33:6A
Number of Networks	1	1
Number of Connected Clients	2	0
Operation Mode	Access Point	Access Point
TX	2394778880 Bytes	353714816 Bytes
RX	971170176 Bytes	151871360 Bytes

LAN Information

Speed	1Gbps	IP Address	192.168.1.20
Duplex	Full	Subnet Mask	255.255.255.0
MAC Address	88:DC:96:1D:33:68	Default Gateway	192.168.1.1
TX	1014819328 Bytes	Primary DNS	192.168.1.1
RX	201073072 Bytes	Secondary DNS	8.8.8.8

System Log

```

Sep  8 19:14:37 AN300 daemon.info hostapd: ath0: STA 80:d2:1d:13:12:b6 WPA: group key handshake completed (RSN)
Sep  8 19:14:37 AN300 daemon.info hostapd: ath0: STA 9c:b7:0d:64:0b:2d WPA: group key handshake completed (RSN)
Sep  8 18:14:58 AN300 daemon.info hostapd: ath0: STA 9c:b7:0d:64:0b:2d WPA: pairwise key handshake completed (RSN)
Sep  8 18:14:58 AN300 user.warn kernel: [ieee80211_ioctl_setmlme] non sta mode, skip to set ssid
Sep  8 18:14:58 AN300 user.warn kernel: Node Added (NC = 2)
Sep  8 18:14:58 AN300 daemon.info hostapd: ath0: STA 9c:b7:0d:64:0b:2d IEEE 802.11: associated
Sep  8 18:14:46 AN300 daemon.info hostapd: ath0: STA 34:02:86:bb:32:fd IEEE 802.11: deauthenticated due to local death request
Sep  8 18:14:45 AN300 user.warn kernel: Node deleted (NC = 0)
Sep  8 18:14:45 AN300 daemon.info hostapd: ath50: STA 34:02:86:bb:32:fd IEEE 802.11: disassociated
Sep  8 18:14:37 AN300 daemon.info hostapd: ath0: STA 80:d2:1d:13:12:b6 WPA: group key handshake completed (RSN)
Sep  8 17:51:11 AN300 user.warn kernel: Node deleted (NC = 1)
    
```

Buttons: Save Log, Clear Log

Path - Status, System



11.1.1 - System Information

Displays current information about the WAP's system settings.

Figure 17. System Information Table

System Information	
System Name	smith100
Service Tag	
Firmware Version	1.1.00
Management VLAN ID	Untagged

Path - Status, System, System Information

Parameters -

- **System Name** - Name assigned to the system. Used for configured name access.
- **Service Tag** - Internal tracking number used to track every product sold by Araknis Networks.
- **Firmware Version** - Current version of firmware running on the access point.
- **Management VLAN ID** - VLAN that must be used to access the web interface.



11.1.2 - Wireless Information

Displays current information about the wireless radio channel(s) in use.

Figure 18. Wireless Information

Wireless Information		
	2.4GHz	5GHz
MAC Address	88:DC:96:1D:33:69	88:DC:96:1D:33:6A
Number of Networks	1	1
Number of Connected Clients	2	0
Operation Mode	Access Point	Access Point
TX	2394778880 Bytes	353714816 Bytes
RX	971170176 Bytes	151871360 Bytes

Path – Status, System, Wireless Information

Parameters –



Note – The AN-100 will indicate settings and information for the 2.4GHz channel. The AN-300 will indicate settings and information for the 2.4GHz and 5GHz channels.

- **MAC Address** – Media Access Control (MAC) address. The 2.4GHz and 5GHz channels each have individual MAC addresses.
- **Number of Networks** – Number of active wireless networks (i.e. SSID's) configured on the radio interface.
- **Number of Connected Clients** – Number of currently connected wireless clients on all configured networks using the radio interface.
- **Operation Mode** – Indicates that the device is set up as a Wi-Fi access point.
- **TX** – Amount of data, in bytes, transmitted on the respective radio interface since the last power cycle.
- **RX** – Amount of data, in bytes, received on the respective radio interface since the last power cycle.



11.1.3 - LAN Information

Displays current LAN connection parameters.

Figure 19. LAN Information

LAN Information			
Speed	1Gbps	IP Address	192.168.1.20
Duplex	Full	Subnet Mask	255.255.255.0
MAC Address	88:DC:96:1D:33:68	Default Gateway	192.168.1.1
TX	1014819328 Bytes	Primary DNS	192.168.1.1
RX	201073072 Bytes	Secondary DNS	8.8.8.8

Path – Status, System, LAN Information

Parameters –

- **Speed** – Indicates negotiated LAN speed between the access point and the wired network.
- **Duplex** – Indicates the negotiated duplex setting between the access point and the wired network.
- **MAC address** – The MAC address assigned to the access point network connection. This address may also be found on the access point's service tag.
- **TX** – Amount of data, in bytes, transmitted over the wired network connection.
- **RX** – Amount of data, in bytes, received from the wired network connection.
- **IP Address** – Access point IP address issued by the network router.
- **Subnet Mask** – Access point subnet mask.
- **Default Gateway** – Network router IP address.
- **Primary DNS** – Indicates the primary DNS for the AN-100/300.
- **Secondary DNS** – Indicates the secondary DNS for the AN-100/300.



11.1.4 - System Log

Records all activity within the access point. The table refreshes to show the most recent activity when the System Status Page is opened.

Figure 20. System Log

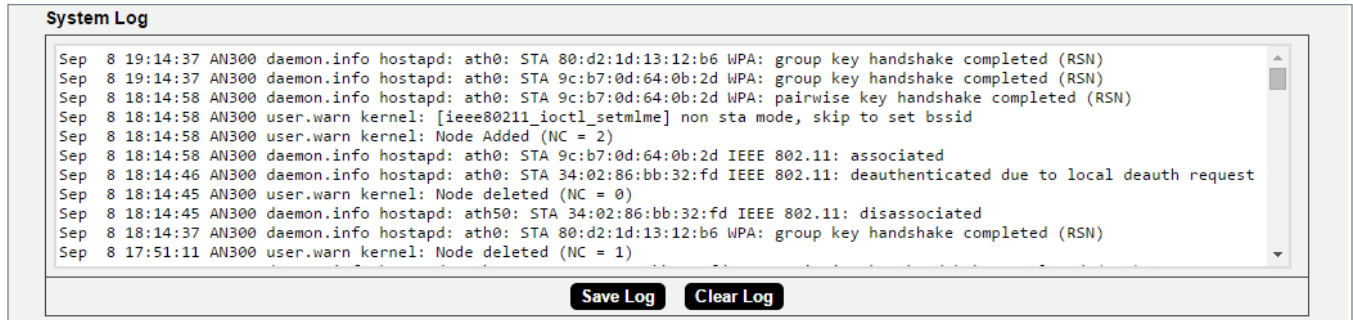

Path – Status, System, System Log

Parameters –

- **System Log** – The System Log records changes to access point configuration, connections, security conditions, and more. The window will refresh with the most current activity when the System Status Page is opened.

11.1.4.1 - Using the System Log

- **Save Log** – Click to view the log as a text file or save the log for future reference.
- **Clear Log** – Click to permanently delete to contents of the System Log.



11.2 - Wireless interface

Provides a detailed look at wireless settings and performance for radio status and settings, wireless network configuration and connected client status.

Figure 21. Wireless Interface Status

WIRELESS INTERFACE STATUS

CLOUD SERVER: Connected System Time: 2015-09-09 08:09:00 System Uptime: 14d 15:55:39

Radio Status

	2.4GHz	5GHz
Interface Status	Enabled	Enabled
Operation Mode	Access Point	Access Point
Wireless Mode	802.11 B/G/N	802.11 A/N
Channel Bandwidth	20MHz	40MHz
Channel Selection	Auto	Auto
Operating Channel	Channel 1	Channel 48
Channel Frequency	2.412 GHz	5.24 GHz
TX	2803286016 Bytes	431986592 Bytes
RX	1097777792 Bytes	159262528 Bytes

Utilization of SSID

	2.4GHz	5GHz
SSID's Used	1	1
SSID's Available	7	7

Wireless Network

Wireless Network(SSID) ▲	Enabled	Interface	Security ?	VLAN ID	MAC Address	Broadcast SSID ?	Client Isolation ?
AN-100-AP-I-N_1	Yes	2.4GHz	WPA2/PSK AES		88:DC:96:1D:33:69	Yes	No
AN-100-AP-I-N_1	Yes	5GHz	WPA2/PSK AES		88:DC:96:1D:33:6A	Yes	No

Connected Clients Refresh

Wireless Network(SSID) ◆	Device Name ◆	MAC Address ◆	TX(KBytes) ◆	RX(KBytes) ◆	RSSI(dBm) ◆	Release
AN-100-AP-I-N_1	Chromecast	80:D2:1D:13:12:B6	38954	3285	-45	Yes
	WhisonantE6520	9C:B7:0D:64:0B:2D				Yes

Apply Changes: 0 Save Cancel

Path - Status, Wireless interface



11.2.1 - Radio Status

Provides a detailed look at radio settings and performance.

Figure 22. Radio Status

Radio Status		
	2.4GHz	5GHz
Interface Status	Enabled	Enabled
Operation Mode	Access Point	Access Point
Wireless Mode	802.11 B/G/N	802.11 A/N
Channel Bandwidth	20MHz	40MHz
Channel Selection	Auto	Auto
Operating Channel	Channel 1	Channel 48
Channel Frequency	2.412 GHz	5.24 GHz
TX	2803286016 Bytes	431986592 Bytes
RX	109777792 Bytes	159262528 Bytes

Path – Status, Wireless interface, Radio Status

Parameters –



Note – The AN-100 will indicate settings and information for the 2.4GHz channel. The AN-300 will indicate settings and information for the 2.4GHz and 5GHz channels.

- **Interface Status** – Indicates whether the 2.4/5GHz wireless interface is enabled or disabled.
- **Operation Mode** – Access Point is the only mode currently supported.
- **Wireless Mode** – Indicates whether the wireless channel is in 802.11b/g/n or 802.11a/n mode.
- **Channel Bandwidth** – Set the bandwidth of the operating channel to 20MHz or 40MHz.
- **Channel Selection** – Select auto or manual channel selection mode of the wireless interface.
- **Operating Channel** – Indicates the selected channel for the wireless interface.
- **Channel Frequency** – Indicates the frequency of the selected channel.
- **TX** – Amount of data, in bytes, transmitted on each radio interface.
- **RX** – Amount of data, in bytes, received on each radio interface.



11.2.2 - Utilization of SSID

Details the use and availability of SSID's configured in the WAP.

Figure 23. Utilization of SSID Status

Utilization of SSID		
	2.4GHz	5GHz
SSID's Used	1	1
SSID's Available	7	7

Path – Status, Wireless interface, Wireless Network

Parameters –

Note – The AN-100 will indicate settings and information for the 2.4GHz channel. The AN-300 will indicate settings and information for the 2.4GHz and 5GHz channels.

- **SSID's Used** – Number of SSID's currently in use by devices connected to the access point.
- **SSID's Available** – Number of SSID's

11.2.3 - Wireless Network

The Wireless Network table provides a detailed look at wireless network settings.

Figure 24. Wireless Network Status

Wireless Network							
Wireless Network(SSID) ▲	Enabled	Interface	Security ?	VLAN ID	MAC Address	Broadcast SSID ?	Client Isolation ?
AN-100-AP-I-N_1	Yes	2.4GHz	WPA2/PSK AES		88:DC:96:1D:33:69	Yes	No

Path – Status, Wireless interface, Wireless Network

Parameters –

Note – The AN-100 will indicate settings and information for the 2.4GHz channel. The AN-300 will indicate settings and information for the 2.4GHz and 5GHz channels.

- **Wireless Network (SSID)** – Network names (SSID's) being transmitted by the access point.
- **Enabled** – Indicates whether the wireless network is enabled or disabled.
- **Interface** – Indicates the operating frequency of the wireless network.
- **Security** – Indicates the security mode selected for the wireless network.
- **VLAN ID** – Indicates the VLAN ID for the wireless network.
- **MAC address** – MAC address of the wireless channel used by the network.
- **Broadcast SSID** – Indicates whether the SSID is visible to Wi-Fi devices and discovery tools.
- **Channel Isolation** – Indicates whether access point client devices connected to different SSID's can communicate with each other.

11.2.4 - Connected Clients

The Connected Clients table provides a detailed look at connected wireless clients. All devices connected to any SSID on the access point will be displayed in the list.

Figure 25. Connected Client Status

Connected Clients							Refresh
Wireless Network (SSID) ▾		Device Name ▾	MAC Address ▾	Tx(KBytes) ▾	Rx(KBytes) ▾	RSSI(dBm) ▾	Release
AN-100-AP-I-N_1	●	Chromecast	80:D2:1D:13:12:B6	38954	3285	-45	Yes
	⬇	WhisonantE6520	9C:B7:0D:64:0B:2D				Yes

Path – Status, Wireless interface, Connected Clients

Parameters –

- **Wireless Network (SSID)** - Indicates the SSID being used by a connected wireless client.
- **Interface** - Indicates the channel frequency of a connected wireless client.
- **MAC address** - Indicates the MAC address of a connected wireless client.
- **TX (KBytes)** - Amount of data, in kilobytes, transmitted to a connected wireless client.
- **RX (KBytes)** - Amount of data, in kilobytes, received from a connected wireless client.
- **RSSI (dBm)** - Indicates the wireless signal strength between the access point and the connected client. The color of the table field indicates signal quality: green=strong, yellow=medium, and red=weak.
- **Release** - Click the **Yes** button to drop a client from the network.

i **Pro Tip** – The closer RSSI (dBm) value is to 0, the stronger the signal is, and the closer to -100, the weaker the signal is.



12 - Settings Menu

12.1 - System Settings

The System Settings screen allows configuration of basic system settings.

Figure 26. System Settings

SYSTEM SETTINGS

System Information

System Name	smith100
Admin Username	admin
Admin Current Password	
Admin New Password	
Confirm Admin New Password	
System LED	<input checked="" type="radio"/> ON <input type="radio"/> OFF
Management VLAN	<input checked="" type="radio"/> Untagged <input type="radio"/> Tagged 4096
Country	United States

Date and Time Settings

Manually Set Date and Time

Date: 2015 / 09 / 09

Time: 08 : 20 (24-Hour)

Synchronize with PC

Automatically Get Date and Time

NTP Server: time.nist.gov

Time Zone

Time Zone: UTC-05:00 Eastern Time (US & Canada)

Enable Daylight Saving

Start: March 2nd Sun 02:00

End: November 1st Sun 02:00

Save Cancel

Path - Settings, System



12.1.1 - System Information

The System Information screen allows configuration of admin and access settings.

Figure 27. System Information

System Information	
System Name	<input type="text" value="smith100"/>
Admin Username	<input type="text" value="admin"/>
Admin Current Password	<input type="password"/>
Admin New Password	<input type="password"/>
Confirm Admin New Password	<input type="password"/>
System LED	<input checked="" type="radio"/> ON <input type="radio"/> OFF
Management VLAN	<input checked="" type="radio"/> Untagged <input type="radio"/> Tagged <input type="text" value="4096"/>
Country	<input type="text" value="United States"/>

Path – Settings, System, System Information

Parameters –

- **System Name** – Enter a meaningful name such as *SmithHome* or *SmithBasement*. Limited to 32 characters, including spaces. Can be used for system name access. See section “9.2 - Configured System Name Access” on page 16.
- **Admin Username** – Enter a username for logging into the access point. Use letters, numbers, or punctuation. Limited to 32 characters, including spaces.
Default: araknis
- **Admin Current Password** – Enter the current login password when changing the password.
Default: araknis
- **Admin New Password** – Enter a new login password. Use letters, numbers, or punctuation. Limited to 32 characters, including spaces.
- **Confirm Admin New Password** – Confirm a new login password (enter same password as above).
- **System LED** – Turn the Status LED ON or OFF.
Default: ON
- **Management VLAN** – The VLAN ID from where the WAP web interface must be accessed. If Management VLAN=10, your computer must also be on VLAN 10.
Default: Untagged



Caution – Changing the management VLAN may cause a loss of access to the web interface. Move the computer to the new management VLAN or reset the WAP to regain connectivity (see section “13.3.1.4 - Hardware Factory Default” on page 62).

- **Country** – Select the country of the install location to comply with local standards.
Default: United States

Configuration Instructions –

1. Click **Settings, System**.
2. Specify the system information settings.
3. Click **Save**, then click **Apply Changes** to enable the new settings.



12.1.2 - Date and Time Settings

The Date and Time menu allows configuration of the 'real world' time setting and how it is kept correct for all access point functions.

Figure 28. Date and Time Settings

Date and Time Settings

Manually Set Date and Time

Date: 2015 / 09 / 09

Time: 08 : 20 (24-Hour)

Synchronize with PC

Automatically Get Date and Time

NTP Server: time.nist.gov

Path – Settings, System, Date and Time Settings

Parameters –

- **Manually Set Date and Time** – Select to manually set date and time.
 - **Date** – Enter the year, month and date (four digits for year; two digits for month, two digits for date)
 - **Time** – Enter the hour and minutes for the correct current time. Use a mobile device or satellite clock for accuracy.
- **Synchronize with PC** – Click this button to automatically sync the access point to a connected computer.
- **Automatically Get Date and Time** – Select to automatically get date and time from various web resources.
 - **NTP Server** – Select an NTP (Network Time Protocol) Server to set reference standard date and time.
Default: time.nist.gov.

Configuration Instructions –

1. Click **Settings, System.**
2. Specify the date and time settings.
3. Click **Save**, then click **Apply Changes** to enable the new settings.



12.1.3 - Time Zone

The menu allows configuration of time zone settings.

Figure 29. Time Zone

Time Zone

Time Zone: UTC-05:00 Eastern Time (US & Canada) ▼

Enable Daylight Saving

Start: March ▼ 2nd ▼ Sun ▼ 02:00 ▼

End : November ▼ 1st ▼ Sun ▼ 02:00 ▼

Save Cancel

Path – Settings, System, Time Zone

Parameters –

- **Time Zone** – Select the appropriate time zone from the drop-down.
- **Enable Daylight Saving** – Select to enable. DST start/end can change from year to year. Be sure to update this information.
 - **Start** – Select the month, date, day and time Daylight Saving Time starts from the dropdowns.
 - **End** – Select the month, date, day and time Daylight Saving Time ends from the dropdowns.

Configuration Instructions –

1. Click **Settings, System**.
2. Specify the time zone and DST settings.
3. Click **Save**, then click **Apply Changes** to enable the new settings.



12.2 - LAN Settings

The LAN Settings screen allows configuration of the access point LAN connection to the network router. In default mode, the IP Settings screen will show the DHCP IP address and default subnet mask. A static IP address, subnet mask, default gateway and DNS settings can be configured by disabling DHCP. LAN speed can also be configured in the Interface Settings menu.

Figure 30. LAN Settings

IP Settings	
IP Address	192.168.1.20
Subnet Mask	255.255.255.0
Default Gateway	192.168.1.1
Primary DNS	192.168.1.1
Secondary DNS	8.8.8.8
DHCP	<input type="checkbox"/> Enable

Interface Settings	
Speed	Auto
Duplex	Full

Path - Settings, LAN



12.2.1 - IP Settings

The IP Settings menu is used to configure access point IP address settings. In default mode, the IP Settings screen will show the DHCP IP address and default subnet mask.

Figure 31. IP Settings

IP Settings	
IP Address	192.168.1.20
Subnet Mask	255.255.255.0
Default Gateway	192.168.1.1
Primary DNS	192.168.1.1
Secondary DNS	8.8.8.8
DHCP	<input type="checkbox"/> Enable

 **Note** - By default, DHCP is enabled. DHCP is set to be disabled in this image to illustrate all the available options in the menu.

Path - Settings, LAN, IP Settings

Parameters -

 **Note** - DHCP is the default setting. If a static IP address has been assigned, but DHCP is selected, the assigned IP address and subnet mask will be grayed out. To confirm the WAP IP address, see: System Status screen/LAN Information/IP address.

- **IP Address** - Uncheck DHCP Enable to enter a static IP address for the AN-100/300. A static IP address is recommended.

 **Warning** - Be sure to use an IP address that is outside the DHCP server range to avoid duplicate addresses in the network.

- **Subnet Mask** - Enter the subnet mask for the AN-100/300.
Default: 255.255.255.0
- **Default Gateway** - With DHCP disabled, enter the default gateway for the access point (network router IP address).
- **Primary DNS** - With DHCP disabled, enter the primary DNS for the AN-100/300. This will typically be the network router IP address.
- **Secondary DNS** - With DHCP disabled, enter the secondary DNS for the AN-100/300. This will typically be the network router IP address.

 **Note** - Both primary and secondary addresses are required if a static IP address is assigned.

- **DHCP** - Allows the access point to receive a DHCP IP address from the network router if DHCP is enabled. **Un-check** the box to configure a static IP address (recommended).
Default: Enabled



Configuration Instructions -

1. Click **Settings, LAN**.
2. Specify the IP settings.
3. Click **Save**, then click **Apply Changes** to enable the new settings.

12.2.2 - Interface Settings

The Interface Settings menu is used to configure LAN speed and duplex settings.

Figure 32. Interface Settings

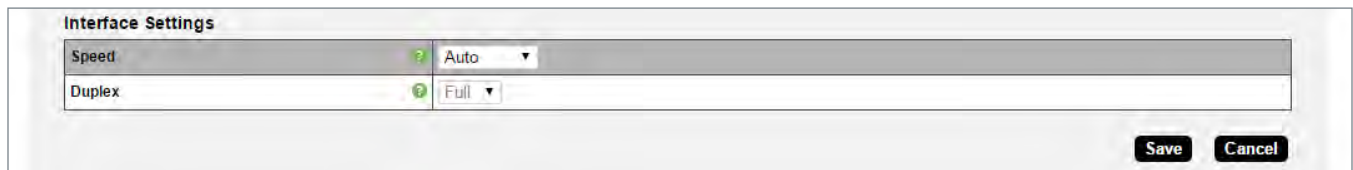

Path – Settings, LAN, Interface Settings

Parameters -

- **Speed** – Select LAN speed from Auto, 1Gbps (300 Series only), 100Mbps, 10Mbps, Disable (turns the LAN Port OFF)
Default: Auto
- **Duplex** – (10/100Mbps modes only) Select the duplex setting between the access point and the network router from Half or Full.
Default: Full

Configuration Instructions -

1. Click **Settings, LAN**.
2. Specify the interface settings.
3. Click **Save**, then click **Apply Changes** to enable the new settings.



12.3 - Wireless Settings

The Wireless Settings screen allows configuration of the access point's wireless settings and connections including 2.4GHz and 5GHz Radio settings, setup and configuration of wireless networks (SSID's) and all required wireless modes, channels, security settings and, guest network configuration.

Figure 33. Wireless Settings (AN-300-AP-I-N interface shown)

WIRELESS SETTINGS

Radio Settings

	2.4GHz	5GHz
Enable Interface	<input checked="" type="checkbox"/> Yes	<input checked="" type="checkbox"/> Yes
Operation Mode	Access Point	Access Point
Wireless Mode	802.11 B/G/N	802.11 A/N
Operating Channel	Auto	Auto
Channel Bandwidth	20 MHz	40 MHz
Extension Channel	Upper Channel	

Utilization of SSID

	2.4GHz	5GHz
SSID's Used	1	1
SSID's Available	7	7

Wireless Networks

Enable	Name (SSID)	Interface	Security Mode	Band Steering	Broadcast SSID	Client Isolation	Delete
<input checked="" type="checkbox"/> Yes	AN-100-AP-I-N_1	Both	WPA2-PSK	<input type="checkbox"/> Yes	<input checked="" type="checkbox"/> Yes	<input type="checkbox"/> Enable	

Guest Network

Enable	Name (SSID)	Interface	Security Mode	Broadcast SSID	Client Isolation
<input checked="" type="checkbox"/> Yes	Araknis-2.4_GuestNetwork	2.4GHz	Open	<input checked="" type="checkbox"/> Yes	<input checked="" type="checkbox"/> Enable
<input checked="" type="checkbox"/> Yes	Araknis-5.0_GuestNetwork	5GHz	Open	<input checked="" type="checkbox"/> Yes	<input checked="" type="checkbox"/> Enable

Manual IP Settings

Gateway IP Address: 192.168.200.1

Subnet Mask: 255.255.255.0

Automatic DHCP Server Settings

Starting IP Address: 192.168.200.100

Ending IP Address: 192.168.200.200

WINS Server IP: 0.0.0.0

Buttons: Apply Changes: 0, Add, Save, Cancel

Path - Settings, Wireless



12.3.1 - Radio Settings

The Radio Settings screen allows configuration of the access point's radio settings including wireless modes, operating channels, channel bandwidth, and extension channel.

Figure 34. Radio Settings

Radio Settings		
	2.4GHz	5GHz
Enable Interface	<input checked="" type="checkbox"/> Yes	<input checked="" type="checkbox"/> Yes
Operation Mode	Access Point ▼	Access Point ▼
Wireless Mode	802.11 B/G/N ▼	802.11 A/N ▼
Operating Channel	Auto ▼	Auto ▼
Channel Bandwidth	20 MHz ▼	40 MHz ▼
Extension Channel	Upper Channel ▼	

Path – Settings, Wireless, Radio Settings

Parameters –

Note – The AN-100 will indicate settings and information for the 2.4GHz channel. The AN-300 will indicate settings and information for the 2.4GHz and 5GHz channels.

- **Enable Interface** – Enable or disable the radio interface.
Default: Yes.
- **Wireless Mode** – Select the wireless mode for the radio. OPTIONS: 2.4GHz: 802.11b/g/n, 802.11b/g, 802.11b, 802.11g, 802.11n; 5GHz: 802.11a/n; 802.11a; 802.11n.
Default: 2.4GHz - 802.11b/g/n; 5GHz - 802.11a/n.
- **Operating Channel** – Select the desired Wi-Fi channel. Use a different channel than other APs on the network. On the 2.4GHz radio there are only three non-overlapping channels: 1, 6 and 11. Select a channel as far away from close-numbered channels as possible.
Default: Auto.

Pro Tip – In a multi-WAP environment, put adjacent WAPs on channels as far apart as possible. A spectrum analyzer tool (such as Metageek's Chanalyzer Pro) is recommended for ultimate insight into the network setup.

- **Channel Bandwidth** – Select 20/40MHz for auto select; Select 20MHz for better performance as needed; select 40MHz for greater speed as needed. This option is only available in 802.11n modes.
Default: 2.4GHz - 20MHz; 5GHz - 40MHz.
- **Extension Channel** – Only available when Wireless Mode is set to an 802.11n mode and channel Bandwidth is set to 20/40MHz or 40MHz. Extends the 20MHz channel to an Upper or Lower channel to achieve 40MHz bandwidth.
Default: 2.4GHz - Upper Channel; 5GHz - Lower Channel.

Pro Tip – The access point features a Site Survey tool that shows all 2.4GHz/5GHz networks and settings. Use the tool to scan the wireless neighborhood and find the channel with the least amount of interference and the extension channel with less traffic from other wireless devices.



Configuration Instructions -

1. Click **Settings, Wireless**.
2. Specify the radio settings.
3. Click **Save**, then click **Apply Changes** to enable the new settings.

12.3.2 - Utilization of SSID

Details the use and availability of SSID's configured in the WAP.

Figure 35. Utilization of SSID Status

Utilization of SSID		
	2.4GHz	5GHz
SSID's Used	1	1
SSID's Available	7	7

Path - Status, Wireless interface, Wireless Network

Parameters -



Note - The AN-100 will indicate settings and information for the 2.4GHz channel. The AN-300 will indicate settings and information for the 2.4GHz and 5GHz channels.

- **SSID's Used** - Number of SSID's currently in use by devices connected to the access point.
- **SSID's Available** - Number of SSID's

12.3.3 - Wireless Networks

The Wireless Networks menu allows configuration of access point wireless networks (SSID's), security settings, band steering and channel isolation.

Note - Be sure to change the SSID. The default settings are not secure.

Figure 36. Wireless Networks

Enable	Name (SSID)	Interface	Security Mode	Band Steering	Broadcast SSID	Client Isolation	Delete
<input checked="" type="checkbox"/> Yes	AN-100-AP-I-N_1	Both	WPA2-PSK	<input type="checkbox"/> Yes	<input checked="" type="checkbox"/> Yes	<input type="checkbox"/> Enable	

Add

Path - Settings, Wireless, Wireless Settings, Wireless Networks

Parameters -

Note - The AN-100 will indicate settings and information for the 2.4GHz channel. The AN-300 will indicate settings and information for the 2.4GHz and 5GHz channels.

- **Enable** - Select **Yes** to turn a wireless network ON.
Default: Yes (Checked)
- **Name (SSID)** - Enter the network name for the network being configured.
Default: araknis_initial; (Blank when adding a new network).

Note - Be sure to change the SSID. The default settings are not secure.

- **Interface** - Select 2.4GHz/5GHz or Both Channel Frequency.
Default: Both, (2.4GHz when adding a network).
- **Security Mode** - Configure the security mode for each wireless network. Select a security mode from the drop-down to open the Wireless Security Setup Window ("Figure 37. Wireless Security - WPA-PSK and WPA2-PSK Modes" on page 43).
- **Band Steering** - (AN-300-AP-I-N only) Band steering uses both signal quality and throughput relative to the client device to determine whether the client should communicate on the 2.4- or 5GHz band. This optimizes signal strength to the device.
Default: Disabled (Unchecked)
- **Broadcast SSID** - Select whether or not to publicly display the SSID to nearby Wi-Fi devices.
Default: Yes
- **Channel Isolation** - Select to prevent communication between wireless clients on different SSID's.
Default: Not selected.
- **Add** - Click to add a wireless network.
- **Delete** - Click to delete a wireless network.



12.3.4 - Wireless Security Menu

The Wireless Security menu opens during the setup of an existing or new wireless network.

12.3.4.1 - WPA-PSK Mixed and WPA2-PSK Modes

Figure 37. Wireless Security – WPA-PSK and WPA2-PSK Modes

Wireless Security	
Name (SSID)	"LAP2"
Security Mode	WPA2-PSK
Encryption	AES
Passphrase
Group Key Update Interval	3600

Save Cancel

Path – Settings, Wireless, Wireless Networks, Security Mode

Parameters –

- **Name (SSID)** – The name of the network being configured.
- **Security Mode** – Select a mode from the drop-down. Use the same mode as the network router and other APs on the network. Selecting a non-PSK mode will cause the menu options to change.
- **Encryption** – WPA2-PSK: AES; WPA2-PSK Mixed: Both (TKIP+AES).
- **Passphrase** – Enter the appropriate passphrase for the wireless network being configured. If using the ASCII format, the password must be 8-63 characters in length. If using HEX, the password must be 64 HEX characters in length.
Default: Blank
- **Group Key Update Interval** – Enter a value to specify how often in seconds the Group key changes. RANGE: 30-3600 seconds.
Default: 3600 (60 minutes)
- **Save** – Click to save changes to the Wireless Security Settings for this network. The window will close.
- **Cancel** – Click to cancel changes to the Wireless Security Settings for this network. The window will close.



12.3.4.2 - WPA and WPA2 Modes

Figure 38. Wireless Security – WPA-PSK and WPA2-PSK Modes

Wireless Security	
Name (SSID)	araknis_initial
Security Mode	WPA2
Encryption	AES
Group Key Update Interval	3600
Radius Server	
Radius Port	1812
Radius Secret	
Radius Accounting	Disable
Radius Accounting Server	
Radius Accounting Port	1813
Radius Accounting Secret	
Interim Accounting Interval	600

- **Name (SSID)** – The name of the network being configured.
- **Security Mode** – Select a mode from the drop-down. Use the same mode as the network router and other APs on the network. Selecting a PSK mode will cause the menu options to change.
- **Encryption** – Cannot be modified. WPA2: AES; WPA Mixed: Both (TKIP+AES).
- **Group Key Update Interval** – Enter how often the Group Key changes (from 30-3600 seconds).
Default: 3600 (60 minutes)
- **Radius Server** – Enter the Radius Server IP address.
Default: Blank
- **Radius Port** – Enter the Radius Server connection port number.
Default: 1812 (This is a dedicated TCP/UDP port and typically should not be changed.)
- **Radius Secret** – Enter the Radius Server connection secret.
Default: Blank
- **Radius Accounting** – Enable or disable Radius Accounting.
Default: Disable
- **Radius Accounting Server** – Enter the Radius Accounting Server IP address.
Default: Blank
- **Radius Accounting Port** – Enter the Radius Accounting Server connection port number.
Default: 1813 (This is a dedicated TCP/UDP port and typically should not be changed.)
- **Radius Accounting Secret** – Enter the Radius Accounting Server connection secret.
Default: Blank
- **Interim Accounting Interval** – Enter a value for how often accounting data will be sent, in seconds.
RANGE: 60-600 seconds.
Default: 600 (10 minutes)
- **Save** – Click to save changes. The window will close.
- **Cancel** – Click to cancel changes. The window will close.



12.3.5 - Guest Network

Use the Guest Network menu to configure guest networks. These optional networks are useful for allowing access to temporary users and controlling what parts of the network they can access.

Figure 39. Guest Network

Guest Network					
Enable	Name (SSID)	Interface	Security Mode	Broadcast SSID	Client Isolation
<input type="checkbox"/> Yes	Araknis-2.4_GuestNetwork	2.4GHz	Open	<input type="checkbox"/> Yes	<input checked="" type="checkbox"/> Enable
<input type="checkbox"/> Yes	Araknis-5.0_GuestNetwork	5GHz	Open	<input type="checkbox"/> Yes	<input checked="" type="checkbox"/> Enable
Manual IP Settings					
Gateway IP Address		192.168.200.1			
Subnet Mask		255.255.255.0			
Automatic DHCP Server Settings					
Starting IP Address		192.168.200.100			
Ending IP Address		192.168.200.200			
WINS Server IP		0.0.0.0			

Path – Settings, Wireless, Guest Network

Parameters –

Note – The AN-100 will indicate settings and information for the 2.4GHz channel. The AN-300 will indicate settings and information for the 2.4GHz and 5GHz channels.

- **Enable** – Select to create a guest network. This will allow guests to log in to the wireless system without having to compromise network security by giving guests the password to the home network. There are separate 2.4GHz and 5GHz Guest Networks. If the guest is using an 802.11b/g device, (2.4GHz) they will only need the password to the 2.4GHz Network. If the guest is using an 802.11a/n device (5GHz) they will need the password to the 5GHz Network, and if the guest is using a device that can connect on both 2.4GHz and 5GHz, (iOS devices) they should have both.
Default: Not Selected.
- **Name (SSID)** – Enter an SSID for the guest network.
Default: Araknis-2.4_GuestNetwork; Araknis-5.0_GuestNetwork
- **Edit** – Click the **Edit** button to open the Guest Network Security Setup Window.

Note – Guest networks are limited to Open, WPA-PSK Mixed and WPA2-PSK encryption modes. See section “12.3.4.1 - WPA-PSK Mixed and WPA2-PSK Modes” on page 43 for encryption setup instructions.

- **Security Mode** – This indicates the Security Mode and Encryption selected in the Edit Mode, previous.
Default: None
- **Broadcast SSID** – Selecting this option will allow the guest network SSID to appear in ‘Network Lists’ on wireless devices for user login. If not selected, the user will have to know the SSID and enter it manually to access the network.



Default: Un-selected.

- **Channel Isolation** – Select to prevent communication between wireless clients on different SSID's of the guest network.

Default: Selected.

- **Manual IP Settings** – Use the access point's defaults or manually enter IP address settings.

- **Gateway IP Address** – Enter the access point's Guest Network Gateway IP address.

Default: 192.168.200.1

- **Subnet Mask** – Enter the subnet mask for the access point's Guest Network Gateway.

Default: 255.255.255.0

- **Automatic DHCP Server Settings**

- **Starting IP Address** – Enter the lowest address available for the Guest Network.

Default: 192.168.200.100

- **Ending IP Address** – Enter the highest address available for the Guest Network.

Default: 192.168.200.200

- **WINS Server IP** – Enter the IP address for the WINS Server for the Guest Network.

Default: 0.0.0.0



12.4 - Security Settings

The Security Settings screen allows configuration of who can log into the access point interface and what level of privileges they have, how the device can be accessed, email notification of system status and warnings, and device discovery.

Figure 40. Security Settings

The screenshot displays the 'SECURITY SETTINGS' page. At the top, it shows system status: 'CLOUD SERVER: Connected', 'System Time: 2015-09-09 12:12:06', and 'System Uptime: 14d 19:58:45'. The left sidebar lists navigation options: STATUS (SYSTEM, WIRELESS INTERFACE), SETTINGS (SYSTEM, LAN, WIRELESS, SECURITY, SCHEDULE), MAINTENANCE (PING, TRACEROUTE, FILE MANAGEMENT, RESTART, LOG OUT), and ADVANCED. A button at the bottom of the sidebar says 'Apply Changes: 0'. The main content area is divided into four sections:

- User Accounts:** A table with columns: Select, Username, Privilege Level, Password, Confirm Password, and Delete. One user 'admin' is listed with 'admin' as the privilege level and masked passwords. 'Add' and 'Edit' buttons are present.
- Access Control:** A table with columns: Service, Status, and Value. Services include HTTP Port (80), Web Access (Enable), Telnet (Disable), and SSH (Disable).
- Email Alert:** A form with fields for Status (Enable checkbox), From, To, Subject, Email Account, Username, Password, SMTP Server (with a Port sub-field), and Security Mode (SSL/TLS dropdown). A 'Send Test Mail' button is at the bottom right.
- Device Discovery:** A table with columns: Service, Status, and Value. Services include Bonjour (Disable), UPnP (Disable), and Araknis EZ Access (Enable).

'Save' and 'Cancel' buttons are located at the bottom right of the page.

Path – Settings, Security



12.4.1 - User Accounts

The User Accounts menu allows configuration of who can log into the access point and what level of privileges they have.

Figure 41. User Accounts

Select	Username	Privilege Level	Password	Confirm Password	Delete
<input type="checkbox"/>	admin	admin	*****	*****	

Add **Edit**

Path – Settings, Security, User Accounts

Parameters –

- **Select** – Select to allow editing of the selected table entry.
Default: Not selected
- **Username** – Click the Edit button to access the settings on a selected User Account. Enter a new username for logging into the access point. Use letters, numbers, or punctuation. Limited to 32 characters, including spaces.
Default: araknis (Blank when adding a new account)
- **Privilege Level** – Indicates the level of device management for the logged in user. OPTIONS: admin, Status, Status+Settings.
Default: admin Status+Settings when adding a new account)
- **Password** – Enter a new login password. Use letters, numbers, or punctuation. Limited to 32 characters, including spaces.
Default: araknis (Blank when adding a new account)
- **Confirm Password** – Confirm a new login password (enter same password as above).
Default: araknis (Blank when adding a new account)
- **Delete** – Click the icon to delete a specific user account.
- **Add** – Click to add a new user account.
- **Edit** – Click the **Select** arrow in the left column of a user account and click **Edit** to modify the account.

Configuration Instructions –

1. Click **Settings, Security**.
2. Specify the user account settings.
3. Click **Save**, then click **Apply Changes** to enable the new settings.



12.4.2 - Access Control

The Access Control menu allows configuration of how the access point can be accessed.

Figure 42. Access Control

Access Control	
HTTP Port	80
Web Access	Enable
Telnet	Disable
SSH	Disable

Path – Settings, Security, Access Control

Parameters –

- **HTTP Port** – Enter device web server port to connect.

Default: 80

Pro Tip – Assign a unique port number to enable remote access to the access point web interface via port forwarding on the network router.

- **Web Access** – Select Enable or Disable to enable or disable the ability to modify the device via Web Browser.

Default: Enable

Caution – Disabling web access will cause a loss of connection to the web interface. If this occurs, regain connectivity by restoring the hardware to factory default settings. (Press Reset button for 10 seconds.)

- **Telnet** – Enable or Disable the ability to modify the device via a command line interface (CLI) through a telnet session.

Default: Enable

- **SSH** – Enable or Disable the ability to modify the device via a command line interface (CLI) with a secure channel.

Default: Disable

Configuration Instructions –

1. Click **Settings, Security**.
2. Specify the access control settings.
3. Click **Save**, then click **Apply Changes** to enable the new settings.



12.4.3 - Email Alert

The Email Alert menu allows configuration of the email notification system for status and warnings.

Figure 43. Email Alert Setup Example

Email Alert	
Status	<input type="checkbox"/> Enable
From	<input type="text"/>
To	<input type="text"/>
Subject	<input type="text"/>
Email Account	
Username	<input type="text"/>
Password	<input type="password"/>
SMTP Server	<input type="text"/>
	Port: <input type="text"/>
Security Mode	SSL/TLS ▼
<input type="button" value="Send Test Mail"/>	

Path - Settings, Security, Email Alerts

Parameters -

- **Status** - Select Enable to send email notifications in the event of certain abnormal conditions.
Default: Not selected
- **From** - Enter the email address of the sender.
Default: Blank
- **To** - Enter the email address of the recipient.
Default: Blank
- **Subject** - Information regarding the nature of the system condition.
Default: [Email-Alert][araknis][88:DC:96:1D:33:6B][Configuration Changed]
- **Email Account** -
 - **Username** - Enter the username for the email account (Outlook, Gmail, etc.) sending the alert.
Default: Blank
 - **Password** - Enter the password for the email account (Outlook, Gmail, etc.) sending the alert.
Default: Blank
 - **SMTP Server** - Enter the SMTP Server and Port Number of the email client sending emails.
Default: SMTP Server Blank; Port: 25
 - **Security Mode** - Select a security mode for sending Email Alerts. None, SSL/TLS, STARTTLS
Default: None
- **Send Test Email** - Click the button to send a test email to confirm Email Alert settings.



Figure 44. Common Email Client Ports

Email Client	Ports(TLS)	Ports(SSL)
Gmail	587	465
Outlook	25 or 587	-
Microsoft Exchange	25	465
Yahoo	-	465
Office 365	587	-

Configuration Instructions -

1. Click **Settings, Security**.
2. Specify the email alert settings.
3. Click **Save**, then click **Apply Changes** to enable the new settings.



12.4.4 - Device Discovery

The Device Discovery menu allows configuration of how or if the access point can search for and connect to network devices via Bonjour and UPnP.

Figure 45. Device Discovery

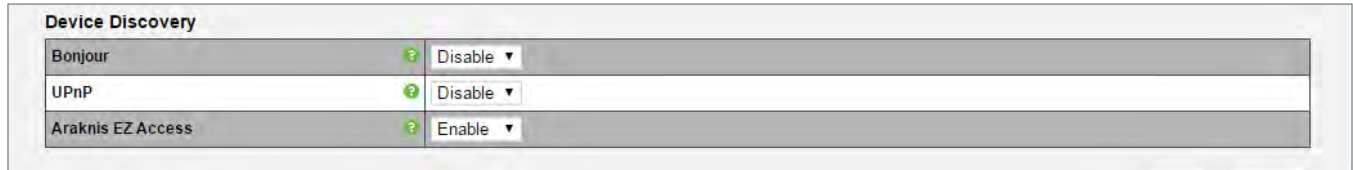

Path – Settings, Security, Device Discovery

Parameters –

- **Bonjour** – Enable to allow the access point to search for and connect to network devices running Apple iOS and OS X. Bonjour can also be run on devices running a Microsoft OS.
Default: Disable
- **UPnP** – Enable to allow the access point to search for and connect to network devices via UPnP Protocol (Universal Plug and Play).
Default: Disable
- **Araknis EZ Access** – Use a URL to access the web interface (see section “9.2 - Configured System Name Access” on page 16).
Default: Enable



Caution – If VLANs are enabled, this setting will automatically become disabled. In order for VLANs to work correctly, it must remain disabled and will require you to use the local IP address of the WAP in order to gain access to the GUI.

Configuration Instructions –

1. Click **Settings, Security**.
2. Specify the device discovery settings.
3. Click **Save**, then click **Apply Changes** to enable the new settings.



12.5 - Schedule

Use the schedule settings menu to configure automated features including auto reboot, auto ping, and Wi-Fi access schedules for different SSID's.

Figure 46. Schedule Settings Menu

SCHEDULE SETTINGS

CLOUD SERVER: Connected | System Time: 2015-09-09 12:21:01 | System Uptime: 14d 20:07:40

Auto Reboot Settings

Status: Enable Disable
NOTE: Please assure that the Time Zone Settings is synced with your local time when enabling the Auto Reboot Settings.

Date: Every: Sunday Monday Tuesday Wednesday Thursday Friday Saturday

Time: 0 : 0 (24-Hour)

Auto Ping Gateway Settings

Status: Enable Disable
NOTE: Please assure that the Time Zone Settings is synced with your local time when enabling the Auto Ping Gateway Settings.

Gateway IP Address: **Get Current Gateway IP**

Timeout Before Reboot: 30 second(s) (10..60)

Continuous Ping Timeouts: 10 time-outs (3..10)

Ping Delay After Auto Reboot: 15 minute(s) (5..30)

Reboot Attempts: 5 reboots (0..10, 0=Infinite reboots)

Wi-Fi Scheduler

Status: Enable Disable
NOTE: Please assure that the Time Zone Settings is synced with your local time when enabling the Wi-Fi Scheduler.

Wireless Radio: 2.4GHz

SSID Selection: AN-100-AP-I-N_1

Schedule Templates: Choose a template

Day	Availability	Duration
Sunday	available	00 : 00 ~ 24 : 00
Monday	available	00 : 00 ~ 24 : 00
Tuesday	available	00 : 00 ~ 24 : 00
Wednesday	available	00 : 00 ~ 24 : 00
Thursday	available	00 : 00 ~ 24 : 00
Friday	available	00 : 00 ~ 24 : 00
Saturday	available	00 : 00 ~ 24 : 00

Apply Changes: 0 | **Save** | **Cancel**

Path – Settings, Schedule



12.5.1 - Auto Reboot Settings

The WAP can be set to reboot at specified times on a daily or weekly schedule. Rebooting the WAP will help ensure the best network performance by keeping the system memory clear and ending unnecessary connections.

Figure 47. Auto Reboot Settings

Auto Reboot Settings	
Status	<input type="radio"/> Enable <input checked="" type="radio"/> Disable <small>NOTE: Please assure that the Time Zone Settings is synced with your local time when enabling the Auto Reboot Settings.</small>
Date	Every: <input type="checkbox"/> Sunday <input type="checkbox"/> Monday <input type="checkbox"/> Tuesday <input type="checkbox"/> Wednesday <input type="checkbox"/> Thursday <input type="checkbox"/> Friday <input type="checkbox"/> Saturday
Time	0 : 0 (24-Hour)

Path – Settings, Schedule, Auto Reboot Settings

Parameters –

- **Status** – Enable or Disable Auto Reboot.
Default: Disable
- **Date** – Check the boxes for the WAP should reboot on.
- **Time** – Enter the time for the reboot to take place in 24 hour format. (00:00=midnight; subtract 12 hours from 24 hour time for standard time 17:00-12:00=5:00pm)

Configuration Instructions –

1. Click **Settings, Schedule**.
2. Enable Auto Reboot.
3. Set the desired days and time for reboots to occur.
4. Click **Save**, then click **Apply Changes** to enable the new settings.



12.5.2 - Auto Ping Gateway Settings

Use auto ping to help ensure the WAP maintains network connectivity. Configure the WAP to ping the gateway, and if the ping results fall outside the desired settings, reboot the system

Figure 48. Auto Reboot Settings

Auto Ping Gateway Settings	
Status	<input type="radio"/> Enable <input type="radio"/> Disable <small>NOTE: Please assure that the Time Zone Settings is synced with your local time when enabling the Auto Ping Gateway Settings.</small>
Gateway IP Address	<input type="text"/> Get Current Gateway IP
Timeout Before Reboot	<input type="text" value="30"/> second(s) (10..60)
Continuous Ping Timeouts	<input type="text" value="10"/> time-outs (3..10)
Ping Delay After Auto Reboot	<input type="text" value="15"/> minute(s) (5..30)
Reboot Attempts	<input type="text" value="5"/> reboots (0..10, 0=Infinite reboots)

Path - Settings, Schedule, Auto Reboot Settings

Parameters -

- **Status** - Enable or Disable Auto Reboot.
Default: Disable
- **Date** - Check the boxes for the WAP should reboot on.
- **Time** - Enter the time for the reboot to take place in 24 hour format. (00:00=midnight; subtract 12 hours from 24 hour time for standard time 17:00-12:00=5:00pm)



Pro Tip - Set the WAP to reboot when there are few or no users connected. This will ensure that users have the best experience when connected to the WAP.

Configuration Instructions -

1. Enable Auto Reboot.
2. Set the desired days and time for reboots to occur.
3. Click **Save**, then click **Apply Changes** to enable the new settings.



12.5.3 - Wi-Fi Scheduler

The Wi-Fi Scheduler is used to configure when wireless networks are available for use. The scheduler is based on a 24-hour clock (00:00 = 12:00AM, the start of a given day).

Figure 49. Wi-Fi Scheduler

Day	Availability	Duration
Sunday	available	00 : 00 - 24 : 00
Monday	available	00 : 00 - 24 : 00
Tuesday	available	00 : 00 - 24 : 00
Wednesday	available	00 : 00 - 24 : 00
Thursday	available	00 : 00 - 24 : 00
Friday	available	00 : 00 - 24 : 00
Saturday	available	00 : 00 - 24 : 00

Path – Settings, System, Wi-Fi Scheduler

Parameters –



Note – The AN-100 will indicate settings and information for the 2.4GHz channel. The AN-300 will indicate settings and information for the 2.4GHz and 5GHz channels.

- **Status** – Enable or Disable the Wi-Fi Scheduler.
Default: Disable
- **Wireless Radio** – Select 2.4GHz or 5GHz for the channel frequency to be scheduled.
Default: 2.4GHz.
- **SSID Selection** – Select the SSID to be scheduled.
- **Schedule Templates** – Create different Wi-Fi schedules using templates as detailed below:
 - **Choose a Template** – Select the template that matches the schedule requirements.
 - **Always Available** – 00:00-24:00. The wireless network is always ON.
 - **Available 8-17 Daily** – 08:00-17:00. The wireless network is ON at 8:00AM and OFF at 5:00PM.
 - **Available 8-17 Daily Except Weekends** – 08:00-17:00. The wireless network is ON at 8:00AM and OFF at 5:00PM Monday-Friday and always OFF on Saturday and Sunday.
 - **Custom Schedule** – Allows custom configuration of the wireless network ON/OFF schedule based upon user requirements.
 - **Schedule Table** – Modify template schedules or make custom schedules. See the configuration instructions for setup.
 - **Day** – Day of the week being configured.
 - **Availability** – Select whether the device is **Available** for the set duration, or **Unavailable** for the specified day.
 - **Duration** – Time setting from start to finish for availability in 24 hour format. 00:00=midnight; subtract 12 hours from 24 hour time for standard time 17:00-12:00=5:00pm;)

Configuration Instructions -

Application example: The 2.4GHz SSID, “Market 2”, needs to be made available during the hours of 8AM to 6PM Monday through Friday, 10AM to 5PM on Saturdays, and unavailable the rest of the week.

Figure 50. Wi-Fi Scheduler Menu

Wi-Fi Scheduler			
Status	<input checked="" type="radio"/> Enable <input type="radio"/> Disable <small>NOTE: Please assure that the Time Zone settings is correct with your local time when enabling the WPA Scheduler.</small>		
Wireless Radio	2.4GHz ▾		
SSID Selection	Market 2 ▾		
Schedule Templates	Available 8-17 daily ▾		
Schedule Table	Day	Availability	Duration
	Sunday	available ▾	08 :00 ~ 17 :00
	Monday	available ▾	08 :00 ~ 17 :00
	Tuesday	available ▾	08 :00 ~ 17 :00
	Wednesday	available ▾	08 :00 ~ 17 :00
	Thursday	available ▾	08 :00 ~ 17 :00
	Friday	available ▾	08 :00 ~ 17 :00
	Saturday	available ▾	08 :00 ~ 17 :00

1. Enable the Wi-Fi Scheduler feature.
2. Select the wireless frequency and SSID for scheduling. *In our example, we will select 2.4GHz frequency, and the SSID, Market 2.*
3. Select an option from the Schedule Templates dropdown to use. *In our example, we will select Available 8-17 Daily, since this template is closest to the schedule needed.*
4. Change the Schedule Table to work on the desired schedule. *In our example, we will make the following changes:*
 - Sunday: Set to **Unavailable** so that no access is available the entire day.
 - Monday-Friday: Set to **Available** and enter a duration of **08:00 - 18:00** (8AM-6PM)
 - Saturday: Set to **Available** and enter a duration of **10:00 - 17:00** (10AM-5PM)
5. Click **Save** at the bottom of the System Information screen. Click **Apply Changes** to enable the new schedule. The figure below shows the configured and applied settings.

Figure 51. Wi-Fi Scheduler Setup Complete

Wi-Fi Scheduler			
Status	<input checked="" type="radio"/> Enable <input type="radio"/> Disable <small>NOTE: Please assure that the Time Zone settings is correct with your local time when enabling the WPA Scheduler.</small>		
Wireless Radio	2.4GHz ▾		
SSID Selection	Market 2 ▾		
Schedule Templates	Available 8-17 daily ▾		
Schedule Table	Day	Availability	Duration
	Sunday	unavailable ▾	08 :00 ~ 18 :00
	Monday	available ▾	08 :00 ~ 18 :00
	Tuesday	available ▾	08 :00 ~ 18 :00
	Wednesday	available ▾	08 :00 ~ 18 :00
	Thursday	available ▾	08 :00 ~ 18 :00
	Friday	available ▾	08 :00 ~ 18 :00
	Saturday	available ▾	10 :00 ~ 17 :00



13 - Maintenance

13.1 - Ping Test

The Ping Test screen can be used to determine if a particular IP address can be reached across an IP network.

Figure 52. Ping Test

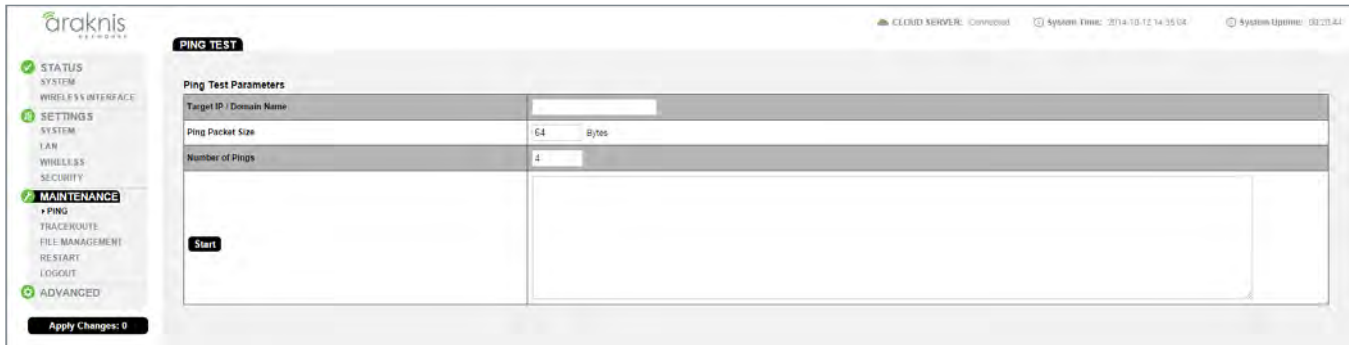

Path – Maintenance, Ping

Parameters –

- **Target IP / Domain Name** – Enter the IP address of a device or web page to determine if it can be reached.
- **Ping Packet Size** – Enter the packet size of each ping. Maximum size: 65535.
Default: 64 Bytes
- **Number of Pings** – Enter the number of ping attempts.
Default: 4
- **Start** – Click the Start button to send the Ping. Ping Test results will be displayed in the text frame. Ideal results: Same number of packets transmitted/received, 0% packet loss.

Configuration Instructions –

1. Click **Maintenance, Ping**.
2. Specify the ping test settings.
3. Click **Start**.



13.2 - Traceroute Test

The Traceroute Test screen can be used to display the route and delays for data packets to/from a destination on an IP network.

Figure 53. Traceroute Test



Path – Maintenance, Traceroute

Parameters –

- **Target IP / Domain Name** – Enter the IP address of a device or web page to show the path of communication to that device or website.
- **Start** – Click the Start button to start Traceroute. Traceroute Test results will be displayed in the text frame.
- **Stop** – Click the Stop button to stop Traceroute.

Configuration Instructions –

1. Click **Maintenance, Traceroute**.
2. Specify the traceroute test settings.
3. Click **Start**.
4. Click **Stop** to end the test.



13.3 - File Management

Use the File Management screen to back up or restore settings and apply firmware updates.

Figure 54. File Management

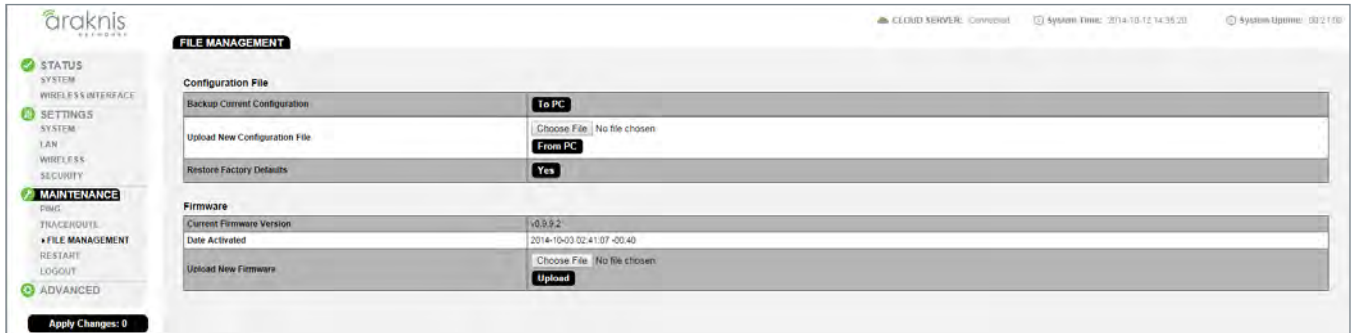

Path – Maintenance, File Management

13.3.1 - Configuration File

Use the Configuration File menu to back up or restore settings to the access point.

Figure 55. Configuration File

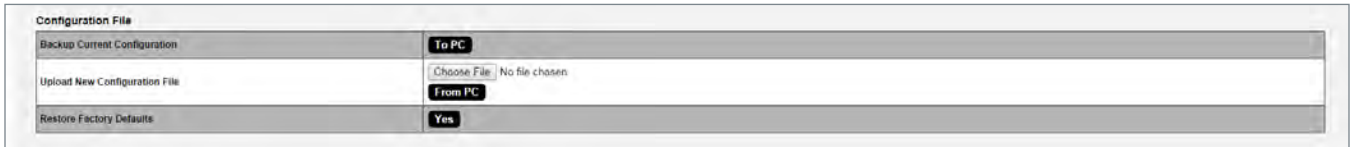

Path – Maintenance, File Management, Configuration File

13.3.1.1 - Backup Current Configuration

Save the access point’s current configuration settings to a “.tar” format compressed archive on your computer.

1. Click the To PC button and select a location to save the file.
2. Name the file and save it to your computer.

13.3.1.2 - Upload New Configuration File

Restore previously saved configuration settings to the access point to restore settings.

1. Click the Choose File button and select a configuration file (“.tar” file type) from the Open window.
2. The file name will appear to the right of the Choose File button as shown in Figure 56. Uploading a New Configuration File, below.
3. Click the From PC button to upload the configuration file. Wait while the Rebooting screen opens and loads the selected configuration. When the upload is finished, the Authentication Required (Log In) window will open.
4. Log in and confirm Configuration settings.

Figure 56. Uploading a New Configuration File

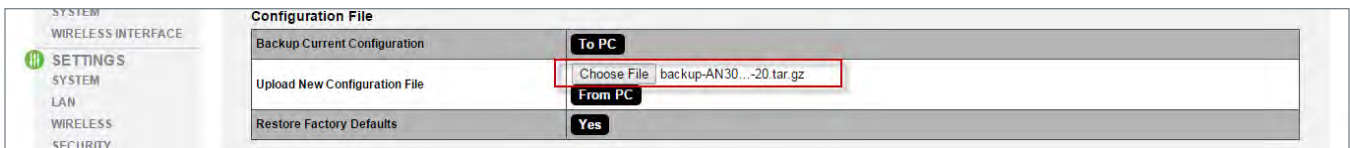



13.3.1.3 - Restore Factory Defaults

Use the File Management screen to restore default settings.

Note - When restoring factory defaults, the SSID, IP address, subnet mask, and gateway IP address will also be reset. Reconnect to the access point using the instructions beginning in section “9.1 - EZ Access Method (Default)” on page 15.

Figure 57. Restore Factory Defaults

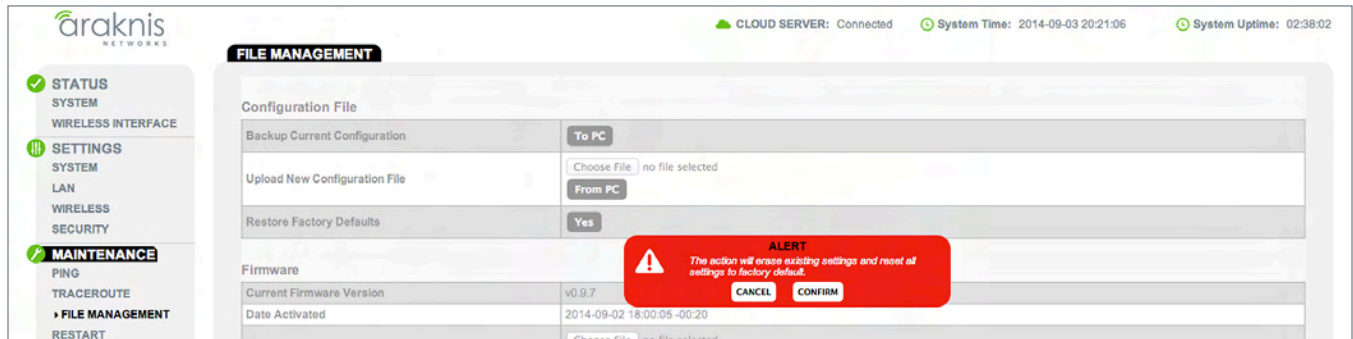

Path - Maintenance, File Management, Configuration File, Restore Factory Defaults

Note - All current settings will be permanently lost if not backed up. See Backup Current Configuration, above, to backup current settings prior to executing Restore to Factory Defaults.

Configuration Instructions -

1. Click the **Yes** button to restore the access point to factory default settings. The red ALERT message will appear.
2. Click **Confirm** to restore factory defaults. Wait while the rebooting screen is open and loading the selected configuration. When the configuration upload is finished, the login window will appear.
3. Enter the username and password. (*araknis; araknis*)
4. Confirm the new configuration settings.

13.3.1.4 - Hardware Factory Default

If restoring factory defaults does not restore proper functionality to the AN-100/300, a hardware reset may be performed to reload the original base configuration file (saved in the access point’s memory).

Configuration Instructions -

1. Using a paper clip or other small, blunt tool press the reset button located on the top of the access point for 30 seconds.
2. After two to four minutes, the WAP will reboot. Restart the setup process or upload a previously saved configuration.



13.3.1.5 - Firmware

Use the Firmware menu to upload new firmware to the AN-100/300.

Figure 58. Firmware



Path – Maintenance, File Management, Firmware

Parameters –

- **Current Firmware Version** – Indicates the current running firmware version.
- **Date Activated** – Date the current firmware was uploaded and activated.

Configuration Instructions –

1. Click the **Browse** button to navigate to where the firmware file is saved.
2. Select the file and then press Enter/Return on the computer keyboard or click **Open** on the Upload menu. (The firmware file name should appear next to the Upload New Firmware File **Browse** button.)
3. Click **Upload**. The Upload Firmware Information screen will open.
4. Click **Upgrade**. Wait while the new firmware loads. When the configuration upload is finished, the login screen will appear.
5. Enter the username and password.
6. Confirm the firmware version.



13.4 - Restart

Reboot the access point.

Figure 59. Restart

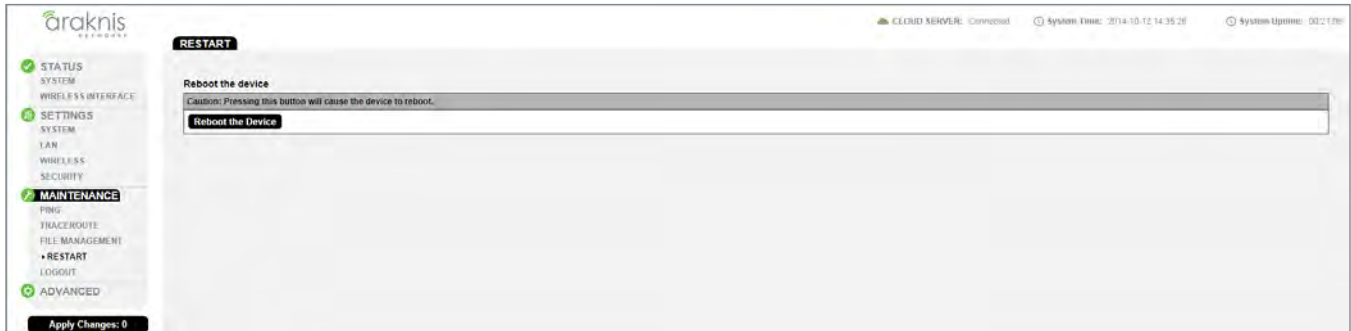

Path – Maintenance, Restart

Configuration Instructions –

1. Click the **Reboot the Device** button. The message, “This will reboot the device and may take a few seconds...” will appear.
2. Click **OK** to reboot (or **Cancel** to return to the Restart Screen).
3. Wait while the access point reboots. When the device has rebooted, the login screen will appear.
4. Enter the username and password.
5. Confirm the firmware and configuration.



13.5 - Logout

Logout can be used to change the user currently logged into setup. After working in the setup screens, a logged in user can simply close the browser tab or click Logout. Closing the browser tab will close the setup screen completely, Logout will end the session for the logged in user and open the Authentication Required (Log In) window.

Figure 60. Logout Alert

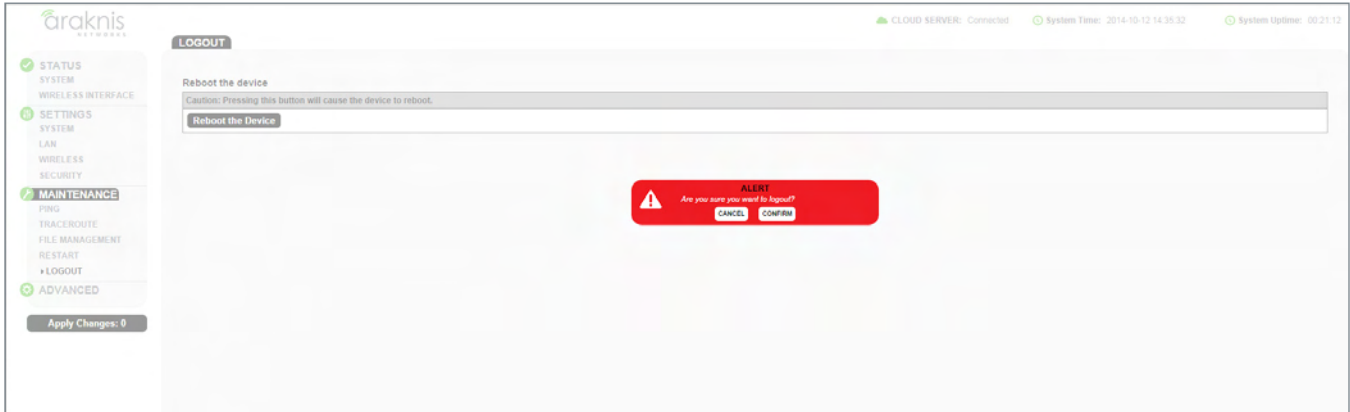

Path – Maintenance, Logout

Configuration Instructions –

1. From any screen, click **Logout** in the system menu. The Logout ALERT will appear on screen.
2. Click **Cancel** to return to the setup screen; click **Confirm** to log the current user out.



14 - Advanced Menu



Note - Advanced menu settings should not require any changes for most applications.

14.1 - Advanced Wireless Settings

The Advanced Wireless Settings screen allows configuration of radio settings for unit of measure, data rate, power and RTS/CTS Threshold as well as a client limit by band, (2.4GHz/5GHz).

Figure 61. Advanced Wireless Settings

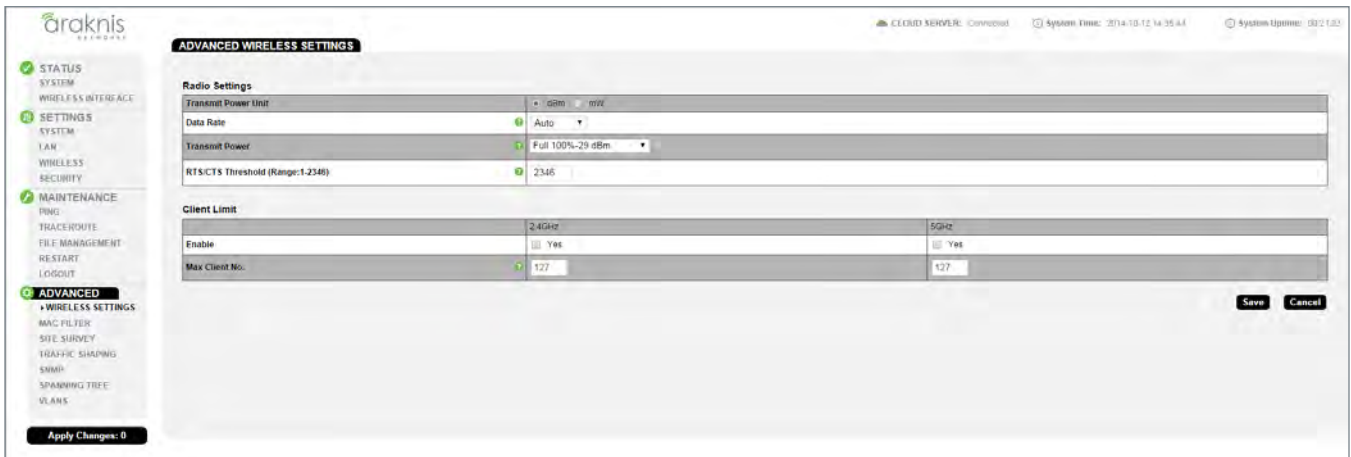

Path - Advanced, Wireless Settings



14.1.1 - Radio Settings

The Advanced Wireless Settings menu allows configuration of radio settings for unit of measure, data rate, power and RTS/CTS Threshold.

Figure 62. Radio Settings

Radio Settings	
Transmit Power Unit	• dBm • mW
Data Rate	Auto
Transmit Power	Full 100%-29 dBm
RTS/CTS Threshold (Range:1-2346)	2346

Path – Advanced, Wireless Settings, Radio Settings

Parameters –

- **Transmit Power Unit** – Select the preferred unit of measure. OPTIONS: dBm, mW.
Default: dBm.
- **Data Rate** – Select a setting from the drop-down to set the available transmit data rate permitted for connected clients. A lower data rate reduces throughput, but increases the transmission range. OPTIONS: See drop-down list.
Default: Auto.
- **Transmit Power** – Select a setting from the drop-down to set the radio power. A higher gain will improve performance but can also cause interference with other access points in close range on the same channel. Also, a higher coverage range corresponds with lower throughput (i.e. to achieve the highest transmit power, the connection must run at the lowest data rate). Set this value as low as possible (for adequate coverage) to get the maximum wireless speed/data throughput. OPTIONS: See drop-down list.
Default: Full 100% -29dBm.
- **RTS/CTS Threshold (Range: 1-2346)** – Enter a value for the threshold package size for RTS/CTS (request to send/clear to send). A lower number increases the frequency that the packets are sent and consumes more bandwidth. RANGE: 1-2346.
Default: 2346

Configuration Instructions –

1. Click **Advanced, Wireless Settings**.
2. Specify the radio settings.
3. Click **Save**, then click **Apply Changes** to enable the new settings.

14.1.2 - Client Limit

The Advanced Wireless Settings screen allows configuration of client limit by band, (2.4GHz/5GHz).

Figure 63. Client Limit Settings



Client Limit	2.4GHz	5GHz
Enable	<input type="radio"/> Yes	<input type="radio"/> Yes
Max Client No.	127	127

Path – Advanced, Wireless Settings, Client Limit

Parameters –

Note – The AN-100 will indicate settings and information for the 2.4GHz channel. The AN-300 will indicate settings and information for the 2.4GHz and 5GHz channels.

- **Enable** – Select to enable Client Limit, by channel.
Default: Not Selected.
- **Max Client No.** – Set the maximum number of clients that can be connected to a channel at a given time. (For AN-300, the maximum number of clients is for each radio interface.) RANGE: 1-127.
Default: 127.

Pro Tip – It is recommended to design the wireless network so that each access point can handle 30 clients at a given time.

Configuration Instructions –

1. Click **Advanced, Wireless Settings**.
2. Specify the client limit settings.
3. Click **Save**, then click **Apply Changes** to enable the new settings.



14.2 - Wireless MAC Filter Settings

The Wireless MAC Filter determines if wireless clients (computers, tablets, smartphones) can access the wireless network as defined by client MAC address. Authorized clients can be configured and viewed in the MAC Filter List.

Figure 64. Wireless MAC Filter Settings

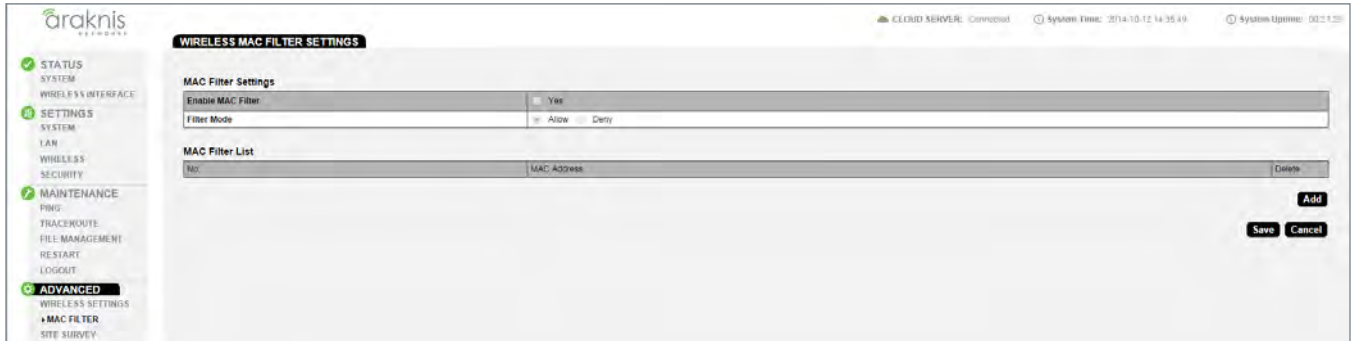

Path – Advanced, MAC Filter

14.2.1 - MAC Filter Settings

The MAC Filter Settings screen enables/disables Wireless MAC Filtering.

Figure 65. MAC Filter Settings

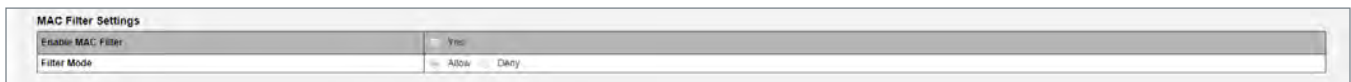

Path – Advanced, MAC Filter, MAC Filter Settings

Parameters –

- **Enable MAC Filter** – Select Yes to enable MAC Filtering.
Default: Not Selected.
- **Filter Mode** – Select Allow to permit wireless clients access to the wireless network as defined by wireless client MAC address. Select Deny to prevent wireless clients from accessing the wireless network as defined by wireless client MAC address. OPTIONS: Allow, Deny.
Default: Allow.

Configuration Instructions –

1. Click **Advanced, MAC Filter**.
2. Specify the wireless MAC filter settings.
3. Click **Save**, then click **Apply Changes** to enable the new settings.



14.2.2 - MAC Filter List

The Wireless MAC Filter List screen can be used to add/delete wireless clients to be filtered by MAC address.

Figure 66. MAC Filter List

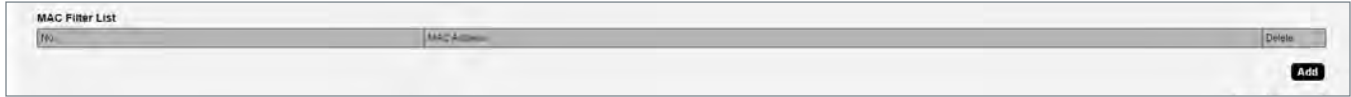

Path – Advanced, MAC Filter, MAC Filter List

Parameters –

- **No.** – The client number for a device being filtered by MAC address.
Default: Not available if MAC Filtering is disabled; client number is in the list if MAC Filtering is enabled.
- **MAC address** – The MAC address of a client being filtered by MAC address, if MAC address filtering is enabled.
Default: Blank.
- **Add** – Click to add a new client to be filtered by MAC address.
- **Delete** – Click to delete an existing client.

Configuration Instructions –

1. Click **Advanced, MAC Filter**.
2. Specify the MAC filter settings.
3. Click **Save**, then click **Apply Changes** to enable the new settings.



14.3 - WPS Settings

WPS (Wi-Fi Protected Setup) allows setup of WPS-equipped Wi-Fi devices...

Figure 67. WPS Settings Menu

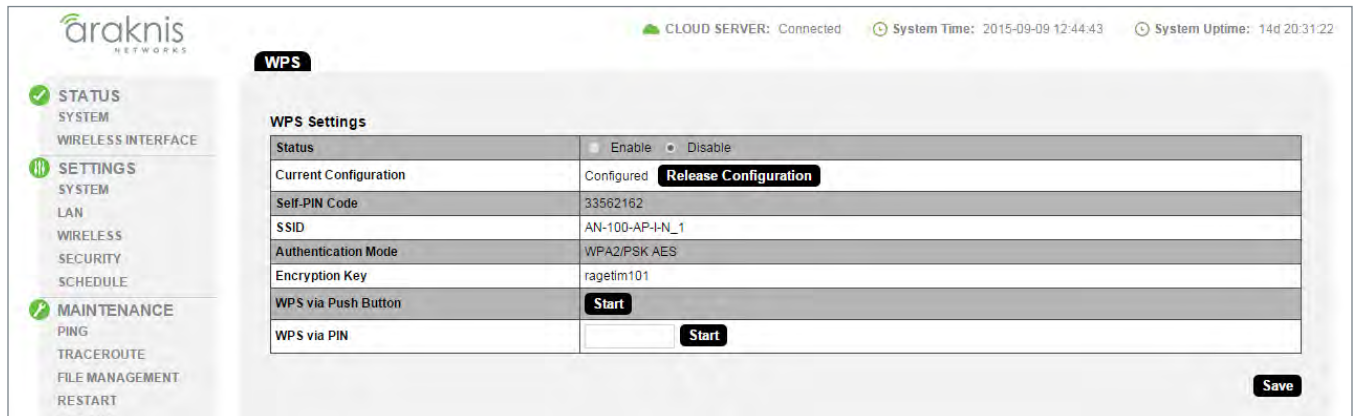

Path – Advanced, WPS

Parameters –

- **Status** – Enable or disable WPS.
Default: Disabled
- **Current Configuration** – Lists whether the WPS feature is configured or unconfigured.
 - **Release Configuration** – Press to release the current configuration settings. All devices connected using the configuration will lose Wi-Fi access.
- **Self-PIN Code**– The
Default: Blank.
- **SSID** – The
Default: Blank.
- **Authentication Mode** – The
Default: Blank.
- **Encryption Key** – The
Default: Blank.
- **WPS via Push Button** – The
Default: Blank.
- **WPS via PIN** – The
Default: Blank.

14.3.1 - Configuring WPS Connections

...

14.4 - Site Survey

The access point provides a convenient on-board Wi-Fi detection tool commonly known as a Wi-Fi sniffer that can be used to detect the presence of other 2.4GHz and 5GHz wireless networks. Parameters such as their modes, channels, security settings, signal strengths, encryptions, and types can be identified. Having this information can be useful during setup to avoid conflicts with other networks in the wireless neighborhood.

Figure 68. Site Survey Settings



Path – Advanced, Site Survey

14.4.1 - Select Interface

The Site Survey Select Interface screen can be used to select the frequency (2.4GHz/5GHz) to be scanned.

Figure 69. Site Survey Settings - Select Interface

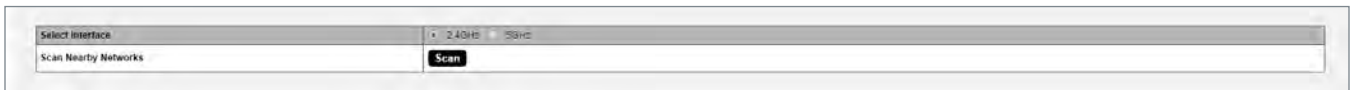

Path – Advanced, Site Survey, Select Interface

Parameters –

Note – The AN-100 will indicate settings and information for the 2.4GHz channel. The AN-300 will indicate settings and information for the 2.4GHz and 5GHz channels.

- **Select Interface** – Select whether to scan for 2.4GHz or 5GHz networks.
- **Scan Nearby Networks** – Click the Scan button to begin a scan.

Configuration Instructions –

1. Click **Advanced, Site Survey**.
2. Specify the site survey settings.
3. Click **Scan**.



14.4.2 - Result

The Site Survey Result shows detected 2.4GHz/5GHz wireless networks, their modes, channels, security settings, signal strengths, encryptions, and type based upon the frequency selected for scanning.

Figure 70. Site Survey Settings - shown with scan results

Result						
BSSID	SSID	Mode	Channel	Signal	Encryption	Type

Path – Advanced, Site Survey, Result

Parameters –

- **BSSID** – Basic Service Set Identification. Indicates the MAC address of a detected 2.4GHz or 5GHz neighboring access point.
- **SSID** – Service Set Identifier. Indicates the network name of a wireless network that a specific device is connected to.
- **Mode** – Indicates how a device is being used i.e. AP, bridge, etc.
- **Channel** – Indicates the channel a specific device is transmitting on.
- **Signal** – RSSI or Received Signal Strength Indicator. Indicates the signal strength of a detected network as received by the AN-100/300.
- **Encryption** – Indicates the security mode encryption of a detected device.
- **Type** – Indicates the wireless mode of the detected device.



14.5 - Spectrum Analyzer

...

Figure 71. Spectrum Analyzer Menu

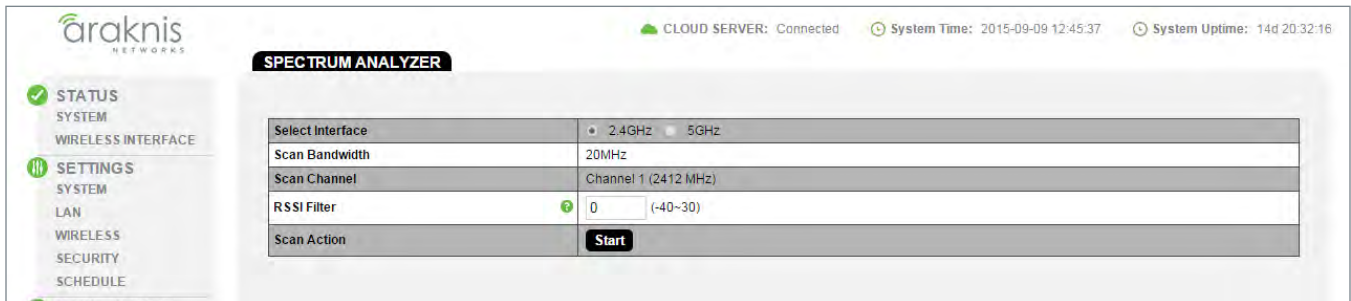

Path - Advanced, Site Survey, Result

Parameters -

- Select Interface - 2.4 or 5 Ghz antenna.
- Scan Bandwidth -
- Scan Channel -
- RSSI Filter -
- Scan Action -



14.6 - Wireless Traffic Shaping Settings

Traffic shaping is used to regulate packet flow to control wireless network saturation and improve (reduce) latency.

Figure 72. Wireless Traffic Shaping Settings

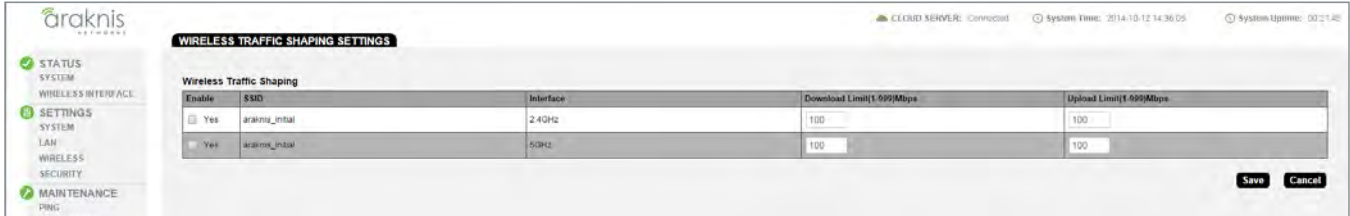

Path – Advanced, Traffic Shaping

Parameters –

Note – The AN-100 will indicate settings and information for the 2.4GHz channel. The AN-300 will indicate settings and information for the 2.4GHz and 5GHz channels.

- **Enable** – Select to enable Traffic Shaping on the 2.4GHz and/or 5GHz band.
- **SSID** – Indicates the network to which Traffic Shaping will be applied.
- **Interface** – Indicates 2.4GHz or 5GHz band.
- **Download Limit** – Enter a value to regulate download speed. RANGE: 1-999Mbps.
Default: 100Mbps.
- **Upload Limit** – Enter a value to regulate upload speed. RANGE: 1-999Mbps.
Default: 100Mbps.

Configuration Instructions –

1. Click **Advanced**, **Traffic Shaping**.
2. Specify the wireless traffic shaping settings.
3. Click **Save**, then click **Apply Changes** to enable the new settings.

14.7 - SNMP Settings

Simple Network Management Protocol (SNMP) is an IP network protocol that can be used to monitor network devices, audit network usage, detect network faults or inappropriate access, and, in some cases, configure remote devices.

Figure 73. SNMP Settings

The screenshot displays the 'SNMP SETTINGS' configuration page. On the left, a sidebar menu lists various system settings, with 'ADVANCED' selected and 'SNMP' highlighted. The main panel is divided into two sections:

- SNMPv2 Settings:**
 - Status: Enable/Disable
 - Contact: [Text Field]
 - Location: [Text Field]
 - Port: 161
 - Community Name (Read Only): public
 - Community Name (Read Write): private
 - Trap Destination Port: 162
 - IP Address: [Text Field]
 - Community Name: public
- SNMPv3 Settings:**
 - Status: Enable/Disable
 - Username: admin (1-31 Characters)
 - Authorized Protocol: MDS
 - Authorized Key: 12345678 (19-32 Characters)
 - Privacy Protocol: DES
 - Privacy Key: 12345678 (18-32 Characters)
 - Engine ID: [Text Field]

'Save' and 'Cancel' buttons are located at the bottom right of the configuration area.

Path – Advanced, SNMP

14.7.1 - SNMPv2 Settings

This screen allows configuration of SNMPv2 Settings.

Figure 74. SNMP Settings

SNMPv2 Settings	
Status	• Enable • Disable
Contact	<input type="text"/>
Location	<input type="text"/>
Port	161
Community Name (Read Only)	public
Community Name (Read Write)	private
Trap Destination	
Port	162
IP Address	<input type="text"/>
Community Name	public

Path – Advanced, SNMP, SNMPv2

Parameters –

- **Status** – Select Enable to enable SNMPv2. Select Disable to disable SNMPv2.
Default: Enable
- **Contact** – Enter the name of the person managing the SNMPv2 server.
Default: Blank
- **Location** – Enter the physical location of the SNMPv2 server.
Default: Blank
- **Port** – Indicates the port number for SNMPv2 ‘listening’.
Default: 161 (This is a dedicated TCP/UDP port and typically should not be changed.)
- **Community Name (Read Only)** – Indicates the password for SNMPv2 read only access.
Default: Public. ‘Public’ is a typical default of SNMP v2 devices for Read Only.
- **Community Name (Read Write)** – Indicates the password for SNMPv2 read/write access.
Default: Private.
- **Trap Destination** – An SNMPv2 Trap is a notification of a network event such as a fault or security event. The Trap Destination is typically the IP address of the SNMP server where trap messages will be sent.
 - **Port** – Indicates the SNMPv2 port number for ‘receiving traps’.
Default: 162 (This is a dedicated TCP/UDP port and typically should not be changed.)
 - **IP Address** – IP address of the SNMPv2 server that will receive SNMP traps.
 - **Community Name** – Indicates the password for the SNMPv2 trap community.

Configuration Instructions –

1. Click **Advanced, SNMP**.
2. Specify the SNMPv2 settings.
3. Click **Save**, then click **Apply Changes** to enable the new settings.

14.7.2 - SNMPv3 Settings

This screen allows configuration of SNMPv3 Settings.

Figure 75. SNMP Settings

SNMPv3 Settings	
Status	<input checked="" type="radio"/> Enable <input type="radio"/> Disable
Username	<input type="text" value="admin"/> (1-31 Characters)
Authorized Protocol	MD5 ▾
Authorized Key	<input type="text" value="12345678"/> (8-32 Characters)
Privacy Protocol	DES ▾
Privacy Key	<input type="text" value="12345678"/> (8-32 Characters)
Engine ID	<input type="text"/>

Path – Advanced, SNMP, SNMPv3

Parameters –

- Status** – Select Enable to enable SNMPv3. Select Disable to disable SNMPv3.
Default: Enable
- Username** – Enter a username for SNMPv3 implementation. RANGE: 1-31 Characters.
Default: admin.
- Authorized Protocol** – Select the desired protocol from the drop-down.
OPTIONS: MD5, SHA, None.
Default: MD5
- Authorized Key** – Enter an authentication key. This key acts as an electronic signature to authenticate an SNMPv3 message. RANGE: 8-32 Characters.
Default: 12345678
- Privacy Protocol** – Select the desired protocol from the drop-down. **OPTIONS: DES, None.**
Default: DES
- Privacy Key** – Enter a Privacy Key. This acts as an encryption for the data within a SNMPv3 message. RANGE: 1-8 Characters.
Default: 12345678
- Engine ID** – Enter an Engine ID. The Engine ID identifies where a SNMPv3 message is **coming from**.
Default: Blank

Configuration Instructions –

- Click **Advanced, SNMP**.
- Specify the SNMPv3 settings.
- Click **Save**, then click **Apply Changes** to enable the new settings.



14.8 - Spanning Tree Settings

Spanning Tree Protocol (STP) is an IP network protocol that prevents undesirable loops caused by multiple active paths between network devices when multiple switches or bridges are used on a network.

Figure 76. Spanning Tree Settings

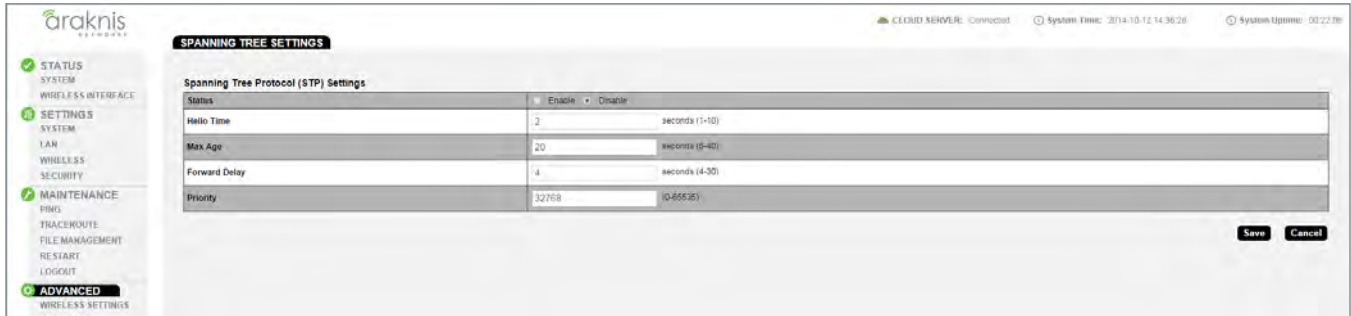

Path – Advanced, SNMP, Spanning Tree

Parameters –

- **Status** – Enable or Disable STP.
Default: Disable
- **Hello Time** – Enter a value for Hello Time. This setting will determine how often in seconds the access point will send the Hello Message to network switches and bridges to assess network topology. RANGE: 1-10 seconds.
Default: 2 seconds
- **Max Age** – Enter a duration for Max Age. This setting will determine how long the access point will wait for a Hello Message from another switch or bridge. If no message is received within the set duration, the device will be considered off-line and a new STP route will be configured. RANGE: 6-40 seconds.
Default: 20 seconds.
- **Forward Delay** – Enter a value for Forward Delay. This setting will determine the length of time the access point will take to ‘listen’ to the network and either retain current topology or generate a new topology based upon network switch and bridge status. RANGE: 4-30 seconds.
Default: 4 seconds.
- **Priority** – Enter a value for Priority from 0-65535. This setting will help determine which bridge is the root bridge, or essentially, the switch that controls the main road that network traffic is going to be routed around to avoid loops. In this game, the lowest score wins. The score is a total of MAC address, the Priority number and a bunch of tie-breaker values that determine the root bridge. Setting a lower Priority will help generate a lower score for a given switch.
Default: 32768.

Configuration Instructions –

1. Click **Advanced, Spanning Tree**.
2. Specify the spanning tree settings.
3. Click **Save**.



14.9 - VLAN Settings

A Virtual Local Area Network (VLAN) is a group of IP Network devices whose IP addresses have been set to run on a particular IP Network. These devices will typically only 'see' the other devices on their network and most likely the Internet. A VLAN ID or 'tag' can be assigned to data packets that pass through the access point to maintain the integrity of the VLAN by identifying which data belongs to which VLAN.

Figure 77. VLAN Settings

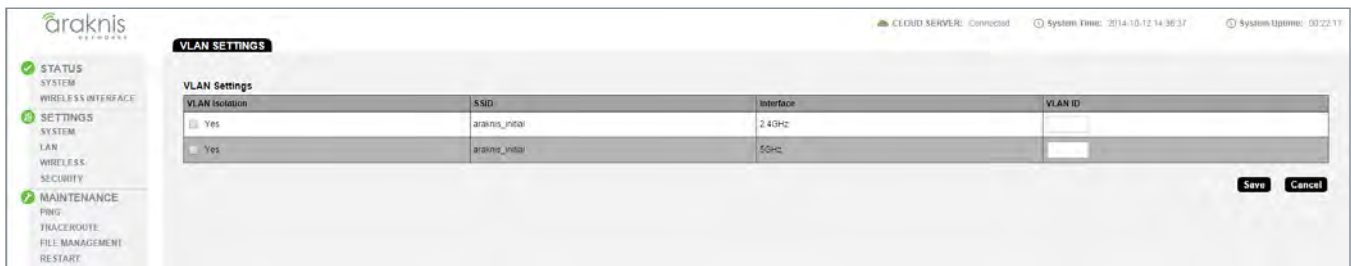

Path – Advanced, VLANS

Parameters –



Note – The AN-100 will indicate settings and information for the 2.4GHz channel. The AN-300 will indicate settings and information for the 2.4GHz and 5GHz channels.

- **VLAN Isolation** – Select Yes to assign a VLAN ID.
Default: Not selected.
- **SSID** – Indicates the network name of the VLAN being tagged. Any Wireless VLANs that need to be tagged should be added in the Wireless Settings page under Wireless Networks. If a Wireless VLAN does not appear in the VLAN Settings List, check the Wireless Settings page under Wireless Networks to see if it is enabled. If it is not, Enable, Save, then Apply.
- **Interface** – Indicates the 2.4GHz or 5GHz Interface for a given network.
- **VLAN ID** – Enter a value for the VLAN ID. RANGE: 1-4094.
Default: Blank

Configuration Instructions –

1. Click **Advanced, VLANS**.
2. Specify the vlan settings.
3. Click **Save**.



14.10 - Rogue AP Detection

Figure 78. VLAN Settings



Path - Advanced, VLANS

Parameters -

- Select Interface - .
- Detect Rogue AP -
- Detect -
- Configure Trust AP List -
- Trust APs -



15 - Troubleshooting

15.1 - Hardware Reset Procedure

If restoring factory defaults does not restore proper functionality to the AN-100/300, a hardware reset may be performed to reload the original base configuration file (saved in the access point's memory).

Figure 79. Reset Button

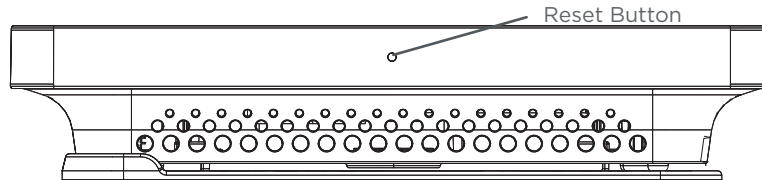

Configuration Instructions -

1. Using a paper clip or other small, blunt tool press the reset button located on the top of the access point for 30 seconds.
2. After two to four minutes, the WAP will reboot. Restart the setup process or upload a previously saved configuration



16 - Software Defaults

16.1 - Basic Menus

Item	Sub-Item	Content	AN-100 Default	AN-300 Default	Comment	
SYSTEM	System Information	System Name	an100	an300		
		Operation Mode	Access Point			
		Admin Username	araknis	araknis		
		System LED	ON	ON	ON/OFF	
		Management VLAN	Untagged	Untagged		
	Wi-Fi Scheduler	Status	Disable	Disable		
	Time Zone	Time Zone	UTC-05:00 Eastern Time	UTC-05:00 Eastern Time		
LAN	IP Settings	DHCP	Enable	Enable		
	Interface Settings	Speed	Auto	Auto		
		Duplex	Auto			
WIRELESS	Radio Settings	Enable Interface	Yes	Yes		
		Wireless Mode	802.11 B/G/N	802.11 B/G/N	2.4GHz	
				802.11 A/N	5.0GHz	
		Operating Channel	Auto	Auto		
		Channel Bandwidth	20 MHz	20 MHz		
	40 MHz		40 MHz			
		Extension Channel	Upper Channel	(Upper Channel/ N/A)		
	Wireless Networks	Enable	Yes	Yes		
		Name (SSID)	araknis_initial	araknis_initial		
		Interface	2.4GHz	Both		
		Security Mode	Open	Open	Open	
					Yes	
		Broadcast SSID	Yes	Yes		
		Channel Isolation	Disable	Disable		
Guest Network	Enable	Disable	Yes			
SECURITY	User Accounts	Username	araknis	araknis		
		Privilege Level	admin	admin		
		Access Control	HTTP Port	80	80	
		Web Access	Enable	Enable		
		Telnet	Enable	Enable		
		SSH	Disable	Disable		
	Email Alert	Status	Disable	Disable		
	Device Discovery	Bonjour	Disable	Disable		
		UPnP	Disable	Disable		



16.2 - Advanced Menus

Item	Sub-Item	Content	AN-100 Default	AN-300 Default	Comment	
WIRELESS SETTINGS	Radio Settings	Transmit Power Unit	dBm	dBm	dBm/mW	
		Data Rate	Auto	Auto		
		Transmit Power	Full 100%	Full 100%-29dBm		
		RTS/CTS Threshold (Range:1-2346)	2346	2346		
		Client Limit	Enable	No	No	
		Max Client No.	127	127		
MAC FILTER	MAC Filter Settings	Enable MAC Filter	No	No		
TRAFFIC SHAPING	Wireless Traffic Shaping	Enable	Disable	Disable		
SNMP	SNMPv2 Settings	Status	Enable	Enable		
		Port	161	161		
		Community Name (Read Only)	public	public		
		Community Name (Read Write)	private	private		
		Port	162	162	Trap Destination	
		IP Address			Trap Destination	
		Community Name	public	public	Trap Destination	
	SNMPv3 Settings	Status	Enable	Enable		
		Username	admin	admin	(1-31 Characters)	
		Authorized Protocol	MD5	MD5		
		Authorized Key	12345678	12345678		
		Privacy Protocol	DES	DES		
		Privacy Key	12345678	12345678		
		Engine ID				
SPANNING TREE	Spanning Tree Protocol (STP)	Status	Disable	Disable		
		Hello Time	2	2	seconds (1-10)	
		Max Age	20	20	seconds (6-40)	
		Forward Delay	4	4	seconds (4-30)	
		Priority	32768	32768	(0-65535)	
VLANS	VLAN Settings	VLAN Isolation	No	No		



17 - Table of Figures

Figure 1.	Package Contents	6
Figure 2.	Residential Access Point Location	8
Figure 3.	Small Commercial Access Point Location	8
Figure 4.	EIA/TIA 568B Termination Pattern	9
Figure 5.	Network Wiring Diagram	10
Figure 6.	Junction Box Mounting	11
Figure 7.	Drywall Mounting	12
Figure 8.	Ceiling Tile Mounting	12
Figure 9.	Status LED Location	13
Figure 10.	Default SSID	15
Figure 11.	EZ Setup Login Screen	15
Figure 12.	System Name Access	16
Figure 13.	Fing IP Scanner Example	17
Figure 14.	Web Interface Layout	21
Figure 15.	Applying Changes	22
Figure 16.	System Status Screen	23
Figure 17.	System Information Table	24
Figure 18.	Wireless Information	25
Figure 19.	LAN Information	26
Figure 20.	System Log	27
Figure 21.	Wireless Interface Status	28
Figure 22.	Radio Status	29
Figure 23.	Utilization of SSID Status	30
Figure 24.	Wireless Network Status	30
Figure 25.	Connected Client Status	31
Figure 26.	System Settings	32
Figure 27.	System Information	33
Figure 28.	Date and Time Settings	34
Figure 29.	Time Zone	35
Figure 30.	LAN Settings	36
Figure 31.	IP Settings	37
Figure 32.	Interface Settings	38
Figure 33.	Wireless Settings (AN-300-AP-I-N interface shown)	39
Figure 34.	Radio Settings	40
Figure 35.	Utilization of SSID Status	41
Figure 36.	Wireless Networks	42
Figure 37.	Wireless Security - WPA-PSK and WPA2-PSK Modes	43
Figure 38.	Wireless Security - WPA-PSK and WPA2-PSK Modes	44
Figure 39.	Guest Network	45



Figure 40.	Security Settings	47
Figure 41.	User Accounts	48
Figure 42.	Access Control	49
Figure 43.	Email Alert Setup Example	50
Figure 44.	Common Email Client Ports	51
Figure 45.	Device Discovery	52
Figure 46.	Schedule Settings Menu	53
Figure 47.	Auto Reboot Settings	54
Figure 48.	Auto Reboot Settings	55
Figure 49.	Wi-Fi Scheduler	56
Figure 50.	Wi-Fi Scheduler Menu	57
Figure 51.	Wi-Fi Scheduler Setup Complete	57
Figure 52.	Ping Test	58
Figure 53.	Traceroute Test	59
Figure 54.	File Management	60
Figure 55.	Configuration File	61
Figure 56.	Uploading a New Configuration File	61
Figure 57.	Restore Factory Defaults	62
Figure 58.	Firmware	63
Figure 59.	Restart	64
Figure 60.	Logout Alert	65
Figure 61.	Advanced Wireless Settings	66
Figure 62.	Radio Settings	67
Figure 63.	Client Limit Settings	68
Figure 64.	Wireless MAC Filter Settings	69
Figure 65.	MAC Filter Settings	69
Figure 66.	MAC Filter List	70
Figure 67.	WPS Settings Menu	71
Figure 68.	Site Survey Settings	72
Figure 69.	Site Survey Settings - Select Interface	72
Figure 70.	Site Survey Settings - shown with scan results	73
Figure 71.	Spectrum Analyzer Menu	74
Figure 72.	Wireless Traffic Shaping Settings	75
Figure 73.	SNMP Settings	76
Figure 74.	SNMP Settings	77
Figure 75.	SNMP Settings	78
Figure 76.	Spanning Tree Settings	79
Figure 77.	VLAN Settings	80
Figure 78.	VLAN Settings	81
Figure 79.	Reset Button	82



18 - Specifications

100/300 Series

Description	AN-100-AP-I-N	AN-300-AP-I-N
Interfaces		
RJ45 10/100/1000Base-T	1	
PoE 802.3at/af compliant	Yes	
Wireless Interface	802.11 b/g/n	802.11 a/b/g/n
Embedded Antennas	Yes	
Performance		
Antenna Type	Omni-directional	
Transmit Power	See MCS table	
Receiver Sensitivity	See MCS table	
802.11n	2x2:2 MIMO	
PHY Data Rate	Up to 300 Mbps	Up to 300 Mbps in both frequency bands
Operating Frequencies	2.4GHz	2.4GHz & 5GHz
Channel Bonding	Yes (20MHz and 40MHz)	
Memory	64MB	128MB
Flash Memory	16MB	16MB
Wireless Features		
Auto Channel Selection	Yes	
Operation Modes	Access Point	
Multiple SSIDs	Yes -up to 8	
Wireless Security	WPA2-PSK (AES + TKIP), WPA-Enterprise	
MAC Address Filtering	Yes	
Hide SSID	Yes	
Guest Network	Yes	
L2 features		
VLANs	Yes - 802.1Q	
QoS	Yes - WME 802.11e	
RJ45 Auto-sensing	Yes	
RJ45 Auto-negotiation	Yes	
Spanning Tree Protocol	Yes, 802.1d	



Description	AN-100-AP-I-N	AN-300-AP-I-N
Management		
Web Management		Yes
Telnet		Yes
SNMP v1, v2c, v3		Yes
DHCP client		Yes
System Log		Yes
Bonjour		Yes
Araknis EZ Access		Yes
UPnP		Yes
Remote Config File Download/Upload		Yes
OvrC Cloud Services		Yes
Wi-Fi Scheduler		Yes
Site Survey		Yes
LED Control		Yes
Auto Reboot		Yes
Environmental & Physical		
Dimensions (W-H-D)	6.9 x 6.9 x 1.3	
External Power Supply	12V 1A DC	12V 2A DC
Temperature Range	Operating: 32° to 122°F(0 to 50°C) Storage: -4F° to 140°F(-20°C to 60°C)	
Humidity	Operating: 90% or less Storage: 90% or less	
Certifications	CE, FCC, IC, Wi-Fi®	



MCS Table (RF Performance)

Channel Bonding	Data Range	Transmit Power (combined, dBm)	Receive Sensitivity (combined, dBm)
AN-100-AP-I-N			
802.11b @ 2.4 GHz	1 Mbps	29	≤ -93
	11 Mbps	29	≤ -90
802.11g @ 2.4 GHz	6 Mbps	28	≤ -89
	54 Mbps	25	≤ -71
802.11n HT20 @ 2.4 GHz	MCS 0/8	27	≤ -87
	MCS 7/15	24	≤ -69
802.11n HT40 @ 2.4GHz	MCS 0/8	27	≤ -87
	MCS 7/15	24	≤ -69
AN-300-AP-I-N			
802.11a @ 5GHz	6 Mbps	26	≤ 90
	54 Mbps	23	≤ -72
802.11b @ 2.4 GHz	1 Mbps	29	≤ -99
	11 Mbps	29	≤ -93
802.11g @ 2.4 GHz	6 Mbps	29	≤ -96
	54 Mbps	23	≤ -82
802.11n HT20 @ 2.4 GHz	MCS 0/8	29	≤ -97
	MCS 7/15	23	≤ -78
802.11n HT40 @ 2.4GHz	MCS 0/8	29	≤ -86
	MCS 7/15	23	≤ -69
802.11n HT20 @ 5GHz	MCS 0/8	26	≤ -89
	MCS 7/15	23	≤ -70
802.11n HT40 @ 5GHz	MCS 0/8	26	≤ -87
	MCS 7/15	23	≤ -68



500/700 Series

Description	AN-500-AP-I-AC	AN-700-AP-I-AC
Interfaces		
RJ45 10/100/1000Base-T	1	
PoE 802.3at/af compliant	Yes	
Wireless Interface	802.11 a/b/g/n/ac	802.11 a/b/g/n/ac
Embedded Antennas	Yes	
Performance		
Antenna Type	Omni-directional	
Transmit Power	See MCS table	
Receiver Sensitivity	See MCS table	
802.11n	2x2:2 MIMO	3x3:3 MIMO
PHY Data Rate	Up to 300Mbps @ 2.4GHz Up to 867Mbps @ 5GHz	Up to 450Mbps @ 2.4GHz Up to 1300Mbps @ 5GHz
Operating Frequencies	2.4GHz & 5GHz	
Channel Bonding	Yes (20MHz, 40MHz, and 80MHz)	
Max TX Power	28dBm @ 2.4GHz 26dBm @ 5GHz	
Memory	64MB	128MB
Flash Memory	16MB	16MB
Wireless Features		
Auto Channel Selection	Yes	
Operation Modes	Access Point, Repeater	
Multiple SSIDs	Yes -up to 8 per radio	
Wireless Security	WPA2-PSK (AES + TKIP), WPA-Enterprise	
MAC Address Filtering	Yes	
Hide SSID	Yes	
Guest Network	Yes	
L2 features		
VLANs	Yes - 802.1Q	
QoS	Yes - WME 802.11e	
RJ45 Auto-sensing	Yes	
RJ45 Auto-negotiation	Yes	
Spanning Tree Protocol	Yes, 802.1d	



Description	AN-500-AP-I-AC	AN-700-AP-I-AC
Management		
Web Management		Yes
Telnet		Yes
SNMP v1, v2c, v3		Yes
DHCP client		Yes
System Log		Yes
Bonjour		Yes
Araknis EZ Access		Yes
UPnP		Yes
Remote Config File Download/Upload		Yes
OvrC Cloud Services		Yes
Wi-Fi Scheduler		Yes
Site Survey		Yes
LED Control		Yes
Auto Reboot		Yes
Environmental & Physical		
Dimensions (W-H-D)	6.9" x 6.9" x 1.3"	6.9" x 6.9" x 1.6"
External Power Supply	12V 2A DC	
Temperature Range	Operating: 32° to 122°F(0 to 50°C) Storage: -4F° to 140°F(-20°C to 60°C)	
Humidity	Operating: 90% or less Storage: 90% or less	
Certifications	CE, FCC, IC, Wi-Fi®	



MCS Table (RF Performance)

Channel Bonding	Data Range	Transmit Power (combined, dBm)	Receive Sensitivity (combined, dBm)
AN-500-AP-I-AC			
802.11b @ 2.4 GHz	1 Mbps	29	≤ -93
	11 Mbps	29	≤ -90
802.11g @ 2.4 GHz	6 Mbps	28	≤ -89
	54 Mbps	25	≤ -71
802.11n HT20 @ 2.4 GHz	MCS 0/8	27	≤ -87
	MCS 7/15	24	≤ -69
802.11n HT40 @ 2.4GHz	MCS 0/8	27	≤ -87
	MCS 7/15	24	≤ -69
AN-700-AP-I-AC			
802.11a @ 5GHz	6 Mbps	26	≤ 90
	54 Mbps	23	≤ -72
802.11b @ 2.4 GHz	1 Mbps	29	≤ -99
	11 Mbps	29	≤ -93
802.11g @ 2.4 GHz	6 Mbps	29	≤ -96
	54 Mbps	23	≤ -82
802.11n HT20 @ 2.4 GHz	MCS 0/8	29	≤ -97
	MCS 7/15	23	≤ -78
802.11n HT40 @ 2.4GHz	MCS 0/8	29	≤ -86
	MCS 7/15	23	≤ -69
802.11n HT20 @ 5GHz	MCS 0/8	26	≤ -89
	MCS 7/15	23	≤ -70
802.11n HT40 @ 5GHz	MCS 0/8	26	≤ -87
	MCS 7/15	23	≤ -68

^^TBD^^



CE Warning

This is a product with CE certification. In a domestic environment, this product may cause radio interference, in which case the user may be required to take adequate measures.

AN-100-AP-I-N FCC Statement

Federal Communication Commission Interference Statement

This device complies with Part 15 of the FCC Rules. Operation is subject to the following two conditions: (1) This device may not cause harmful interference, and (2) this device must accept any interference received, including interference that may cause undesired operation.

This equipment has been tested and found to comply with the limits for a Class B digital device, pursuant to Part 15 of the FCC Rules. These limits are designed to provide reasonable protection against harmful interference in a residential installation. This equipment generates, uses, and can radiate radio frequency energy and, if not installed and used in accordance with the instructions, may cause harmful interference to radio communications. However, there is no guarantee that interference will not occur in a particular installation. If this equipment does cause harmful interference to radio or television reception, which can be determined by turning the equipment off and on, the user is encouraged to try to correct the interference by one of the following measures:

- Reorient or relocate the receiving antenna.
- Increase the separation between the equipment and receiver.
- Connect the equipment into an outlet on a circuit different from that to which the receiver is connected.
- Consult the dealer or an experienced radio/TV technician for help.

FCC Caution: Any changes or modifications not expressly approved by the party responsible for compliance could void the user's authority to operate this equipment.

This transmitter must not be co-located or operating in conjunction with any other antenna or transmitter.

Radiation Exposure Statement:

This equipment complies with FCC radiation exposure limits set forth for an uncontrolled environment. This equipment should be installed and operated with minimum distance 20cm between the radiator & your body.

Industry Canada statement:

This device complies with RSS-210 of the Industry Canada Rules. Operation is subject to the following two conditions: (1) This device may not cause harmful interference, and (2) this device must accept any interference received, including interference that may cause undesired operation.

Ce dispositif est conforme à la norme CNR-210 d'Industrie Canada applicable aux appareils radio exempts de licence. Son fonctionnement est sujet aux deux conditions suivantes: (1) le dispositif ne doit pas produire de brouillage préjudiciable, et (2) ce dispositif doit accepter tout brouillage reçu, y compris un brouillage susceptible de provoquer un fonctionnement indésirable.

Radiation Exposure Statement:

This equipment complies with IC radiation exposure limits set forth for an uncontrolled environment. This equipment should be installed and operated with minimum distance 20cm between the radiator & your body.



Déclaration d'exposition aux radiations:

Cet équipement est conforme aux limites d'exposition aux rayonnements IC établies pour un environnement non contrôlé. Cet équipement doit être installé et utilisé avec un minimum de 20 cm de distance entre la source de rayonnement et votre corps.

Europe - EU Declaration of Conformity

This device complies with the essential requirements of the R&TTE Directive 1999/5/EC. The following test methods have been applied in order to prove presumption of conformity with the essential requirements of the R&TTE Directive 1999/5/EC:

- **EN60950-1**
Safety of Information Technology Equipment
- **EN50385**
Generic standard to demonstrate the compliance of electronic and electrical apparatus with the basic restrictions related to human exposure to electromagnetic fields (0 Hz - 300 GHz)
- **EN 300 328**
Electromagnetic compatibility and Radio spectrum Matters (ERM); Wideband Transmission systems; Data transmission equipment operating in the 2,4 GHz ISM band and using spread spectrum modulation techniques; Harmonized EN covering essential requirements under article 3.2 of the R&TTE Directive
- **EN 301 489-1**
Electromagnetic compatibility and Radio Spectrum Matters (ERM); ElectroMagnetic Compatibility (EMC) standard for radio equipment and services; Part 1: Common technical requirements
- **EN 301 489-17**
Electromagnetic compatibility and Radio spectrum Matters (ERM); ElectroMagnetic Compatibility (EMC) standard for radio equipment and services; Part 17: Specific conditions for 2,4 GHz wideband transmission systems and 5 GHz high performance RLAN equipment

CE 0560

Česky [Czech]	Araknis Networks tímto prohlašuje, že tento wireless access point je ve shodě se základními požadavky a dalšími příslušnými ustanoveními směrnice 1999/5/ES.
Dansk [Danish]	Undertegnede Araknis Networks erklærer herved, at følgende udstyr wireless access point overholder de væsentlige krav og øvrige relevante krav i direktiv 1999/5/EF.
Deutsch [German]	Hiermit erklärt Araknis Networks, dass sich das Gerät wireless access point in Übereinstimmung mit den grundlegenden Anforderungen und den übrigen einschlägigen Bestimmungen der Richtlinie 1999/5/EG befindet.
Eesti [Estonian]	Käesolevaga kinnitab Araknis Networks seadme wireless access point vastavust direktiivi 1999/5/EÜ põhinõuetele ja nimetatud direktiivist tulenevatele teistele asjakohastele sätetele.
English	Hereby, Araknis Networks , declares that this wireless access point is in compliance with the essential requirements and other relevant provisions of Directive 1999/5/ EC.



Español [Spanish]	Por medio de la presente Araknis Networks declara que el wireless access point cumple con los requisitos esenciales y cualesquiera otras disposiciones aplicables o exigibles de la Directiva 1999/5/CE.
Ελληνική [Greek]	ΜΕ ΤΗΝ ΠΑΡΟΥΣΑ Araknis Networks ΔΗΛΩΝΕΙ ΟΤΙ wireless access point ΣΥΜΜΟΡΦΩΝΕΤΑΙ ΠΡΟΣ ΤΙΣ ΟΥΣΙΩΔΕΙΣ ΑΠΑΙΤΗΣΕΙΣ ΚΑΙ ΤΙΣ ΛΟΙΠΕΣ ΣΧΕΤΙΚΕΣ ΔΙΑΤΑΞΕΙΣ ΤΗΣ ΟΔΗΓΙΑΣ 1999/5/ΕΚ.
Français [French]	Par la présente Araknis Networks déclare que l'appareil wireless access point est conforme aux exigences essentielles et aux autres dispositions pertinentes de la directive 1999/5/CE.
Italiano [Italian]	Con la presente Araknis Networks dichiara che questo wireless access point è conforme ai requisiti essenziali ed alle altre disposizioni pertinenti stabilite dalla direttiva 1999/5/CE.
Latviski [Latvian]	Ar šo Araknis Networks deklarē, ka wireless access point atbilst Direktīvas 1999/5/EK būtiskajām prasībām un citiem ar to saistītajiem noteikumiem.
Lietuvių [Lithuanian]	Šiuo Araknis Networks deklaruoja, kad šis wireless access point atitinka esminius reikalavimus ir kitas 1999/5/EB Direktyvos nuostatas.
Nederlands [Dutch]	Hierbij verklaart Araknis Networks dat het toestel wireless access point in overeenstemming is met de essentiële eisen en de andere relevante bepalingen van richtlijn 1999/5/EG.
Malti [Maltese]	Hawnhekk, Araknis Networks, jiddikjara li dan wireless access point jikkonforma mal-ħtiġijiet essenzjali u ma provvedimenti oħrajn rilevanti li hemm fid-Dirrettiva 1999/5/EC.
Magyar [Hungarian]	Alulírott, Araknis Networks nyilatkozom, hogy a wireless access point megfelel a vonatkozó alapvető követelményeknek és az 1999/5/EC irányelv egyéb előírásainak.
Polski [Polish]	Niniejszym Araknis Networks oświadcza, że wireless access point jest zgodny z zasadniczymi wymogami oraz pozostałymi stosownymi postanowieniami Dyrektywy 1999/5/EC.
Português [Portuguese]	Araknis Networks declara que este wireless access point está conforme com os requisitos essenciais e outras disposições da Directiva 1999/5/CE.
Slovensko [Slovenian]	Araknis Networks izjavlja, da je ta wireless access point v skladu z bistvenimi zahtevami in ostalimi relevantnimi določili direktive 1999/5/ES.
Slovensky [Slovak]	Araknis Networks týmto vyhlasuje, že wireless access point spĺňa základné požiadavky a všetky príslušné ustanovenia Smernice 1999/5/ES.
Suomi [Finnish]	Araknis Networks vakuuttaa täten että wireless access point tyyppinen laite on direktiivin 1999/5/EY oleellisten vaatimusten ja sitä koskevien direktiivin muiden ehtojen mukainen.
Svenska [Swedish]	Härmed intygar Araknis Networks att denna wireless access point står i överensstämmelse med de väsentliga egenskapskrav och övriga relevanta bestämmelser som framgår av direktiv 1999/5/EG.



AN-300-AP-I-N FCC Statement

Federal Communication Commission Interference Statement

This equipment has been tested and found to comply with the limits for a Class B digital device, pursuant to Part 15 of the FCC Rules. These limits are designed to provide reasonable protection against harmful interference in a residential installation. This equipment generates, uses and can radiate radio frequency energy and, if not installed and used in accordance with the instructions, may cause harmful interference to radio communications. However, there is no guarantee that interference will not occur in a particular installation. If this equipment does cause harmful interference to radio or television reception, which can be determined by turning the equipment off and on, the user is encouraged to try to correct the interference by one of the following measures:

- Reorient or relocate the receiving antenna.
- Increase the separation between the equipment and receiver.
- Connect the equipment into an outlet on a circuit different from that to which the receiver is connected.
- Consult the dealer or an experienced radio/TV technician for help.

FCC Caution: Any changes or modifications not expressly approved by the party responsible for compliance could void the user's authority to operate this equipment.

This device complies with Part 15 of the FCC Rules. Operation is subject to the following two conditions: (1) This device may not cause harmful interference, and (2) this device must accept any interference received, including interference that may cause undesired operation.

This transmitter must not be co-located or operating in conjunction with any other antenna or transmitter.

Operations in the 5.15-5.25GHz band are restricted to indoor usage only.

IMPORTANT NOTE:

FCC Radiation Exposure Statement:

This equipment complies with FCC radiation exposure limits set forth for an uncontrolled environment. This equipment should be installed and operated with minimum distance 21cm between the radiator & your body.

Industry Canada Statement:

This device complies with RSS-210 of the Industry Canada Rules. Operation is subject to the following two conditions: (1) This device may not cause harmful interference, and (2) this device must accept any interference received, including interference that may cause undesired operation.

Ce dispositif est conforme à la norme CNR-210 d'Industrie Canada applicable aux appareils radio exempts de licence. Son fonctionnement est sujet aux deux conditions suivantes: (1) le dispositif ne doit pas produire de brouillage préjudiciable, et (2) ce dispositif doit accepter tout brouillage reçu, y compris un brouillage susceptible de provoquer un fonctionnement indésirable.

Caution:

- (i) The device for operation in the band 5150-5250 MHz is only for indoor use to reduce the potential for harmful interference to co-channel mobile satellite systems;
- (ii) high-power radars are allocated as primary users (i.e. priority users) of the bands 5250-5350 MHz and 5650-5850 MHz and that these radars could cause interference and/or damage to LE-LAN devices.



Avertissement:

- (i) les dispositifs fonctionnant dans la bande 5150-5250 MHz sont réservés uniquement pour une utilisation à l'intérieur afin de réduire les risques de brouillage préjudiciable aux systèmes de satellites mobiles utilisant les mêmes canaux;
- (ii) De plus, les utilisateurs devraient aussi être avisés que les utilisateurs de radars de haute puissance sont désignés utilisateurs principaux (c.-à-d., qu'ils ont la priorité) pour les bandes 5250-5350 MHz et 5650-5850 MHz et que ces radars pourraient causer du brouillage et/ou des dommages aux dispositifs LAN-EL.

FOR MOBILE DEVICE USAGE

Radiation Exposure Statement:

This equipment complies with IC radiation exposure limits set forth for an uncontrolled environment. This equipment should be installed and operated with minimum distance 21cm between the radiator & your body.

Déclaration d'exposition aux radiations:

Cet équipement est conforme aux limites d'exposition aux rayonnements IC établies pour un environnement non contrôlé. Cet équipement doit être installé et utilisé avec un minimum de 21cm de distance entre la source de rayonnement et votre corps.

Europe - EU Declaration of Conformity

This device complies with the essential requirements of the R&TTE Directive 1999/5/EC. The following test methods have been applied in order to prove presumption of conformity with the essential requirements of the R&TTE Directive 1999/5/EC:

- **EN60950-1**
Safety of Information Technology Equipment
- **EN50385**
Generic standard to demonstrate the compliance of electronic and electrical apparatus with the basic restrictions related to human exposure to electromagnetic fields (0 Hz - 300 GHz)
- **EN 300 328**
Electromagnetic compatibility and Radio spectrum Matters (ERM); Wideband Transmission systems; Data transmission equipment operating in the 2,4 GHz ISM band and using spread spectrum modulation techniques; Harmonized EN covering essential requirements under article 3.2 of the R&TTE Directive
- **EN 301 893**
Broadband Radio Access Networks (BRAN); 5 GHz high performance RLAN; Harmonized EN covering essential requirements of article 3.2 of the R&TTE Directive
- **EN 301 489-1**
Electromagnetic compatibility and Radio Spectrum Matters (ERM); ElectroMagnetic Compatibility (EMC) standard for radio equipment and services; Part 1: Common technical requirements
- **EN 301 489-17**
Electromagnetic compatibility and Radio spectrum Matters (ERM); ElectroMagnetic Compatibility (EMC) standard for radio equipment and services; Part 17: Specific conditions for 2,4 GHz wideband transmission systems and 5 GHz high performance RLAN equipment

This device is a 5GHz wideband transmission system (transceiver), intended for use in all EU member states and EFTA countries, except in France and Italy where restrictive use applies.

In Italy the end-user should apply for a license at the national spectrum authorities in order to obtain authorization to use the device for setting up outdoor radio links and/or for supplying public access to telecommunications and/or network services.

This device may not be used for setting up outdoor radio links in France and in some areas the RF output power may be limited to 10 mW EIRP in the frequency range of 2454 - 2483.5 MHz. For detailed information the end-user should contact the national spectrum authority in France.

CE 0560

Česky [Czech]	Araknis Networks tímto prohlašuje, že tento wireless access point je ve shodě se základními požadavky a dalšími příslušnými ustanoveními směrnice 1999/5/ES.
Dansk [Danish]	Undertegnede Araknis Networks erklærer herved, at følgende udstyr wireless access point overholder de væsentlige krav og øvrige relevante krav i direktiv 1999/5/EF.
Deutsch [German]	Hiermit erklärt Araknis Networks, dass sich das Gerät wireless access point in Übereinstimmung mit den grundlegenden Anforderungen und den übrigen einschlägigen Bestimmungen der Richtlinie 1999/5/EG befindet.
Eesti [Estonian]	Käesolevaga kinnitab Araknis Networks seadme wireless access point vastavust direktiivi 1999/5/EÜ põhinõuetele ja nimetatud direktiivist tulenevatele teistele asjakohastele sätetele.
English	Hereby, Araknis Networks, declares that this wireless access point is in compliance with the essential requirements and other relevant provisions of Directive 1999/5/EC.
Español [Spanish]	Por medio de la presente Araknis Networks declara que el wireless access point cumple con los requisitos esenciales y cualesquiera otras disposiciones aplicables o exigibles de la Directiva 1999/5/CE.
Ελληνική [Greek]	ΜΕ ΤΗΝ ΠΑΡΟΥΣΑ Araknis Networks ΔΗΛΩΝΕΙ ΟΤΙ wireless access point ΣΥΜΜΟΡΦΩΝΕΤΑΙ ΠΡΟΣ ΤΙΣ ΟΥΣΙΩΔΕΙΣ ΑΠΑΙΤΗΣΕΙΣ ΚΑΙ ΤΙΣ ΛΟΙΠΕΣ ΣΧΕΤΙΚΕΣ ΔΙΑΤΑΞΕΙΣ ΤΗΣ ΟΔΗΓΙΑΣ 1999/5/ΕΚ.
Français [French]	Par la présente Araknis Networks déclare que l'appareil wireless access point est conforme aux exigences essentielles et aux autres dispositions pertinentes de la directive 1999/5/CE.
Italiano [Italian]	Con la presente Araknis Networks dichiara che questo wireless access point è conforme ai requisiti essenziali ed alle altre disposizioni pertinenti stabilite dalla direttiva 1999/5/CE.
Latviski [Latvian]	Ar šo Araknis Networks deklarē, ka wireless access point atbilst Direktīvas 1999/5/EK būtiskajām prasībām un citiem ar to saistītajiem noteikumiem.
Lietuvių [Lithuanian]	Šiuo Araknis Networks deklaruoja, kad šis wireless access point atitinka esminius reikalavimus ir kitas 1999/5/EB Direktyvos nuostatas.
Nederlands [Dutch]	Hierbij verklaart Araknis Networks dat het toestel wireless access point in overeenstemming is met de essentiële eisen en de andere relevante bepalingen van richtlijn 1999/5/EG.



Malti [Maltese]	Hawnhekk, Araknis Networks, jiddikjara li dan wireless access point jikkonforma mal-ħtiġijiet essenzjali u ma provvedimenti oħrajn relevanti li hemm fid-Dirrettiva 1999/5/EC.
Magyar [Hungarian]	Alulírott, Araknis Networks nyilatkozom, hogy a wireless access point megfelel a vonatkozó alapvető követelményeknek és az 1999/5/EC irányelv egyéb előírásainak.
Polski [Polish]	Niniejszym Araknis Networks oświadcza, że wireless access point jest zgodny z zasadniczymi wymogami oraz pozostałymi stosownymi postanowieniami Dyrektywy 1999/5/EC.
Português [Portuguese]	Araknis Networks declara que este wireless access point está conforme com os requisitos essenciais e outras disposições da Directiva 1999/5/CE.
Slovensko [Slovenian]	Araknis Networks izjavlja, da je ta wireless access point v skladu z bistvenimi zahtevami in ostalimi relevantnimi določili direktive 1999/5/ES.
Slovensky [Slovak]	Araknis Networks týmto vyhlasuje, že wireless access point spĺňa základné požiadavky a všetky príslušné ustanovenia Smernice 1999/5/ES.
Suomi [Finnish]	Araknis Networks vakuuttaa täten että wireless access point tyyppinen laite on direktiivin 1999/5/EY oleellisten vaatimusten ja sitä koskevien direktiivin muiden ehtojen mukainen.
Svenska [Swedish]	Härmed intygar Araknis Networks att denna wireless access point står i överensstämmelse med de väsentliga egenskapskrav och övriga relevanta bestämmelser som framgår av direktiv 1999/5/EG.



AN-500/700-AP-I-AC FCC Statement

Federal Communication Commission Interference Statement

This equipment has been tested and found to comply with the limits for a Class B digital device, pursuant to Part 15 of the FCC Rules. These limits are designed to provide reasonable protection against harmful interference in a residential installation. This equipment generates, uses and can radiate radio frequency energy and, if not installed and used in accordance with the instructions, may cause harmful interference to radio communications. However, there is no guarantee that interference will not occur in a particular installation. If this equipment does cause harmful interference to radio or television reception, which can be determined by turning the equipment off and on, the user is encouraged to try to correct the interference by one of the following measures:

Reorient or relocate the receiving antenna.

Increase the separation between the equipment and receiver.

Connect the equipment into an outlet on a circuit different from that to which the receiver is connected.

Consult the dealer or an experienced radio/TV technician for help.

FCC Caution: Any changes or modifications not expressly approved by the party responsible for compliance could void the user's authority to operate this equipment.

This device complies with Part 15 of the FCC Rules. Operation is subject to the following two conditions: (1) This device may not cause harmful interference, and (2) this device must accept any interference received, including interference that may cause undesired operation.

This transmitter must not be co-located or operating in conjunction with any other antenna or transmitter.

Operations in the 5.15-5.25GHz band are restricted to indoor usage only.

IMPORTANT NOTE:

FCC Radiation Exposure Statement:

This equipment complies with FCC radiation exposure limits set forth for an uncontrolled environment. This equipment should be installed and operated with minimum distance 21cm between the radiator & your body.

Industry Canada statement:

This device complies with RSS-210 of the Industry Canada Rules. Operation is subject to the following two conditions: (1) This device may not cause harmful interference, and (2) this device must accept any interference received, including interference that may cause undesired operation.

Ce dispositif est conforme à la norme CNR-210 d'Industrie Canada applicable aux appareils radio exempts de licence. Son fonctionnement est sujet aux deux conditions suivantes: (1) le dispositif ne doit pas produire de brouillage préjudiciable, et (2) ce dispositif doit accepter tout brouillage reçu, y compris un brouillage susceptible de provoquer un fonctionnement indésirable.



Caution:

- (i) the device for operation in the band 5150-5250 MHz is only for indoor use to reduce the potential for harmful interference to co-channel mobile satellite systems;
- (ii) high-power radars are allocated as primary users (i.e. priority users) of the bands 5250-5350 MHz and 5650-5850 MHz and that these radars could cause interference and/or damage to LE-LAN devices.

Avertissement:

- (i) les dispositifs fonctionnant dans la bande 5150-5250 MHz sont réservés uniquement pour une utilisation à l'intérieur afin de réduire les risques de brouillage préjudiciable aux systèmes de satellites mobiles utilisant les mêmes canaux;
- (ii) De plus, les utilisateurs devraient aussi être avisés que les utilisateurs de radars de haute puissance sont désignés utilisateurs principaux (c.-à-d., qu'ils ont la priorité) pour les bandes 5250-5350 MHz et 5650-5850 MHz et que ces radars pourraient causer du brouillage et/ou des dommages aux dispositifs LAN-EL.

FOR MOBILE DEVICE USAGE

Radiation Exposure Statement:

This equipment complies with IC radiation exposure limits set forth for an uncontrolled environment. This equipment should be installed and operated with minimum distance 22cm between the radiator & your body.

Déclaration d'exposition aux radiations:

Cet équipement est conforme aux limites d'exposition aux rayonnements IC établies pour un environnement non contrôlé. Cet équipement doit être installé et utilisé avec un minimum de 22cm de distance entre la source de rayonnement et votre corps.

Europe - EU Declaration of Conformity

This device complies with the essential requirements of the R&TTE Directive 1999/5/EC. The following test methods have been applied in order to prove presumption of conformity with the essential requirements of the R&TTE Directive 1999/5/EC:

EN60950-1

Safety of Information Technology Equipment

EN50385

Generic standard to demonstrate the compliance of electronic and electrical apparatus with the basic restrictions related to human exposure to electromagnetic fields (0 Hz - 300 GHz)

EN 300 328

Electromagnetic compatibility and Radio spectrum Matters (ERM); Wideband Transmission systems; Data transmission equipment operating in the 2,4 GHz ISM band and using spread spectrum modulation techniques; Harmonized EN covering essential requirements under article 3.2 of the R&TTE Directive

EN 301 893

Broadband Radio Access Networks (BRAN); 5 GHz high performance RLAN; Harmonized EN covering essential requirements of article 3.2 of the R&TTE Directive

EN 301 489-1

Electromagnetic compatibility and Radio Spectrum Matters (ERM); ElectroMagnetic Compatibility (EMC) standard for radio equipment and services; Part 1: Common technical requirements

EN 301 489-17

Electromagnetic compatibility and Radio spectrum Matters (ERM); ElectroMagnetic Compatibility (EMC) standard for radio equipment and services; Part 17: Specific conditions for 2,4 GHz wideband transmission systems and 5 GHz high performance RLAN equipment



Česky [Czech]	Araknis Networks tímto prohlašuje, že tento wireless access point je ve shodě se základními požadavky a dalšími příslušnými ustanoveními směrnice 1999/5/ES.
Dansk [Danish]	Undertegnede Araknis Networks erklærer herved, at følgende udstyr wireless access point overholder de væsentlige krav og øvrige relevante krav i direktiv 1999/5/EF.
Deutsch [German]	Hiermit erklärt Araknis Networks, dass sich das Gerät wireless access point in Übereinstimmung mit den grundlegenden Anforderungen und den übrigen einschlägigen Bestimmungen der Richtlinie 1999/5/EG befindet.
Eesti [Estonian]	Käesolevaga kinnitab Araknis Networks seadme wireless access point vastavust direktiivi 1999/5/EÜ põhinõuetele ja nimetatud direktiivist tulenevatele teistele asjakohastele sätetele.
English	Hereby, Araknis Networks, declares that this wireless access point is in compliance with the essential requirements and other relevant provisions of Directive 1999/5/EC.
Español [Spanish]	Por medio de la presente Araknis Networks declara que el wireless access point cumple con los requisitos esenciales y cualesquiera otras disposiciones aplicables o exigibles de la Directiva 1999/5/CE.
Ελληνική [Greek]	ΜΕ ΤΗΝ ΠΑΡΟΥΣΑ Araknis Networks ΔΗΛΩΝΕΙ ΟΤΙ wireless access point ΣΥΜΜΟΡΦΩΝΕΤΑΙ ΠΡΟΣ ΤΙΣ ΟΥΣΙΩΔΕΙΣ ΑΠΑΙΤΗΣΕΙΣ ΚΑΙ ΤΙΣ ΛΟΙΠΕΣ ΣΧΕΤΙΚΕΣ ΔΙΑΤΑΞΕΙΣ ΤΗΣ ΟΔΗΓΙΑΣ 1999/5/ΕΚ.
Français [French]	Par la présente Araknis Networks déclare que l'appareil wireless access point est conforme aux exigences essentielles et aux autres dispositions pertinentes de la directive 1999/5/CE.
Italiano [Italian]	Con la presente Araknis Networks dichiara che questo wireless access point è conforme ai requisiti essenziali ed alle altre disposizioni pertinenti stabilite dalla direttiva 1999/5/CE.
Latviski [Latvian]	Ar šo Araknis Networks deklarē, ka wireless access point atbilst Direktīvas 1999/5/EK būtiskajām prasībām un citiem ar to saistītajiem noteikumiem.
Lietuvių [Lithuanian]	Šiuo Araknis Networks deklaruoja, kad šis wireless access point atitinka esminius reikalavimus ir kitas 1999/5/EB Direktyvos nuostatas.



Nederlands [Dutch]	Hierbij verklaart Araknis Networks dat het toestel wireless access point in overeenstemming is met de essentiële eisen en de andere relevante bepalingen van richtlijn 1999/5/EG.
Malti [Maltese]	Hawnhekk, Araknis Networks, jiddikjara li dan wireless access point jikkonforma mal-ħtiġijiet essenzjali u ma provvedimenti oħrajn relevanti li hemm fid-Dirrettiva 1999/5/EC.
Magyar [Hungarian]	Alulírott, Araknis Networks nyilatkozom, hogy a wireless access point megfelel a vonatkozó alapvető követelményeknek és az 1999/5/EC irányelv egyéb előírásainak.
Polski [Polish]	Niniejszym Araknis Networks oświadcza, że wireless access point jest zgodny z zasadniczymi wymogami oraz pozostałymi stosownymi postanowieniami Dyrektywy 1999/5/EC.
Português [Portuguese]	Araknis Networks declara que este wireless access point está conforme com os requisitos essenciais e outras disposições da Directiva 1999/5/CE.
Slovensko [Slovenian]	Araknis Networks izjavlja, da je ta wireless access point v skladu z bistvenimi zahtevami in ostalimi relevantnimi določili direktive 1999/5/ES.
Slovensky [Slovak]	Araknis Networks týmto vyhlasuje, že wireless access point spĺňa základné požiadavky a všetky príslušné ustanovenia Smernice 1999/5/ES.
Suomi [Finnish]	Araknis Networks vakuuttaa täten että wireless access point tyyppinen laite on direktiivin 1999/5/EY oleellisten vaatimusten ja sitä koskevien direktiivin muiden ehtojen mukainen.
Svenska [Swedish]	Härmed intygar Araknis Networks att denna wireless access point står i överensstämmelse med de väsentliga egenskapskrav och övriga relevanta bestämmelser som framgår av direktiv 1999/5/EG.



2-Year Limited Warranty

Araknis Networks® products have a 2-Year Limited Warranty. This warranty includes parts and labor repairs on all components found to be defective in material or workmanship under normal conditions of use. This warranty shall not apply to products that have been abused, modified, or disassembled. Products to be repaired under this warranty must be returned to SnapAV or a designated service center with prior notification and an assigned return authorization number (RA).

Contacting Technical Support

P: (866) 838-5052

E: Techsupport@araknisnetworks.com



© 2016 Araknis Networks®

160225-1513