

Velocity 111 User Manual

This is only the beginning.

We are constantly enhancing and improving our user experience. For the latest information on what we've added and how it works visit us online.

www.velocitymobile.com

Copyright © 2008 Velocity Mobile All Rights Reserved.

No part of this manual, including the product and software described in it, may be reproduced, transmitted, transcribed, stored in a retrieval system, or translated into any language in any form, by any means, without prior written permission from Velocity Mobile.

Velocity Mobile provides this publication “as is” without warranty of any kind. This information could include technical inaccuracies or typographical errors. Velocity Mobile may make improvements and/or changes in the product. Information and specifications contained in this document are subject to change at any time without notice.

The information contained in this document does not affect or change the product specifications or warranties. Velocity Mobile is not liable for any damages resulting from the use of this product.

IMPORTANT PRECAUTIONS

Please read the following information carefully before you start using the Velocity 111 to avoid any damage caused by improper usage:

- The device is not charged when you take it out of the box. The battery should be charged for at least 8 hours before first use. Do not remove the battery while charging.
- Do not service any product yourself. Service needed on components inside these compartments should be done by an authorized service technician or provider.
- Do not use batteries which have not been specified by the manufacturer, as this may cause leakage or rupture. Damage caused by using batteries not specified by the manufacturer is not covered under warranty.
- Do not charge the battery with an unspecified AC Adapter, as this may cause damage to both the device and the battery.
- Do not leave the AC adapter in places where the temperature may be lower than -20°C (-4°F) or higher than 70°C (158°F) as this may damage the AC adaptor.
- When discarding the batteries, dispose of them in a proper manner, according to the battery manufacturer’s instructions and your local laws.
- Power off the device and remove the battery before inserting SIM card. Make sure the SIM card snaps correctly into the SIM socket.
- Do not open or tamper with the device cover, as this will void your warranty.
- Do not press hard on this product, as it may cause damage to the screen or the internal components.
- Do not use the device at gas or refueling stations, chemical plants, and places containing explosives or flammable materials. The product should be placed away from heat sources such as radiators, stoves, or other products (including amplifiers) that produce heat.
- Do not strike, shake, or heat the device in a way which may cause battery leakage or rupture and damage to the device.
- Use only a manufacturer-specified stylus. Do not scratch the screen or otherwise bring it into contact with any hard objects (e.g. loose change in your pocket).
- Do not clean the screen with chemical detergents. Only use cloths specifically designed for cleaning liquid-crystal displays. Unplug the product from the wall outlet before cleaning. Do not use liquid cleaners or aerosol cleaners. Use a damp cloth for cleaning, but NEVER use water to clean the LCD screen.
- Do not expose the device to prolonged direct sunlight, or leave the device in a humid environment for extended periods of time, as this may cause damage to the device and battery.
- Do not immerse the device in water. Never use the product in a wet location.
- The device may interfere with the navigation and/or communication systems on aircraft. The use of the device on an aircraft is prohibited by laws in most countries.
- This product may cause medical equipment to malfunction. The use of this device is forbidden in most hospitals and medical clinics.
- Always use hands-free devices, if you need to use the telephony services, while driving a vehicle.
- Please turn down the volume before using headphones or other audio devices.
- Do not place the product on an unstable base.
- Do not push objects of any kind into cabinet slots or other openings in the device.
- The device should be operated from the type of power indicated on the marking label. If there are noticeable signs of overheating, unplug the device from the electrical outlet immediately and refer servicing to an authorized service provider.
- **Warning:** Do not remove or damage the warranty void label on the device, as this will void your warranty.

Non-ionizing Radiation

This product should be operated only in the suggested typical conditions to ensure good radiative performance and safety from interference. For safety reasons, as with all other mobile radio-transmitting equipment, it is recommended that no part of the human body be allowed to come too close to the antenna during operation of the equipment.

Trademark Information

Microsoft, MS-DOS, Windows, Windows NT, Windows Server, Window Vista, Windows Mobile, ActiveSync, Excel, Internet Explorer, Windows Live, Outlook, PowerPoint, and Word are either registered trademarks or trademarks of Microsoft Corporation in the United States and/or other countries.

All other trademarks are property of their respective owners.

Table of Contents

VELOCITY 111 USER MANUAL	1
CHAPTER 1: OVERVIEW	6
1.1 INTRODUCTION	6
1.2 INTRODUCTION CONT.	8
1.3 INSTALLING SIM CARD, BATTERY AND MICRO SD CARD.....	9
1.4 BATTERY INFORMATION.....	11
CHAPTER 2: BASIC OPERATIONS.....	13
2.1 GETTING STARTED.....	13
2.2 TODAY SCREEN.....	14
2.3 VOTA (VELOCITY OVER THE AIR)	16
2.4 VELOCITY TOOLBAR.....	17
2.5 START MENU	17
2.6 PROGRAMS, SETTINGS AND ICONS	18
2.7 INPUT METHODS.....	20
CHAPTER 3: SYNCHRONIZING INFORMATION.....	23
3.1 INSTALLING AND SETTING UP ACTIVE SYNC	23
3.2 INSTALLING AND SETTING UP WMDC	23
3.3 SYNCHRONIZING INFORMATION.....	24
3.4 CHANGING SETTINGS FOR AN INFORMATION TYPE	24
3.5 SYNCHRONIZING WITH EXCHANGE SERVER.....	25
3.6 SYNCHRONIZING VIA BLUETOOTH	25
CHAPTER 4: PHONE.....	26
4.1 MAKING A CALL	26
4.2 CONFIGURING THE PHONE	28
4.3 VOICE CALL IN-CALL OPTIONS	30
4.4 VIDEO CALL IN-CALL OPTIONS	31
CHAPTER 5: CONTACTS & MESSAGING	33
5.1 USING CONTACTS	33
5.2 TEXT MESSAGING.....	34
5.3 MULTIMEDIA MESSAGING SERVICE	35
5.4 E-MAIL	36
5.5 USING SIM MANAGER.....	38
CHAPTER 6: BASIC APPLICATIONS	40
6.1 USING CALENDAR	40
6.2 USING NOTES	41
6.3 USING TASKS	43
CHAPTER 7: CONNECTING TO THE INTERNET	45
7.1 SETTING UP INTERNET CONNECTIONS	45
7.2 USING A WI-FI CONNECTION	47
7.3 USING WIRELESS MANAGER	49
7.4 USING INTERNET EXPLORER MOBILE.....	50
CHAPTER 8: TRANSFERRING FILES TO AND FROM THE DEVICE.....	53
8.1 USING ACTIVE SYNC	53
8.2 TRANSFERRING FROM MEMORY CARDS.....	53
8.3 USING BLUETOOTH.....	54

CHAPTER 9: OTHER APPLICATIONS.....	56
9.1 WINDOWS LIVE MESSENGER	56
9.2 JETCET PDF5	57
9.3 WINDOWS MEDIA	58
9.4 MIDLET MANAGER	59
9.5 PHONE PROFILE	59
9.6 GPS	60
9.7 INTERNET SHARING	61
CHAPTER 10: CAMERA	63
10.1 OVERVIEW	63
10.2 TAKING A PICTURE	64
10.3 TAKING A VIDEO.....	64
10.4 SETTINGS AND OPTIONS.....	64
10.5 PICTURES AND VIDEOS	65
APPENDIX	66
A.1 SPECIFICATIONS	66
A.2 REGULATORY NOTICES	68

Chapter 1: Overview

1.1 Introduction

Hardware Overview

1	Volume up Press to turn up the volume; Press and hold for maximum volume.
2	Record * Press to record a voice note.
3	Volume down Press to turn down the volume; Press and hold to turn the ringer off.
4	MicroSD Card Slot
5	Power slider Slide the button to the right and hold to turn on; slide the button to the left to lock, slide the button to the right to turn off the back light.
6	2.5mm Headphone TV out
7	Stylus
8	Forward facing camera Use this camera for video calling.
9	Telephone receiver Speaker for listening to phone calls.
10	Indication LED Indicates notification/battery/GSM status. The blue light flashes when notifications exist for messages, missed calls or reminders. LED displays solid red or green light when the battery is under charge or the battery is fully charged. Green light flashes when GSM/UMTS is on.
11	Touch screen 2.46-inch TFT LCD touch screen display.
12	SEND Press to activate the dialer and to initiate a call.
13	Start Press to pull down the start menu.
14	Jog ball Scroll up, down, left or right to navigate; press to select.
15	OK Press to make a selection.
16	END Press to end a call; press and hold to return to the Today screen.
17	QWERTY keypad
18	Microphone
19	Mini-USB Cable Connector
20	Back cover lock
21	Velocity Button Press to launch Velocity toolbar. Press and hold to activate the launcher.
22	OK (side key) Press to make a selection.
23	Camera Button* Press and hold to launch the camera.
24	Reset Using the stylus, press to soft reset the device. Be sure to switch the device into sleep mode before resetting the device, otherwise unsaved data or settings may be lost.
25	Speaker

26	Main camera
27	Back cover

* These buttons are configurable. To assign new programs/functions, select **Start**→**Settings**→**Buttons**.

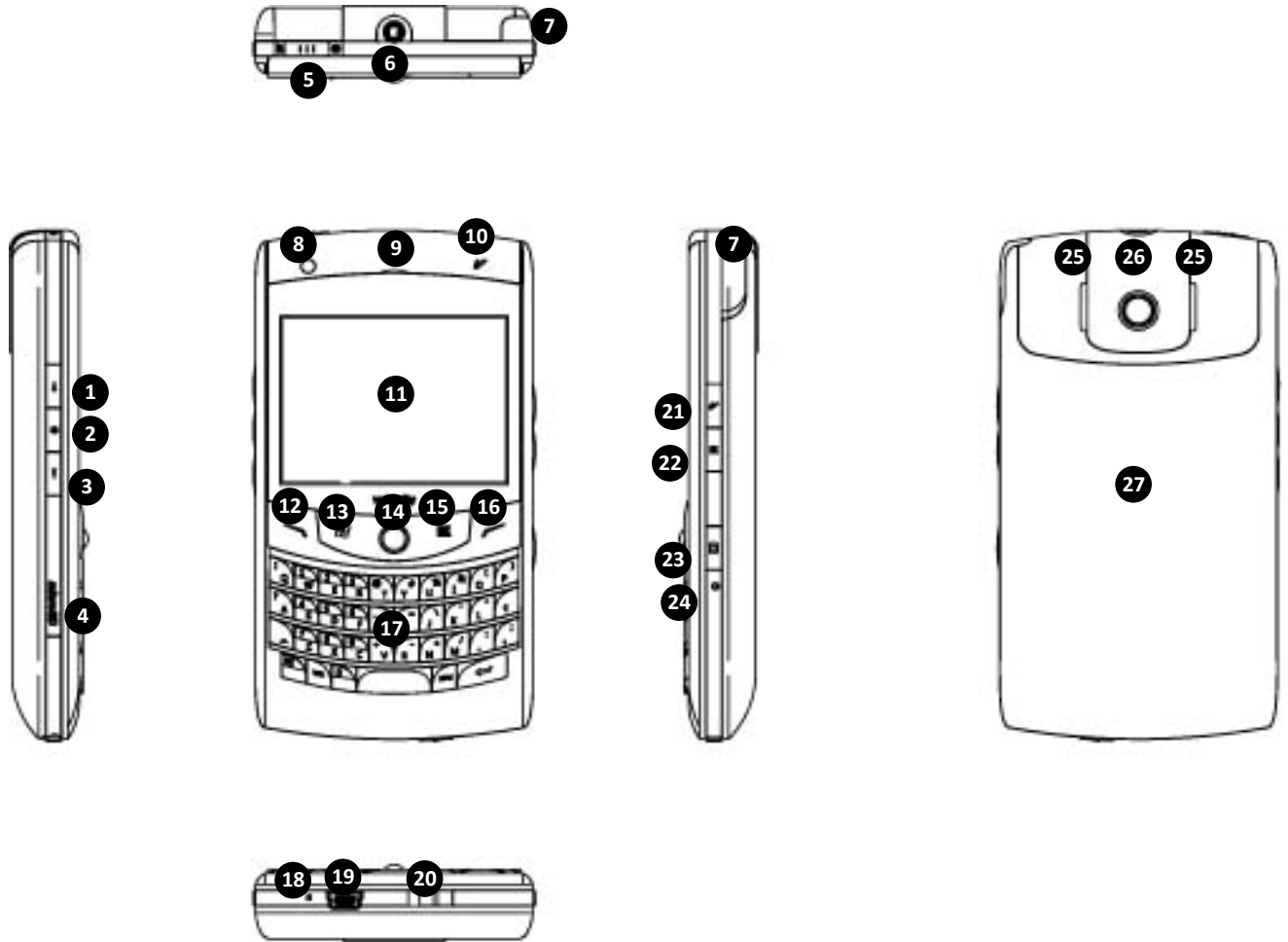

1.2 Introduction cont.

What's in the box



AC Adapter



Stereo Headset



USB Cable



Video Out Cable



Protective Pouch



Battery



UK Plug



EU Plug



Extra Stylus

1.3 Installing SIM Card, Battery and Micro SD Card

Installing the SIM Card and Battery

If you want to use the telephone features of the device, you must install a valid SIM card.

Unlock and remove the battery cover.

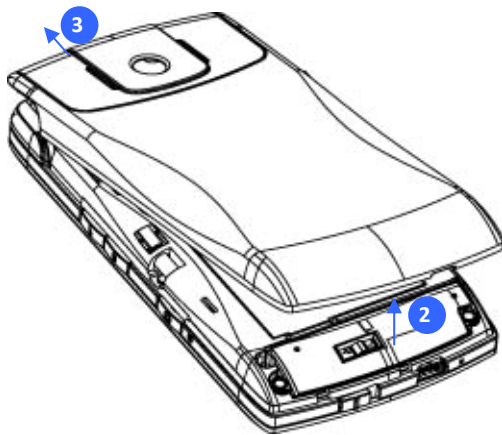

Place the SIM card with the gold contact facing down.

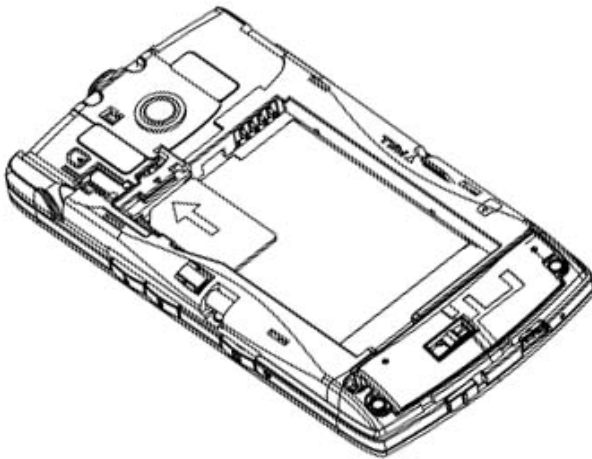

NOTE: When removing the SIM card, pull out the tray which fixes the SIM card, and then remove the SIM card from the tray.

Reinsert the battery. Push the opposite end of the battery until it snaps into place.

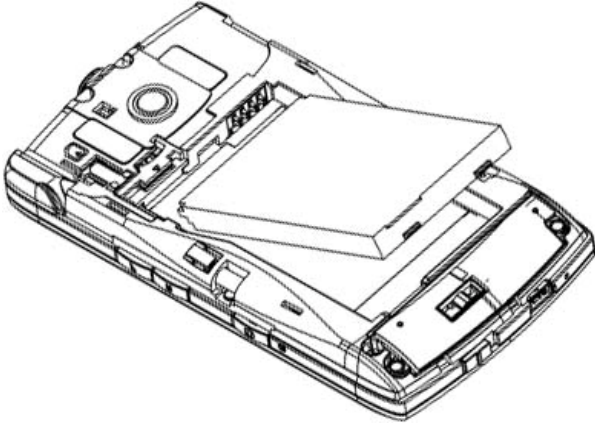

Replace the back cover. Press the back cover until it snaps into place.

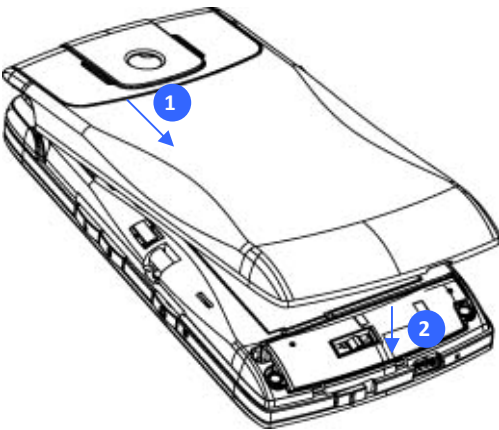

NOTE: The device is supplied with a rechargeable Li-ion polymer battery. This battery is supplied completely discharged and should be charged for at least 8 hours before first use. Please follow the normal turn-off procedure to remove the battery; otherwise unsaved data may be lost.

Installing a MicroSD Card

Use a certified MicroSD card in this slot to expand the device's storage memory (SDHC supported). To install the MicroSD card, do the following:

1. Unlock and remove the back cover.
2. Remove the media card slot cover.

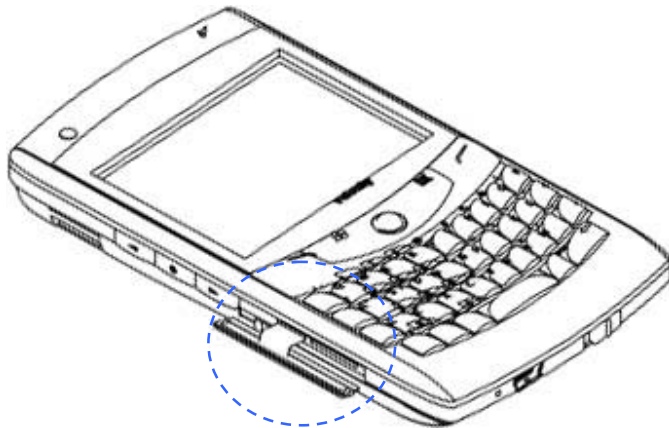

3. Insert the media card into the slot logo side up.

To remove the MicroSD card, gently press in on the card to eject.

NOTE: Inserting the MicroSD card in the wrong direction by force can cause damage to the card and the card slot.

1.4 Battery Information

Battery performance depends on many factors, including your wireless service provider's network configuration, signal strength, the temperature of the environment in which you operate your phone, the features and settings you select and use, items attached to your phone's connecting ports, and your voice, data, and other program usage patterns.

Battery life estimates (approximations subject to network conditions):

- Talk time(GSM): 4 hours
- Standby time(GSM): 200 hours

Charge Time (average):

- Charge by AC adaptor: 3 hours
- Charge by USB bus: 5 hours

Reducing Risk of Fire or Burns

- Do not attempt to open, disassemble or service the battery pack.
- Do not crush or puncture the battery, short the external contacts or dispose of in fire or water.
- Do not expose to temperatures above 45°C (113°F) or below -10°C (14°F).
- Replace only with the battery pack designated for this product.
- Recycle or dispose of used batteries as stipulated by local regulation and in a manner that respects the environment.

Checking the Battery Power

Select **Start**→**Settings**→**System tab**→**Power**.

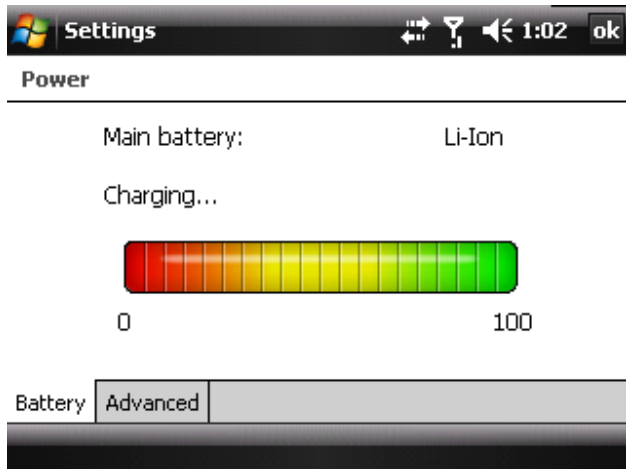

Optimizing Power Performance

Select **Start**→**Settings**→ **System** tab→**Power**→**Advanced** and then adjust settings.

Managing a Low Battery

When the low-battery warning appears, do the following:

1. Turn off Bluetooth and/or WiFi if they are currently enabled.
2. Immediately save your current data.
3. Plug in or turn off the device.

Charging the Battery

1. To charge the battery, make sure the battery is sitting in the battery slot correctly.
2. Do one of the following:
 - Connect the device to the AC adapter and plug the AC adapter into a power outlet.
 - Connect the device to a PC with the USB cable (supplied with the device).

NOTE: To charge the device with the USB cable, you must connect the device to a functioning USB port on a PC that is powered on.

IMPORTANT: For safety reasons, charging will not occur at temperatures below 0°C/32°F or above 40°C/104°F.

Chapter 2: Basic Operations

2.1 Getting Started

Turning On/Off the Device

- a) When the device is off: push the power slider at the top of the device to the right to turn on the device.
- b) When the device is turned on: push the power slider to the right to switch the device into sleep mode. You can still receive phone calls and messages when the device is in sleep mode.
- c) When the device is in sleep mode: push the power slider to the right.
- d) To power off the device completely, push the power slider to the right and hold for 3 seconds and the system will ask you to confirm before powering off the device.

Calibrating the device

Calibrating the device ensures that the system will respond to your on-screen touch interactions in the correctly. When you turn on the device for the first of time, you will be asked to calibrate the device. If you would like to re-calibrate the device, follow the steps below:

1. Select **Start**→**Settings**→**System** tab→**Screen**.
2. Select the **Align Screen** button and follow the on-screen instructions.

2.2 Today Screen





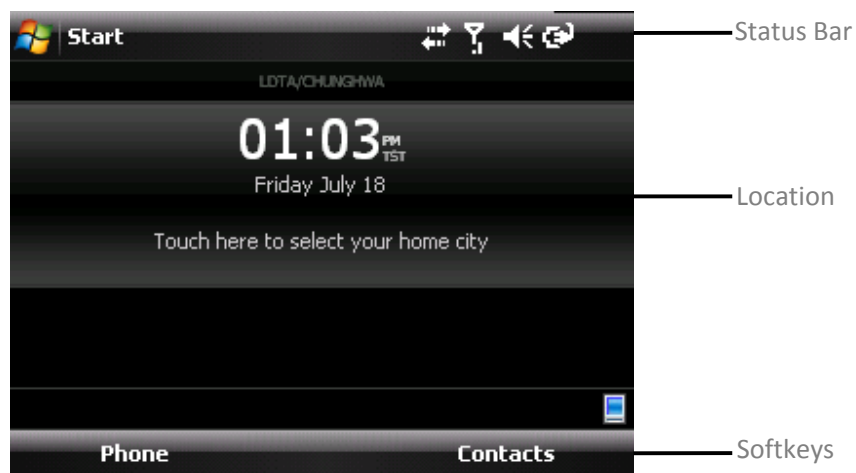

































Today Screen

The Today screen is your home screen. It displays system status and shows you the time and weather in the city that you select.



NOTE: You can access the Today screen by bringing up the Velocity toolbar and selecting the Today icon, or by selecting **Start**→**Today** or by pressing the END button.

Status Bar Notification Icons

	New e-mail		Roaming
	New Text (SMS) or Multimedia (MMS) message		Bluetooth headset detected
	New Voicemail message		Ringer on
	New notifications		Ringer off
	New instant message		Ringer in vibration mode
	Voice call		HSPA available
	Voice call in progress		HSPA in use
	Calls are being forwarded		GPRS available
	Call on hold		GPRS in use
	Missed call		EDGE available
	Battery full		EDGE in use
	Low battery		No SIM card installed
	Battery alert		Bluetooth connection in progress
	Extremely low battery		Wi-Fi connection in progress
	Battery charging		Data Connection is active
	Signal strength		Connection is not active
	No signal		Synchronization in progress
	Flight mode		Synchronization error
	No service		Alarm

Location

Location allows you to see the time and weather in cities that are important to you right from your home screen.

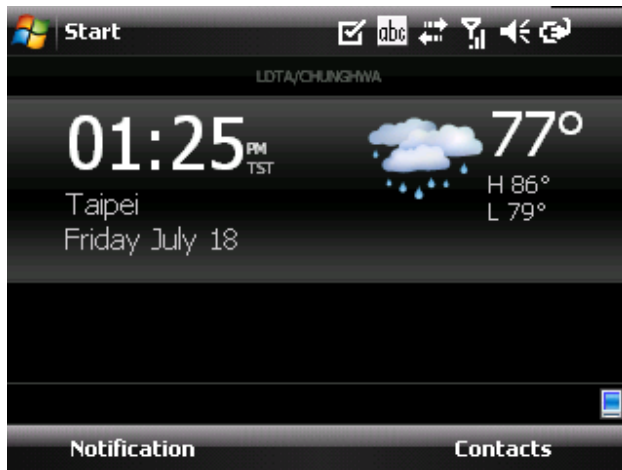

Adding Locations

You can add locations through the location settings. To access the location settings, press and hold on the location information panel on your home screen. Select **Add a City**, you can then enter a city directly or locate nearby cities via GPS.

Switching Locations

If you have more than one location, you can switch the location by sliding your finger left or right on the location panel.

2.3 VOTA (Velocity Over the Air)

VOTA (Velocity Over the Air) is an over-the-air updates system that uses your devices data connection to download and install software upgrades and new features. VOTA will automatically install the necessary files and clean up the installation files at the end of the update process.

Installing a VOTA (Velocity Over the Air) Update

1. A message will appear informing you that a VOTA update is available. Select **Install**.
2. For verification, select **Install** to continue.
3. VOTA will begin downloading the installation files.
4. VOTA will begin the install after the installation files have been downloaded.
5. VOTA will clean up the installation files after the install is complete.
6. The installation is now complete. Select **Close** to exit.

2.4 Velocity Toolbar

The Velocity toolbar allows you to:

- Create a customized, quick access tool to applications you prefer.
- Close open applications.

To launch the toolbar, press the Velocity button on the side of the device or swipe your fingertip from the Velocity logo below the screen toward the middle of the screen.





To customize the toolbar, press and hold the Velocity button to show all applications first. Press and hold a program icon and then drag it in order to add/remove it to/from the toolbar.

2.5 Start Menu

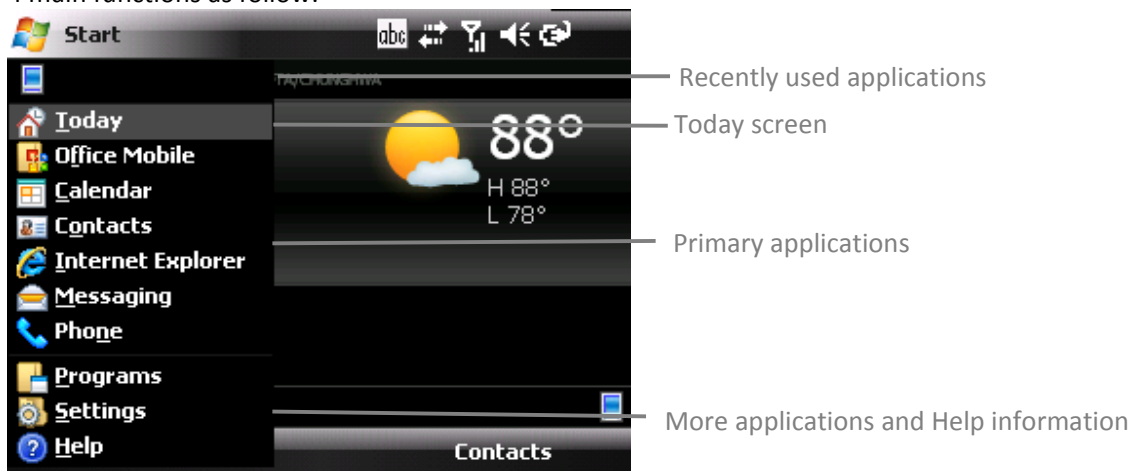
The Start menu is accessible by selecting the Start button at the top left of the screen and is divided into 4 main functions as follow:











2.6 Programs, Settings and Icons



















Programs		
	Games	Two games are installed on the device: Bubble Breaker and Solitaire.
	ActiveSync	Synchronize information between the device and a PC or Exchange Server.
	Auto Config	Select your mobile operator manually and automatically apply the correct data settings for that operator.
	Calculator	Perform basic calculations such as addition, subtraction, multiplication and division.
	File Explorer	Organize and manage the files and folders on the device.
	Getting Started	Brief introductions and shortcuts of common used items.
	Internet Sharing	Use the device as an external modem for a PC, connecting through a USB port or Bluetooth.
	JETCET PDF 5	View PDFs on the device.
	Messenger	Send and receive instant messages with your Windows Live Messenger contacts.
	MIDlet Manager	Install Java applications from local files or a network.
	Modem Link	Share the device connection with a PC or laptop.
	Notes	Take notes on the device.
	Phone Profile	Create and set profiles.
	Pictures & Videos	Organize and share pictures and videos.
	Remote Desktop Mobile	Create a connection between the devices and a Window Terminal Server.
	Search	Search the device.
	SIM Manager	Lets you manage your SIM card. See “5.5 Using SIM Manager” for details.
	Sim Toolkit	A software toolkit that comes with the SIM card. The functionality of this toolkit depends on your SIM card provider.
	Task Manager	Manage currently running programs.
	Tasks	Create, edit and synchronize tasks.
	Unit Converter	Convert commonly used measurements.
	VCamera	Take pictures and videos.
	Windows Live	Access Spaces, Instant Messenger and Windows Live services.
	Windows Media	Play music and video.
	Wireless Manager	Turn on/off wireless, Bluetooth and phone features.

Settings









Personal

	Buttons	Configure button actions.
	Input	Configure input methods.
	Lock	Set a password to unlock the device.
	Menus	Configure the Start menu.
	Owner Information	Enter and edit owner information.
	Phone	Configure the Phone features.
	Sounds & Notifications	Configure program and event sounds.
	Today	Configure the Today screen items and theme, including the background wall-paper and device color-scheme.

System



	About	Windows Mobile information and device name.
	Backlight	Configure the display backlight and adjust the brightness of display and keypad.
	Certificates	Manage personal and root certificates.
	Clock & Alarms	Set time and alarms.
	Customer Feedback	Send volunteered, non-personal information about how you use Windows Mobile software to Microsoft.
	Device Information	Display information about device system, software and hardware.
	Encryption	Encrypt files as they are placed on a storage card.
	Error Reporting	Enable or disables the in-built error reporting system.
	External GPS	Let you define the ports used for GPS configuration.
	Factory Reset	Reset all settings to the manufacturer defaults.
	Managed Programs	List programs that have been installed remotely by your system administrator.
	Memory	Check available device memory and memory card information.
	Power	Power management settings.
	Regional Settings	Configure the device's locale.
	Remove Programs	Allow you to view and remove installed applications.
	Screen	Let you align the screen. See "Calibrating the device" in Chapter 2 for details.
	Task Manager	Help you to manage currently running programs.
	TV-OUT Config	Select your TV output type here.
	Windows Update	Let you download Windows Mobile updates such as critical security fixes.

Connections





	Beam	Turn on/off the beam feature.
	Bluetooth	Configure Bluetooth settings. See “8.3 Using Bluetooth” for details.
	Connections	Configure the device’s connections.
	Domain Enroll	Allow you to connect the device with company resources.
	Network Cards	Configure the network adapter. When connecting to Wi-Fi, you can configure wireless networks here as well.
	USB Connection	You can set your device to synchronize with a PC or function as a card reader when it is connected to your PC through the USB port.
	Wi-Fi Network	Display detailed information for a connected Wi-Fi Network. You can change Wi-Fi Network settings here as well.
	Wireless Manager	Turn on/off wireless, Bluetooth and phone features.

2.7 Input Methods

The device contains 4 software input methods: keyboard, Letter Recognizer, Block Recognizer and Transcriber.

	Keyboard
	Letter/Block Recognizer
	Transcriber

Keyboard

1. Select the keyboard icon  in the center of the bottom menu bar to launch the keyboard. If the keyboard is not the selected input method, select the arrow next to the keyboard icon and select **Keyboard**.
2. Select the keys on the on-screen keyboard to enter text or do any of the following:
 - Select  on the on-screen keyboard to enter capital letters.
 - Select  on the on-screen keyboard to enter accented letters.
 - Select  on the on-screen keyboard to enter symbols and numbers.



Letter Recognizer

Letter Recognizer recognizes one letter, number or symbol at a time.

- To launch Letter Recognizer, select the input method selector arrow (the upward arrow next to the input method icon) and select **Letter Recognizer**.
- Write uppercase letters in the left recognition area (the ABC box).
- Write lowercase letters in the middle recognition area (the abc box).
- Write numbers and symbols in the right recognition area (the 123 box).

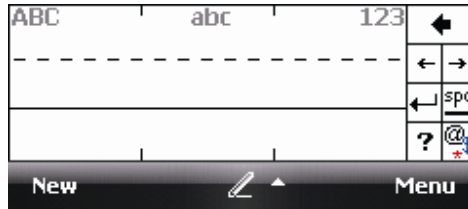

Block Recognizer

Block Recognizer recognizes letters written in one stroke.

- To launch Block Recognizer, select the input method selector arrow (the upward arrow next to the input method icon) and select **Block Recognizer**.
- Write lowercase letters in the text recognition area (the abc box on the left).
- Write numbers and symbols in the numeric recognition area (the 123 box on the right).
- To input symbols, select any recognition area, text or numeric, once and write symbols.



NOTE: Select ? in Letter or Block Recognizer to see a demo on how to write recognizable characters.

Transcriber

Transcriber recognizes handwriting in cursive and/or print. It uses the full screen as its recognition area. It interprets the movement of the stylus on the screen as you write.

- To launch Transcriber, select the input method selector arrow (the up arrow next to the input method icon) and select **Transcriber**.
- Write anywhere on the screen.



NOTE: The Transcriber comes with detailed help pages. Select  if you need further assistance.

Hardware Keyboard

Other than the on-screen keyboard, this device is equipped with a QWERTY keyboard. Please see below for tips of using the QWERTY keypad.

- (1) Press this key once (**Abc**), the first letter you enter will be capitalized.
 - (2) Pressing this key twice (**ABC**), all letters you enter will be capitalized.
 - (3) Hold down this key and press another key at the same time to enter capital letters constantly.
- In **Abc** mode, press this key again to enter lower case letters.

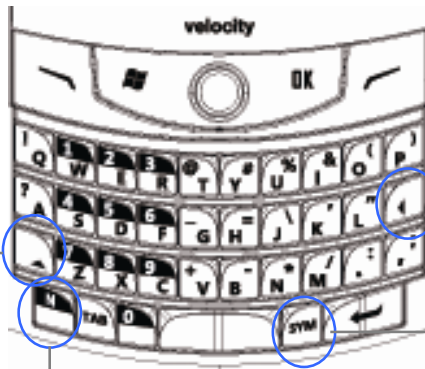

Press this key to erase the letter to the immediate left of the cursor. Press the "FN" key once and then press this key to delete the first letter on the right side of the cursor. To delete letters constantly, hold down the "FN" key and press this key at the same time.

You can input symbols and accented letters by using this key. After pressing a character, press the "SYM" key repeatedly, you can see all accent types of this character being displayed in sequence cyclically. Stop pressing the "SYM" key while the desired character shows. Please refer to the table below for corresponding symbols and accented letters for each character.

The "FN" key is used to access the symbols and numbers on the keypad. You can choose any of the three methods to input symbols/numbers:

- (1) Press the "FN" key once (**1~**), the next character you enter will be a symbol or number.
- (2) Press the "FN" key twice (**123**), you can then enter numbers and symbols constantly.
- (3) Hold down the "FN" key and press another key at the same time to enter its corresponding symbol.

To return to enter letters, press the "FN" key again in **123** mode.

Corresponding letters/symbols for each character:

a	à á â ã ä å æ ã ç ä	O	ò ó ô õ ö ø ø œ
A	À Á Â Ã Ä Å Æ Æ Å Æ	p	þ ƒ
c	ç ć ĉ ©	P	Þ Ƒ
C	Ç Ć Ć ©	r	®
d	đ	R	®
D	Ð	s	ß ş š
e	è é ê ë ě	S	ß Ş Š
E	È É Ê Ë Ě	t	ţ
i	ì í î ï ij	T	Ť
I	Ì Í Î Ï Ĳ	u	ù ú û ü ů ů μ
l	ł	U	Ù Ú Û Ü Ů Ů μ
L	Ł	y	ý
n	ñ	Y	Ý
N	Ñ	z	ź ż
o	ò ó ô õ ö ø ø œ	Z	Ź Ż

Chapter 3: Synchronizing Information

ActiveSync and Windows Mobile Device Center (WMDC) synchronize information on the device with information on your PC or Exchange server. ActiveSync works on computers that have the Windows XP Operating systems while WMCD works on computers that have Windows Vista.

Specifically, you can use ActiveSync or WMCD to:

- Synchronize Outlook e-mail, contacts, calendar or tasks on your phone with your PC.
- Synchronize pictures, video and music between the device and your PC.
- Synchronize Outlook e-mail, contacts, calendar appointments and tasks on your phone directly with Exchange Server.
- Copy files between your phone and your PC without synchronizing.
- Select which types of information are synchronized and specify how much information is synchronized. For example, you can choose how many weeks of past calendar appointments to synchronize.

3.1 Installing and Setting up ActiveSync

IMPORTANT: Be sure to install ActiveSync on the PC before connecting the device to it.

1. Install ActiveSync on your PC, as described on the Windows Mobile™ Getting Started Disc. After setup completes, the Synchronization Setup Wizard automatically starts when you connect the device to the PC (through a USB cable or Bluetooth).
2. Follow the instructions on the screen to complete the wizard. In the Sync Setup Wizard, you can:
 - Create a synchronization relationship between your PC and the device.
 - Configure an Exchange Server connection to synchronize directly with Exchange Server. To synchronize the device with Exchange Server, obtain the name of the Exchange Server, your user name, password and domain name from your administrator before completing the wizard.
 - Choose information types to synchronize.
3. Once synchronization completes, you can disconnect your phone from your PC.

3.2 Installing and Setting up WMDC

The Windows Vista operating system includes the basic WMDC application partially installed, you can fully install WMDC on your computer from the Getting Started Disc.

1. Follow the instruction on the Windows Mobile™ Getting Started Disc to install WMCD on your PC.
2. Connect the device to your PC, WMDC will start automatically.
3. Do either of the following on the home screen of WMDC:
 - Click **Set up your device** to select items that you want to synchronize. WMDC synchronizes the device automatically when you finish the set up.
 - Click **Connect without setting up your device** to transfer files, check updates or explore the device without synchronizing Outlook information.

3.3 Synchronizing Information

Starting and Stopping Synchronization Manually

1. On the device, select **Start**→**Programs**→**ActiveSync**.
2. To start synchronization, select **Sync**.
3. To stop synchronizing, select **Stop**.

IMPORTANT: You can start and stop synchronization only if the device already has a sync relationship with a PC or Exchange Server. Some Anti-Virus software may conflict with ActiveSync.

Changing Information is Synchronized

ActiveSync and WMDC synchronize a limited amount of information by default to save storage space on your phone. You can change the amount of information that is synchronized by performing the following steps.

1. On the Today screen, click **Start**→**Programs**→ **ActiveSync**.
2. Select **Menu**→**Options**.
3. Do one or more of the following:
 - Select the checkbox for the items you want to synchronize. If you cannot select a checkbox, you might have to clear the checkbox for the same information type elsewhere in the list.
 - Clear the checkbox for any items you want to exclude.
 - To customize synchronization of a computer, select the computer name and then click **Settings**.
 - To customize synchronization of particular information, select the information type and then click **Settings**.
 - To stop synchronizing with one computer completely, select the computer name and click **Delete**.

IMPORTANT: Outlook e-mail can be synchronized with only one computer and one Exchange ActiveSync server.

3.4 Changing Settings for an Information Type

IMPORTANT: Before changing settings for an information type on the device, disconnect the device from your PC.

1. Select **Start**→**Programs**→**ActiveSync**→**Menu**→**Options**.
2. Select one of the information types (e.g. E-mail, Tasks or Calendar items).
3. Do one of the following:
 - To view or change settings for an information type (when available), select **Settings**.
 - To view or change settings for a computer or Exchange Server, select **Settings**.
4. Change the amount of information to be synchronized or other settings.
5. Select **OK** (or **Finish** in the Exchange Server settings wizard).

3.5 Synchronizing with Exchange Server

To set up the device to synchronize directly with Exchange Server, you will need to get the name of the server and the server domain name from your service provider or system administrator. You must also know your Exchange user name and password.

1. On the device screen, select **Start**→**Programs**→**ActiveSync**→**Menu**→**Configure Server**. If you have not yet set up synchronization with Exchange Server, this menu item will say **Add Server Source**.
2. Enter your Email address and then tap **Next**.
3. Enter your user name, password, and domain name, then select **Next**. If you want the device to save your password so that you will not need to enter it on each connection, select the **Save password** checkbox.
4. In **Server address**, enter the name of the server running Exchange Server, then select **Next**. Select **This server requires an encrypted (SSL) connection** if you want to receive personal information more securely. However, if you select option this and your ISP does not support an SSL connection, you will be unable to receive e-mail.
5. Select the checkboxes for the types of information items that you want to synchronize with Exchange Server.
6. To change available synchronization settings, select the type of information and select **Settings**.
7. To change the rules for resolving synchronization conflicts, select **Menu**→**Advanced**.
8. Tap **Finish**.

NOTE: You can also use ActiveSync or WMDC to set up the device to synchronize remotely with the Exchange Server. The set up wizard is started when you connect the device to your PC after installing ActiveSync or WMCD on the PC.

3.6 Synchronizing via Bluetooth

Connecting to a PC Using Bluetooth

1. Your PC must be equipped with a suitable Bluetooth radio.
2. Follow the instructions in ActiveSync Help on the PC for configuring Bluetooth on your PC to support ActiveSync.
3. On the device, select **Start**→**Programs**→**ActiveSync**.
4. Select **Menu**→**Connect via Bluetooth**. Ensure that the device and PC are within close range.
5. If this is the first time you have connected to this PC via Bluetooth, you must complete the Bluetooth wizard on the phone and set up a Bluetooth partnership with the PC before synchronizing. This process will typically involve exchanging a pass-key between the device and the PC.
6. Select **Sync**.
7. When finished, select **Menu**→**Disconnect Bluetooth**.

NOTE: To preserve battery power, turn off Bluetooth after the synchronization is completed.

Chapter 4: Phone

4.1 Making a Call



The Phone Screen

From the phone screen, you can see dial records and Contacts and choose to make a video or voice call. To access the Phone Screen, do any of the following:

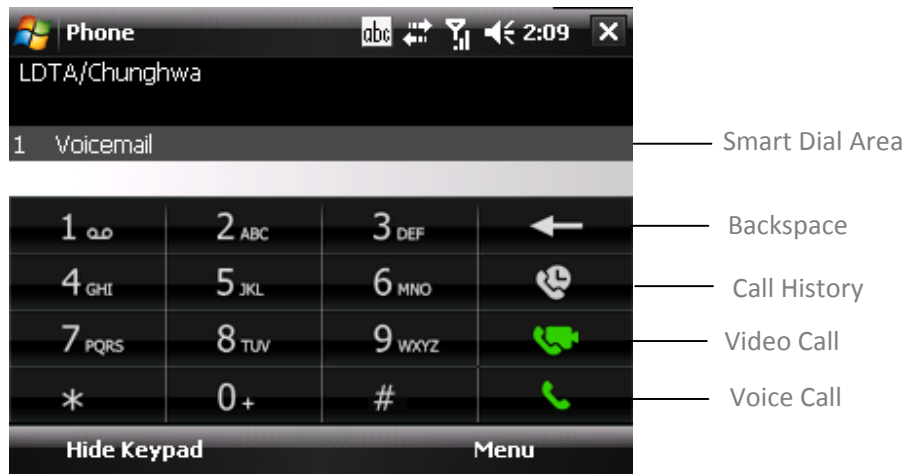
- Press the SEND hardware button.
- Select **Phone** on the Today screen.
- Select **Start → Phone**.



Making a Call by Using the Phone Keypad

1. On the Phone screen, select **Keypad** if the keypad is not displayed.
2. Enter the number to dial using the keypad.
3. Select matching contacts that come up in the smart dial area to dial that number and/or contact or finish entering the number and press  to make a voice call or  to make a video call.

Making a Call from Call History

1. On the Phone screen, select  to display call history full screen.
2. Scroll to the desired number or contact. Press TALK to make a voice call; select **Menu→Video call** to make a video call.

Making a Call from Contacts

Do either of the following to make a call from Contacts:

- **Voice Call.** On the Phone Screen, select **Hide Keypad** to show all Contacts on the smart dial area. Tap on the desired contact in the list and then tap on the number you want to dial.
- **Video Call.** Select **Contacts** on the Today screen, scroll to the desired contact, select **Menu→Video call**.

Making a Call from Speed Dial

You can create speed dial entries for frequently called numbers or frequently accessed items. Speed Dial allows you to dial a number by pressing a single key. For example, if you assign location 2 to a contact in Speed Dial, you can simply press and hold 2 on the Phone Keypad to dial the contact's number. Speed dials can be created only for numbers that are stored in Contacts.

On the Phone screen, do either of the following:

- Select **Menu→Speed Dial**. Scroll to the desired contact and press TALK to make a voice call; select **Menu→Video call** to make a video call.
- Select **Hide Keypad** to show speed dial entries on the smart dial area. Scroll to the number and then press TALK.

To create a speed dial entry for a contact

1. Tap **Contacts** on the Today screen.
2. Tap the contact for whom to create a speed dial.
3. Scroll to the phone number (if there is more than one) for which to create a speed dial.
4. Select **Menu→Add to Speed Dial**.
5. In **Location**, select the speed dial number to use.
6. Select **OK** when finished.

NOTE: The first speed dial location is generally reserved for your voice mail. Speed Dial uses the next available location by default. If you want to place a number in a location that is already used, the new number replaces the existing number.

To delete a speed dial entry

1. On the Phone screen, select **Hide Keypad**.
2. Select the entry that you want to delete.
3. Select **Delete**.

Receiving/Rejecting a Call

When you receive a phone call, you have the option to answer it or ignore it.

- To accept an incoming call, select **Answer** on the screen or press TALK to accept an incoming call.
- To hang up a call, select **Ignore** on the screen or press END.

NOTE: To adjust the earpiece volume during a call, press the volume up/down button on the phone side panel. Adjusting the volume at any other time to change sound levels for the phone ringer, system notifications and music.

You can mute the volume of incoming calls by pressing and holding the volume down button.

4.2 Configuring the Phone

Your wireless service provider may provide useful services such as Call Barring, Caller ID, Call Forwarding, Call Waiting, Voice Mail and Text Messages and Fixed Dialing. You can view and edit these settings from the Network.

Activating PIN Security

Most Subscriber Identity Module (SIM) cards are preset with a personal identification number (PIN) that is provided by your wireless service provider. When PIN Security is activated, you need to enter the PIN whenever you use your phone.

1. Select **Start**→**Settings**→**Phone**→**Require PIN when phone is used**.
2. Enter the preset PIN provided by your wireless service provider.
3. Select **Enter**.

NOTE: If your PIN is entered incorrectly three times, the SIM card will be blocked. If this happens, you can unblock it with the PIN Unlocking Key (PUK) obtained from your wireless service provider.

Changing the Ring Type and Ring Tone

You can choose how to be notified for incoming calls.

1. Select **Start**→**Settings**→**Phone**.
2. In the **Ring type** list, select the desired option.
3. In the **Ring tone** list, select the sound you want to use.
4. Select **OK**.

Changing the Ringer Volume

You can press volume up and down on the left side of the device to change the ringer volume or do the following:

1. Select the volume icon in the status bar on the screen.
2. Do one of the following:
 - Move the slider to the desired volume level.
 - Select **On**, **Vibrate** or **Off** to quickly change both the ringer and system and settings.

Blocking Incoming or Outgoing Calls

1. Select **Start**→**Settings**→**Phone**→**Services** tab.
2. Select **Call Barring**→**Get Settings**.

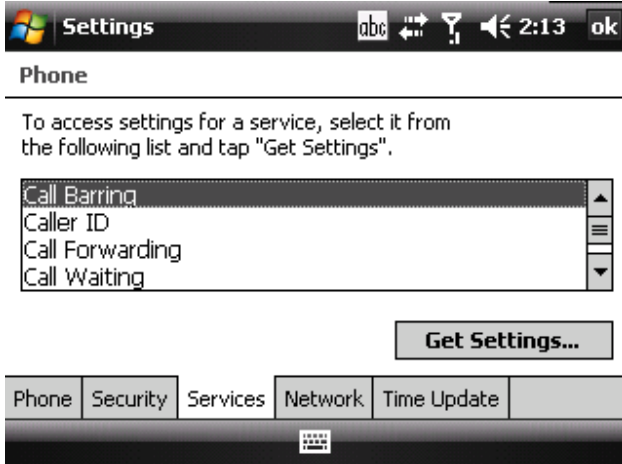

3. Choose the calls you want to block, and select **OK**.
 - Block incoming calls: All calls, When roaming, Off.
 - Block outgoing calls: All calls, International, International except to home country, Off.

Displaying Caller ID

You can provide a way for people to see your number when you are calling them.

1. Select **Start**→**Settings**→**Phone**→**Services** tab.
2. Select **Caller ID**→**Get Settings**.
3. Select **Everyone**, **No one** or **Only to contact**.

Call Waiting

When you are in another call, you will be notified of an incoming call if this option is selected.

1. Select **Start**→**Settings**→**Phone**→**Services** tab→ **Call Waiting**→**Get Settings**.
2. Select **Notify me** or **Do not notify me**, then select **OK**.

NOTE: Another way of changing phone settings is to select **Menu**→**Options**→**Services** from the Phone keypad.

Time Update

You can have the device update the time zone and clock automatically when it connects to a wireless service provider's network. (Not all service providers support this function, please contact your service provider for details.)

- Select **Start**→**Settings**→**Phone**→**Time Update** tab, then select **Update time zone and clock automatically (NITZ)**.

4.3 Voice Call In-Call Options

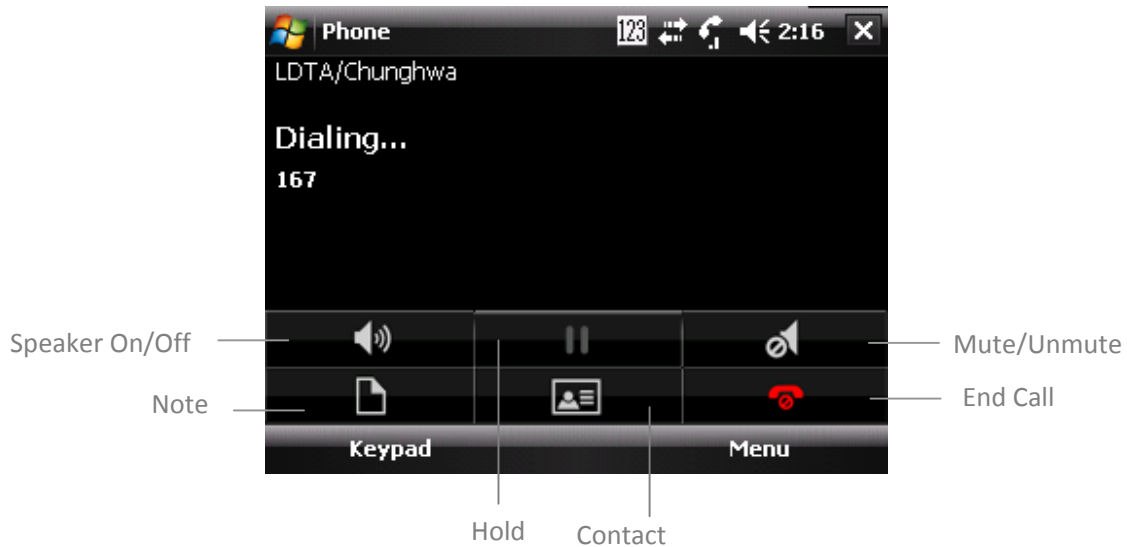

The device provides various options for managing multiple calls at the same time. You are notified when you have another incoming call, and you have the choice of ignoring or accepting the call. If you are already on a call and accept the new call, you can choose to switch between the two callers or set up a conference call between all three parties.



Answering a Second Call

1. Select **Answer** to take the second call and put the first call on hold.
2. To switch between two calls, tap **Menu**→**Swap**.
3. To end the second call and return to the first call, select  on the screen or press the END hardware button.

Conference Call

1. Either put a call on hold and dial a second number or accept a second incoming call when you have one in progress. (To dial a second number, tap  on the screen to put the first phone on hold and then tap  or **Keypad** to dial a second number.)
2. Tap **Menu**→**Conference**.
3. To end the second call and return to the first call, select  on the screen or press END.

NOTE: If the conference connection is successful, the word “conference” will appear at the top of the screen. Not all service providers support conferencing calling. Contact your service provider for details.

Muting the Microphone

The device’s microphone can be turned off during a call. If you turn off the microphone, the caller cannot hear you. However, you can still hear the caller.

- Select **Mute** during a call to turn the microphone off.





- Select **Unmute** to turn the microphone on.

4.4 Video Call In-Call Options

When in a video call, you can see yourself and the person you are talking to showing on the screen at the same time. During the call, you can choose to turn off the camera or switch between the forward facing camera and the main camera.



Changing Settings

- **Turn off camera.** The left window plays the local captured video from the camera on the device, to turn off this camera, select  on the screen. You can still see the captured video from the other side.
- **Switch camera.** To switch between the forward facing or main cameras, select  on the screen.
- **Switch Window.** To switch the size of preview window and remote window, select  on the screen.
- **Brightness.** Select  on the screen to adjust the brightness; there are four levels for brightness.
- **Night Mode.** During a call, select **Menu**→**Night Mode On/Off** to switch between night mode and normal mode.
- **Hands-free.** If you use Bluetooth headset, select **Menu**→**Turn Hands-free On/Off** to switch between speaker and headset.

Video Call Options

You can show a still image while turning off the camera and assign a ringtone for video call.

1. Select **Menu**→**Video Call Options** on the Phone screen.
2. In **Default video setting**, select the image that you want to display when you turn off the camera.

3. If you select **User define**, tap the text box under **File** to view available pictures and then select one.
4. In **Video call ringtone**, assign a ringtone in the drop-down list.

Chapter 5: Contacts & Messaging

5.1 Using Contacts

In Contacts you can store phone numbers, e-mail addresses, home addresses and any other information that relates to a contact (such as a birthday or an anniversary date). You can also add a picture or assign a specific ring tone to a contact.

You can quickly communicate with people using the contact list. Click a contact in the list for a summary of contact information and available communication methods. This summary page will allow you to call or send a message, depending on the information available for that contact.

If you use Outlook on your PC, you can synchronize contacts between your phone and PC.

Creating a New Contact

1. Do any of the following:
 - Select **Start→Contacts→New**.
 - Select **Contacts** on the Today screen **New**.
2. Select **Outlook Contact**.
3. Enter information for the new contact.
4. Select **OK**.

NOTE: If someone who isn't in your list of contacts calls you or sends you a message, you can create a contact from Call History or from the message by selecting **Menu→Save to Contacts**.

To save an existing contact to your SIM card, open the contact, select **Menu→Save to SIM**.

Viewing and Editing Contact Information

1. Select **Start→Contacts** or select **Contacts** on the Today screen.
2. Select the contact whose information you want to view.
3. To edit the information, select **Menu→Edit**.
4. Do any of the following:
 - Select **Picture** and select a picture you want to add. This can be an existing picture, or you can take a new picture using the camera program.
 - Select **Ring Tone** and select the ring tone you want to use for this contact. This will allow you to know who is calling without having to look at the screen.
 - Select **Categories** and select one of the options or create a new category.
5. When finished making changes, select **OK**.

Sending an E-mail to a Contact

1. Select **Start→Contacts** on the Today screen.
2. Select the contact from the list.
3. Select the e-mail account to use.
4. Enter a subject, compose your message, then select **Send**.

Sending a Text Message to a Contact

1. Select **Start**→**Contacts** or select **Contacts** on the Today screen.
2. Select the contact you want to send a text message to, then select **Send text message**.
3. Compose your message then press **Send**.

Creating a SIM Contact

Contacts can be created and stored on a subscriber identity module (SIM). If you move the SIM to another phone, your SIM contacts are moved as well.

1. Select **Start**→**Contacts**→**New**. Alternatively, select **Contacts** on the Today screen and then select **New**.
2. Select **SIM Contact**.
3. Enter the name and phone number of the contact then select **OK**.

5.2 Text Messaging

Creating a Text Message

1. Select **Start**→**Messaging**→**Text Messages**.
2. Select **Menu**→**New**.
3. Enter the recipient's text message number in the **To** field. Insert a semicolon (;) between multiple text message numbers.
4. Enter your message and select **Send**. Depending on phone signal, text messages will be sent immediately.

NOTE: You can quickly enter text message numbers from your contact cards. In the **To** field, press ENTER and select a recipient from the list. Then select the recipient's phone number. You can request a delivery notification for the text message. Select **Menu**→**Message Options**→**Request message delivery notification**.

Using Preset Text Messages

You can quickly insert preset or frequently used messages into your text message. While composing a message, select **Menu**→**My Text** and then add a preset message to insert.

Reading a Text Message

1. Select **Start**→**Messaging**→**Text Messages**.
2. Select **Inbox** ▼, then select Inbox under Text Messages.

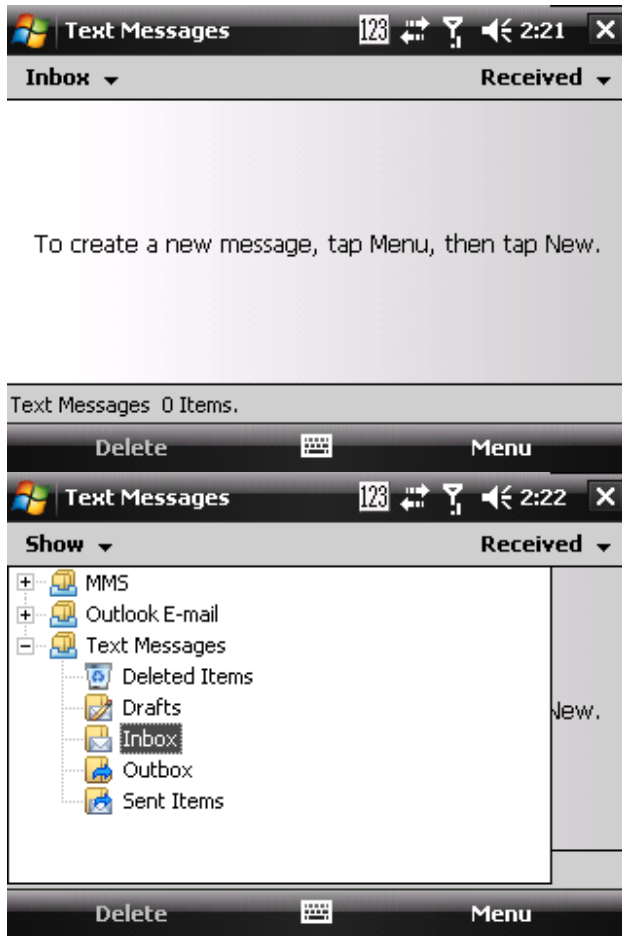

3. In the message list, select the text message you want to read.



5.3 Multimedia Messaging Service

Creating and sending Multimedia Message Service (MMS) messages to your friends and family is fun and easy. You can include text as well as existing or newly captured photos, video clips or audio before sending your MMS.

MMS messages can be broken up into various slides, where each of the slides can be any combination of audio or video clip, an image and/or text.

Composing a MMS Message

1. Select **Start**→**Messaging**→**MMS**.
2. Select **Menu**→**New**.
3. Enter the recipient addresses in the **To**, **Cc**, and/or **Bcc** fields. Insert a semicolon between multiple addresses.
4. In **Subject**, enter a subject.
5. To create a slide, do any combination of the following:
 - Select **Insert Picture/Video** and select a picture or video clip (or snap or record a new one).

- Select **Insert Audio** and select an audio clip.
 - Select **Insert Text** and enter a message.
 - Select **Menu→Insert→Sound Recorder**, then select the RECORD button () to record a new audio clip. Select STOP () button to stop recording.
 - Select **Menu→Options→Background Color**, select a background color for the slide.
6. Select **Send**.

NOTE: After the first slide is filled with content, you can select **Menu→Slides→Insert** to add another slide to your MMS message.

Previewing a MMS Message

You can preview an MMS message before sending it.

1. To preview your MMS message after composing it but before sending it, select **Menu→Preview**.
2. Select **Done** or **Replay** to dismiss or repeat the preview.

Reading a MMS Message

1. Select **Start→Messaging**.
2. Make sure the folder drop-down list says **Inbox▼**. If it doesn't, select the folder drop-down list and select Inbox under MMS.
3. In the message list, select the MMS message you want to read.

Configuring MMS Settings

MMS settings are typically a combination of user preferences and network operator settings. You will need to consult your network operator for details on the MMS settings specific to the network.

1. Select **Start→Messaging→MMS**.
2. Select **Menu→MMS Settings**.
3. Select the type of options to change.
4. Select **OK**.

5.4 E-mail

Setting up an E-mail Account

Before you set up your Internet e-mail account, please ensure that you have the necessary information from your e-mail service provider. The kind of information you'll need to have ready is tabulated below. Use this as a check-list before proceeding with the account set-up.

Setting	Description
User name	Usually the first part of your e-mail address, which appears before the "at" sign (@). For some e-mail service providers, the full e-mail address is used as the user name.
Password	Choose a strong password. You will have the option to save your password, so that you do not need to enter it each time you connect to your e-mail server.
Domain	The domain name. This may not always be required.
Server type	The type of e-mail server that hosts your mailbox (POP3 or IMAP4).
Account name	A friendly name for this account (e.g. "My Webmail"). You must use a different name for each

	account that you set up.
Network	The type of network your e-mail server connects to (e.g. Work or The Internet).
Incoming mail server	The name of your e-mail server (POP3 or IMAP4).
Require SSL connection	Select this to ensure you always receive e-mail for this account using an SSL connection. This enables you to receive personal information more securely. Please note that if you select this and your ISP does not support an SSL connection, you will not be able to connect to receive e-mail.
Outgoing mail server	The name of your outgoing e-mail server (SMTP).
Outgoing server requires authentication	Your outgoing e-mail server (SMTP) may require authentication. Note: unless otherwise specified in the next section, your previously given user name and password will be used for authenticating against the outgoing e-mail server.
Outgoing server settings	Your outgoing e-mail server may require different authentication settings than your incoming e-mail server.
Use different user name for outgoing server	A checkbox that lets you enter separate settings for your outgoing e-mail server.
User name	Your user name for the outgoing e-mail server.
Password	Your password for the outgoing e-mail server.
Domain	The domain name of the outgoing e-mail server.
Require SSL connection (Outgoing mail server only)	A connection that enables you to send personal information more securely. Note that if you select this and your ISP does not support an SSL connection, you will not be able to send e-mail.

Now you are ready to set up your account:

1. Select **Start**→**Messaging**→**Setup E-mail**.
2. Enter your e-mail address and password. Select **Save password** if you want, or you can enter the password each time you send and receive e-mail. Then select **Next**.
3. Select **Next**. If the device is connected to the internet, the Auto Setup feature will attempt to retrieve settings for this e-mail account, saving you the effort of typing in all the required settings. If no matching settings are found (or if no internet connection exists), then you will need to enter each setting manually.
4. Enter the name you want to appear when you send messages, then select **Next**.
5. In **Automatic Send/Receive**, select a frequency for sending/receiving e-mail. Please note that data charges will probably be incurred if you send and receive e-mail outside of Wi-Fi or Bluetooth range. Select **Review all download settings** to change your e-mail settings; otherwise, select **Finish** to start downloading messages.

NOTE: To change options for an e-mail account, select **Start**→**Messaging**→**Menu**→**Options** and then select the type of options to change.

IMPORTANT: If you save your password and then lose your phone, someone finding your phone might be able to gain access to your e-mail.

Composing an E-mail Message

1. Select **Start**→**Messaging**.
2. Select an e-mail account to use.
3. Select **Menu**→**New**. This will bring up a new e-mail form.
4. Enter recipient e-mail addresses in the **To**, **Cc** and/or **Bcc** fields as necessary. Insert a semicolon (;) between multiple addresses.
5. In the **Subject** field, type in a subject.
6. Enter a message.

7. Select **Send**. E-mail messages are stored in Outbox and are sent to recipients the next time you synchronize or connect to your e-mail server and send and receive mail.

NOTE: You can quickly enter e-mail addresses from your contact cards. In the **To** field, press ENTER and select a recipient from the list. Then, select the recipient's e-mail address.

To change message settings such as its priority, select **Menu**→**Message Option** in the message you are editing. Select the type of options to change and then Select **OK**.

Reading an E-mail Message

1. Select **Start**→**Messaging**, select an e-mail account.
2. Make sure the folder drop-down menu says **Inbox**▼. If it doesn't, select the drop-down menu and select **Inbox** under this e-mail account.
3. In the e-mail list, select the e-mail message you want to read.

NOTE: Unread e-mails are normally listed in the Messaging item on the Today screen. You can access unread e-mails directly by selecting the Messaging item on the Today screen.

5.5 Using SIM Manager

The SIM Manager allows you to manage the phonebook in your SIM card. Using the SIM Manager, you can easily transfer phonebook entries from your SIM card to Contacts.

Adding a Phonebook Entry to the SIM Card

Please note that SIM card contacts can store far less information than Outlook contacts. There is a restriction on the length of the contact name, you can only have one number per contact.

1. Select **Start**→**Programs**→**SIM Manager**.
2. Select **New** and enter the name and phone number you want to add.
3. Select the **Add** button.

Deleting a Phonebook Entry from the SIM Card

1. Select **Start**→**Programs**→**SIM Manager**.
2. Select an entry you want to delete and tap **Menu**→**Delete**.
3. Select **Yes** to confirm that you want to delete the contact.

Saving Phonebook Entries to Contacts

1. Select **Start**→**Programs**→**SIM Manager**.
2. Select the entries that you want to save to Contacts by checking the checkboxes in front. Select **Menu**→**Check All** if you want to select all entries.
3. Select **Menu**→**Save to Contacts**.
4. Select **OK** to close the notification dialog box.

Saving Contacts to SIM Card

1. Select **Start→Programs→SIM Manager**.
2. Select **Menu→Contacts to SIM**.
3. Select the phone type(s) from the Outlook Contacts and then select **OK**.
4. Select the contacts you want to save to SIM card by checking the checkboxes in front. Select **Menu→Check All** if you want to select all contacts.
5. Select **Save**.

NOTE: One SIM card entry can only store one phone number, if you select more than one phone type from the Outlook Contacts (e.g. Work tel and Mobile tel), SIM Manager will create different entries separately for the same contact and mark the entries with a phone type abbreviation (e.g. Chris/WT and Chris/MT).

Chapter 6: Basic Applications

6.1 Using Calendar

Use the Calendar application to schedule appointments, including meetings and other events. Your appointments for the day can be displayed on the Today screen. If you use Outlook on your PC, you can synchronize appointments between the device and PC. You can also set Calendar to remind you of appointments with an audible alarm or flashing light.

You can look at your appointments in several different views (Day, Week, Month, Year and Agenda). To see detailed appointment information in any view, select the appointment.

Making an Appointment

1. Select **Start**→**Calendar**. Alternatively, you can select the appointment item on the Today Screen.
2. Select **Menu**→**New Appointment**.
3. Enter information about the appointment.
4. Select **OK** to save the appointment.

NOTE: If you make this appointment as an all-day event, it will not occupy blocks of time in Calendar; instead, it will appear in banners at the top of the Calendar view.

You can assign a category to an appointment or create a new category for it.

Deleting an Appointment





1. Select **Start**→**Calendar**.
2. In Agenda/Day/Week view, select the appointment to delete.
3. Select **Menu**→**Delete Appointment**.
4. If the appointment is recurring, select **All** to delete the series or select **One** to delete only the current occurrence.

NOTE: When you delete an appointment in Calendar on your phone, it is also deleted on your PC the next time you synchronize. If the appointment has not been synchronized with a PC, it will be deleted only from the phone.

Changing Calendar Views

You can look at your appointments in Agenda, Day, Week, Month or Year view. To see detailed appointment information in any view, select the appointment. To see a list of available actions for an appointment, select and hold the appointment.

1. Select **Start**→**Calendar**.
2. Select **Menu**→**View**, then select the view you want. You can view your calendar in the following layouts:
 - Today's agenda: your current day's activities at a glance. Upcoming appoints appear in bold text; past appointments are dimmed.

- Appointment for the week: your schedule for the whole week.
- Agenda for a specific date: your schedule for a single day in a day-planner layout. Free and busy period are shown in time slots of 1/2 hour or 1 hour.
- Appointment for the month: your free and booked days for a month.  indicates there is a morning appointment;  indicates there is a afternoon appointment;  indicates there are both morning and afternoon appointments;  indicates there is a all-day event.

NOTE: In Month view, a date will appear in red when the Holiday category is assigned to any appointment for that day.

You can also cycle through the views by selecting Agenda, Day, Week, Month or Year on the menu bar.

You can quickly see your appointments for the current day in Agenda view, select **Menu**→**Go to Today**.

Changing the Default Calendar Settings

1. Select **Start**→**Calendar**.
2. Select **Menu**→**Tools**→**Options** and then do one of the flowing:
 - In **Start in**, select the calendar view you prefer.
 - To specify the first day of the week, in **1st day of week**, select **Sunday** or **Monday**.
 - To specify the number of days you want to appear in a week, in **Week view**, select **5-day week**, **6-day week**, or **7-day week**.
3. Select **OK** to save settings.

6.2 Using Notes

The Notes program helps you to quickly capture thoughts, questions, reminders, to-do lists and meeting notes. You can create handwritten and typed notes, record voice notes, convert handwritten notes to text for easy readability and send notes to others.

Your notes and recordings are displayed in the note list. If you have a long list, select the sort list (labeled **Name** by default), and select the option you want. To open a note or play a recording, select it. To see a list of available actions for a note or recording, select and hold the note or recording.

Creating a Note

1. Select **Start**→**Programs**→**Notes**.
2. Select **New** and enter text.
3. Select **OK** to save your note.

Setting the Default Input Mode and Template for Notes

1. Select **Start**→**Programs**→**Notes**.
2. Select **Menu**→**Options**.
3. Select one of the following modes in **Default mode**:
 - Select **Writing** if you prefer your notes to be handwritten.
 - Select **Typing** if you would like your notes to be typed.

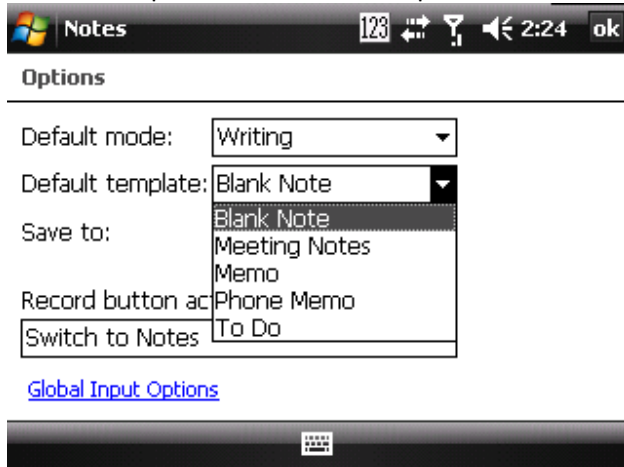

4. Select a template from Default template.



5. Select **OK** to save your settings.

NOTE: You can change the input mode when editing a note. Select **Menu**→**Draw** to switch to a different mode. A check mark next to **Draw** indicates that it is in writing mode.

Creating a Stand-alone Voice Recording

1. Select **Start**→**Programs**→**Notes**.
2. If the recording toolbar is not shown, select **Menu**→**View Recording Toolbar**.
3. Select the RECORD button  on the recording toolbar and speak into the microphone to start a voice recording.
4. Select the STOP button  on the recording toolbar when finished. The recording will appear in the notes list, and you can review it by selecting it.
5. Select **OK** to return to the notes list.

NOTE: Except creating a stand-alone voice recording, you can also add a voice recording to a note.

Editing a Handwritten Note

Two important options for editing a handwritten note are the Undo/Redo Ink items and the select All and Clear items:

- Undo/Redo Ink

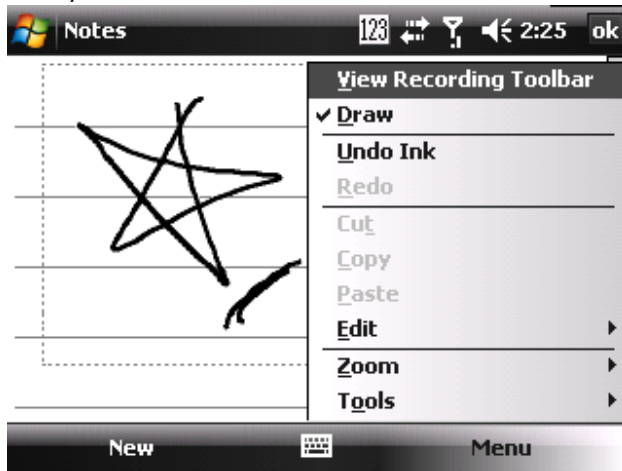

- Select All/Clear

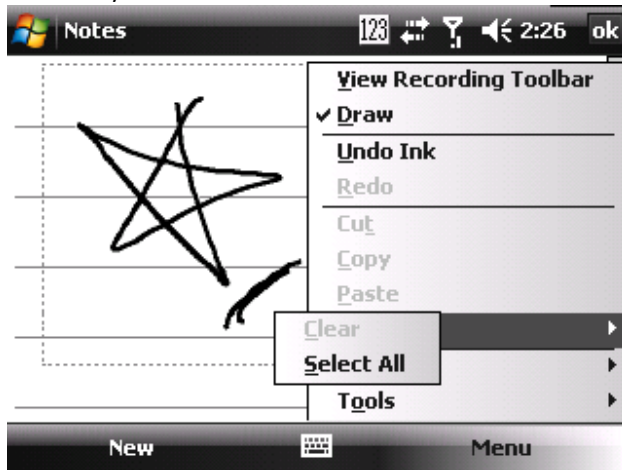

Deleting a Note

1. Select **Start**→**Programs**→**Notes**.
2. Select and hold the note then select the **Delete** command.
3. Select **Yes** to confirm deleting the selected note.

6.3 Using Tasks

Use Tasks to keep track of things you need to do. A task can occur once or repeatedly (recurring). You can set reminders for your tasks and you can organize them by using categories.

Your tasks are displayed in a task list. Overdue tasks are displayed in red.

If you use Outlook on your PC, you can synchronize tasks between the device and PC so that tasks you create or update on your PC will also be updated on the device and vice versa.

NOTE: To quickly see the number of active tasks you have, select **Start→Today**. If the Tasks item is enabled, you will see the number of active tasks listed on the Today screen.

Creating a Task

1. Select **Start→Programs→Tasks**.
2. Do one of the following:
 - Select the box labeled **select here to add a new task**, enter the task name and press the jog ball.
 - Select **Menu→New Task**, and then enter details about the new task.

NOTE: You can synchronize information on your phone with your PC to keep your task list up to date in both locations.

If you create a new task with a reminder on your PC and then synchronize tasks with your phone, the reminder will play at the time it was set on your PC.

You can assign a category to a task or create a new category for it. When editing a task, select **Categories→New** and then give the new category a name. Select **Done** and the new category will appear in the list.

Deleting a Task

1. Select **Start→Programs→Tasks**.
2. Select the task, select **Menu→Delete Task**.

Changing a Task

1. Select **Start→Programs→Tasks**.
2. Select an existing task and select **Edit**.
3. When finished making changes, select **OK**.

Sorting/Filtering Your Tasks

1. Select **Start→Programs→Tasks**.
2. Do one of the following:
 - To sort the tasks, select **Menu→Sort by**, then select a sorting option (e.g. Status or Due Date).
 - To filter the tasks by category, select **Menu→Filter**, then select a category to display.

Setting Tasks Options

1. Select **Start→Programs→Tasks**.
2. Select **Menu→Options**, there are 3 options you can set:
 - Set reminders for new items
 - Show start and due dates
 - Show Tasks entry bar

Chapter 7: Connecting to the Internet

7.1 Setting up Internet connections

The device's powerful networking capabilities allow you to access the Internet or your corporate network at work through telephony or wireless connections. Specifically, you can configure the device to establish a connection via GPRS/EDGE/HSPA, Dial-up and Wi-Fi, or set up a VPN or network Proxy.

With an active connection on the device, you can browse the Web, download e-mails or use Window Live Messenger. Check with your service provider to see if a connection has already been set up for you and if over-the-air configuration is supported.

If you need to manually set up a connection, it is important that you obtain the following information from your Internet Service Provider (ISP) or the company whose intranet you are trying to access:

- User name
- Password
- Access point name (required for GPRS connection)
- Domain name (required for accessing a corporate network or an intranet)

Creating a GPRS/EDGE/HSPA Connection

Every network connection is different. You should gather all of the relevant information or network settings you need before starting this process.

1. Select **Start**→**Settings**→**Connections** tab→**Connections**.
2. Select **Add a new modem connection**.
3. Enter a name for the connection.
4. In **select a modem**, select **Cellular Line (GPRS)**→**Next** to continue.

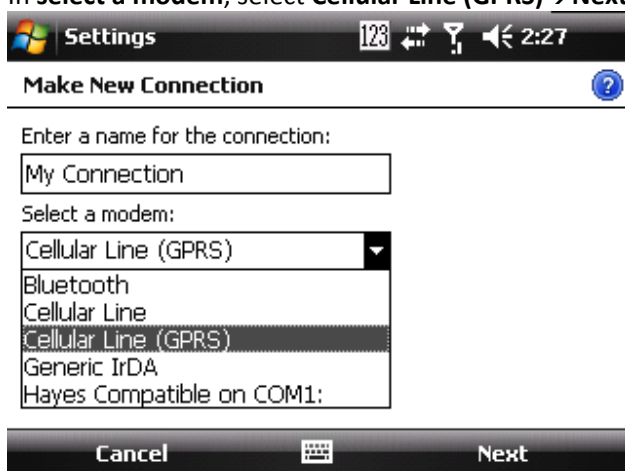

5. In **Access point name**, enter the access point name then select **Next**. Access point name will be provided by your carrier.
6. In **User name**, enter your user name for the GPRS network, if required.

7. In **Password**, enter a password, if required. This information is also provided by your network operator.

Settings abc 2:28

My Connection ?

User name:

Password:

Domain:*

* If provided by ISP or network

Advanced...

Back Finish

8. If required, select **Advanced** and enter information related to Servers and TCP/IP.
9. Select **Finish**.

NOTE: The device cannot connect to a PC through ActiveSync while connecting to the Internet using GPRS/EDGE/HSPA.

Creating a Dial-up Connection

No all service provider support dial-up connection, please consult with your service provider. You will need a phone number to connect to the Internet, a user name and a password in order to continue the following steps.

1. Select **Start**→**Settings**→**Connection** tab→**Connections**.
2. Under **My ISP**, select **Add a new modem connection**.
3. In **Enter a name for the connection**, enter a name for the connection.
4. In **Select a modem**, select **Cellular Line**→**Next**.
5. Enter the phone number provided by your service provider, select **Next**.
6. Enter the user name and password, select **Finish**.

Creating a Proxy Connection

Proxy connection lets you access the Internet through an intermediary IP address. You should gather all of the relevant information or network settings you need before starting this process.

1. Select **Start**→**Settings**→**Connections** tab→**Connections**.
2. Select **Set up my proxy server**.
3. Check the checkbox in front of **This network connects to the Internet**.
4. Check the checkbox in front of **This network uses a proxy server to connect to the Internet**.
5. Under **Proxy server**, enter the proxy server name.
6. If the proxy server uses a different port or requires a username and password, select **Advanced**, select the proxy type to change its settings, then enter username, password and/or port number in the proper fields.
7. Select **OK**.

Starting a Connection Manually

You can start a connection manually if there is more than one connection type set on the device.

1. Select **Start**→**Settings**→**Connections** tab→**Connections**.
2. Select **Manage existing connections**.
3. Select and hold the desired connection type, then tap **Connect**.

Deleting a Connection

1. Select **Start**→**Settings**→**Connections** tab→**Connections**.
2. Select **Manage existing connections** in the **My ISP** section.
3. Select and hold on the connection you want to delete, then select the **Delete** command.

7.2 Using a Wi-Fi Connection

Wi-Fi is wireless radio technology that allows you to access e-mail, the internet and broadband multimedia content. When the device encounters a hot-spot (a place where you can access Wi-Fi networks) it can then connect to that network wirelessly. While some hotspots are free, the most robust public Wi-Fi networks are provided by private internet service providers (ISPs) or wireless carriers, and using these networks will typically require payment of a connection fee.

NOTE: You may need to consult your ISP before running this utility.

IMPORTANT: The Wi-Fi connection is disabled when the device is synchronizing with a PC. The Wi-Fi connection and the GSM connection cannot exist at the same time. The GSM connection will be disabled automatically while having a Wi-Fi connection, and vice versa.

Connecting to a Wi-Fi Network

1. Select **Start**→**Settings**→**Connections** tab→**Wireless Manager**.
2. Select the third button to turn on Wi-Fi connection (unless it already says “On”).
3. Follow the prompts to finish related settings. When a Wi-Fi connection is activated, the  icon shows at the top of the screen.
4. If you want to switch to another Wi-Fi network, select **Start**→**Settings**→**Connections** tab→**Wi-Fi**. (The program “Network Cards” will change its name into “Wi-Fi” if the Wi-Fi network is connected successfully.)
5. On the **Wireless** tab, you can see the connected network and other available wireless networks.

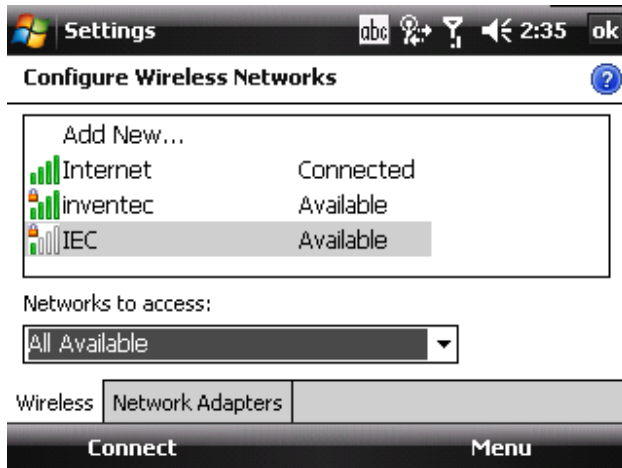

6. Select a wireless network then select **Connect**.
7. Follow the prompts to finish related settings.
8. Select **OK** to close the window.

Checking the Wi-Fi Connection

You can check the current wireless connection status after connecting to a Wi-Fi Network.

1. Select **Start** → **Settings** → **Connections** tab → **WiFi Network**.
2. Information such as the SSID (the Wi-Fi network name) and the wireless network signal strength will be shown in a summary screen.

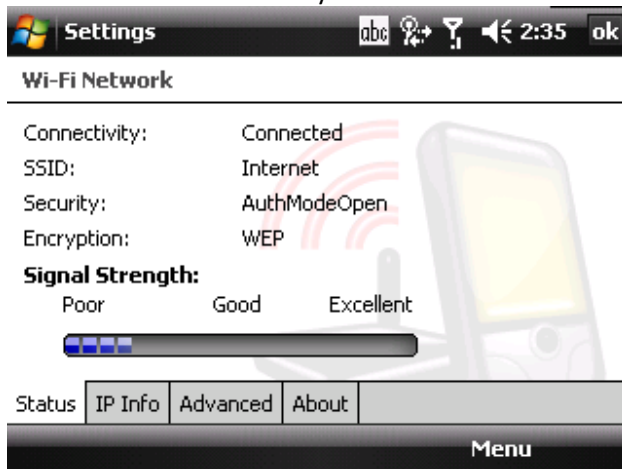

3. Select other tabs to check IP information, change power saving settings or review other advanced settings.
4. Select **OK**.

Configuring Wi-Fi Settings

You can configure wireless networks on the device by adding new Wi-Fi connections and editing currently available networks.

IMPORTANT: The screen for wireless networks configuration can only be accessed after Wi-Fi is turned on.

Creating a Wireless Connection

Some Wi-Fi networks are hidden. You might sometimes need to enter the network settings manually. To set up a new Wi-Fi network connection, you will first need to have your home router settings or information from your administrator about joining the corporate Wi-Fi network.

1. After turning on Wi-Fi on the device, do either of the following:
 - Open Wireless Manager, select **Menu**→**Wi-Fi Settings**.
 - Select **Start**→**Settings**→**Connections** tab→**Network Cards**.
2. On the **Wireless** tab→**Add New**.
3. Enter the Network name, select a Network type, then select **Next**. If you want to connect to another device instead of a network through an access point, select **This is a device-to-device (ad-hoc) connection**.
4. Enter required information, then select **Next**.
5. Select **Use IEEE 802.1 x network access control** to use EAP (Extensible Authentication Protocol). Select **EAP type: PEAP** or **Smart Card or Certificate**.
6. Select **Finish**.

Editing a Wireless Network

1. Open Wireless Manager and then select **Menu**→**Wi-Fi Settings**.
2. On the **Wireless** tab, you can see currently available wireless networks. Select and hold the network you want to edit, then select **Edit** on the pop-up menu.
3. Change the settings of this wireless network as required.
4. Select **Finish** to save your settings.

7.3 Using Wireless Manager

You can use Wireless Manager to activate and de-activate the various wireless features on the device, including cellular phone, Bluetooth and Wi-Fi. Wireless Manager is useful when you need to reduce battery consumption or if you use the device on an aircraft.

Opening Wireless Manager

To open the Wireless Manager, do one of the following:

- Select the signal strength icon (📶) at the top of the screen then select **Wireless Manager**.



- Select **Start**→**Settings**→**Connections** tab→**Wireless Manager**.

Enabling and Disabling a Wireless Feature

The Wireless Manager allows you to turn connections on and off quickly and easily.

1. Phone: turn the phone on and off.
2. Bluetooth: turn Bluetooth on and off.
3. Wifi: turn wifi on and off.
4. Flight mode: turn all off.



7.4 Using Internet Explorer Mobile

Internet Explorer Mobile is a full-featured Web browser, optimized for use on your phone. You can use Internet Explorer Mobile to browse the Internet once you have set up your Internet connection (if you haven't done so, please read the previous sections before continuing).

Browsing the Internet

1. To browse the Internet you must have a valid connection established.
2. Select **Start**→**Internet Explorer**.
3. Do either of the following:
 - Enter the address in the address bar, and Select .
 - Select **Favorites** then select a Web Page from the list.

Adding a Web Page to the Favorite List

1. Select **Start**→**Internet Explorer**.
2. To go to the page you want to add, select **Menu**→**Add to Favorites**.
3. Confirm or change the name and Web page address.
4. In **Create in**, select a folder for this favorite.
5. Select **Add**.

NOTE: A quick way to add favorites to your phone is to synchronize with your PC using ActiveSync. For more information, see ActiveSync Help on your PC.

Deleting a Favorite

1. Select **Start**→**Internet Explorer**.
2. Select **Favorites**.
3. On the **Add / Delete** tab, select the favorite to delete.
4. Select the **Delete** button.
5. Select **Yes** to confirm the deletion.

Changing the Size of Text on Web Pages

1. Select **Start**→**Internet Explorer**.
2. Select **Menu**→**View**→**Zoom Level**, then select the size you want.

Showing or Hiding Pictures on Web Pages

1. Select **Start**→**Internet Explorer**.
2. Select **Menu**→**View**→**Show Pictures**. Images on the Web pages that you visit will be download. Un-check this item if you do not want Internet Explorer to show pictures.

Changing Web Page Display Options

1. Select **Start**→**Internet Explorer**.
2. Select **Menu**→**View**, then select one of the following:
 1. **One Column**. Arranges the content into one column that is as wide as the screen. This means that you will rarely have to scroll horizontally.
 2. **Fit To Screen**. Maintains a layout similar to what you see on a desktop computer, but makes items smaller and arranges the content so that you can see most of it without having to scroll horizontally.
 3. **Desktop**. Keeps the same layout and size as on a desktop computer, which will require both horizontal and vertical scrolling.

Send a Link by E-mail

1. Select **Start**→**Internet Explorer**.
2. Go to the page you want to send.
3. Select **Menu**→**Tools**→**Send Link**.
4. The Messaging accounts list will appear. Select an account.
5. A new message will be created with the page address inserted in the message body. Choose a recipient, enter any accompanying message then select **Send**.

Clearing History, Cookies, or Temporary Files

From time to time you might want to clear up space on the device and wipe Internet Explorer's browser history.

1. Select **Start**→**Internet Explorer**.
2. Select **Menu**→**Tools**→**Options**.
3. Select the **Memory** tab.
4. Change the number in the day(s) box if needed.
5. Select **Clear History** or **Delete Files** then select **OK**.

Viewing a Page in Full Screen Mode

1. Select **Start**→**Internet Explorer**.
2. Select **Menu**→**View**→**Full Screen**.

NOTE: To exit full screen mode, select and hold on the screen and then un-check the **Full Screen** item in the pop-up menu to cancel the selection.

Chapter 8: Transferring Files To and From the device

You might need to transfer application data such as Word documents, Excel spreadsheets, PowerPoint slides and/or media files from your PC to the device, and vice versa. This section describes different methods for transferring files to and from the device.

8.1 Using ActiveSync

NOTE: To transfer files from PC to the device with ActiveSync, Windows XP users must first install Microsoft ActiveSync on the PC first. Windows Vista users do not need to install ActiveSync, but should use Windows Mobile Device Center, which comes pre-installed with Vista. Please refer to “Chapter 3. Synchronizing Information” for details on how to install and set up ActiveSync.

1. Connect the device to the PC with the USB cable. Microsoft ActiveSync on the PC should start up the Synchronization Setup Wizard automatically.
2. Select an information type under Synchronization Options in the Synchronization Setup Wizard by checking the appropriate checkbox.
3. Select the **Settings** button and add the files you want to transfer to the device. Select the **OK** button when you finish.
4. Select **Next**, then select **Finish** to start the synchronization process.
5. On the device, select **Start**→**Programs**→**File Explorer**. The newly transferred files should appear under **My Documents**. Check to see if the files have been transferred to the device successfully.

8.2 Transferring from Memory Cards

1. Insert your memory card into the device’s MicroSD card slot. (See “1.3 Installing SIM card, Battery and MicroSD card” for details.)
2. Select **Start**→**Programs**→**File Explorer**.
3. In the **Show** list, select **Storage Card**.
4. File Explorer should display all the files stored in your memory card. Select and hold the file or folder you want to transfer then select **Copy** from the pop-up menu.
5. From the **Show** list in File Explorer, choose the destination folder for the copied files. (For example, select **My Device**→**My Documents**.)
6. In the destination folder, select **Menu**→**Edit**→**Paste**.

8.3 Using Bluetooth

Bluetooth is a short-range wireless communication technology. Devices with Bluetooth capabilities can exchange information over a distance of about 10 meters without requiring a physical connection.

Before transferring files, you must turn on Bluetooth and establish a Bluetooth partnership between the device and the other device.

Turning on Bluetooth

1. Select **Start**→**Settings**→**Connections** tab→**Bluetooth**→**Mode** tab.
2. Select the **Turn on Bluetooth** option.

Creating a Bluetooth Partnership

1. Select **Start**→**Settings**→ **Connections** tab→ **Bluetooth**, then select the **Device** tab.
2. Select **Add new device**. The device searches for other Bluetooth-enabled devices and displays them in the list.
3. Select the device with which you want to create a Bluetooth partnership, then select **Next**. If the device you are looking for does not appear in the list, ensure that it is in range and that it has been made discoverable, then select **Refresh**.

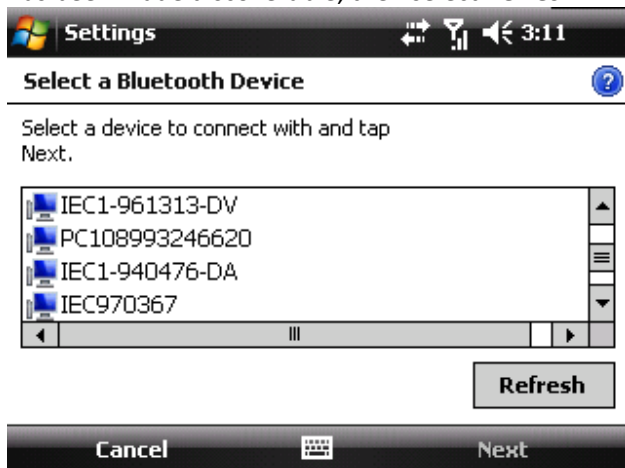

4. In **Passcode**, enter an alphanumeric passcode between 1 and 16 characters, then select **Next**. Otherwise, leave the passcode blank. For security reasons, it is strongly recommended that you use a passcode.
5. Enter the same passcode on the other device (there will be a prompt to do so).
6. Select the service to use from the partner device, and select **Finish**. One of the most common examples of this is to choose the Microsoft ActiveSync service from the list of your PC's available Bluetooth services.

Receiving a File

Before receiving files, you must allow incoming beams. Select **Start**→**Settings**→**Connections** tab→**Beam**, then enable the **Receive all incoming beams** option.

To receive beamed information, the device must first be made discoverable.

1. Select **Start**→**Settings**→**Connections** tab→**Bluetooth**, then select the **Mode** tab.
2. Select **Make this device visible to other devices**.
3. On your PC (or other Bluetooth-enabled device), locate the file or item you want to send. For example, on your PC you would use Windows Explorer to locate the file.
4. In the example above, right-click the file and select the destination device under “to Bluetooth.”
5. Select **Yes** when the device prompts about receiving a file.
6. After the transmission process is finished, the file should be saved in **My Documents** on the device.

Beaming an Item

Once you create a partnership, the two partnered Bluetooth-enabled devices don't need to be discoverable to communicate. In Calendar, Contacts, Notes, Tasks and Pictures, you can beam files and information to other devices using Bluetooth.

1. Turn on Bluetooth. Select **Start**→**Settings**→**Connections** tab→ **Bluetooth**→**Mode** tab. Select the **Turn on Bluetooth** checkbox.
2. Select an item you want to beam. For example, open a task in Tasks.
3. Select **Menu**→**Beam**.
4. Select the destination device.
5. Select **OK** after the transfer is done.

NOTE: If the target device does not appear in the list, ensure that the device is powered on, discoverable and within close range of the device. Also, ensure that Bluetooth has been enabled on the device.

Bluetooth is turned off by default. However, if you turn Bluetooth on the device will remember this setting and turn it back on automatically whenever the device powers up. To save battery power, please remember to turn Bluetooth off after beaming information.

Chapter 9: Other Applications

9.1 Windows Live Messenger

You can send instant messages over the Internet with Windows Live Messenger.

NOTE: The device must be connected to the Internet before you can start using Windows Live Messenger. To connect to the Internet, refer to “Chapter 7. Connecting to the Internet” for details.

You must have a valid Microsoft .NET Passport or Hotmail account before you can sign in to Windows Live Messenger.

Signing In To Windows Live Messenger

1. Select **Start**→**Programs**→**Messenger**.
2. In **Sign in as**, choose a display status (e.g. Online or Busy), then select **Sign in**.



3. Before using Windows Live messenger for the first time, you have to accept the Windows Live Terms of Use and Privacy Statement. Select **Accept** to continue.
4. Enter your Windows Live ID and password and select **Next**.
5. Select whether to show Windows Live on the Today screen or not. Then select **Next**.

6. Choose from the Sync options and select **Next**.



Choose among the following options:

Store Windows Live contacts in your mobile phone's contact list

Merge duplicate contacts

[Learn more](#)

Sync e-mail

Next

Cancel

7. Windows Live will then sign you in online.

To sign out of Windows Live Messenger

Select **Menu**→**Sign out**.

Adding/Deleting a Windows Live Messenger Contact

1. Sign in to Windows Live Messenger.
2. Do any of the following:
 - To add a contact, select **Menu**→**Add New Contact**, then follow the on-screen instructions.
 - To delete a contact, select and hold the contact name in the Windows Live contact list, select **View contact's info**→**Menu**→**Delete Contact**.

Sending an Instant Message

1. Sign into Windows Live Messenger.
2. Select the contact's name, then select **Send IM**.
3. Enter a message, select **Menu**→**Send**.
4. To close the chat window, select **Menu**→**End conversation**.

Changing Windows Live Messenger Settings

1. Sign in to Windows Live Messenger.
2. Select **Menu**→**Options**.
3. Select from the available **options**→**Done**.

9.2 JETCET PDF5





Opening a PDF File

To open a file in JETCET PDF5, select the PDF file in File Explorer or do the following:

1. Select **Start**→**Programs**→**JETCET PDF5**.
2. Select the file that you want to view.
3. If you want to open a file on the network, tap  to select the location and enter the server address.

Viewing the Document

After opening a file with JETCET PDF5, you can choose to view the file in full screen or zoom in/out the file.

- Tap **Menu**→**View**→**Full screen**. Use the four-way navigation pad on the screen to navigate through the document.
- Tap **Menu**→**View**→**Tools**. Select  to fit the width of the page onto the screen. Select  to display the entire page on-screen. Select / to zoom in/out the file in the range from 25% to 200%.

9.3 Windows Media

The device comes with Windows Media Player pre-loaded, which allows you to play digital audio and video files stored locally or on a network.







Transferring Music and Videos to the device

If you want to store the media files to a storage card, insert a MicroSD card on the device before connecting the device to a PC.

1. On your computer, open **Windows Media Player**.
2. Connect the device to your computer using a USB cable.
3. In Windows Media Player on your computer, click **Sync**.
4. Drag each item you want to synchronize to the device pane on the right side of the Windows Media Player window.
5. At the bottom of the device pane, click **Start Sync**. This will start the synchronization process.
6. After transferring your media files, update your mobile device Media Library:
 - a. Select **Start**→**Programs**→**Windows Media**.
 - b. Select **Menu**→**Library**→**My Device**.
 - c. Select the **Library**→**Storage Card** if the files are stored in the MicroSD card. Otherwise, skip this step.
 - d. Select **Menu**→**Update Library**.
 - e. Select **Done** when update is completed.

Playing Media Files on the device

1. Select **Menu**→**Library** to open the Library screen.
2. Select a category (e.g. My Music > All Music).
3. Select an item then select **Play**.
4. You can then use the following functions when playing audio or video files:

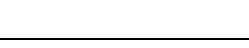
-  : Display the video in full screen.
-  : Launches a Web site where you can find music and videos to play.
-  : Skip to the beginning of the current file or to the previous file.
-  : Pause/Play.
-  : Skip to the next file.
-  : Decrease the volume level.
-  : Increase the volume level.
-  : Move to a different position in the currently playing track.

Saving a New Playlist

1. Select **Start**→**Programs**→**Windows Media**.
2. Select **Menu**→**Library**.
3. Select a category (e.g. My Music > All Music).
4. Select an item, select **Menu**→**Queue Up**. Selected item will be added to the Now Playing list immediately.
5. Select **Menu**→**Now Playing**.
6. Select **Menu**→**Save Playlist**.
7. Enter a name for the playlist, then select **Done**.

On the Windows Media playback screen you can Select **Menu**→**Options** to change playback settings.

9.4 MIDlet Manager

A MIDlet is a Java program which can be downloaded from the Internet Explorer Mobile and work on the device. You can use MIDlet Manager to handle all Java files on the device, including download, installation, upgrade and deletion of MIDlets.

Installing a MIDlet

1. Select **Start**→**Program**→**MIDlet Manager**.
2. Select **Actions**→**Install**, select whether to install the MIDlet from local storage or a website.
 - To download and install the MIDlet from a website, launch the MIDlet hyperlink on the website and then follow prompts on the screen to complete the installation.
 - To install the MIDlet from local storage, double click on the file and then follow on-screen prompts to complete the installation.
3. Select **OK** on the screen.

9.5 Phone Profile

Profiles define how the device reacts when you receive a call or a message, how your keypad sounds when you press a key and more. Select or customize the most suitable profile for your environment, such as when you are in a meeting or outdoors. The profiles available are: Normal, Silent, Vibrate, Outdoor and Headset. Each of them can be renamed or customized to fit your own needs.

Viewing Profile Details

You can view the default of each profile by doing the following:

1. Select **Start**→**Programs**→**Phone Profile**.
2. Select a profile, select **Menu**→**System Profile**.

Editing a Profile

1. Select **Start**→**Programs**→**Phone Profile**.
2. Select a profile then select **Edit**.
3. Select your preferred sound options for calls and messaging.
4. Select the **Advance** tab to set dial pad sound or auto-answering function.
5. Select **OK** to apply the changes.

Restoring a Profile

1. Select **Start**→**Programs**→**Phone Profile**.
2. Do either of the following:
 - Select the profile that you want to restore to default, select **Menu**→**Restore Selected**.
 - Select **Menu**→**Restore All** to restore all profiles to default.
3. Select **OK**.

Using Audio Files as Ring Tones

You can use your own audio file as a ring tone. The device supports .wav, .wma, .mid (type 0), .mp3 audio format files as ring tones. For the audio files to be recognized by the profiles as ring tones, you must place your audio files in one of the following folders:

- My Device\Windows
- My Device\Windows\Rings
- Storage Card\Rings

Open File Explorer, Select and hold the file, and then select the **Set As Ringtone** command.

9.6 GPS

A GPS (Global Positioning System) signal receiver is built in the device. You have to install a mapping software on the device to start navigating. Please follow the instruction of your mapping software to install it and use the navigation functions. You may need to specify the GPS hardware port when installing the mapping software. Select the following value if requested.

- GPS hardware port: COM9.
- Baud rate: 9600.

IMPORTANT: Some mapping software or GPS navigation software may not be compatible with the device, please consult with the software provider/retailer before installing the software.

Receiving Better Satellite Signals

GPS positioning is limited by bad weather (e.g. rainy or cloudy days) and usage location (e.g. tall buildings, tunnels, underpasses, trees, bridges...etc). Most GPS do not work indoors, nor can GPS signals penetrate buildings, car sun shades and heat reflective film with metallic content.

It can take several minutes the first time you establish a GPS connection. If you find the device can not detect the satellite signal, try the following:

- Move the device to an open space without tall buildings or trees around it.
- Make sure there are no wireless communication products (e.g. radar-detecting devices and mobile phones) nearby since these products may cause unstable signal reception.
- Connect an external Bluetooth GPS receiver (not included in the package) to the device in order to enhance the reception.

Important Notice about Using GPS

- Please set navigation destinations before driving. It is forbidden in most counties to operate the GPS system when driving.
- The GPS is built and operated by the US Defense Department. The accuracy of location data may be affected by changes made by the Department.
- GPS should not be used for precise location measurement. It can only be used as a navigation aid.
- Do not turn on the car engine when the device is connected to the car charger (not included in the package) as this may damage the device.
- Make sure the DC voltage provided by your car and the electric current supplied from your car charger are compatible with the device before using them.
- Using the GPS may drain the battery faster than usual.

9.7 Internet Sharing

With Internet Sharing, you can connect your PC or notebook to the Internet by using the device's networking capability.

NOTE: Please remember to install a valid SIM card and establish a GPRS or dial-up connection before using Internet Sharing.

In order to use a USB cable connection, you have to install ActiveSync or WMDC on your PC (refer to chapter three).

Please disable ActiveSync or WMDC before launching Internet Sharing.

Setting up the Device as a USB Modem

1. Select **Start** → **Programs** → **Internet Sharing**.
2. In **PC Connection**, select **USB**.
3. In **Network Connection**, select the connection that you want to use.
4. Connect the device to your PC with the USB cable.
5. Tap **Connect** on the device.

Setting up the Device as a Bluetooth Modem

1. Establish a Bluetooth partnership between the device and your PC (refer to chapter 8.3) and make sure Bluetooth on the device and your PC are turned on.
2. Select **Start** → **Programs** → **Internet Sharing**.
3. In **PC Connection**, select **Bluetooth PAN**.

4. In **Network Connection**, select the connection that you want to use.
5. Tap **Connect** on the device.
6. Set up a Bluetooth PAN (Personal Area Network) on your PC.
7. Tap **Connect** on the device.

Chapter 10: Camera

10.1 Overview

The built-in Camera application allows you to use the camera /microphone to capture videos and images. Your camera has the following features:

Single image capture
Time controlled capture
Video capture
Quality, size and file format options
Special effects
Advanced options including anti-flicker, storage location, reset counter

To open the camera, press and hold the camera button on the side of the device.

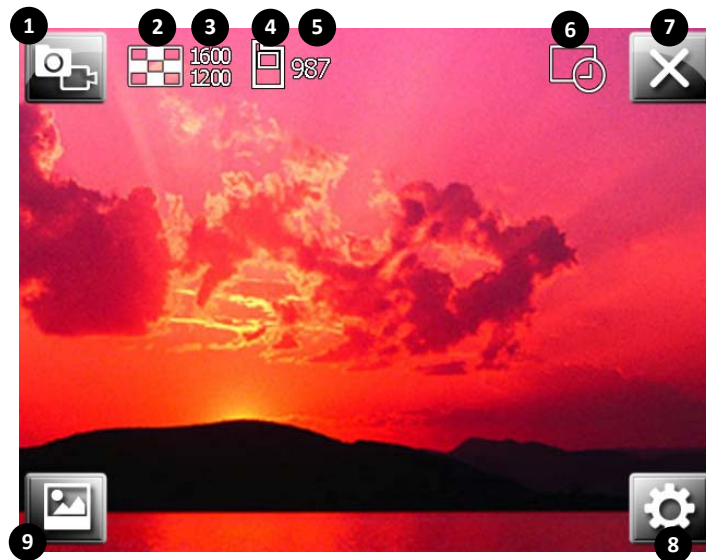

1. Capture mode
2. Resolution
3. Quality
4. Storage location
5. Shots remaining
6. Single shot/Timer
7. Close
8. Settings
9. View all pictures

10.2 Taking a picture

1. Press and hold the camera button to launch the camera application.
2. Position the device so that the image you want to capture of is displayed on the screen.
3. Press the camera button to take the picture.

10.3 Taking a video







1. Press and hold the camera button to launch the camera application.
2. If the camera is in still capture mode, press the capture mode icon on the top left.
3. Position the device so that image you want to capture is displayed on the screen.
4. Press the camera button to start recording.
5. Press the camera button to stop recording.

10.4 Settings and Options



To access settings, press . Press  to switch between menu pages.





Still Camera

	Shooting mode	Single-shot, Timer-shot
	Resolution	UGA(16000*1200), VGA(640*480), QVGA(320*240)
	Effect	Off, Negative, Monochrome, Sepia
	Anti flicker	Off, 50Hz, 60Hz
	Quality	High, Low, Normal
	Other	My Documents/Storage Card: select where you want to save your files. Reset Counter: reset the file naming counter back to 1.

Video Camera Settings

	Effect	Off, Negative, Monochrome, Sepia
	Resolution	QCIF(176*144), QVGA(320*240)

	Video format	3GP, MP4
	Other	My Documents/Storage Card: select where you want to save your files. Reset Counter: reset the file naming counter back to 1.

10.5 Pictures and Videos

Viewing and Editing Pictures

To view captured pictures, tap . Scroll to a picture and do any of the following:

- Select **Menu**. You can see a list of options for managing the picture (e.g. Delete).
- Select **View**. You can view the selected picture.
- Select **View** and then select **Menu**. From the menu list, you can Zoom in/out, edit and rename the picture.

Viewing and Managing Videos

1. Select **Start**→**Programs**→**Pictures & Videos**.
2. Select **My Pictures** ▼, then select My Videos under My Documents.
3. Tap a video clip to play it or select **Menu** to show a list of available options.

Appendix

A.1 Specifications

System Information	
Processor	Qualcomm MSM7201, 400MHz
Operating System	Windows Mobile 6.1 Professional
Memory	128 MB DDR SDRAM 256 MB Flash ROM

Dimensions and Weight	
Dimensions	116 x 62 x 15 mm
Weight	145 g with battery

Keys and Notifications	
Keys	Jog ball Velocity Button Volume up and down Start OK OK (side) Record (configurable) Camera Button (configurable) Power Button SEND and END QWERTY Keypad Reset Button
Notifications	Vibrate Audible Visual message LED: GSM/UMTS (Green Blink) Missed call/Message Notification (Blue Blink) Charging (Red) Full Charged (Green)

Display	
Type	TFT LCD with touch panel and backlight
Size/Resolution	2.46" QVGA 320x240 65K colors

Cellular connectivity	
Band	GSM/GPRS/EDGE: 850, 900, 1800, 1900 MHz UMTS/HSDPA/HSUPA: 850, 1900, 2100 MHz UMTS up to 384k download and upload HSDPA/HSUPA up to 7.2Mbps download and 2Mbps upload

System	GSM/GPRS/EDGE class 10 supported
Antenna	Embedded (2G/3G all band, Wi-Fi, GPS, Bluetooth)

Connectivity and Interface

Bluetooth	2.0 compliant + EDR
SDIO	Supported, MicroSD form factor
USB	USB 2.0 Full Speed, mini USB (Active sync and charging)
Wi-Fi	802.11b/g compliant

External Memory Card

Card Slot	MicroSD with SDIO
-----------	-------------------

Battery and Power

Battery/Capacity	Lithium-Ion Polymer Cell, 1410 mAh
Talk/Standby Time	4 hours / 200 hours (average)

Camera Module

Type	Main camera: 2.0 MP CMOS sensor camera with Fix Focus Second camera: 0.3MP CMOS
Max Resolution	16000 x 1200

GPS

Chipset	Qualcomm gpsOne (MSM7201 integrated)
GPS Receiver	8 channels
AGPS compatible	Yes

Others

Headset Connector	2.5mm stereo connector
TV-out	Through 2.5mm audio jack with AV cable

A.2 Regulatory Notices

Regulatory Agency IDs

For regulatory identification purposes, your product is assigned a model number of Velocity 111. To ensure continued reliable and safe operation of the device, use only the accessories listed below with your Velocity 111.

The Battery Pack has been assigned a model number of Velocity 111.

This product is intended for use with a certified Class 2 Limited Power Source, rated 5 Volts DC, maximum 1 Amp power supply unit.

European Union Notice

Products with CE marking comply with the R&TTE Directive (99/5/EC), the EMC Directive (89/336/EEC), and the Low Voltage Directive (73/23/EEC) issued by the Commission of the European Community. Compliance with these directives implies conformity to the following European Norms (in parentheses are the equivalent international standards).

- ETSI EN 301 489-1
Electromagnetic compatibility and Radio spectrum Matters (ERM); ElectroMagnetic Compatibility (EMC) standard for radio equipment and services; Part 1: Common technical requirements.
- ETSI EN 300 328
Electromagnetic compatibility and Radio spectrum Matters (ERM); Wideband Transmission systems; data transmission equipment operating in the 2.4 GHz ISM band and using spread spectrum modulation techniques.
- EN 50360/EN50361
Product standard to demonstrate the compliance of mobile phones with the basic restrictions related to human exposure to electromagnetic fields (300MHz – 3GHz)
- ETSI EN 301 489-7
Electromagnetic compatibility and Radio spectrum matters (ERM); ElectroMagnetic Compatibility (EMC) standard for radio equipment and services; Part 7: Specific conditions for mobile and portable radio and ancillary equipment of digital cellular radio telecommunications systems (GSM and DCS).
- ETSI EN 301 489-17
Electromagnetic compatibility and Radio spectrum Matters (ERM); ElectroMagnetic Compatibility (EMC) standard for radio equipment and services; Part 17: Specific conditions for 2.4 GHz wideband transmission systems and 5 GHz high performance RLAN equipment.
- EN 60950-1 (IEC 60950-1)
Safety of information Technology Equipment.
- ETSI EN 301 511
Global system for mobile communications (GSM); Harmonized EN for mobile stations in the GSM 900 and GSM 1800 bands, covering essential requirements of article 3.2 of the R&TT directive (1995/5/EC).



Federal Communications Commission Notice

This device complies with part 15 of the FCC Rules. Operation is subject to the following two conditions: (1) This device may not cause harmful interference, and (2) this device must accept any interference received, including interference that may cause undesired operation. This equipment has been tested and found to comply with the limits for a Class B digital device, pursuant to Part 15 of the FCC Rules. These limits are designed to provide reasonable protection against harmful interference in a residential installation. This equipment generates, uses, and can radiate radio frequency energy and, if not installed and used in accordance with the instructions, may cause harmful interference to radio communications. However, there is no guarantee this equipment does not cause harmful interference to radio or TV reception. This can be determined by turning the equipment on and off. The user is encouraged to try to correct the interference by one or more of the following measures:

- Reorient or relocate the receiving antenna.
- Increase the separation between the equipment and receiver.
- Connect the equipment into an outlet on a circuit different from that to which the receiver is connected.
- Consult the dealer or an experienced radio or television technician for help.

For body worn operation, this device has been tested and meets FCC RF exposure guidelines when used with an accessory that contains no metal and that positions the device a minimum of 1.5 cm from the body. Use of other accessories may not ensure compliance with FCC RF exposure guideline.

SAR Information

- 0.633W/Kg @1g (FCC) head
- 1.050W/Kg @1g (FCC) body

Exposure to Radio Frequency (RF) Signals

Your wireless phone is a radio transmitter and receiver. It is designed and manufactured not to exceed the emission limits for exposure to radio frequency (RF) energy set by the Federal Communications Commission of the U.S. Government. These limits are part of comprehensive guidelines and establish permitted levels of RF energy for the general population. The guidelines are based on the safety standards previously set by both U.S. and international standards bodies:

- American National Standards Institute (ANSI) IEEE. C95.1-1992
- National Council on Radiation Protection and Measurement (NCRP). Report 86. 1986
- International Commission on Non-Ionizing Radiation Protection (ICNIRP) 1996
- Ministry of Health (Canada), Safety Code 6. The standards include a substantial safety margin designed to assure the safety of all persons, regardless of age and health.

In the U.S. and Canada, the SAR limit for mobile phones used by the public is 1.6 Watts/kg (W/kg) averaged over one gram of tissue. The standard incorporates a substantial margin of safety to give additional protection for the public and to account for any variations in usage. Normal conditions only ensure the radiative performance and safety of the interference. As with other mobile radio transmitting equipment, users are advised that for satisfactory operation of the equipment and for personal safety reasons, it is recommended that no part of the human body be allowed to come too close to the antenna during operation of the equipment.

WEEE Notice

The Waste Electrical and Electronic Equipment (WEEE) Directive is designed to encourage and regulate the collection, re-use, recycling and recovery of waste electrical and electronic equipment, which entered into force as European law on 13th February 2003. The Directive aims to improve the level of recycling of electrical and electronic equipment (EEE) and encourages designers to develop products with recycling efficiency in mind; it also aims to improve our environment and reduce risks to human health through the proper treatment of discarded goods.

The WEEE logo () on the product and its accessories or on its box indicates that this product must not be disposed of or dumped with your other household waste. You are liable to dispose of all your electronic or electrical waste equipment by relocating over to the specified collection point for recycling of such hazardous waste. Isolated collection and proper recovery of your electronic and electrical waste equipment at the time of disposal will allow us to help conserve natural resources and reduce harm to the environment and human health.

For more information about electronic and electrical waste equipment disposal, recovery and collection points, please contact your local government office, household waste disposal service, the retailer from where you purchased the equipment, or the manufacturer of the equipment.

RoHS Compliance

This product is in compliance with Directive 2002/95/EC of the European Parliament and of the Council of 27 January 2003, on the restriction of the use of certain hazardous substances in electrical and electronic equipment (RoHS) and its amendment.

Warning!

DANGER OF EXPLOSION IF BATTERY IS INCORRECTLY REPLACED. TO REDUCE RISK OF FIRE OR BURNS, DO NOT DISASSEMBLE, CRUSH, PUNCTURE, SHORT EXTERNAL CONTACTS, EXPOSE TO TEMPERATURE ABOVE 60.C (140.F), OR DISPOSE OF IN FIRE OR WATER. REPLACE ONLY WITH SPECIFIED BATTERIES. RECYCLE OR DISPOSE OF USED BATTERIES ACCORDING TO THE LOCAL REGULATIONS OR REFERENCE GUIDE SUPPLIED WITH YOUR PRODUCT.



A.3 PC Requirement to Run ActiveSync 4.5

To connect the device to a Windows PC running any Windows operating system prior to Windows Vista*, you must have Microsoft® ActiveSync® program installed on your PC. ActiveSync 4.5 is included in the Installation CD, which is compatible with the following operating systems and applications:

- Microsoft® Windows® 2000 Service Pack 4
- Microsoft® Windows® Server 2003 Service Pack 1
- Microsoft® Windows® Server 2003 IA64 Edition Service Pack 1
- Microsoft® Windows® Server 2003 x64 Edition Service Pack 1
- Microsoft® Windows® XP Professional Service Packs 1 and 2
- Microsoft® Windows® XP Home Service Packs 1 and 2
- Microsoft® Windows® XP Tablet PC Edition 2005
- Microsoft® Windows® XP Media Center Edition 2005
- Microsoft® Windows® XP Professional x64 Edition
- Microsoft® Outlook® 98, Microsoft® Outlook® 2000 and Microsoft® Outlook® XP, and Microsoft® Outlook® 2003 messaging and collaboration clients
- Microsoft® Office 97, excluding Outlook
- Microsoft® Office 2000
- Microsoft® Office XP
- Microsoft® Office 2003
- Microsoft® Internet Explorer 4.01 or later (required)
- Microsoft® Systems Management Server 2.0

* If you are a Windows Vista user please use Windows Mobile Device Center, not Microsoft ActiveSync, for device connectivity between your Windows Mobile device and Windows Vista.