

FCC Radio Test Report

FCC ID: DI2CT-EM2531

This report concerns (check one) : Original Grant Class II Change

Issued Date : Dec. 25, 2007

Project No. : 0711C138

Equipment : Zigbee Module

Model Name : EM2531

Applicant : Computime Limited

Address : 17/F, Great Eagle Centre 23 Harbour
Road, Wanchai, HongKong.

Tested by:

Neutron Engineering Inc. EMC Laboratory

Date of Test:

Nov. 28, 2007 ~ Dec. 25, 2007

Testing Engineer :

(Tendy Huang)

Technical Manager :

(Steven Lu)

Authorized Signatory :

(Vic Chiu)

NEUTRON ENGINEERING INC.

No. 132-1, Lane 329, Sec. 2, Palain Rd.,
Shijr City, Taipei, Taiwan
TEL : (02) 2646-5426 FAX : (02) 2646-6815



Declaration

Neutron represents to the client that testing is done in accordance with standard procedures as applicable and that test instruments used has been calibrated with the standards traceable to National Measurement Laboratory (**NML**) of **R.O.C.**, or National Institute of Standards and Technology (**NIST**) of **U.S.A.**

Neutron's reports apply only to the specific samples tested under conditions. It is manufacture's responsibility to ensure that additional production units of this model are manufactured with the identical electrical and mechanical components. **Neutron** shall have no liability for any declarations, inferences or generalizations drawn by the client or others from **Neutron** issued reports.

Neutron's reports must not be used by the client to claim product endorsement by the authorities or any agency of the Government.

This report is the confidential property of the client. As a mutual protection to the clients, the public and **Neutron-self**, extracts from the test report shall not be reproduced except in full with **Neutron's** authorized written approval.

Neutron's laboratory quality assurance procedures are in compliance with the **ISO Guide 17025** requirements, and accredited by the conformity assessment authorities listed in this test report.

Limitation

For the use of the authority's logo is limited unless the Test Standard(s)/Scope(s)/Item(s) mentioned in this test report is (are) included in the conformity assessment authorities acceptance respective.

Table of Contents	Page
1 . CERTIFICATION	5
2 . SUMMARY OF TEST RESULTS	6
2.1 TEST FACILITY	7
2.2 MEASUREMENT UNCERTAINTY	7
3 . GENERAL INFORMATION	8
3.1 GENERAL DESCRIPTION OF EUT	8
3.2 DESCRIPTION OF TEST MODES	10
3.3 TABLE OF PARAMETERS OF TEXT SOFTWARE SETTING	10
3.4 BLOCK DIGRAM SHOWING THE CONFIGURATION OF SYSTEM TESTED	11
3.5 DESCRIPTION OF SUPPORT UNITS	12
4 . EMC EMISSION TEST	13
4.1 CONDUCTED EMISSION MEASUREMENT	13
4.1.1 POWER LINE CONDUCTED EMISSION LIMITS	13
4.1.2 MEASUREMENT INSTRUMENTS LIST AND SETTING	13
4.1.3 TEST PROCEDURE	14
4.1.4 DEVIATION FROM TEST STANDARD	14
4.1.5 TEST SETUP	14
4.1.6 EUT OPERATING CONDITIONS	15
4.1.7 TEST RESULTS	16
4.2 RADIATED EMISSION MEASUREMENT	18
4.2.1 RADIATED EMISSION LIMITS	18
4.2.2 MEASUREMENT INSTRUMENTS LIST ANS SETTING	19
4.2.3 TEST PROCEDURE	20
4.2.4 DEVIATION FROM TEST STANDARD	20
4.2.5 TEST SETUP	21
4.2.6 EUT OPERATING CONDITIONS	21
4.2.7 TEST RESULTS (BETWEEN30 – 1000 MHZ)	22
4.2.8 TEST RESULTS (ABOVE 1000 MHZ)	24
4.2.9 TEST RESULTS (RESTRICTED BANDS REQUIREMENTS)	36
5 . BANDWIDTH TEST	40
5.1 APPLIED PROCEDURES / LIMIT	40
5.1.1 MEASUREMENT INSTRUMENTS LIST	40
5.1.2 TEST PROCEDURE	40
5.1.3 DEVIATION FROM STANDARD	40
5.1.4 TEST SETUP	40
5.1.5 EUT OPERATION CONDITIONS	40

Table of Contents	Page
5.1.6 TEST RESULTS	41
6 . PEAK OUTPUT POWER TEST	43
6.1 APPLIED PROCEDURES / LIMIT	43
6.1.1 MEASUREMENT INSTRUMENTS LIST	43
6.1.2 TEST PROCEDURE	43
6.1.3 DEVIATION FROM STANDARD	43
6.1.4 TEST SETUP	43
6.1.5 EUT OPERATION CONDITIONS	43
6.1.6 TEST RESULTS	44
7 . ANTENNA CONDUCTED SPURIOUS EMISSION	45
7.1 APPLIED PROCEDURES / LIMIT	45
7.1.1 MEASUREMENT INSTRUMENTS LIST	45
7.1.2 TEST PROCEDURE	45
7.1.3 DEVIATION FROM STANDARD	45
7.1.4 TEST SETUP	45
7.1.5 EUT OPERATION CONDITIONS	46
7.1.6 TEST RESULTS	47
8 . POWER SPECTRAL DENSITY TEST	49
8.1 APPLIED PROCEDURES / LIMIT	49
8.1.1 MEASUREMENT INSTRUMENTS LIST	49
8.1.2 TEST PROCEDURE	49
8.1.3 DEVIATION FROM STANDARD	49
8.1.4 TEST SETUP	49
8.1.5 EUT OPERATION CONDITIONS	49
8.1.6 TEST RESULTS	50
9 . RF EXPOSURE TEST	52
9.1 APPLIED PROCEDURES / LIMIT	52
9.1.1 MEASUREMENT INSTRUMENTS LIST	52
9.1.2 MPE CALCULATION METHOD	52
9.1.3 DEVIATION FROM STANDARD	53
9.1.4 TEST SETUP	53
9.1.5 EUT OPERATION CONDITIONS	53
9.1.6 TEST RESULTS	54
10 . EUT TEST PHOTO	55

1. CERTIFICATION

Equipment : Zigbee Module

Trade Name : Computime

Model Name : EM2531

Applicant : Computime Limited

Test Item : ENGINEERING SAMPLE

Standards : FCC Part15, Subpart C(15.247) / ANCI C63.4 : 2003

The above equipment has been tested and found compliance with the requirement of the relative standards by Neutron Engineering Inc. EMC Laboratory.

The test data, data evaluation, and equipment configuration contained in our test report (Ref No. NEI-FCCP-1-0711C138) were obtained utilizing the test procedures, test instruments, test sites that has been accredited by the Authority of NVLAP and TAF according to the ISO-17025 quality assessment standard and technical standard(s).

Test result included in this report is only for the Zigbee part of the product.

2. SUMMARY OF TEST RESULTS

Test procedures according to the technical standards:

FCC Part15 (15.247) , Subpart C			
Standard Section	Test Item	Judgment	Remark
15.207	Conducted Emission	PASS	
15.247 (c)	Antenna conducted Spurious Emission	PASS	
15.247 (a)(2)	6dB Bandwidth	PASS	
15.247 (b)	Peak Output Power	PASS	
15.247 (c)	Radiated Spurious Emission	PASS	
15.247 (d)	Power Spectral Density	PASS	
15.203	Antenna Requirement	PASS	
1.1307 1.1310 2.1091 2.1093	RF Exposure Compliance	PASS	

NOTE:

(1) "N/A" denotes test is not applicable in this Test Report

2.1 TEST FACILITY

The test facilities used to collect the test data in this report is **C01/OS02** at the location of No.132-1, Lane 329, Sec. 2, Palain Road, Shijr City, Taipei, Taiwan.
 Neutron's test firm number is 95335

2.2 MEASUREMENT UNCERTAINTY

The reported uncertainty of measurement $y \pm U$, where expended uncertainty **U** is based on a standard uncertainty multiplied by a coverage factor of **k=2**, providing a level of confidence of approximately **95 %**.

A. Conducted Measurement :

Test Site	Method	Measurement Frequency Range	U , (dB)	NOTE
C01	ANSI	150 KHz ~ 30MHz	1.94	

B. Radiated Measurement :

Test Site	Method	Measurement Frequency Range	Ant. H / V	U , (dB)	NOTE
OS-01	ANSI	30MHz ~ 200MHz	V	3.82	
		30MHz ~ 200MHz	H	3.60	
		200MHz ~ 1,000MHz	V	3.86	
		200MHz ~ 1,000MHz	H	3.94	
OS-02	ANSI	30MHz ~ 200MHz	V	2.48	
		30MHz ~ 200MHz	H	2.16	
		200MHz ~ 1,000MHz	V	2.50	
		200MHz ~ 1,000MHz	H	2.66	

3. GENERAL INFORMATION

3.1 GENERAL DESCRIPTION OF EUT

Equipment	Zigbee Module
Trade Name	Computime
Model Name	EM2531
OEM Brand/Model Name	N/A
Model Difference	N/A
Product Description	The EUT is a Zigbee Module.
	Operation Frequency: 2405~2480 MHz
	Modulation Type: Offset-QPSK
	Bit Rate of Transmitter 250Kb/s
	Number Of Channel 16 CH
	Antenna Designation: Please see Note 3.
	Antenna Gain(Peak) Please see Note 3.
	Output Power: 0.07 dBm (Max.)
Based on the application, features, or specification exhibited in User's Manual, the EUT is considered as an ITE/Computing Device. More details of EUT technical specification, please refer to the User's Manual.	
Channel List	Please refer to the Note 2.
Power Source	DC Voltage supplied from System (from DC Battery)
Power Rating	DC 4.5V (IN) power regulation 2.1VMin~3.6VMax (OUT)
Connecting I/O Port(s)	Please refer to the User's Manual
Products Covered	N/A
EUT Modification(s)	N/A

Note:

1. For a more detailed features description, please refer to the manufacturer's specifications or the User's Manual.

2.

Frequency Band	Channel No.	Frequency
2400~2483.5MHz	1	2405 MHz
	2	2410 MHz
	3	2415 MHz
	4	2420 MHz
	5	2425 MHz
	6	2430 MHz
	7	2435 MHz
	8	2440 MHz
	9	2445 MHz
	10	2450 MHz
	11	2455 MHz
	12	2460 MHz
	13	2465 MHz
	14	2470 MHz
	15	2475 MHz
	16	2480 MHz

3.

Table for Filed Antenna

Ant.	Brand	Model Name	Antenna Type	Connector	Gain (dBi)
1	-	-	Printed Antenna	NA	1.0

3.2 DESCRIPTION OF TEST MODES

To investigate the maximum EMI emission characteristics generates from EUT, the test system was pre-scanning tested base on the consideration of following EUT operation mode or test configuration mode which possible have effect on EMI emission level. Each of these EUT operation mode(s) or test configuration mode(s) mentioned above was evaluated respectively.

Test Items	Mode	Data Rate	Channel	Antenna
AC Power Line Conducted Emissions	Zigbee	-	-	-
Maximum Peak Conducted Output Power Power Spectral Density 6dB Spectrum Bandwidth	Zigbee	250Kb/s	1/9/16	1
Radiated Emissions 9kHz~1GHz	Zigbee	250Kb/s	9	1
Radiated Emissions 1GHz~10 th Harmonic	Zigbee	250Kb/s	1/9/16	1
Band Edge Emissions	Zigbee	250Kb/s	1/16	1

Note:

- (1) The measurements are performed at the highest, middle, lowest available channels.

3.3 TABLE OF PARAMETERS OF TEXT SOFTWARE SETTING

During testing channel & power controlling software provided by the customer was used to control the operating channel as well as the output power level. The RF output power selection is for the setting of RF output power expected by the customer and is going to be fixed on the firmware of the final end product power parameters of Zigbee

Test software Version	Test program: Hardware control		
Frequency	2405 MHz	2445 MHz	2480 MHz
Parameters	DEF	DEF	DEF

3.4 BLOCK DIGRAM SHOWING THE CONFIGURATION OF SYSTEM TESTED

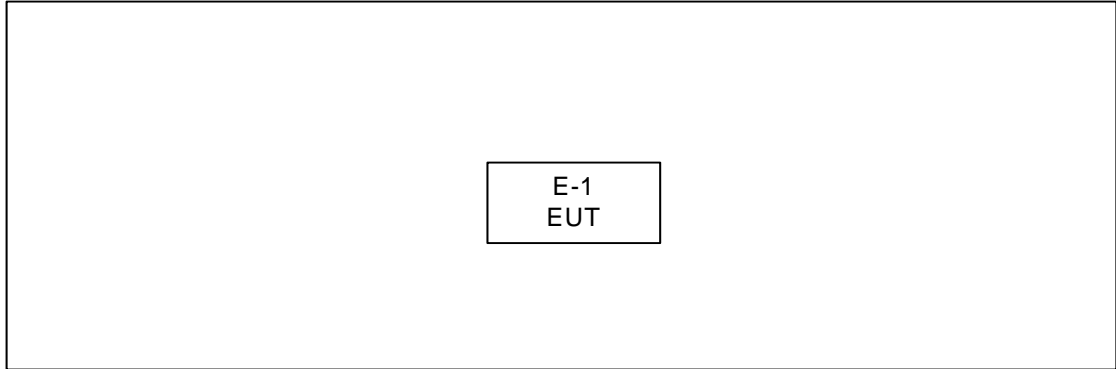

3.5 DESCRIPTION OF SUPPORT UNITS

The EUT has been tested as an independent unit together with other necessary accessories or support units. The following support units or accessories were used to form a representative test configuration during the tests.

Item	Equipment	Mfr/Brand	Model/Type No.	FCC ID	Series No.	Note
E-1	Zigbee Module	Computime	EM2531	D12CT-EM2531	N/A	EUT

Item	Shielded Type	Ferrite Core	Length	Note

Note:

- (1) The support equipment was authorized by Declaration of Confirmation.
- (2) For detachable type I/O cable should be specified the length in cm in 『Length』 column.

4. EMC EMISSION TEST

4.1 CONDUCTED EMISSION MEASUREMENT

4.1.1 POWER LINE CONDUCTED EMISSION Limits (Frequency Range 150KHz-30MHz)

FREQUENCY (MHz)	Class A (dBuV)		Class B (dBuV)		Standard
	Quasi-peak	Average	Quasi-peak	Average	
0.15 -0.5	79.00	66.00	66 - 56 *	56 - 46 *	CISPR
0.50 -5.0	73.00	60.00	56.00	46.00	CISPR
5.0 -30.0	73.00	60.00	60.00	50.00	CISPR

0.15 -0.5	79.00	66.00	66 - 56 *	56 - 46 *	FCC
0.50 -5.0	73.00	60.00	56.00	46.00	FCC
5.0 -30.0	73.00	60.00	60.00	50.00	FCC

Note:

- (1) The tighter limit applies at the band edges.
- (2) The limit of " * " marked band means the limitation decreases linearly with the logarithm of the frequency in the range.

4.1.2 MEASUREMENT INSTRUMENTS LIST AND SETTING

Item	Kind of Equipment	Manufacturer	Type No.	Serial No.	Calibrated until
1	LISN	Rolf Heine	NNB-2/16Z	98053	Dec. 27, 2007
2	Pulse Limiter	Electro-Metrics	EM-7600	112644	Nov. 27, 2008
3	Test Cable	N/A	C01	N/A	Nov. 27, 2008
4	EMI Test Receiver	R&S	ESCI	100082	Mar. 08, 2008

Remark: " N/A" denotes No Model No. , Serial No. or No Calibration specified.

The following table is the setting of the receiver

Receiver Parameters	Setting
Attenuation	10 dB
Start Frequency	0.15 MHz
Stop Frequency	30 MHz
IF Bandwidth	9 kHz

4.1.3 TEST PROCEDURE

- a. The EUT was placed 0.4 meters from the horizontal ground plane with EUT being connected to the power mains through a line impedance stabilization network (LISN). All other support equipments powered from additional LISN(s). The LISN provide 50 Ohm/ 50uH of coupling impedance for the measuring instrument.
- b. Interconnecting cables that hang closer than 40 cm to the ground plane shall be folded back and forth in the center forming a bundle 30 to 40 cm long.
- c. I/O cables that are not connected to a peripheral shall be bundled in the center. The end of the cable may be terminated, if required, using the correct terminating impedance. The overall length shall not exceed 1 m.
- d. LISN at least 80 cm from nearest part of EUT chassis.
- e. For the actual test configuration, please refer to the related Item –EUT Test Photos.

4.1.4 DEVIATION FROM TEST STANDARD

No deviation

4.1.5 TEST SETUP

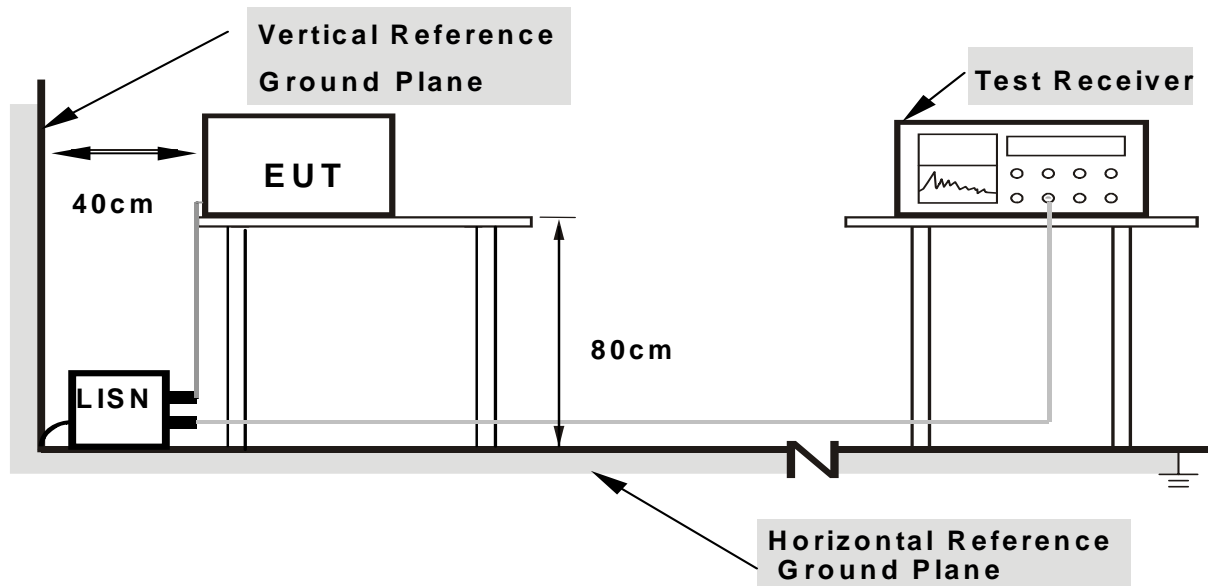

Note: 1.Support units were connected to second LISN.

2.Both of LISNs (AMN) are 80 cm from EUT and at least 80 from other units and other metal planes

4.1.6 EUT OPERATING CONDITIONS

The EUT was configured for testing in a typical fashion (as a customer would normally use it). The EUT has been programmed to continuously transmit during test. This operating condition was tested and used to collect the included data.

The eut power from DC Battery (4.5VDC),The record not in report
(1) "N/A" denotes test is not applicable in this Test Report

4.1.7 TEST RESULTS

EUT :	Zigbee Module	Model No. :	EM2531
Temperature :	22 °C	Relative Humidity :	60%
Pressure :	1010 hPa	Test Voltage :	DC 4.5V
Test Mode :	TX Mode		

Freq. (MHz)	Terminal L/N	Measured(dBuV)		Limits(dBuV)		Margin (dB)	Note
		QP-Mode	AV-Mode	QP-Mode	AV-Mode		
0.20	Line	45.19	*	63.74	53.74	-18.55	(QP)
0.27	Line	38.01	*	61.24	51.24	-23.23	(QP)
1.07	Line	38.41	*	56.00	46.00	-17.59	(QP)
4.79	Line	36.27	*	56.00	46.00	-19.73	(QP)
13.50	Line	36.62	*	60.00	50.00	-23.38	(QP)
18.25	Line	38.66	*	60.00	50.00	-21.34	(QP)

Remark

- (1) All readings are QP Mode value unless otherwise stated AVG in column of Note. If the QP Mode Measured value compliance with the QP Limits and lower than AVG Limits, the EUT shall be deemed to meet both QP & AVG Limits and then only QP Mode was measured, but AVG Mode didn't perform. In this case, a " * " marked in AVG Mode column of Interference Voltage Measured.
- (2) Measuring frequency range from 150KHz to 30MHz.

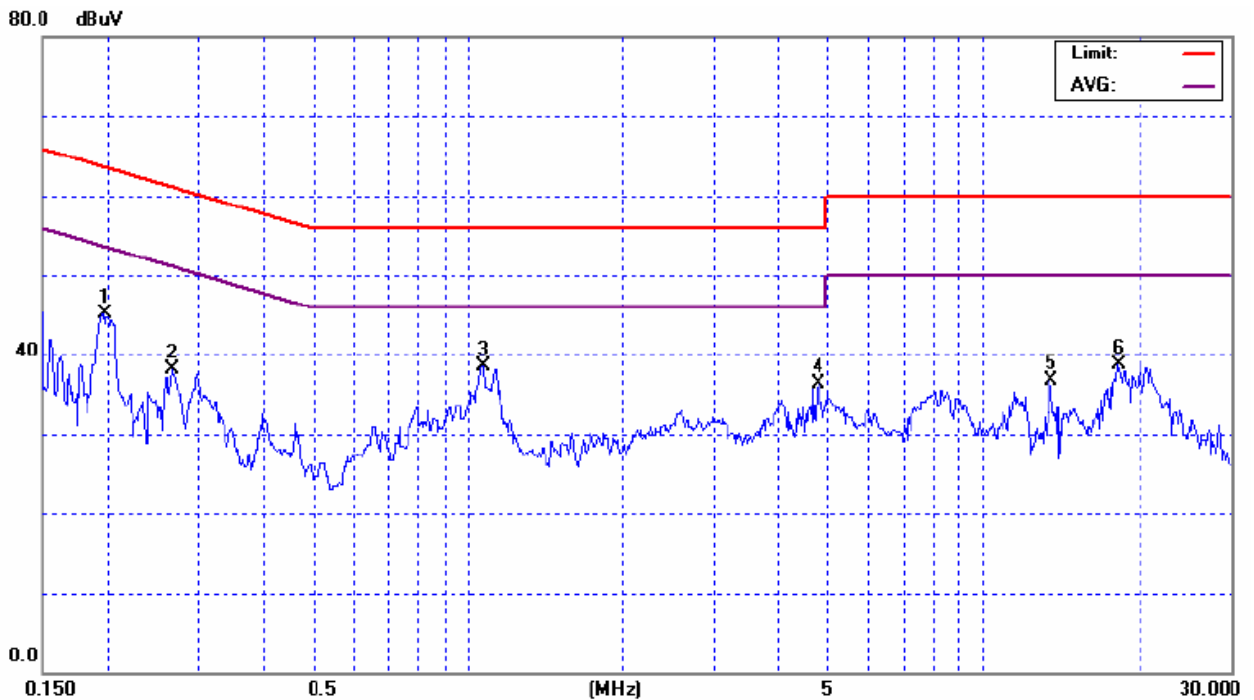

EUT :	Zigbee Module	Model No. :	EM2531
Temperature :	22 °C	Relative Humidity :	60%
Pressure :	1010 hPa	Test Voltage :	DC 4.5V
Test Mode :	TX Mode		

Freq. (MHz)	Terminal L/N	Measured(dBuV)		Limits(dBuV)		Margin (dB)	Note
		QP-Mode	AV-Mode	QP-Mode	AV-Mode		
0.20	Neutral	46.44	*	63.57	53.57	-17.13	(QP)
0.40	Neutral	40.34	*	57.91	47.91	-17.57	(QP)
0.73	Neutral	36.71	*	56.00	46.00	-19.29	(QP)
2.27	Neutral	36.16	*	56.00	46.00	-19.84	(QP)
13.50	Neutral	33.47	*	60.00	50.00	-26.53	(QP)
19.10	Neutral	32.44	*	60.00	50.00	-27.56	(QP)

Remark

- (1) All readings are QP Mode value unless otherwise stated AVG in column of Note. If the QP Mode Measured value compliance with the QP Limits and lower than AVG Limits, the EUT shall be deemed to meet both QP & AVG Limits and then only QP Mode was measured, but AVG Mode didn't perform. In this case, a "*" marked in AVG Mode column of Interference Voltage Measured.
- (2) Measuring frequency range from 150KHz to 30MHz.

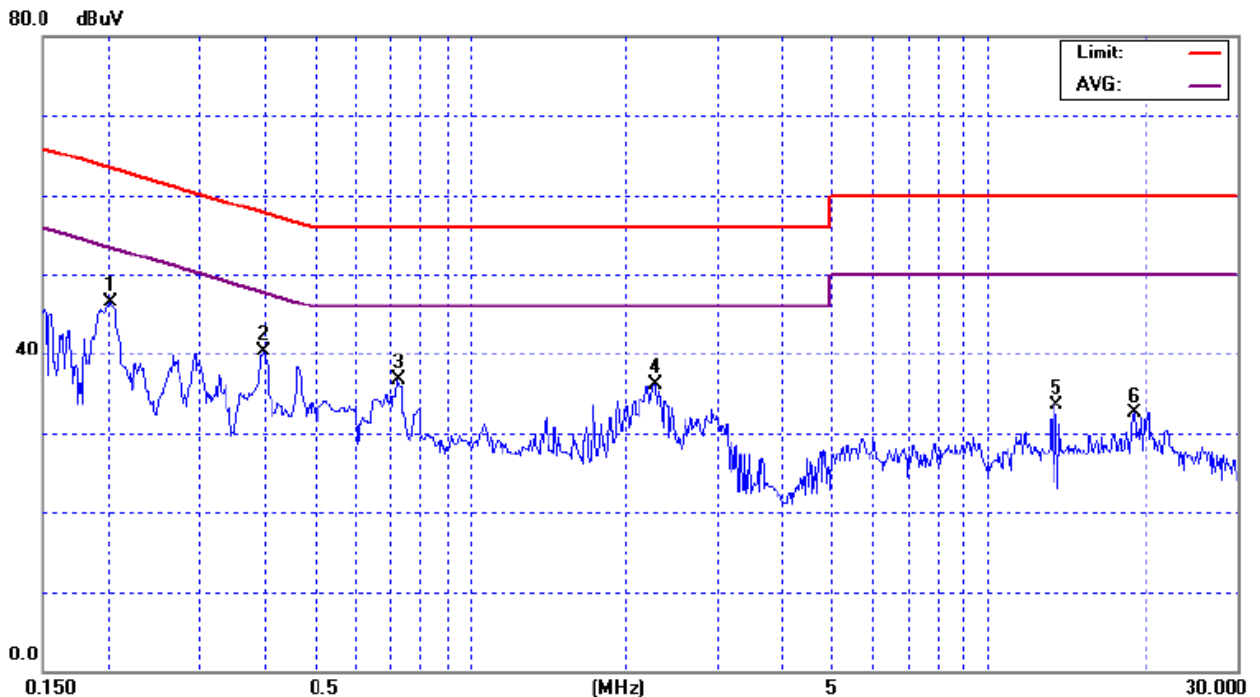

4.2 RADIATED EMISSION MEASUREMENT

4.2.1 RADIATED EMISSION LIMITS (Frequency Range 9KHz-1000MHz)

20dBc in any 100 kHz bandwidth outside the operating frequency band. In case the emission fall within the restricted band specified on 15.205(a), then the 15.209(a) limit in the table below has to be followed.

Frequencies (MHz)	Field Strength (micorvolts/meter)	Measurement Distance (meters)
0.009~0.490	2400/F(KHz)	300
0.490~1.705	24000/F(KHz)	30
1.705~30.0	30	30
30~88	100	3
88~216	150	3
216~960	200	3
Above 960	500	3

LIMITS OF RADIATED EMISSION MEASUREMENT (Above 1000MHz)

FREQUENCY (MHz)	Class A (dBuV/m) (at 3m)		Class B (dBuV/m) (at 3m)	
	PEAK	AVERAGE	PEAK	AVERAGE
Above 1000	80	60	74	54

Notes:

- (1) The limit for radiated test was performed according to FCC PART 15B.
- (2) The tighter limit applies at the band edges.
- (3) Emission level (dBuV/m)=20log Emission level (uV/m).

FREQUENCY RANGE OF RADIATED MEASUREMENT (For unintentional radiators)

Highest frequency generated or Upper frequency of measurement used in the device or on which the device operates or tunes (MHz)	Range (MHz)
Below 1.705	30
1.705 – 108	1000
108 – 500	2000
500 – 1000	5000
Above 1000	5 th harmonic of the highest frequency or 40 GHz, whichever is lower

4.2.2 MEASUREMENT INSTRUMENTS LIST AND SETTING

Item	Kind of Equipment	Manufacturer	Type No.	Serial No.	Calibrated until
1	Log-Bicon Antenna	Schwarzbeck	VULB 9160	3058	Mar. 20, 2008
2	Test Cable	N/A	10M_OS02	N/A	Nov. 27, 2008
3	Test Cable	N/A	OS02-1/-2/-3	N/A	Nov. 27, 2008
4	Pre-Amplifier	Anritsu	MH648A	M09961	Nov. 27, 2008
5	Pre-Amplifier	Agilent	8449B	3008A0171 4	May,14, 2008
6	Spectrum Analyzer	R&S	FSP_40	100129	Jan, 08, 2008
7	EMI Test Receiver	R&S	ESCI	100082	Mar. 08, 2008
8	Horn Antenna	Schwarzbeck	BBHA9120D	9120D-325	Dec. 12, 2008
9	Horn Antenna	Schwarzbeck	BBHA9170	9170-187	Dec. 10, 2008
10	Antenna Mast	Chance Most	CMTB-1.5	N/A	N/A
11	Turn Table	Chance Most	CMTB-1.5	N/A	N/A

Remark: " N/A" denotes No Model Name / Serial No. and No Calibration specified.

Spectrum Parameter	Setting
Attenuation	Auto
Start Frequency	1000 MHz
Stop Frequency	10th carrier harmonic
RB / VB (emission in restricted band)	1MHz / 1MHz for Peak, 1 MHz / 10Hz for Average
RB / VB (other emission)	100KHz / 100KHz for peak

Receiver Parameter	Setting
Attenuation	Auto
Start ~ Stop Frequency	9kHz~150kHz / RB 200Hz for QP
Start ~ Stop Frequency	150kHz~30MHz / RB 9kHz for QP
Start ~ Stop Frequency	30MHz~1000MHz / RB 120kHz for QP

4.2.3 TEST PROCEDURE

- a. The measuring distance of at 3 m shall be used for measurements at frequency up to 1GHz. For frequencies above 1GHz, any suitable measuring distance may be used.
- b. The EUT was placed on the top of a rotating table 0.8 meters above the ground at a 3 meter open area test site. The table was rotated 360 degrees to determine the position of the highest radiation.
- c. The height of the equipment or of the substitution antenna shall be 0.8 m; the height of the test antenna shall vary between 1 m to 4 m. Both horizontal and vertical polarizations of the antenna are set to make the measurement.
- d. The initial step in collecting conducted emission data is a spectrum analyzer peak detector mode pre-scanning the measurement frequency range. Significant peaks are then marked and then Quasi Peak detector mode re-measured.
- e. If the Peak Mode measured value compliance with and lower than Quasi Peak Mode Limit, the EUT shall be deemed to meet QP Limits and then no additional QP Mode measurement performed.
- f. For the actual test configuration, please refer to the related Item –EUT Test Photos.

4.2.4 DEVIATION FROM TEST STANDARD

No deviation

4.2.5 TEST SETUP

(A) Radiated Emission Test Set-Up, Frequency Below 1000MHz

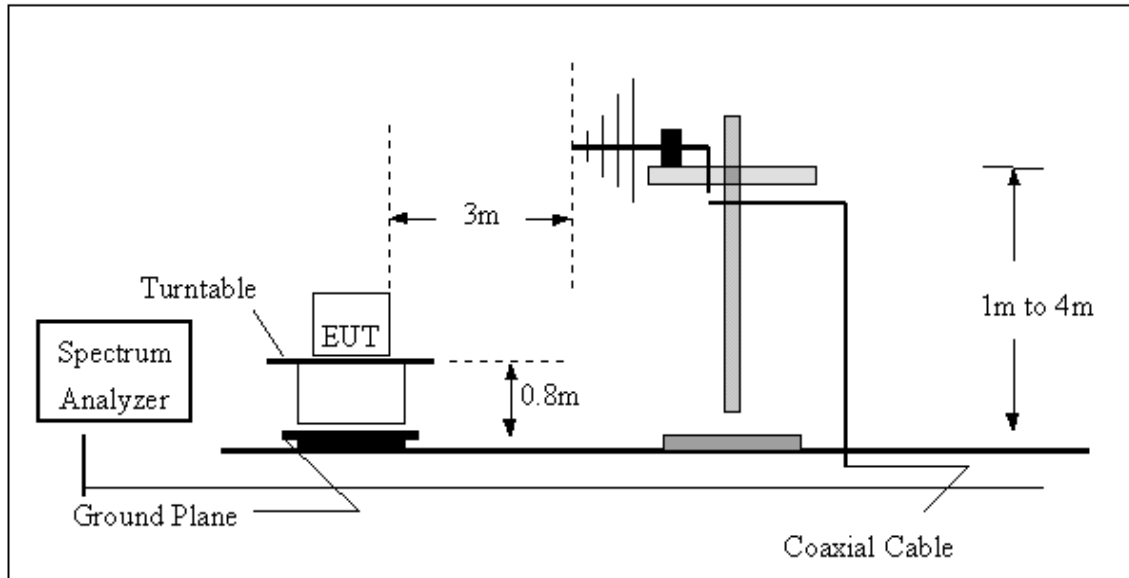

(B) Radiated Emission Test Set-Up Frequency Above 1 GHz

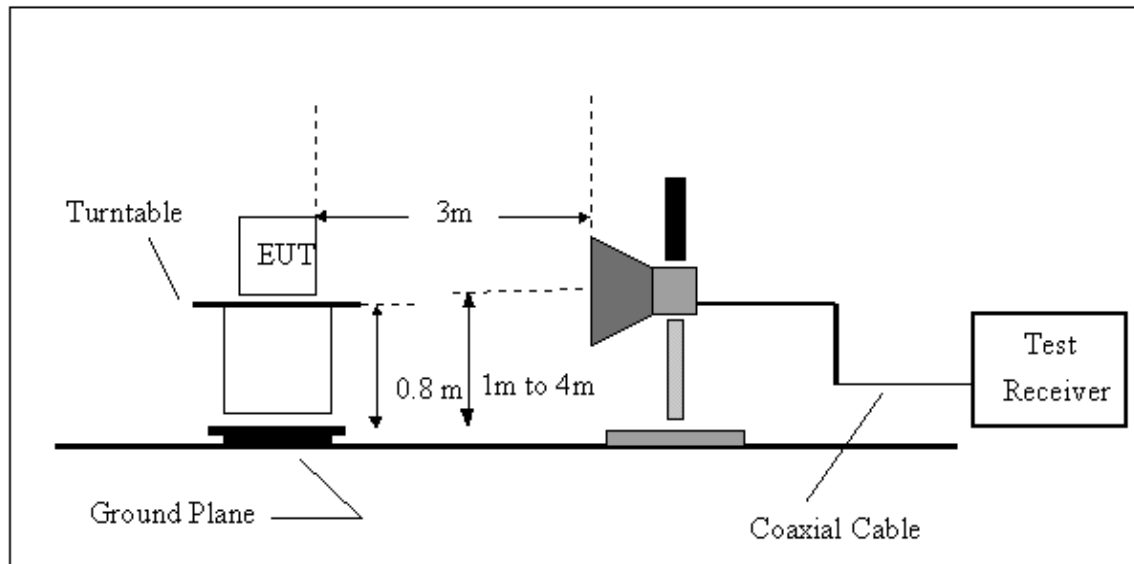

4.2.6 EUT OPERATING CONDITIONS

The EUT tested system was configured as the statements of 4.1.6 Unless otherwise a special operating condition is specified in the follows during the testing.

4.2.7 TEST RESULTS (BETWEEN30 – 1000 MHZ)

EUT :	Zigbee Module	Model No. :	EM2531
Temperature :	22 °C	Relative Humidity :	60%
Pressure :	1010 hPa	Test Voltage :	DC 4.5V
Test Mode :	TX 2445MHz - CH 09		

Freq. (MHz)	Ant. H/V	Reading(RA) (dBuV)	Corr.Factor(CF) (dB)	Measured(FS) (dBuV/m)	Limits(QP) (dBuV/m)	Margin (dB)	Note
45.52	V	38.44	-19.58	18.86	40.00	- 21.14	
61.04	V	39.10	-22.94	16.16	40.00	- 23.84	
239.52	V	40.29	-17.31	22.98	46.00	- 23.02	
262.80	V	41.10	-16.59	24.51	46.00	- 21.49	
288.02	V	40.42	-15.62	24.80	46.00	- 21.20	
311.30	V	37.42	-14.51	22.91	46.00	- 23.09	

Remark :

- (1) Reading in which marked as QP or Peak means measurements by using are Quasi-Peak Mode or Peak Mode with Detector BW=120KHz ; SPA setting in RBW=120KHz, VBW =120KHz, Swp. Time = 0.3 sec./MHz ◦
- (2) All readings are Peak unless otherwise stated QP in column of 『 Note 』 . Peak denotes that the Peak reading compliance with the QP Limits and then QP Mode measurement didn't perform ◦
- (3) Measuring frequency range from 30MHz to 1000MHz ◦
- (4) If the peak scan value lower limit more than 20dB, then this signal data does not show in table ◦

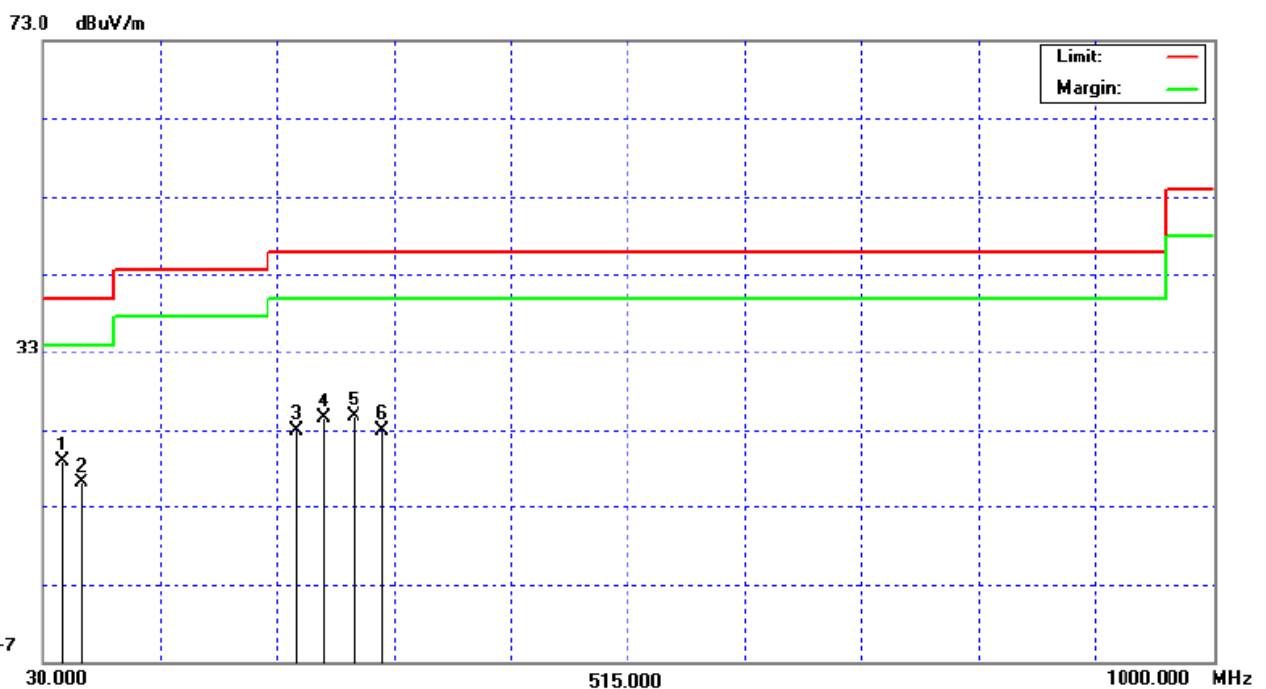

EUT :	Zigbee Module	Model No. :	EM2531
Temperature :	22 °C	Relative Humidity :	60%
Pressure :	1010 hPa	Test Voltage :	DC 4.5V
Test Mode :	TX 2445MHz - CH 09		

Freq. (MHz)	Ant. H/V	Reading(RA) (dBuV)	Corr.Factor(CF) (dB)	Measured(FS) (dBuV/m)	Limits(QP) (dBuV/m)	Margin (dB)	Note
239.52	H	51.35	-17.31	34.04	46.00	- 11.96	
262.80	H	53.23	-16.59	36.64	46.00	- 9.36	
288.02	H	53.32	-15.62	37.70	46.00	- 8.30	
311.30	H	49.11	-14.51	34.60	46.00	- 11.40	
336.52	H	41.90	-13.70	28.20	46.00	- 17.80	
359.80	H	42.49	-13.25	29.24	46.00	- 16.76	

Remark :

- (1) Reading in which marked as QP or Peak means measurements by using are Quasi-Peak Mode or Peak Mode with Detector BW=120KHz ; SPA setting in RBW=120KHz, VBW =120KHz, Swp. Time = 0.3 sec./MHz ◦
- (2) All readings are Peak unless otherwise stated QP in column of 『Note』 . Peak denotes that the Peak reading compliance with the QP Limits and then QP Mode measurement didn't perform ◦
- (3) Measuring frequency range from 30MHz to 1000MHz ◦
- (4) If the peak scan value lower limit more than 20dB, then this signal data does not show in table ◦

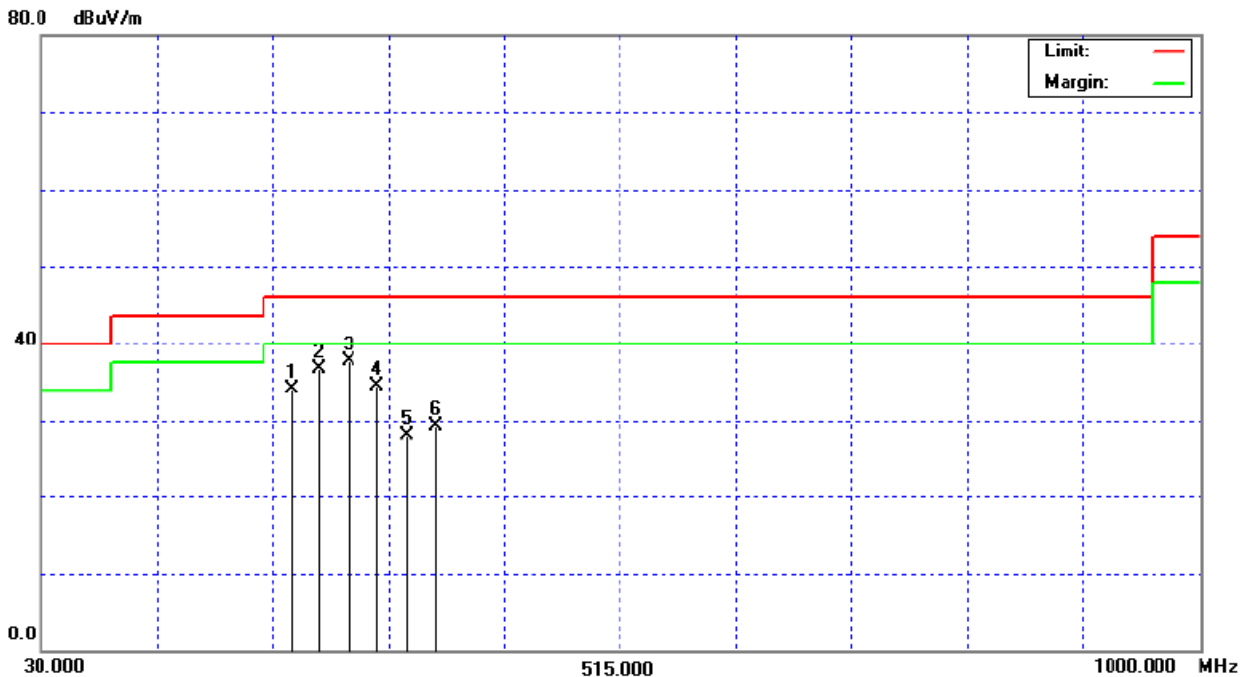

4.2.8 TEST RESULTS (ABOVE 1000 MHZ)

EUT :	Zigbee Module	Model No. :	EM2531
Temperature :	22 °C	Relative Humidity :	60%
Pressure :	1010 hPa	Test Voltage :	DC 4.5V
Test Mode :	TX 2405MHz - CH 01		

Freq.	Ant.Pol.	Reading		Ant./CF	Act.		Limit		Note
		Peak	AV		Peak	AV	Peak	AV	
(MHz)	H/V	(dBuV)	(dBuV)	CF(dB)	(dBuV/m)	(dBuV/m)	(dBuV/m)	(dBuV/m)	
2390.00	V	20.57	9.84	32.05	52.62	41.89	74.00	54.00	Y/E
2404.96	V	56.46	53.92	32.10	88.56	86.02			Y/F
4810.07	V	46.03	36.89	3.53	49.56	40.42	74.00	54.00	Y/H

Remark :

- (1) All readings are Peak unless otherwise stated QP in column of 『Note』 . Peak denotes that the Peak reading compliance with the QP Limits and then QP Mode measurement didn't perform .
- (2) Measuring frequency range from 30MHz to 1000MHz or the 10th harmonic of highest fundamental frequency . "F" denotes fundamental frequency; "H" denotes spurious frequency. "E" denotes band edge frequency. (This judgment method includes the Band Edge Requirement.)
- (3) Radiated emissions measured in frequency range above 1000MHz were made with an instrument using Peak detector mode and AV detector mode of the emission .
- (4) Data of measurement within this frequency range shown " * " in the table above means the reading of emissions are attenuated more than 20dB below the permissible limits or the field strength is too small to be measured.
- (5) A preamp and high pass filter were used for this test in order to provide sufficient measurement sensitivity.
- (6) EUT Orthogonal Axis :
 "X" - denotes Laid on Table ; "Y" - denotes Vertical Stand ; "Z" - denotes Side Stand

TX CH01 (Above 1000 MHz, Vertical)

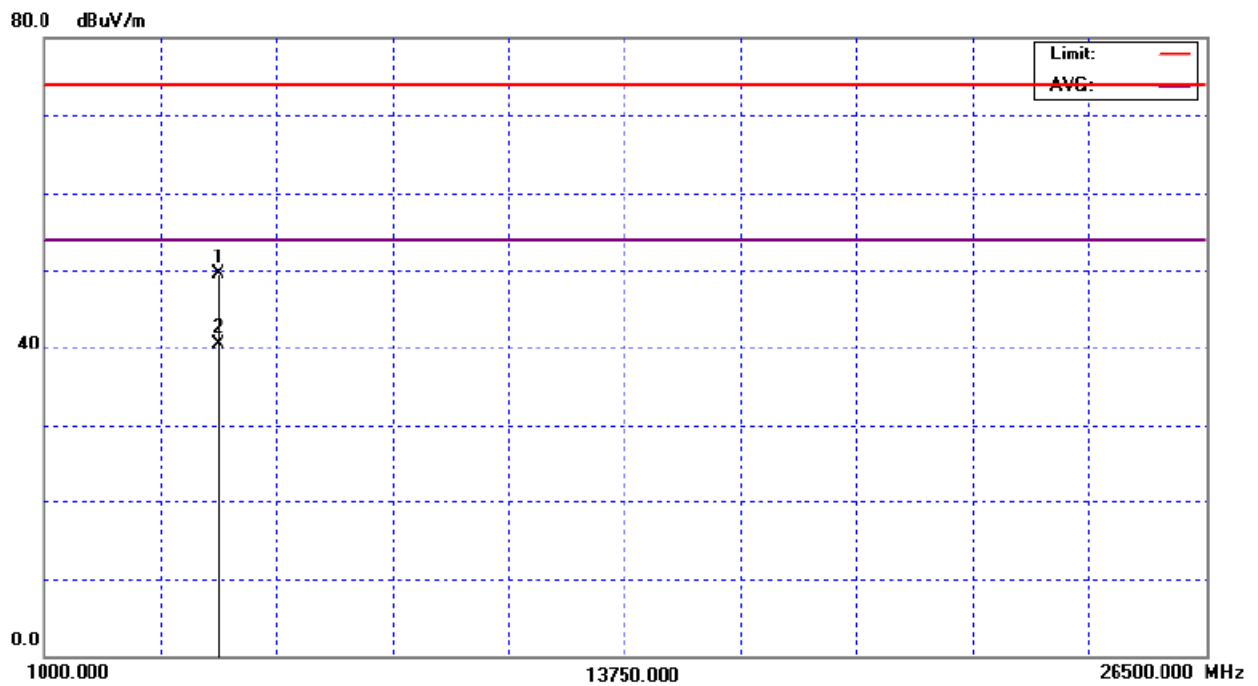
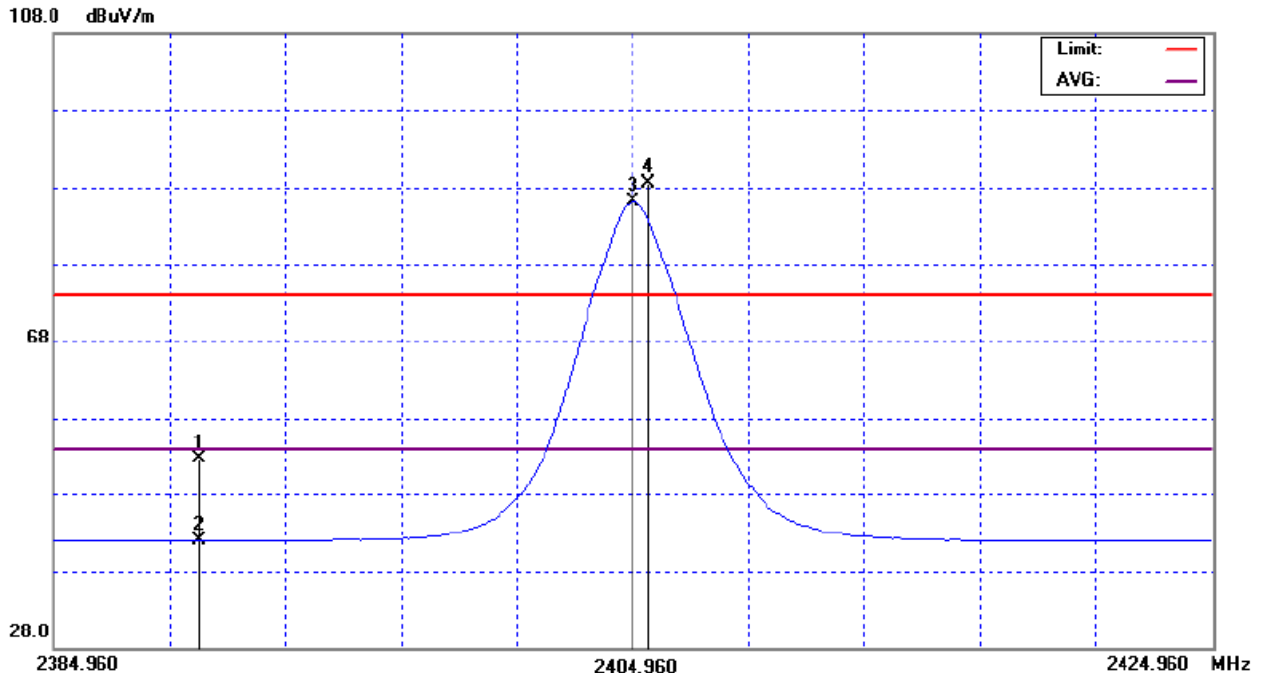

EUT :	Zigbee Module	Model No. :	EM2531
Temperature :	22 °C	Relative Humidity :	60%
Pressure :	1010 hPa	Test Voltage :	DC 4.5V
Test Mode :	TX 2405MHz - CH 01		

Freq. (MHz)	Ant.Pol. H/V	Reading		Ant./CF CF(dB)	Act.		Limit		Note
		Peak (dBuV)	AV (dBuV)		Peak (dBuV/m)	AV (dBuV/m)	Peak (dBuV/m)	AV (dBuV/m)	
2390.00	H	21.96	9.87	32.05	54.01	41.92	74.00	54.00	Y/E
2404.96	H	55.99	53.43	32.10	88.09	85.53			Y/F
4810.15	H	48.76	38.79	3.53	52.29	42.32	74.00	54.00	Y/H

Remark :

- (1) All readings are Peak unless otherwise stated QP in column of 『Note』 . Peak denotes that the Peak reading compliance with the QP Limits and then QP Mode measurement didn't perform .
- (2) Measuring frequency range from 30MHz to 1000MHz or the 10th harmonic of highest fundamental frequency . "F" denotes fundamental frequency; "H" denotes spurious frequency. "E" denotes band edge frequency. (This judgment method includes the Band Edge Requirement.)
- (3) Radiated emissions measured in frequency range above 1000MHz were made with an instrument using Peak detector mode and AV detector mode of the emission .
- (4) Data of measurement within this frequency range shown " * " in the table above means the reading of emissions are attenuated more than 20dB below the permissible limits or the field strength is too small to be measured.
- (5) A preamp and high pass filter were used for this test in order to provide sufficient measurement sensitivity.
- (6) EUT Orthogonal Axis :
 "X" - denotes Laid on Table ; "Y" - denotes Vertical Stand ; "Z" - denotes Side Stand

TX CH01 (Above 1000 MHz, Horizontal)

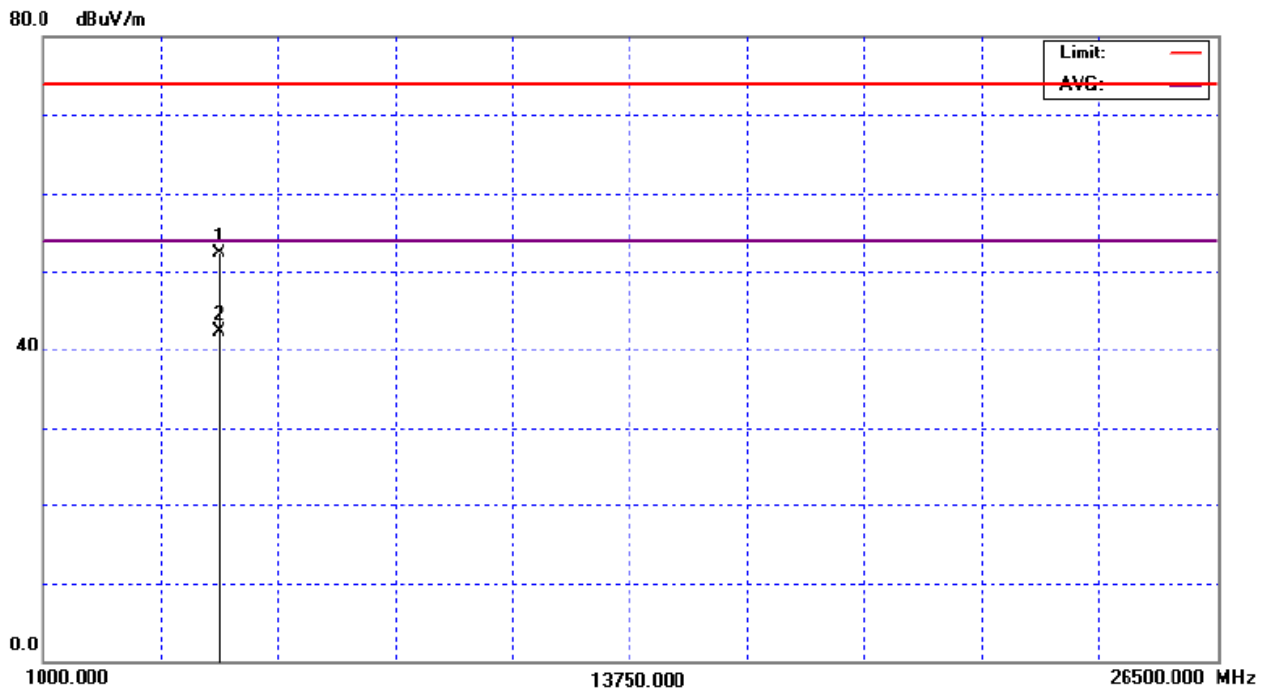
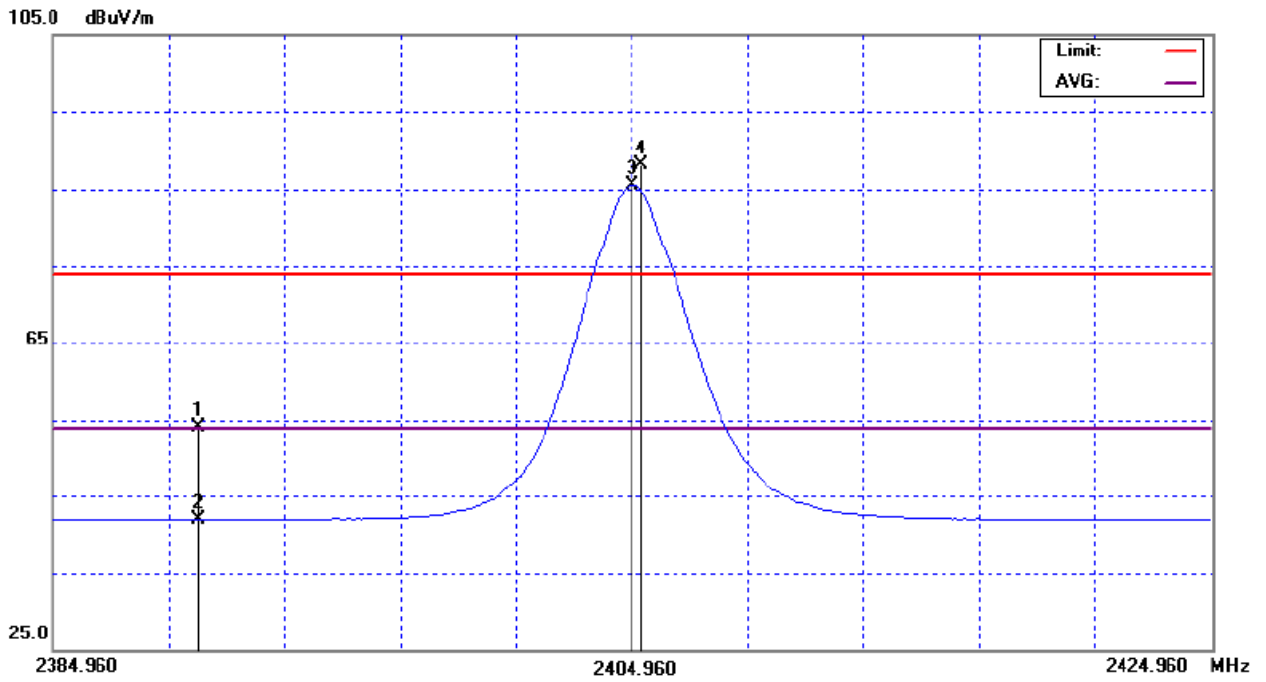

EUT :	Zigbee Module	Model No. :	EM2531
Temperature :	22 °C	Relative Humidity :	60%
Pressure :	1010 hPa	Test Voltage :	DC 4.5V
Test Mode :	TX 2445MHz - CH 09		

Freq.	Ant.Pol.	Reading		Ant./CF	Act.		Limit		Note
		Peak	AV		Peak	AV	Peak	AV	
(MHz)	H/V	(dBuV)	(dBuV)	CF(dB)	(dBuV/m)	(dBuV/m)	(dBuV/m)	(dBuV/m)	
2445.04	V	54.61	52.21	32.22	86.84	84.43			Y/F
4890.30	V	45.98	38.20	3.77	49.75	41.97	74.00	54.00	Y/H

Remark :

- (1) All readings are Peak unless otherwise stated QP in column of 『 Note 』 . Peak denotes that the Peak reading compliance with the QP Limits and then QP Mode measurement didn't perform .
- (2) Measuring frequency range from 30MHz to 1000MHz or the 10th harmonic of highest fundamental frequency . "F" denotes fundamental frequency; "H" denotes spurious frequency. "E" denotes band edge frequency. (This judgment method includes the Band Edge Requirement.)
- (3) Radiated emissions measured in frequency range above 1000MHz were made with an instrument using Peak detector mode and AV detector mode of the emission .
- (4) Data of measurement within this frequency range shown " * " in the table above means the reading of emissions are attenuated more than 20dB below the permissible limits or the field strength is too small to be measured.
- (5) A preamp and high pass filter were used for this test in order to provide sufficient measurement sensitivity.
- (6) EUT Orthogonal Axis :
 "X" - denotes Laid on Table ; "Y" - denotes Vertical Stand ; "Z" - denotes Side Stand

TX CH09 (Above 1000 MHz, Vertical)

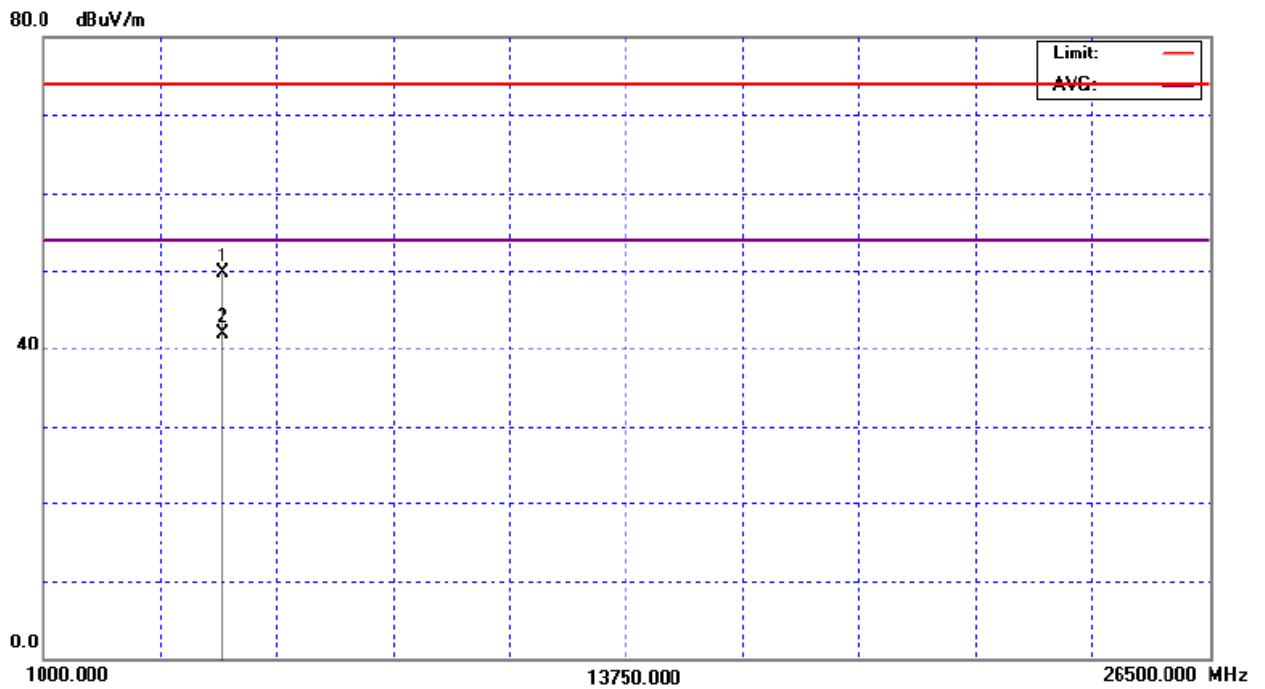
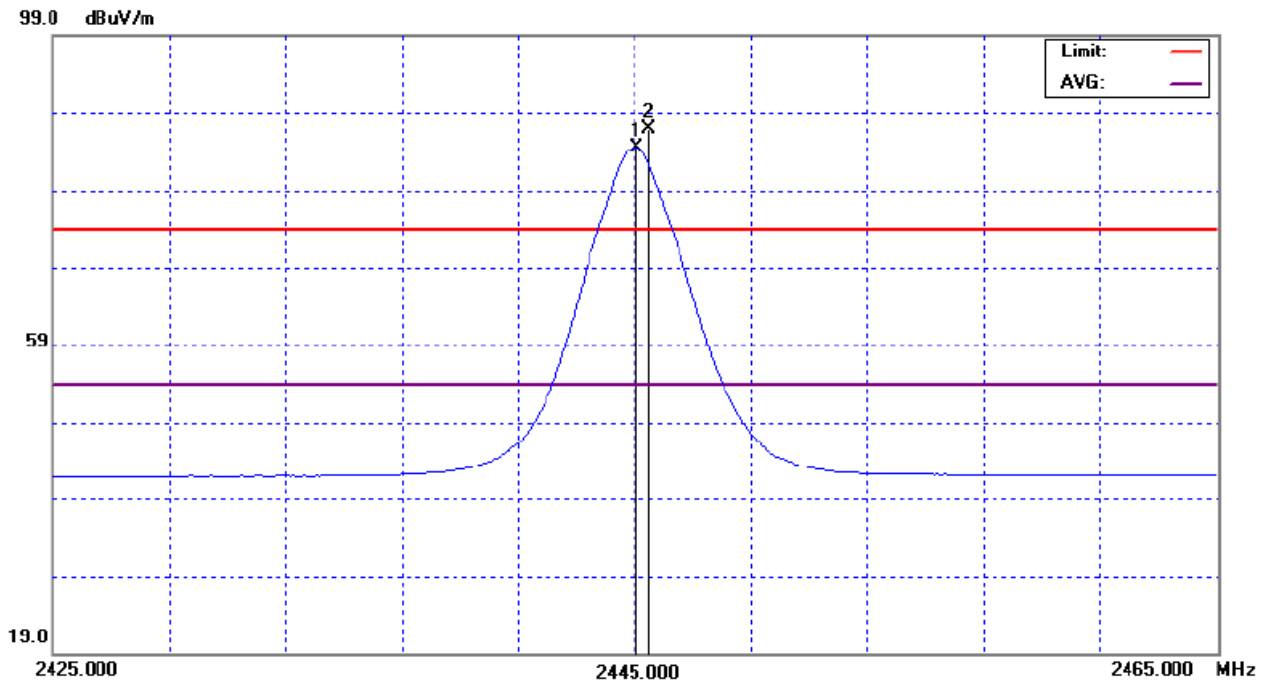

EUT :	Zigbee Module	Model No. :	EM2531
Temperature :	22 °C	Relative Humidity :	60%
Pressure :	1010 hPa	Test Voltage :	DC 4.5V
Test Mode :	TX 2445MHz –CH 09		

Freq.	Ant.Pol.	Reading		Ant./CF	Act.		Limit		Note
		Peak	AV		Peak	AV	Peak	AV	
(MHz)	H/V	(dBuV)	(dBuV)	CF(dB)	(dBuV/m)	(dBuV/m)	(dBuV/m)	(dBuV/m)	
2445.00	H	60.33	58.03	32.22	92.56	90.25			Y/F
4890.30	H	47.59	38.95	3.77	51.36	42.72	74.00	54.00	Y/H

Remark :

- (1) All readings are Peak unless otherwise stated QP in column of 『Note』 . Peak denotes that the Peak reading compliance with the QP Limits and then QP Mode measurement didn't perform .
- (2) Measuring frequency range from 30MHz to 1000MHz or the 10th harmonic of highest fundamental frequency .“F” denotes fundamental frequency; “H” denotes spurious frequency. “E” denotes band edge frequency. (This judgment method includes the Band Edge Requirement.)
- (3) Radiated emissions measured in frequency range above 1000MHz were made with an instrument using Peak detector mode and AV detector mode of the emission .
- (4) Data of measurement within this frequency range shown “ * ” in the table above means the reading of emissions are attenuated more than 20dB below the permissible limits or the field strength is too small to be measured.
- (5) A preamp and high pass filter were used for this test in order to provide sufficient measurement sensitivity.
- (6) EUT Orthogonal Axis :
“X” - denotes Laid on Table ; “Y” - denotes Vertical Stand ; “Z” - denotes Side Stand

TX CH09 (Above 1000 MHz, Horizontal)

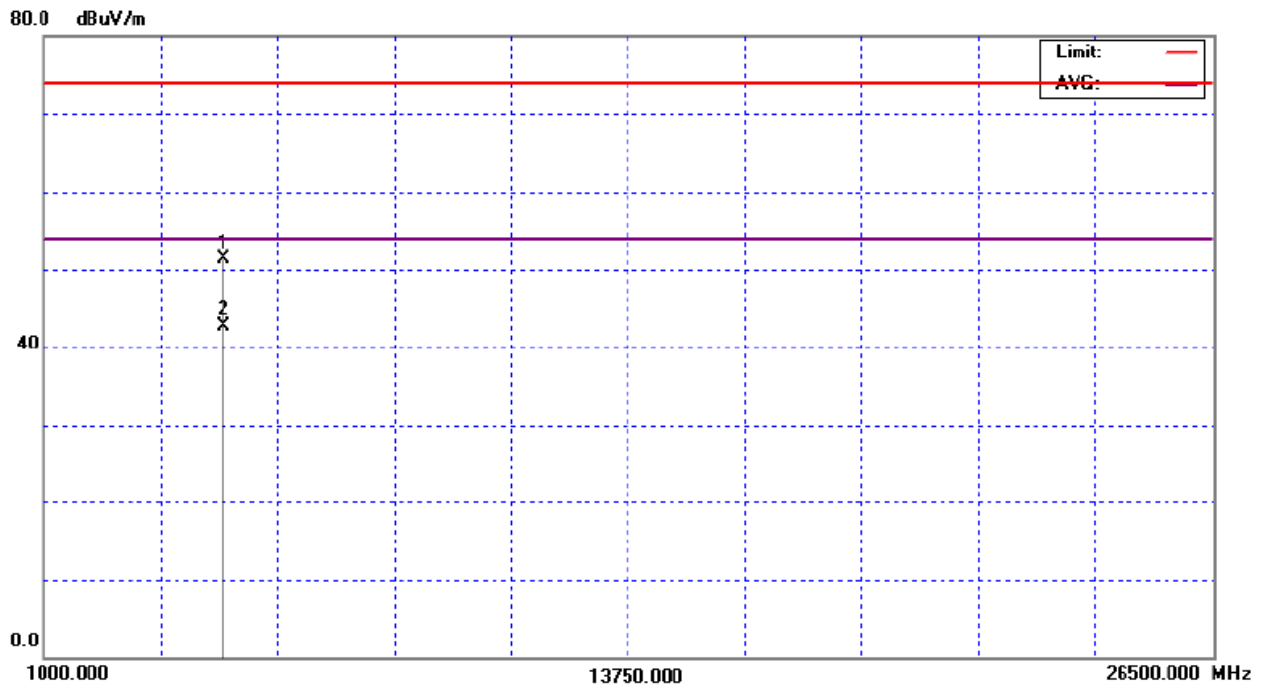
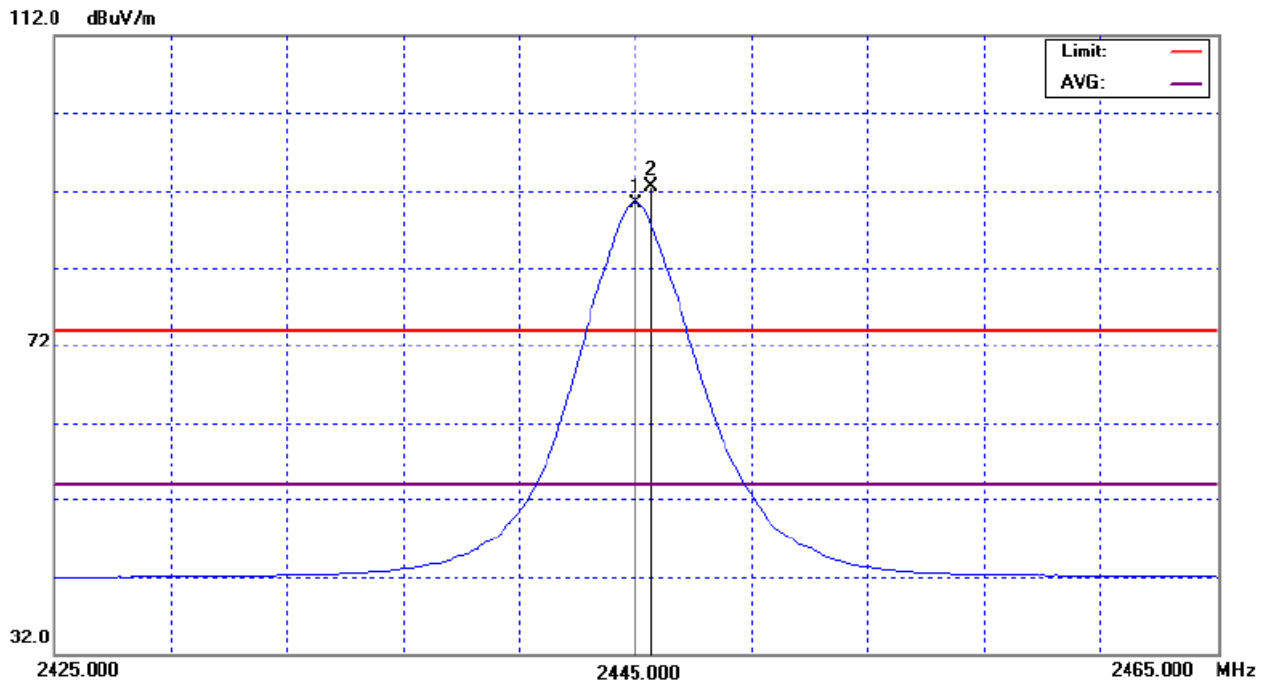

EUT :	Zigbee Module	Model No. :	EM2531
Temperature :	22 °C	Relative Humidity :	60%
Pressure :	1010 hPa	Test Voltage :	DC 4.5V
Test Mode :	TX 2480MHz –CH 16		

Freq.	Ant.Pol.	Reading		Ant./CF	Act.		Limit		Note
		Peak	AV		Peak	AV	Peak	AV	
(MHz)	H/V	(dBuV)	(dBuV)	CF(dB)	(dBuV/m)	(dBuV/m)	(dBuV/m)	(dBuV/m)	
2480.00	V	55.34	52.96	32.34	87.67	85.30			Y/F
2483.50	V	27.34	18.52	32.35	59.69	50.87	74.00	54.00	Y/E
4959.96	V	46.56	40.08	3.98	50.54	44.06	74.00	54.00	Y/H

Remark :

- (1) All readings are Peak unless otherwise stated QP in column of 『Note』 . Peak denotes that the Peak reading compliance with the QP Limits and then QP Mode measurement didn't perform .
- (2) Measuring frequency range from 30MHz to 1000MHz or the 10th harmonic of highest fundamental frequency .“F” denotes fundamental frequency; “H” denotes spurious frequency. “E” denotes band edge frequency. (This judgment method includes the Band Edge Requirement.)
- (3) Radiated emissions measured in frequency range above 1000MHz were made with an instrument using Peak detector mode and AV detector mode of the emission .
- (4) Data of measurement within this frequency range shown “ * ” in the table above means the reading of emissions are attenuated more than 20dB below the permissible limits or the field strength is too small to be measured.
- (5) A preamp and high pass filter were used for this test in order to provide sufficient measurement sensitivity.
- (6) EUT Orthogonal Axis :
“X” - denotes Laid on Table ; “Y” - denotes Vertical Stand ; “Z” - denotes Side Stand

TX CH16 (Above 1000 MHz, Vertical)

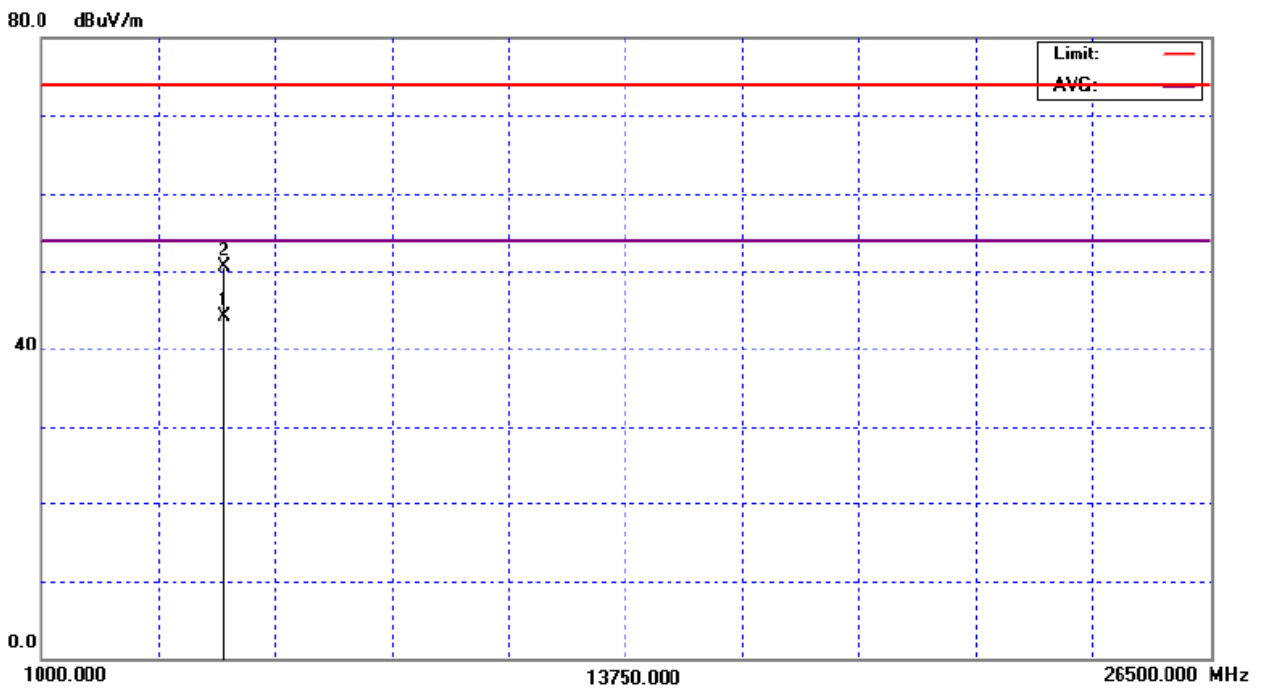
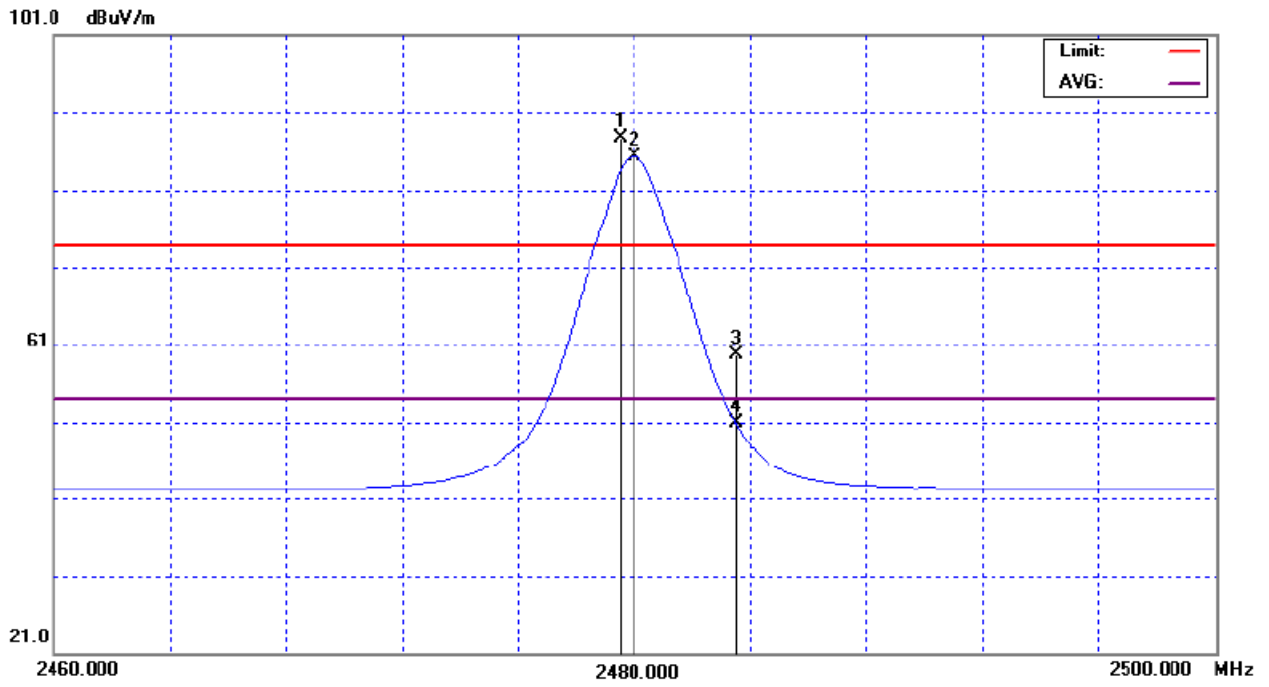

EUT :	Zigbee Module	Model No. :	EM2531
Temperature :	22 °C	Relative Humidity :	60%
Pressure :	1010 hPa	Test Voltage :	DC 4.5V
Test Mode :	TX 2480MHz - CH 16		

Freq.	Ant.Pol.	Reading		Ant./CF	Act.		Limit		Note
		Peak	AV		Peak	AV	Peak	AV	
(MHz)	H/V	(dBuV)	(dBuV)	CF(dB)	(dBuV/m)	(dBuV/m)	(dBuV/m)	(dBuV/m)	
2480.00	H	60.21	57.98	32.34	92.55	90.32			Y/F
2483.50	H	30.77	20.26	32.35	63.12	52.61	74.00	54.00	Y/E
4960.00	H	48.02	39.03	3.98	52.00	43.01	74.00	54.00	Y/H

Remark :

- (1) All readings are Peak unless otherwise stated QP in column of 『Note』 . Peak denotes that the Peak reading compliance with the QP Limits and then QP Mode measurement didn't perform .
- (2) Measuring frequency range from 30MHz to 1000MHz or the 10th harmonic of highest fundamental frequency . "F" denotes fundamental frequency; "H" denotes spurious frequency. "E" denotes band edge frequency. (This judgment method includes the Band Edge Requirement.)
- (3) Radiated emissions measured in frequency range above 1000MHz were made with an instrument using Peak detector mode and AV detector mode of the emission .
- (4) Data of measurement within this frequency range shown " * " in the table above means the reading of emissions are attenuated more than 20dB below the permissible limits or the field strength is too small to be measured.
- (5) A preamp and high pass filter were used for this test in order to provide sufficient measurement sensitivity.
- (6) EUT Orthogonal Axis :
 "X" - denotes Laid on Table ; "Y" - denotes Vertical Stand ; "Z" - denotes Side Stand

TX CH16 (Above 1000 MHz, Horizontal)

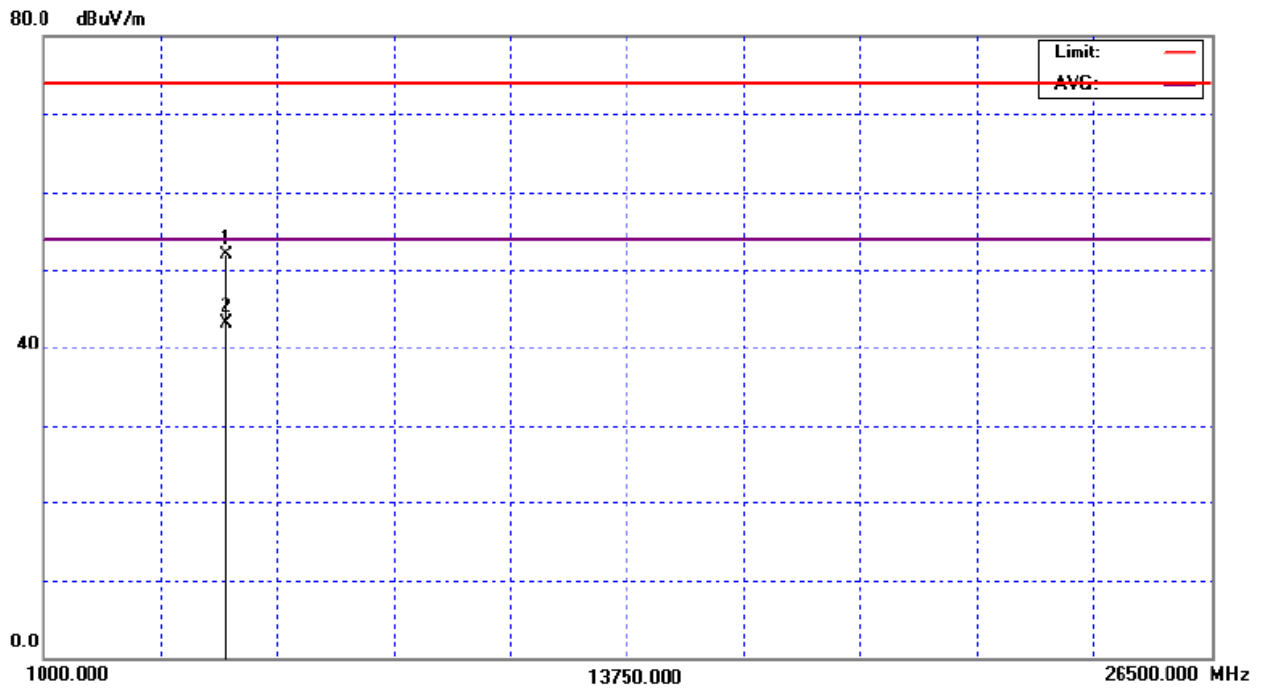
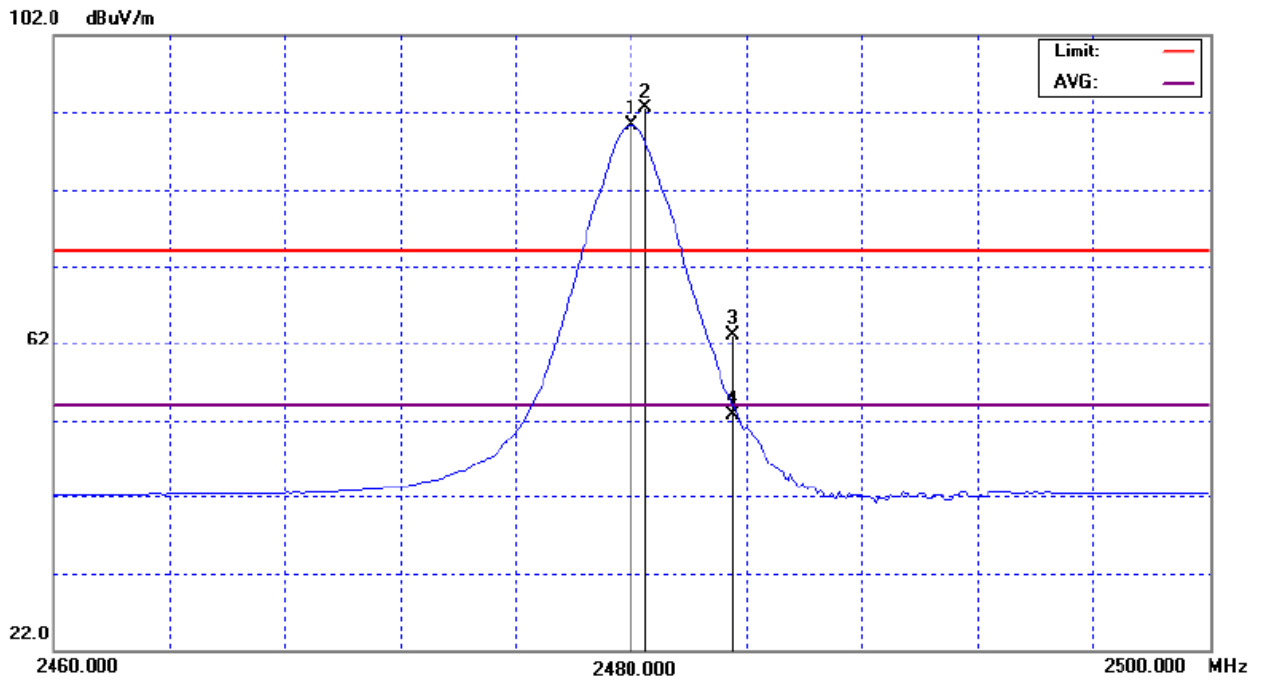

4.2.9 TEST RESULTS (RESTRICTED BANDS REQUIREMENTS)

EUT :	Zigbee Module	Model No. :	EM2531
Temperature :	22 °C	Relative Humidity :	60%
Pressure :	1010 hPa	Test Voltage :	DC 4.5V
Test Mode :	TX 2405MHz/2480MHz (Vertical)		
Note :	1. The transmitter was setup to transmit at the lowest channel (CH01). Then the field strength was measured at 2310-2390 MHz. 2. The transmitter was setup to transmit at the highest channel (CH16). Then the field strength was measured at 2483.5-2500 MHz.		

Freq. (MHz)	Ant.Pol. H/V	Reading		Ant./CF CF(dB)	Act.		Limit		Note
		Peak (dBuV)	AV (dBuV)		Peak (dBuV/m)	AV (dBuV/m)	Peak (dBuV/m)	AV (dBuV/m)	
2390.00	V	20.57	9.84	32.05	52.62	41.89	74.00	54.00	CH01
2483.50	V	27.34	18.52	32.35	59.69	50.87	74.00	54.00	CH16

Remark :

- (1) Radiated emissions measured in frequency range above 1000MHz were made with an instrument using Peak detector mode and AV detector mode of the emission .
- (2) EUT Orthogonal Axis :
 "X" - denotes Laid on Table ; "Y" - denotes Vertical Stand ; "Z" - denotes Side Stand

Restricted Bands Requirements, Vertical
CH01

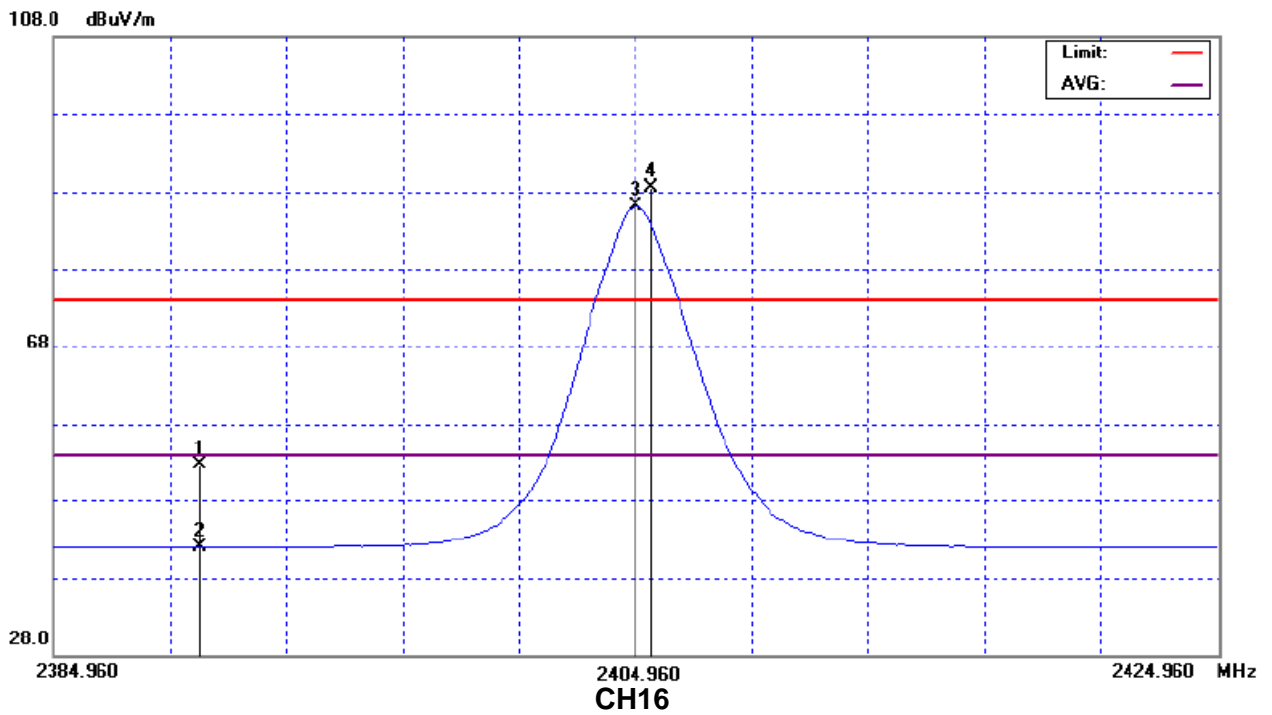

CH16

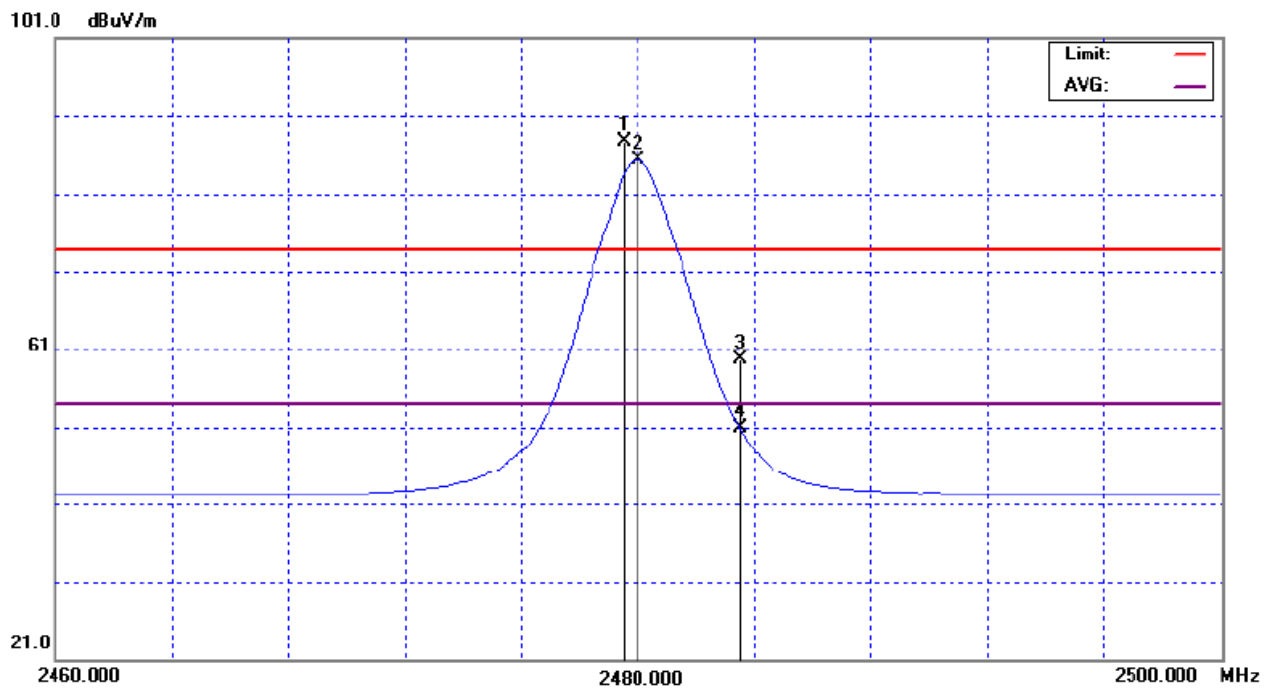

EUT :	Zigbee Module	Model No. :	EM2531
Temperature :	22 °C	Relative Humidity :	60%
Pressure :	1010 hPa	Test Voltage :	DC 4.5V
Test Mode :	TX 2405MHz/2480MHz (Horizontal)		
Note :	1. The transmitter was setup to transmit at the lowest channel (CH01). Then the field strength was measured at 2310-2390 MHz. 2. The transmitter was setup to transmit at the highest channel (CH16). Then the field strength was measured at 2483.5-2500 MHz.		

Freq.	Ant.Pol.	Reading		Ant./CF	Act.		Limit		Note
		Peak	AV		Peak	AV	Peak	AV	
(MHz)	H/V	(dBuV)	(dBuV)	CF(dB)	(dBuV/m)	(dBuV/m)	(dBuV/m)	(dBuV/m)	
2390.00	H	21.96	9.87	32.05	54.01	41.92	74.00	54.00	CH01
2483.50	H	30.77	20.26	32.35	63.12	52.61	74.00	54.00	CH16

Remark :

- (1) Radiated emissions measured in frequency range above 1000MHz were made with an instrument using Peak detector mode and AV detector mode of the emission .
- (2) EUT Orthogonal Axis :
 "X" - denotes Laid on Table ; "Y" - denotes Vertical Stand ; "Z" - denotes Side Stand

Restricted Bands Requirements, Horizontal
CH01

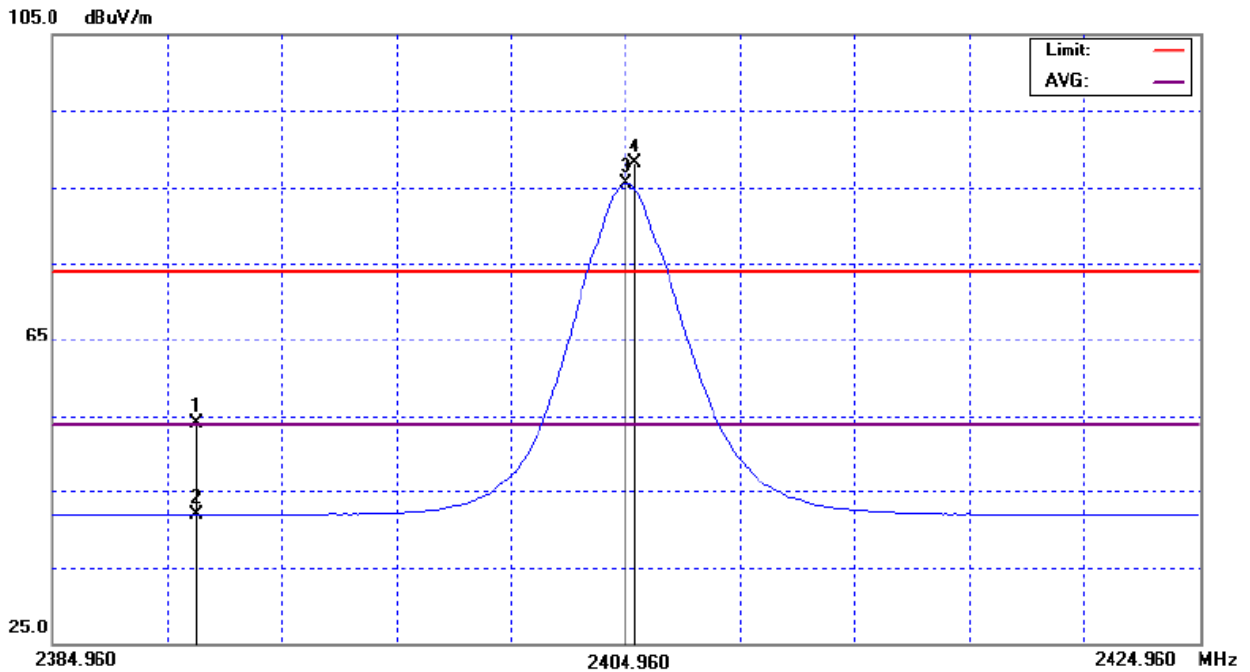

CH16

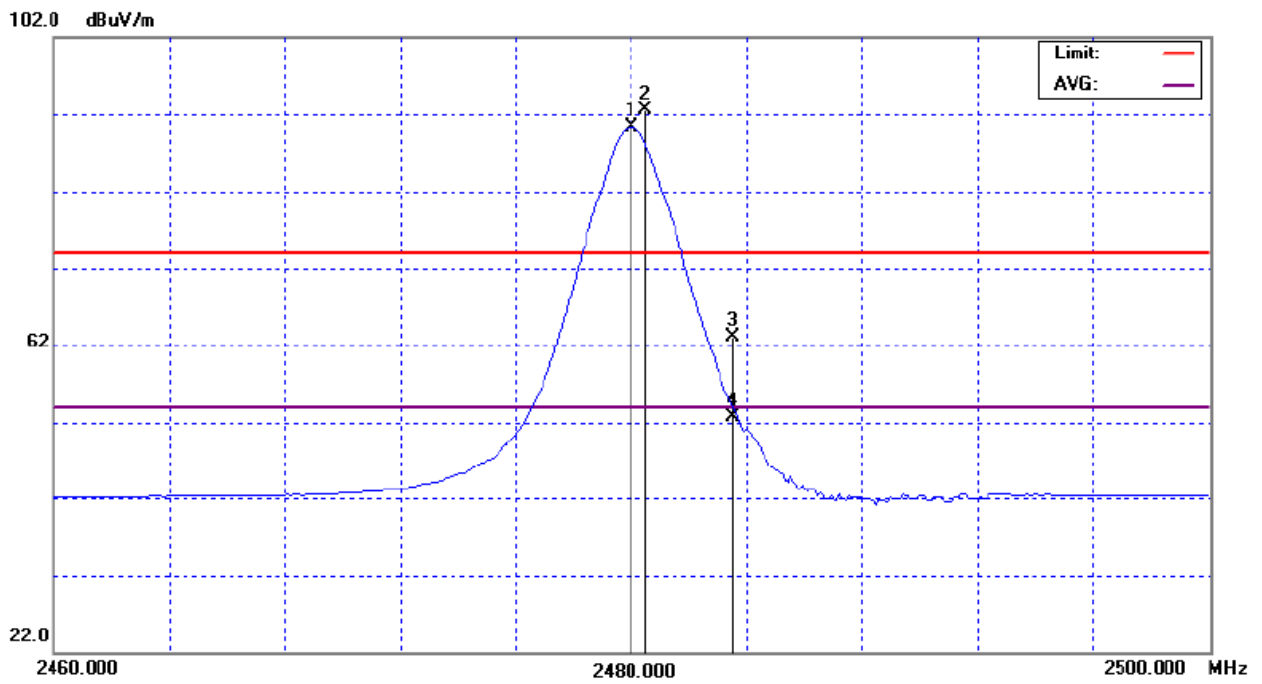

5. BANDWIDTH TEST

5.1 Applied procedures / limit

FCC Part15 (15.247) , Subpart C				
Section	Test Item	Limit	Frequency Range (MHz)	Result
15.247 (a)(2)	Bandwidth	>= 500KHz (6dB bandwidth)	2400-2483.5	PASS

5.1.1 MEASUREMENT INSTRUMENTS LIST

Item	Kind of Equipment	Manufacturer	Type No.	Serial No.	Calibrated until
1	Spectrum Analyzer	R&S	FSP_40	100129	Jan. 08, 2008

Remark: " N/A" denotes No Model No. , Serial No. or No Calibration specified.

5.1.2 TEST PROCEDURE

- a. The EUT was directly connected to the spectrum analyzer and antenna output port as show in the block diagram below,
- b. Spectrum Setting : RBW= 100KHz, VBW=100KHz, Sweep time = 20 ms.

5.1.3 DEVIATION FROM STANDARD

No deviation.

5.1.4 TEST SETUP

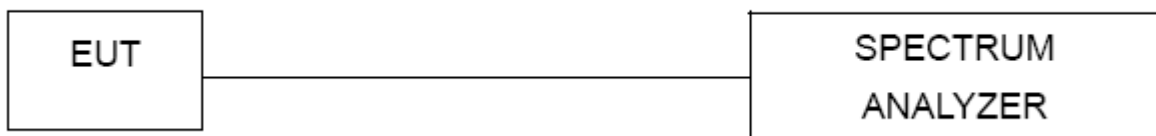

5.1.5 EUT OPERATION CONDITIONS

The EUT tested system was configured as the statements of 4.1.6 Unless otherwise a special operating condition is specified in the follows during the testing.

5.1.6 TEST RESULTS

EUT :	Zigbee Module	Model No. :	EM2531
Temperature :	23 °C	Relative Humidity :	58 %
Pressure :	1004 hPa	Test Power :	DC 4.5V
Test Mode :	Zigbee mode /CH01, CH09, CH16		

Test Channel	Frequency (MHz)	Bandwidth (MHz)	99% Occupied BW (MHz)	LIMIT (MHz)
CH01	2405	1.61	2.42	>=500KHz
CH09	2445	1.59	2.37	>=500KHz
CH16	2480	1.57	2.33	>=500KHz

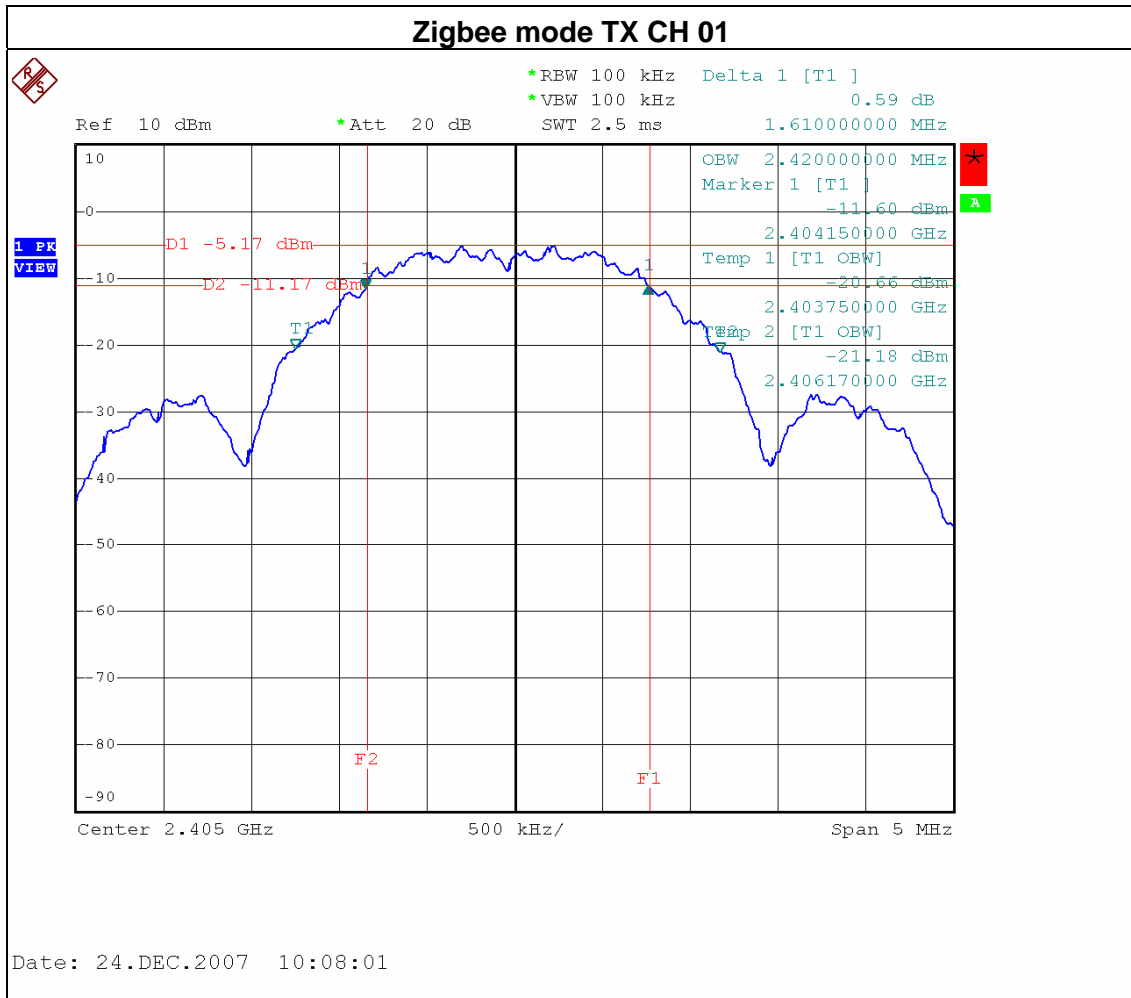

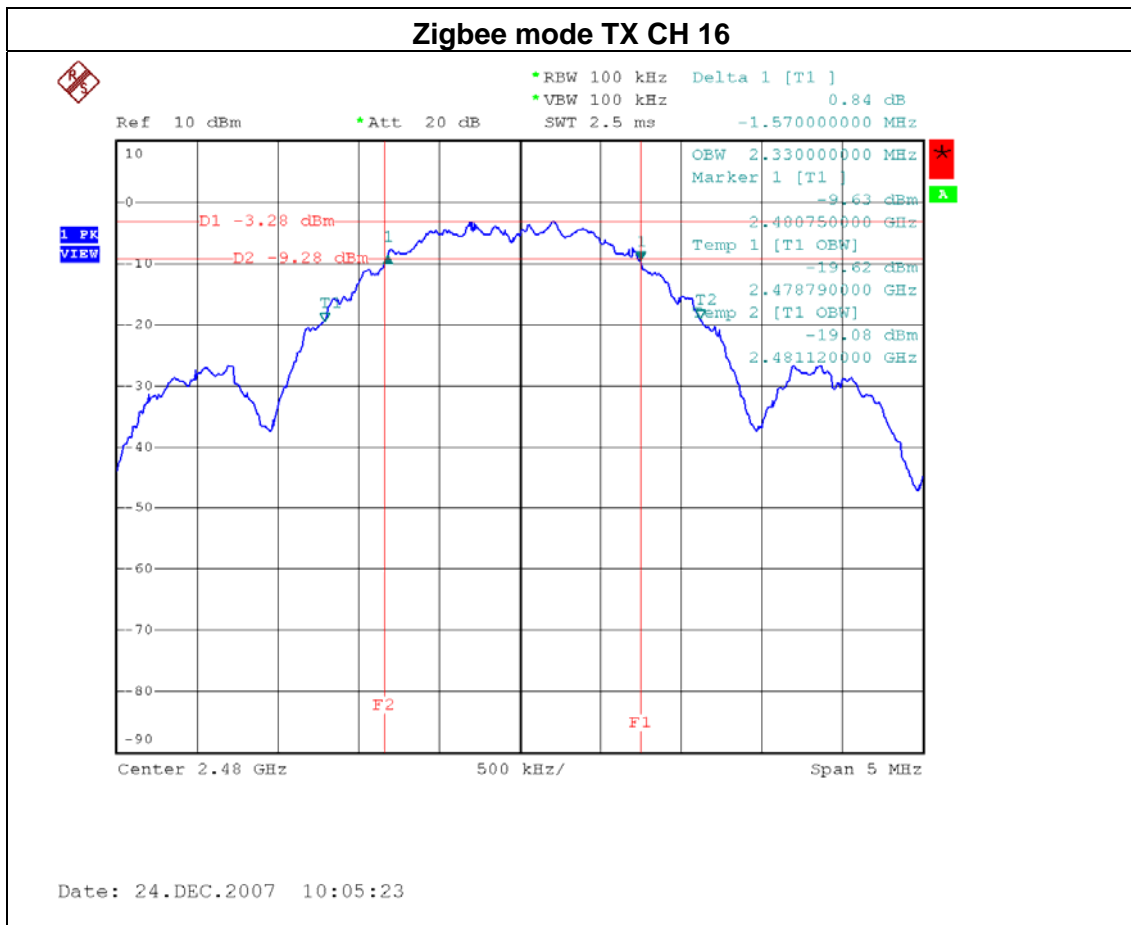
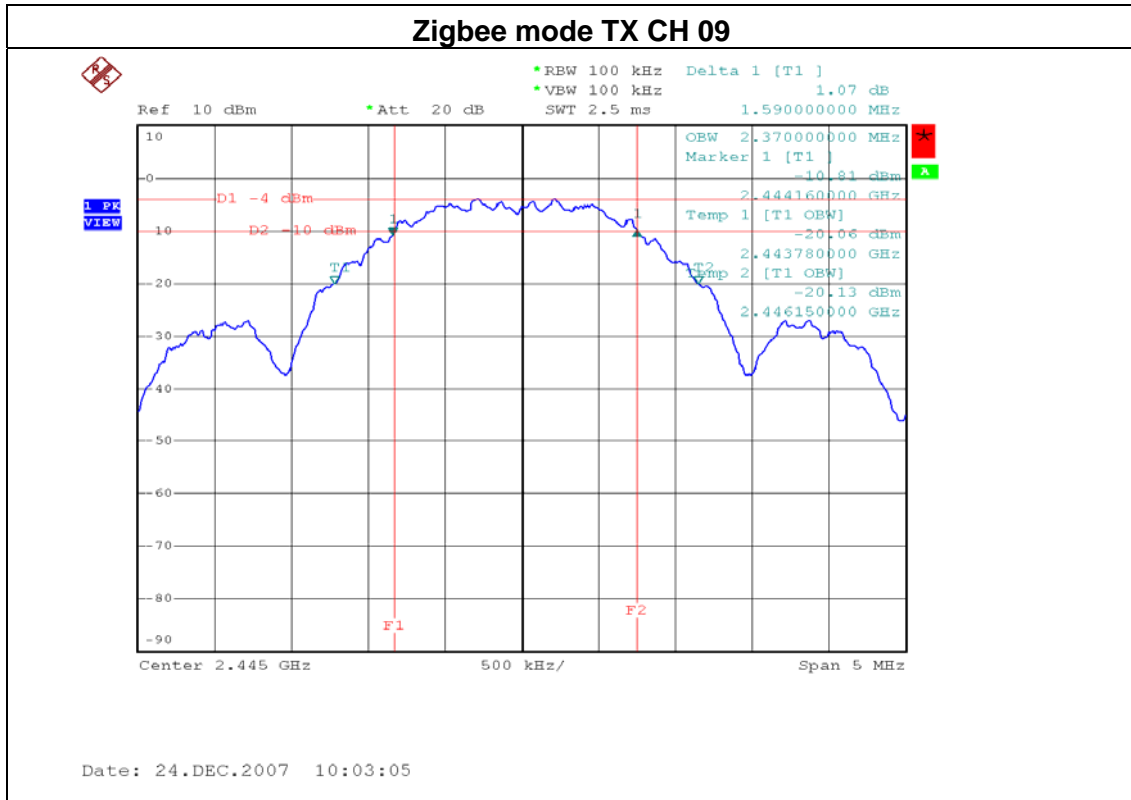

6. PEAK OUTPUT POWER TEST

6.1 Applied procedures / limit

FCC Part15 (15.247) , Subpart C				
Section	Test Item	Limit	Frequency Range (MHz)	Result
15.247 (b)(1)	Peak Output Power	1 watt or 30dBm	2400-2483.5	PASS

6.1.1 MEASUREMENT INSTRUMENTS LIST

Item	Kind of Equipment	Manufacturer	Type No.	Serial No.	Calibrated until
1	Power Meter	Anritsu	ML2487A	6K00001568	Oct. 27, 2008
2	Power Meter Sensor	Anritsu	MA2491A	030989	Feb. 11, 2008

Remark: " N/A" denotes No Model No. , Serial No. or No Calibration specified.

6.1.2 TEST PROCEDURE

- a. The EUT was directly connected to the spectrum analyzer and antenna output port as show in the block diagram below,
- b. Spectrum Setting : RBW= 3MHz, VBW= 3MHz, Sweep time = 20 ms.

6.1.3 DEVIATION FROM STANDARD

No deviation.

6.1.4 TEST SETUP

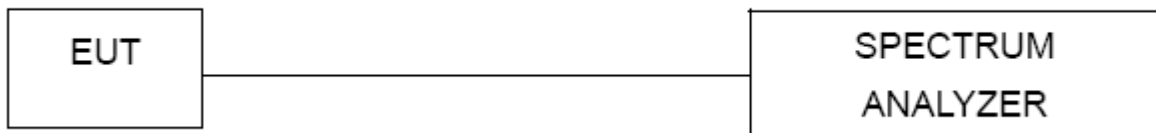

6.1.5 EUT OPERATION CONDITIONS

The EUT tested system was configured as the statements of 4.1.6 Unless otherwise a special operating condition is specified in the follows during the testing.

6.1.6 TEST RESULTS

EUT :	Zigbee Module	Model No. :	EM2531
Temperature :	23 °C	Relative Humidity :	58 %
Pressure :	1004 hPa	Test Power :	DC 4.5V
Test Mode :	Zigbee mode /CH01, CH09, CH16		

Test Channel	Frequency (MHz)	Peak Output Power (dBm)	LIMIT (dBm)	LIMIT (W)
CH01	2405	-1.42	30	1
CH09	2445	-0.47	30	1
CH16	2480	0.07	30	1

7. ANTENNA CONDUCTED SPURIOUS EMISSION

7.1 Applied procedures / limit

20dBc in any 100 kHz bandwidth outside the operating frequency band. In case the emission fall within the restricted band specified on 15.205(a), then the 15.209(a) limit in the table below has to be followed.

Frequencies (MHz)	Field Strength (micovolts/meter)	Measurement Distance (meters)
0.009~0.490	2400/F(KHz)	300
0.490~1.705	24000/F(KHz)	30
1.705~30.0	30	30
30~88	100	3
88~216	150	3
216~960	200	3
Above 960	500	3

7.1.1 MEASUREMENT INSTRUMENTS LIST

Item	Kind of Equipment	Manufacturer	Type No.	Serial No.	Calibrated until
1	Spectrum Analyzer	R&S	FSP_40	100129	Jan. 08, 2008

Remark: " N/A" denotes No Model No. , Serial No. or No Calibration specified.

The following table is the setting of the spectrum analyzer.

Spectrum Parameter	Setting
Attenuation	Auto
Span Frequency	100 MHz
RB / VB (emission in restricted band)	1MHz / 1MHz for Peak, 1 MHz / 10Hz for Average
RB / VB (other emission)	100 KHz /100 KHz for Peak

7.1.2 TEST PROCEDURE

- a. The EUT was directly connected to the spectrum analyzer and antenna output port as show in the block diagram below,
- b. Spectrum Setting : RBW= 100KHz, VBW=100KHz, Sweep time = 200 ms.

7.1.3 DEVIATION FROM STANDARD

No deviation.

7.1.4 TEST SETUP



7.1.5 EUT OPERATION CONDITIONS

The EUT tested system was configured as the statements of 4.1.6 Unless otherwise a special operating condition is specified in the follows during the testing.

7.1.6 TEST RESULTS

EUT :	Zigbee Module	Model No. :	EM2531
Temperature :	23 °C	Relative Humidity :	58 %
Pressure :	1004 hPa	Test Power :	DC 4.5V
Test Mode :	Zigbee mode CH01, CH16		

Channel of Worst Data: CH16			
The max. radio frequency power in any 100kHz bandwidth outside the frequency band		The max. radio frequency power in any 100 kHz bandwidth within the frequency band.	
FREQUENCY(MHz)	POWER(dBm)	FREQUENCY(MHz)	POWER(dBm)
2384.0	-58.07	2483.80	-40.01
Result			
In any 100kHz bandwidth outside the frequency band, the radio frequency power is at least 20dB below that in the 100kHz bandwidth within the band that contains the highest level of the desired power.			

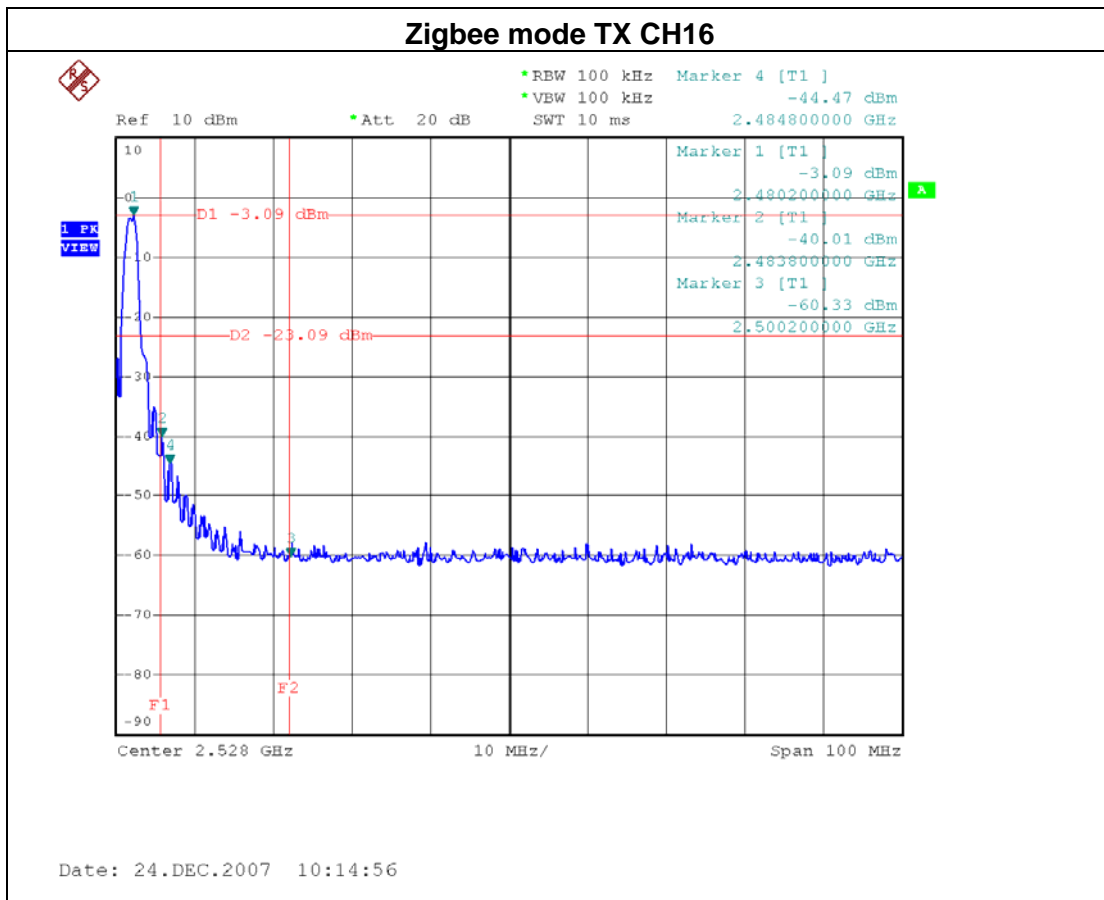
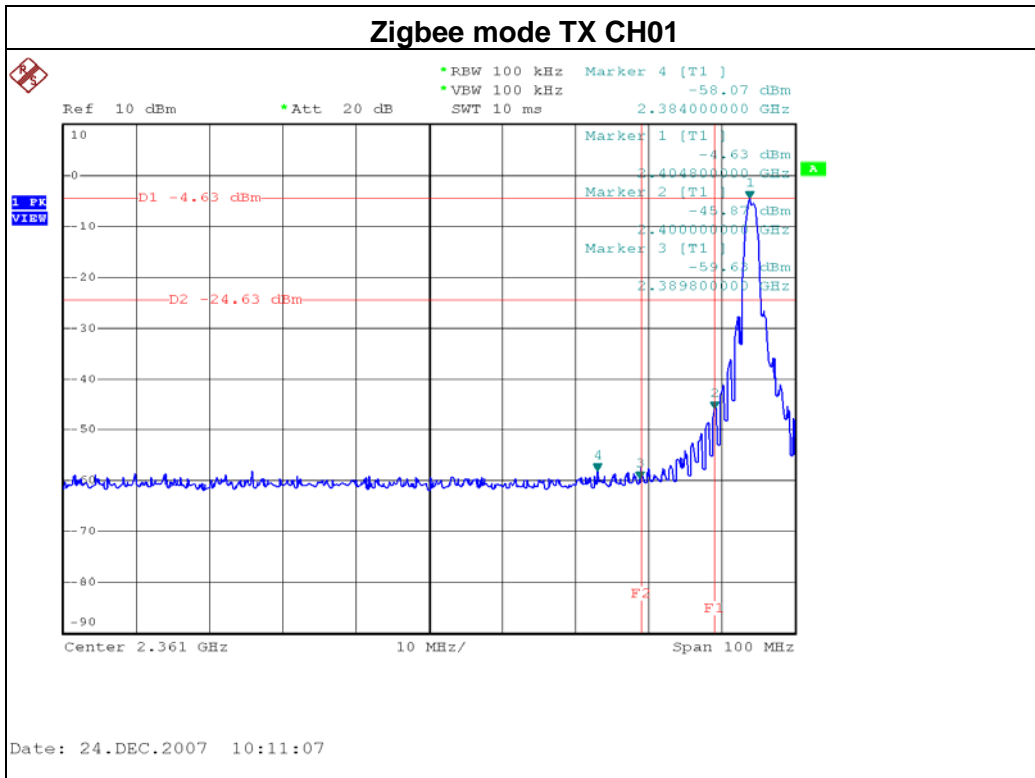

8. POWER SPECTRAL DENSITY TEST

8.1 Applied procedures / limit

FCC Part15 (15.247) , Subpart C				
Section	Test Item	Limit	Frequency Range (MHz)	Result
15.247 (d)	Power Spectral Density	8 dBm (in any 3KHz)	2400-2483.5	PASS

8.1.1 MEASUREMENT INSTRUMENTS LIST

Item	Kind of Equipment	Manufacturer	Type No.	Serial No.	Calibrated until
1	Spectrum Analyzer	R&S	FSP_40	100129	Jan. 08, 2008

Remark: " N/A" denotes No Model No. , Serial No. or No Calibration specified.

8.1.2 TEST PROCEDURE

- a. The EUT was directly connected to the spectrum analyzer and antenna output port as show in the block diagram below,
- b. Spectrum Setting : RBW=3KHz, VBW=30 KHz, Sweep time = 500s.

8.1.3 DEVIATION FROM STANDARD

No deviation.

8.1.4 TEST SETUP

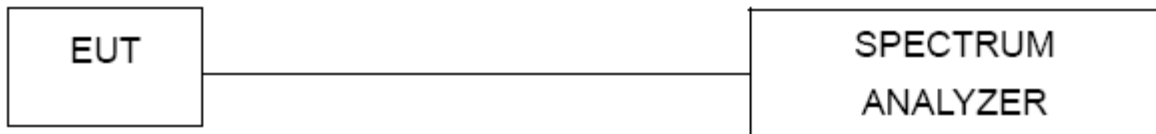

8.1.5 EUT OPERATION CONDITIONS

The EUT tested system was configured as the statements of 4.1.6 Unless otherwise a special operating condition is specified in the follows during the testing.

8.1.6 TEST RESULTS

EUT :	Zigbee Module	Model No. :	EM2531
Temperature :	23 °C	Relative Humidity :	58 %
Pressure :	1004 hPa	Test Power :	DC 4.5V
Test Mode :	Zigbee mode /CH01, CH09, CH16		

Test Channel	Frequency (MHz)	Peak Output Power (dBm)	LIMIT (dBm)
CH01	2405	-16.41	8
CH09	2445	-15.60	8
CH16	2480	-13.48	8

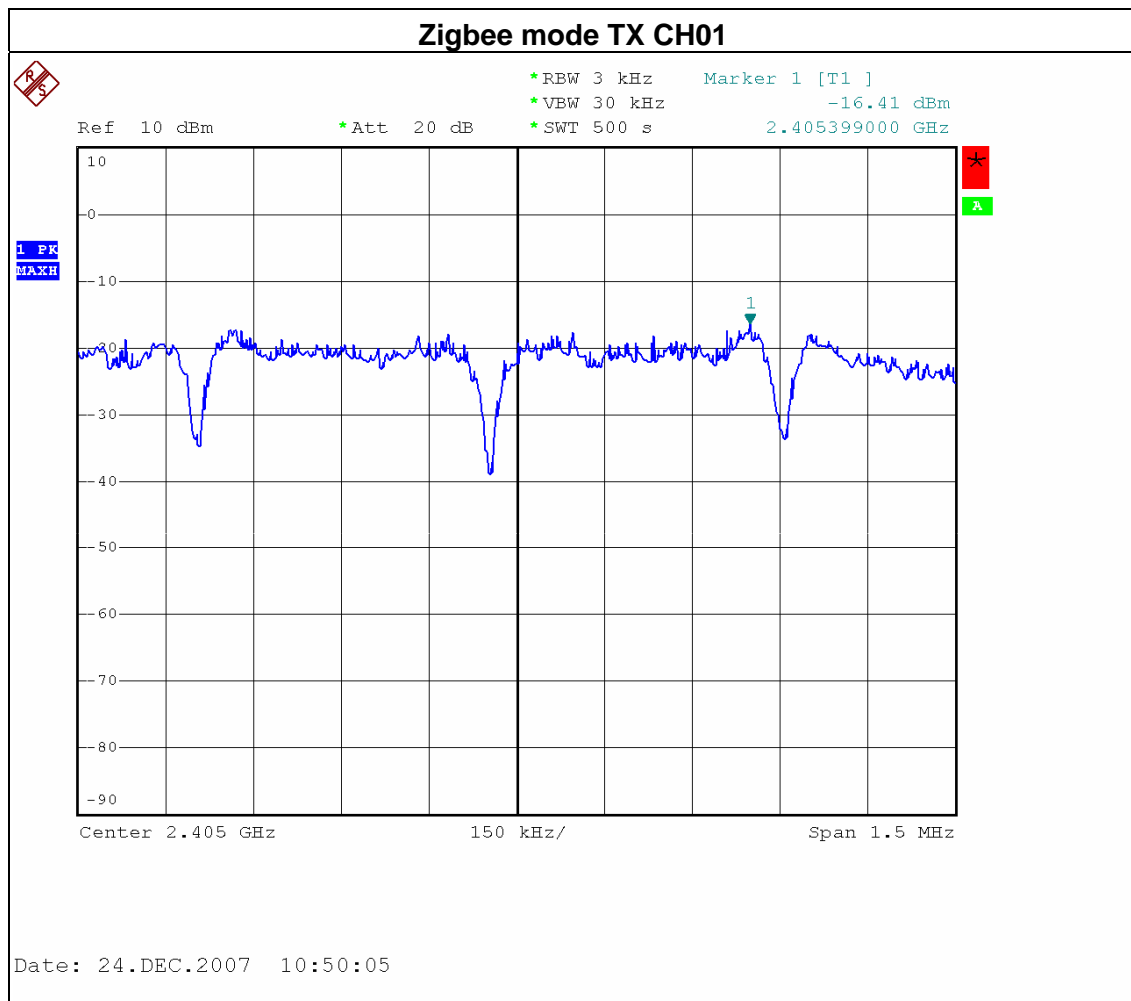

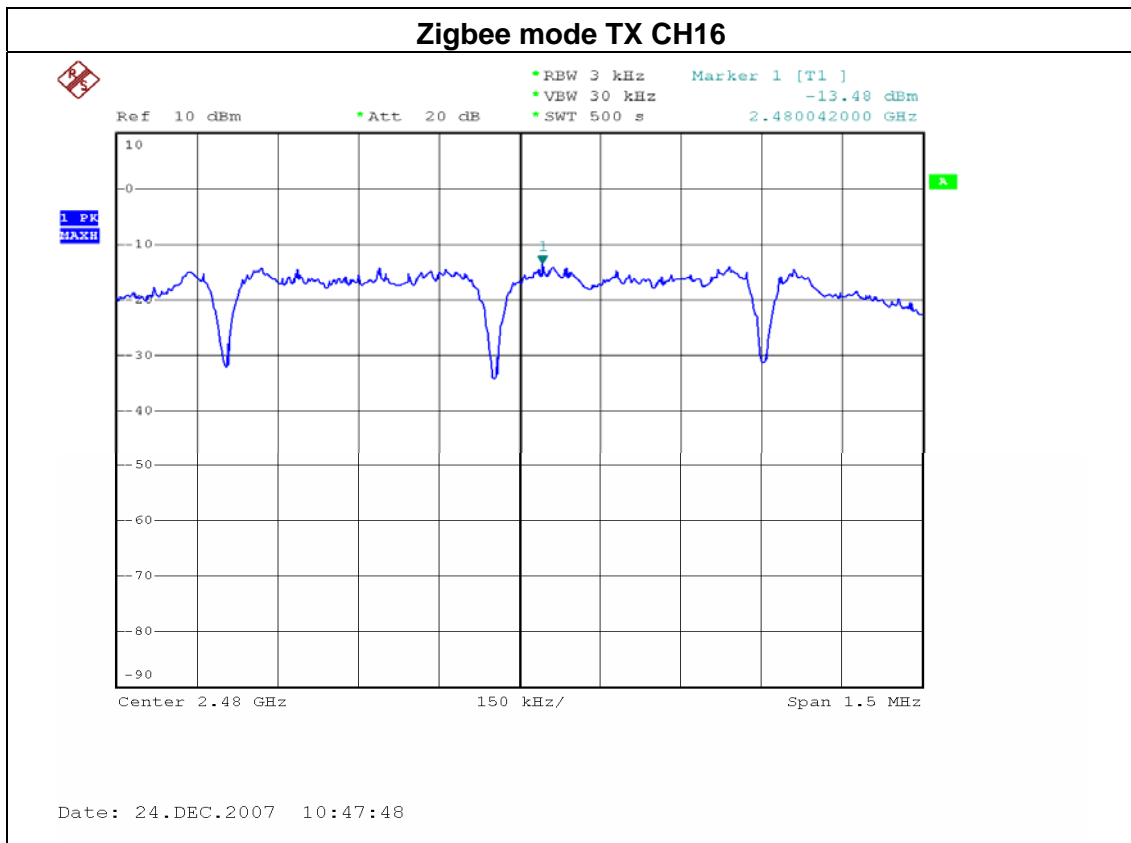
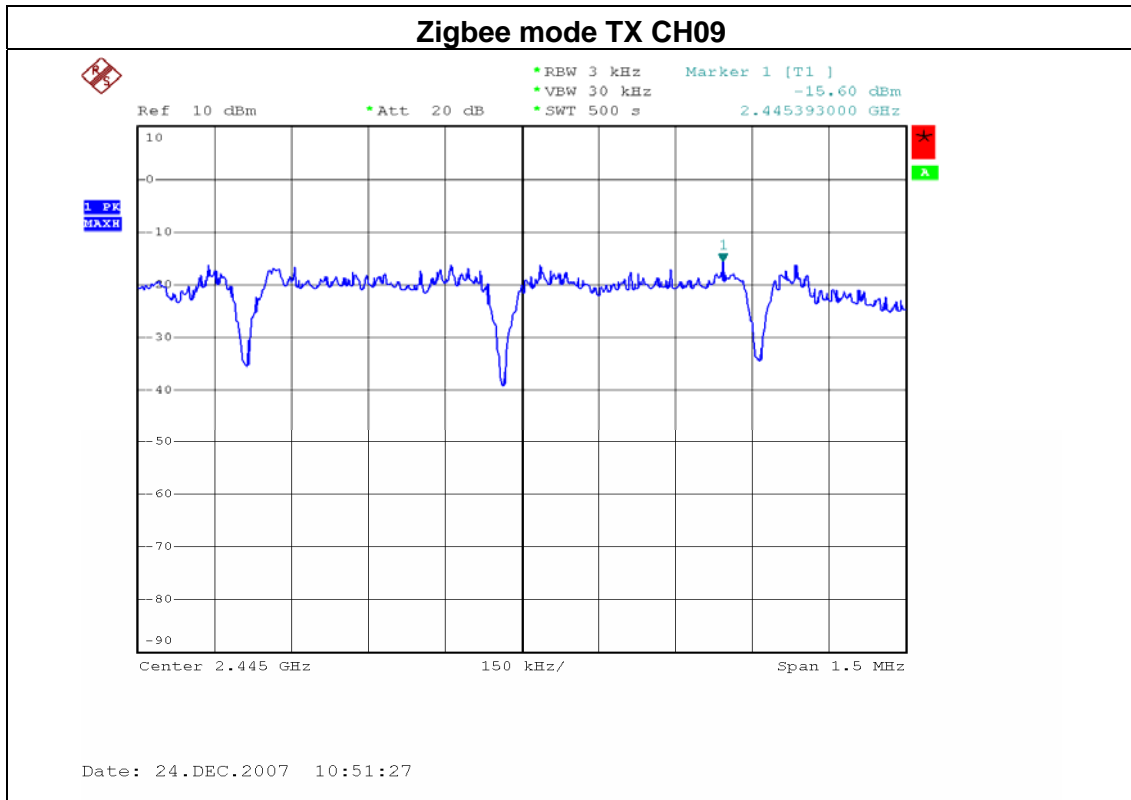

9. RF EXPOSURE TEST

9.1 APPLIED PROCEDURES / LIMIT

Systems operating under the provisions of this section shall be operated in a manner that ensures that the public is not exposed to radio frequency energy levels in excess limit for maximum permissible exposure. In accordance with 47 CFR FCC Part 2 Subpart J, section 2.1091 this device has been defined as a mobile device whereby a distance of 0.2 m normally can be maintained between the user and the device.

(A) Limits for Occupational / Controlled Exposure

Frequency Range (MHz)	Electric Field Strength (E) (V/m)	Magnetic Field Strength (H) (A/m)	Power Density (S) (mW/ cm ²)	Averaging Time E ² , H ² or S (minutes)
0.3-3.0	614	1.63	(100)*	6
3.0-30	1842 / f	4.89 / f	(900 / f)*	6
30-300	61.4	0.163	1.0	6
300-1500			F/300	6
1500-100,000			5	6

(B) Limits for General Population / Uncontrolled Exposure

Frequency Range (MHz)	Electric Field Strength (E) (V/m)	Magnetic Field Strength (H) (A/m)	Power Density (S) (mW/ cm ²)	Averaging Time E ² , H ² or S (minutes)
0.3-1.34	614	1.63	(100)*	30
1.34-30	824/f	2.19/f	(180/f)*	30
30-300	27.5	0.073	0.2	30
300-1500			F/1500	30
1500-100,000			1.0	30

Note: f = frequency in MHz ; *Plane-wave equivalent power density

9.1.1 MEASUREMENT INSTRUMENTS LIST

Item	Kind of Equipment	Manufacturer	Type No.	Serial No.	Calibrated until
1	Spectrum Analyzer	R&S	FSP_40	100129	Jan. 08, 2008

Remark: " N/A" denotes No Model Name , Serial No. or No Calibration specified.

9.1.2 MPE CALCULATION METHOD

$$E \text{ (V/m)} = \frac{\sqrt{30 \times P \times G}}{d} \qquad \text{Power Density: } Pd \text{ (W/m}^2\text{)} = \frac{E^2}{377}$$

E = Electric field (V/m)

P = Peak RF output power (W)

G = EUT Antenna numeric gain (numeric)

d = Separation distance between radiator and human body (m)

The formula can be changed to

$$Pd = \frac{30 \times P \times G}{377 \times d^2}$$

From the peak EUT RF output power, the minimum mobile separation distance, d=0.2m, as well as the gain of the used antenna, the RF power density can be obtained

9.1.3 DEVIATION FROM STANDARD

No deviation.

9.1.4 TEST SETUP**9.1.5 EUT OPERATION CONDITIONS**

The EUT tested system was configured as the statements of 4.1.6 Unless otherwise a special operating condition is specified in the follows during the testing.

9.1.6 TEST RESULTS

EUT :	Zigbee Module	Model No. :	EM2531
Temperature :	23°C	Relative Humidity :	58 %
Pressure :	1012 hPa	Test Voltage :	DC 4.5V
Test Mode :	Zigbee mode CH01, CH09, CH16		

Antenna Gain (dBi)	Antenna Gain (numeric)	Peak Output Power (dBm)	Peak Output Power (mW)	Power Density (S) (mW/cm ²)	Limit of Power Density (S) (mW/cm ²)	Test Result
1.00	1.2589	-1.42	0.7211	0.000181	1	Complies
1.00	1.2589	-0.47	0.8974	0.000225	1	Complies
1.00	1.2589	0.07	1.0162	0.000255	1	Complies

10. EUT TEST PHOTO

Conducted Measurement Photos

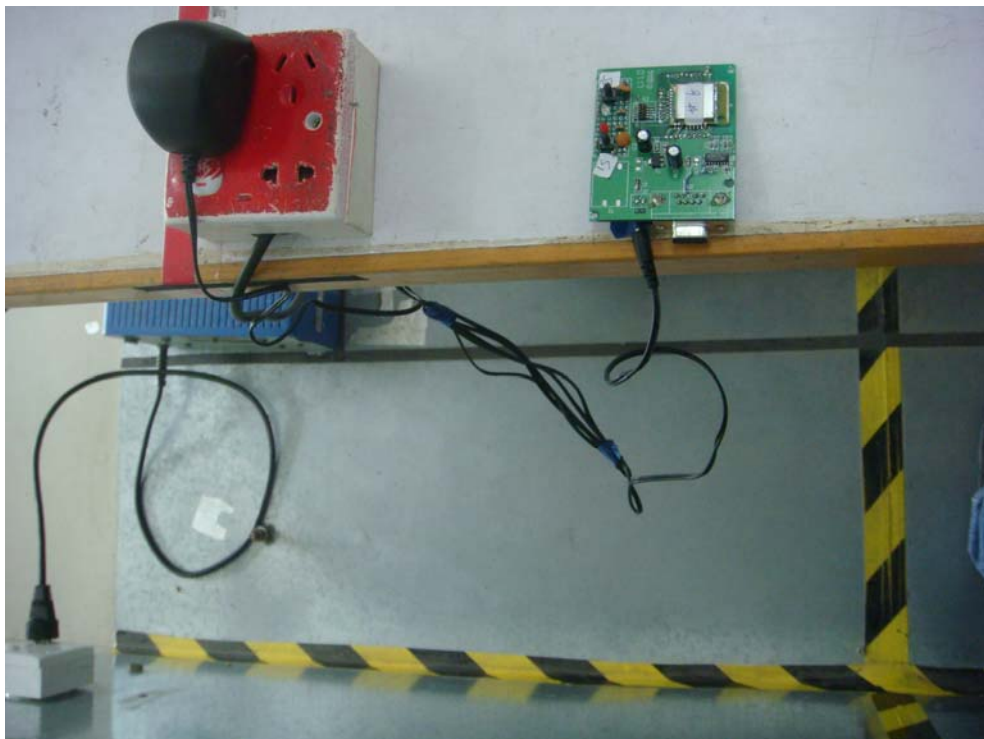

Radiated Measurement Photos



Radiated Measurement Photos

