



**8188RF**

**Wireless Smart Office Keyboard & Mouse Kit**

**User's Guide**

**Version 1.0**

Created August 29, 2002



The information in this document is subject to change without notice and does not represent a commitment on the part of the vendor.

No warranty of representation, either expressed or implied, is made with respect to the quality, accuracy or fitness for any particular purpose of this document. The manufacturer reserves the right to make changes to the content of this document and/or the products associated with it at any time without obligation to notify any person or organisation of such changes.

In no event will the manufacturer be liable for direct, indirect, special, incidental or consequential damages arising out of the use or inability to use this product or documentation, even if advised of the possibility of such damages.

Copyright © 2002. All rights reserved

IBM, PC/AT and PS/2 are registered trademarks of International Business Machines Corporation.

Microsoft, Windows, and Windows NT are registered trademarks of Microsoft Corporation in the United States of America and/or other countries.

All other trademarks are trademarks of their respective holders.





## Table of Contents

1	<a href="#">Introduction</a> .....	1
	<a href="#">What's in this package</a> .....	1
2	<a href="#">System Requirements</a> .....	3
3	<a href="#">Hardware Installation</a> .....	4
4	<a href="#">Software Installation</a> .....	9
5	<a href="#">Uninstallation</a> .....	10
6	<a href="#">Smart Office Keyboard Driver</a> .....	11
	<a href="#">6.1 To Pop Up "KeyMaestro" Dialogue Box</a> .....	11
	<a href="#">6.2 To Pop Up "Configure Button" Dialogue Box</a> .....	13
7	<a href="#">Using the Keyboard</a> .....	15
	<a href="#">7.1 Office Application Keys Block</a> .....	15
	<a href="#">7.2 Internet Keys Block</a> .....	15
	<a href="#">7.3 Application Keys Block</a> .....	15
	<a href="#">7.4 Multimedia Keys Block</a> .....	17
	<a href="#">7.5 Enhanced Function Keys Block</a> .....	17
	<a href="#">7.6 Clipboard Keys Block</a> .....	20
8	<a href="#">Using the Mouse</a> .....	23
	<a href="#">8.1 Using the Mouse Driver</a> .....	23
	<a href="#">8.2 The Definition of Mouse Extra Function:</a> .....	25
	<a href="#">8.3 Quick Jump Function Introduction</a> .....	26
9	<a href="#">Troubleshooting</a> .....	28







# 1 Introduction

Congratulations on your purchase of the wireless USB smart Office keyboard and mouse kit! This keyboard and mouse kit will finally free you of the constraints of your desktop by providing a wireless connection between the keyboard or mouse and your PC. Pass around the keyboard or mouse during meetings without having to bother about a cable blocking your way or write e-mails and surf the Internet from the comfort of your living room couch!

The wireless smart Office keyboard and mouse kit consists of a keyboard, a mouse and a receiver. The whole keyboard is divided into 6 blocks except the normal keyboard function block. The 6 blocks are Office Application Keys block, Enhanced Function Key block, Internet Keys block, Application Keys block, Multimedia Keys block and Clipboard Keys block. These keys make your keyboard more powerful than ever. The applications and functions you use everyday are included in these blocks; just by a touch you can access to applications immediately. It helps a lot in your daily usage. Beside, the wireless mouse uses an optical sensor instead of mouse ball. The precise sensor detects motion on hundreds of surfaces, including wood, plastic, or even your pants leg, and prevents you from the interference caused by dust.

The most creative design of this Smart Office Keyboard is to use the build-in Office & clipboard hot keys, and the scroll wheel on the keyboard to help you saving hands-movement between keyboard and mouse and this saves your time. We want to make your typing time more fast, comfortable and joyful.

The Smart Office Keyboard is compatible with Windows® 98, Windows® 2000, Windows® ME and Windows® XP.

With Smart Office Keyboard, the work you do all the time takes less time.

In order to enjoy the full potential of the Smart Office Keyboard, please read this manual carefully.

## **What's in this package**

- ◆ A wireless smart Office keyboard
- ◆ A wireless mouse
- ◆ A receiver





- ◆ A driver disc
- ◆ Batteries (4pcs of AA alkaline batteries)





## 2 System Requirements

- ◆ Microsoft® Windows® 98, Windows® ME, Windows® 2000 or Windows® XP operating system
- ◆ Microsoft® Internet Explorer 5.0 or later version (for the Internet keys)
- ◆ CD-ROM or DVD drive (for CD or Video operation)
- ◆ Standard sound card (for CD or Video operation)
- ◆ USB port
- ◆ Microsoft® Office 97 or later version (for Office Application keys and Enhanced Function keys)
- ◆ The system supporting ACPI or APM II (for power management buttons)
- ◆ ATX mother board and ATX power supply (for power management buttons)





### 3 Hardware Installation

#### Slide Switch Setting

Step 1: Make sure your PC is switched off.

Step 2: Take the **receiver** and select channel CH1 or CH2 by using the slide switch on the back of the receiver. (**Remember your selection.**)

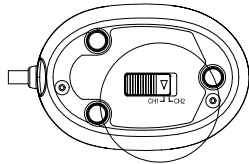

Bottom View of

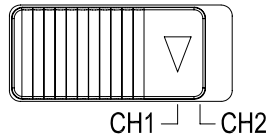

Slide Switch Setting of Receiver

Step 3: Connect the **receiver** to your PC by plugging in the receiver's USB connector into your PC.

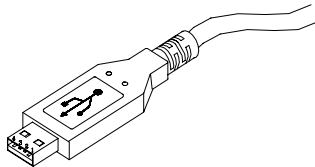

USB Connector

Step 4: Take the **keyboard** and make sure the batteries on the back are installed correctly. (Follow the polarity signs in the battery compartment.)





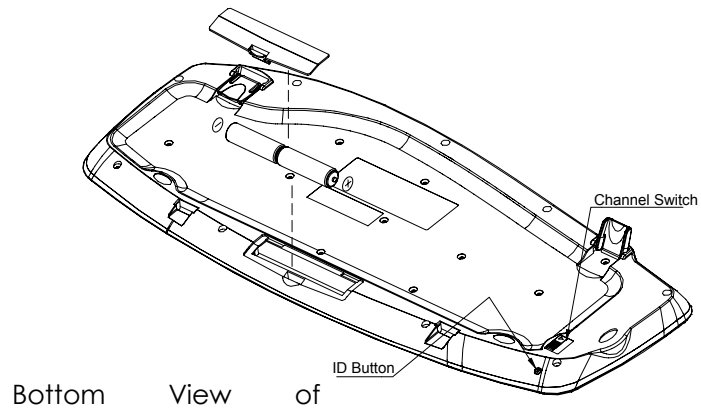



**Step 5:** Use the slide switch on the back of the **keyboard** to select the same channel as the one selected in step 2 on the receiver.

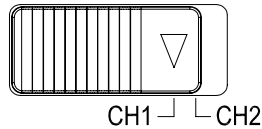

Slide Switch Setting

**Step 6:** Take the **mouse** and make sure the batteries on the back are installed correctly. (Follow the polarity signs in the battery compartment.)

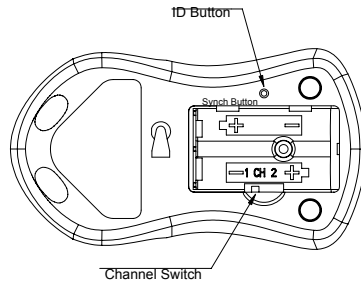

Bottom View of

**Step 7:** Use the slide switch in the battery compartment of the mouse to select the same channel as the one selected in step 2 and 5. (Open the battery cover to find the switch channel setting)

**Remarks:**

1. The keyboard uses 2pcs standard UM-3 (AA) 1.5V batteries, and the mouse uses 2pcs (AAA) batteries.
2. Battery life for the keyboard is approximately 3-4 months and for the mouse is approximately 2 months, depending on the intensity of usage.
3. The optical mouse is designed to save power after 10 minutes of inactivity. It goes into a sleep mode. Simply move the mouse to wake it up.
4. Make sure the receiver is placed in a location relatively free of strong electromagnetic or transmission sources in order to ensure optimal reception of the keyboard and mouse signal.





## ID Setting

This keyboard kits contains 2 channels and each channel contains 256 sets ID. This extra ID-recognition function helps to protect against interference from other RF keyboards in the same environment. After completing the hardware installation you must set the ID's of the receiver, mouse and keyboard.

**Step 1:** Press the ID button on the top of the receiver once.

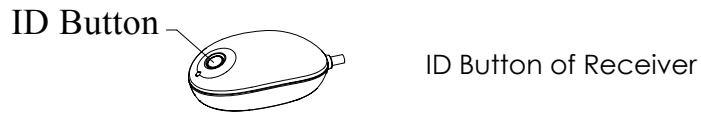

**Step 2:** Press the ID button on the bottom of the mouse and hold it until the receiver light goes to a solid yellow.

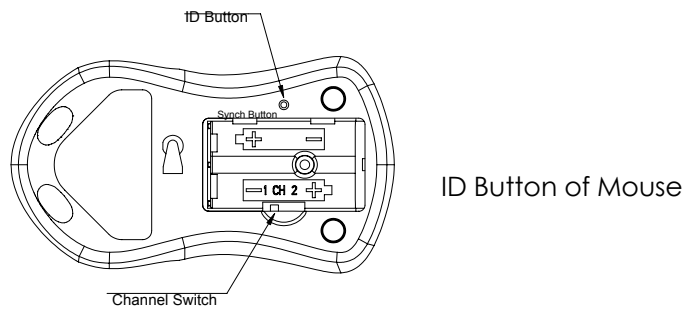

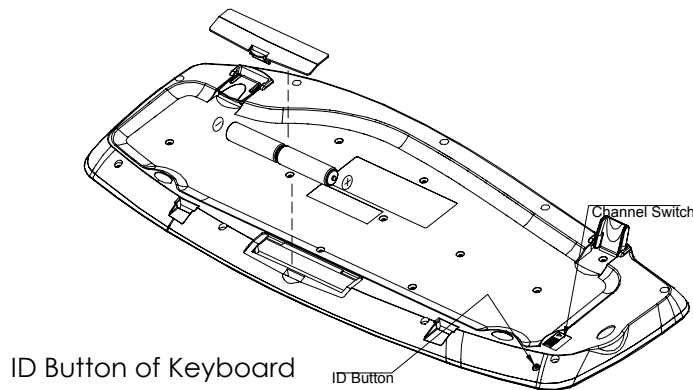

**Step 3:** Press the ID button on the bottom of the keyboard and hold it until the receiver light goes to a solid yellow.





**Remarks:**

1. You must follow the procedure above to set the ID of receiver, mouse and keyboard. Once the receiver ID button is pressed you have 35 seconds to complete the entire process, or you will need to begin again.
2. Once the keyboard and mouse USB connectors are plugged in the yellow receiver light will flash. Once the ID is set, it will remain steadily lit.
3. When changing the batteries of keyboard there is no need to reset all the ID's. Simply reset one of them.
4. When keyboard batteries are low, a battery low icon  will show on the right-bottom corner of the Windows taskbar.
5. When mouse batteries are low, a battery low icon  will show on the right-bottom corner of the Windows taskbar.

**Detachable Palmrest**

At your discretion, you may choose to connect the palmrest with the keyboard.

To connect the palmrest with the keyboard follow figure 1 & figure 2.

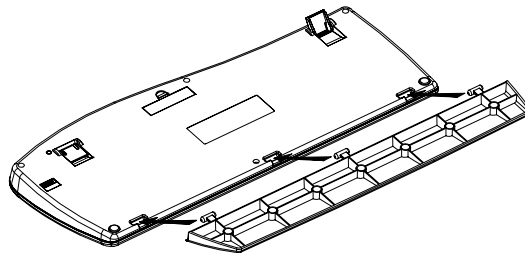

Figure

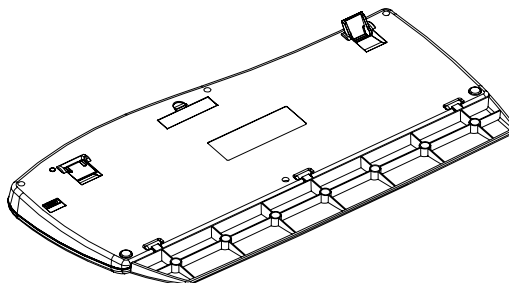

Figure  
2





## 4 Software Installation

After completing the hardware installation and turning the PC power on you will have immediate access to the alpha-numeric keys of the keyboard. In order to utilize the specialty keys you must first install the keyboard driver using the CD included in the box.

### **To install the keyboard driver:**

Step 1: Remove any existing keyboard software from the computer.

Step 2: Insert the driver CD in your computers CD-ROM drive, the software will auto run. If the software installation does not begin, select the CD-ROM drive on your computer and run "SetupKey.exe".

Step 3: Follow the on screen instructions to finish the installation procedure. The driver by default will be installed at C:\Program Files\KMaestro.

### **To install the Mouse driver:**

In order to take advantage of the special shortcut button functionality of the mouse you will have to install the mouse driver which is located on the driver CD included in the box.

Step 1: Make sure the driver CD is in your computers CD-ROM drive.

Step 2: Run the "Setup.exe" in the mouse-driver directory of the driver CD.

Step 3: Follow the onscreen instructions to finish the installation procedure.





## 5 Uninstallation

Please note that you have to uninstall the driver first if you want to reinstall the driver.

### To uninstall the keyboard driver:

- Step 1: Right-click the driver icon  and select "Exit" command to exit the driver program.
- Step 2: Click "Start" menu (on the left-bottom taskbar).
- Step 3: Move cursor to "Programs" in "Start" menu.
- Step 4: Move cursor again to "KeyMaestro".
- Step 5: Select "Uninstallation".
- Step 6: Click on the "Remove Program" icon.
- Step 7: Click "Yes" to confirm you want to uninstall.

### To uninstall the Mouse driver:

- Step 1: Click "Start" menu (on the left-bottom taskbar).
- Step 2: Move the cursor to "Programs" in Start menu.
- Step 3: Move the cursor again to "MMaestro".
- Step 4: Select "Uninstall KeyMaestro Mouse Driver".
- Step 5: Click Yes to confirm you want to uninstall.

If the keyboard is not working properly, see "[Troubleshooting](#)" for tips on how to solve your problem.





## 6 Smart Office Keyboard Driver

### 6.1 To Pop Up “KeyMaestro” Dialogue Box

Use left-click of the mouse on the Smart Office Keyboard Driver icon  on the taskbar, a “KeyMaestro” dialogue box will pop up with the following functions.

#### 6.1.1 Select a HotKey

This function contains the default function of a key. You can click on the "Display Label" box to re-define the key functions. Please refer to the “[Configure Button](#)” dialogue below.

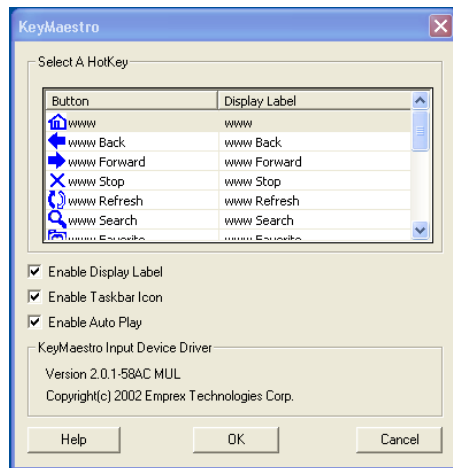

#### 6.1.2 Enable Display Label

This command is to show or hide the OSD (On Screen Display). When the OSD is enabled, each time you press any one of the multimedia buttons, its function name (button label) will show on the right-bottom corner on the screen. The default of this function is enabled.

#### 6.1.3 Enable Taskbar Icon

This command is to show or hide the taskbar driver icon. When the function is enabled, you can see a driver icon , its function name (button label) will show on the right-bottom corner of the screen. If you want to reload it again, you can select Start => Program => Configure to launch it. The default of this function is enabled.

#### 6.1.4 Enable Auto Play

This command is to show or hide the auto play function. When the function is enabled, the Microsoft media play will show on the screen after you press the “Play” key of the multimedia keys. For Winamp user, you can use the multimedia keys to control the Winamp function after you call out the Winamp and disable the





Auto play function. The default of this function is enabled.







## 6.2 To Pop Up “Configure Button” Dialogue Box

### 6.2.1 Label

In the Label box, type the name of application that the button will launch, or any name that will help you remember the function of the button. This label will appear on screen each time you press the button.

### 6.2.2 Functions

You can see a list of pre-defined functions and set one of it for the button.

### 6.2.3 Launch Application or Website

Type in the path to an often used application or click the Browse button to select any file on your computer. If you want to attach a web page to the button, just simply type in the website address in the dialogue box.

### 6.2.4 Combination Key

In many Windows application, there are many hot keys to execute some often used commands. Some of the hot keys are combined with two keys pressed simultaneously, and some are three. It is not easy to press and to remember those hot keys. Now you can define those complicated hot keys you always forgot. Any kind of combination is available. For example, [Alt] + [F4] = close window, [Ctrl] + [A] = select all.

### 6.2.5 String

You may define the button as a string of texts which needs to be input often. The maximum characters are 500. Taking good advantages of this function can save much your text input time and makes your works more efficient.

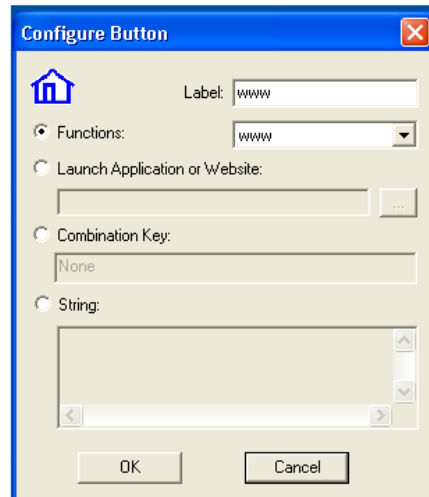

If the keyboard is not working properly, see [“Troubleshooting”](#) for tips on









how to solve your problem.











## 7 Using the Keyboard





### 7.1 Office Application Keys Block

	Word	Open Microsoft Word.
	Excel	Open Microsoft Excel.
	PowerPoint	Open Microsoft PowerPoint.
	Calendar	Open "Calendar" function of Microsoft Outlook.

### 7.2 Internet Keys Block

	Back	Return to the last page you viewed.
	Forward	View the next page you viewed before.
	Stop	If a page you are trying to view is taking too long to open, click this button to stop.
	Refresh	Refresh the current Web page in order to make sure you have the latest Web page.
	WWW	Open the default Internet browser.
	Search	Open the Internet search menu.
	My Favorite	Open the Internet "My Favorite" folder.
	E-mail	Open the default program you use for mail.

### 7.3 Application Keys Block

	My Computer	Open "My Computer".
	Calculator	Start Microsoft calculator.
	Log Off	Open the log off windows dialog box.
	Sleep	Place the computer in Sleep Mode.
	Power	Turn the computer off.









**Note:** If “Log Off” key function cannot work properly, see [“Troubleshooting”](#) for more information.





#### 7.4 Multimedia Keys Block

	Mute	Mute the sound.
	Volume up	Adjust the volume up.
	Volume down	Adjust the volume down.
	Stop	Stop the playing.
	Previous	Skip backward to the previous file/track when pressing once.
	Next	Skip forward to the next file/track when pressing once.
	Play/Pause	When the CD or Video is playing, press this button to pause it, and press the button again to resume it from the current position.

#### 7.5 Enhanced Function Keys Block

Enhanced function keys block consists of 12 keys and functions in two ways:

1. As a part of the main keyboard: F1~F12.
2. As 12 embedded office keys and functions.

Enhanced Function Keys are as follows:

- ◆ 12 keys for other languages.

 Office Wizard	A toggle key for Enhanced office keys. When Office Wizard LED is on, the enhanced Office function keys are activated.
F1: Help	Open the Help file for the activate window.
F2: New	Create a new, blank file in program.



F3: Open	Open or finds a file in program.
F4: Save	save the active file with current file name, location and file format.
F5: Replace	Search for and replaces the specified text and formatting.
F6: Spell	Start the spelling check program in the active document.
F7: Undo	Reverse the last command or deletes the last entry you typed or action.
F8: Redo	Reverse the action of the Undo command.
F9: Reply	Reply to the e-mail in Microsoft Outlook or Outlook Express.
F10: Reply All	Replies the e-mail to all in Microsoft Outlook or Outlook Express.
F11: Forward	Forwards the e-mail in Microsoft Outlook or Outlook Express.
F12: Send	Sends out the e-mail in Microsoft Outlook or Outlook Express.
Prt scr/Sys: Print	prints the file in the active window.
Num Lock: €	Euro sign. Make sure the LED of both "Office Wizard" and "num lock" are on. The Euro sign only works when both of the Office Wizard and Num Lock are activated.

**Note:** In Spanish Windows, F2 function is designed for "Bold".

**Note:** Microsoft Windows operating system and applications must support different languages for different countries; it limits the



functions of embedded office keys. So, some enhanced functions are only for target language usage. The descriptions of the enhanced office keys' functions are for reference and may not reflect your keyboard exactly.





## **7.6 Clipboard Keys Block**











Scroll Wheel	<ol style="list-style-type: none"><li>1. Works as a mouse with scrolling functions in 2 directions - up and down. You can use the up and down functions of the Scroll Wheel to scroll the document horizontally.</li><li>2. Works as a mouse button. When you push on the scroll wheel, a series functions dialogue will pop-up as below. Their functions are divided into 3 parts.<ul style="list-style-type: none"><li>◆ Works as "<a href="#">Internet keys</a>" or "<a href="#">Multimedia keys</a>". You can customize the push button as one of these functions.</li><li>◆ Works as Scroll Up/Down, Volume Up/Down, WWW Back/Forward or Previous/Next Track. If you customize the push button as one of these functions, you only have to use the wheel to control these functions.</li><li>◆ Works as "<a href="#">Configure</a>" function. Please refer to the description of the "<a href="#">Smart Office Keyboard Driver</a>" for more information.</li></ul></li></ol> 
--------------	--





		Cut	Remove the selection from the active document.
		Copy	Copy the selection to the Clipboard.
		Paste	Paste the previously cut or copied items from the Clipboard.
		Mark	Press on the mark key once and use the up, down, right and left direction keys to select items. Press the mark key again or any other keys except the up, down, right, left, home, end, page up or page down key, the mark function can be released.
	APP.	Application Switch	Switches the focus to the previous opened windows when you press the key and chooses the right one as the active window. The function is the same as "Alt+Tab".
	Close	Close	Closes the active Windows Application.



## 8 Using the Mouse

### 8.1 Using the Mouse Driver

After installing the mouse driver as described in Chapter 4 you will be able to start up the Mouse Control Panel by left double-clicking on the KeyMaestro Mouse icon  in the Windows task bar. This should appear after restarting your machine. You can also invoke the Mouse Control Panel by choosing Start→Programs→MMAestro→KeyMaestro Mouse Driver.

The Mouse Control Panel (KeyMaestro Mouse Properties) window consist of the following folders:

- ◆ Magic folder:  
allows you to change the browsing speed and the direction of the browsing button.
- ◆ Pointers folder:  
allows you to choose your favorite pointer shape.
- ◆ Cursor folder:  
select the special cursor functions such as trails for your cursor or loop function.
- ◆ Action folder:  
re-define the mouse keys function and speed.
- ◆ Settings folder:  
re-assign mouse button shortcuts and/or toggle Office 97 mouse mode on/off.
- ◆ About folder:  
shows the current driver version information.

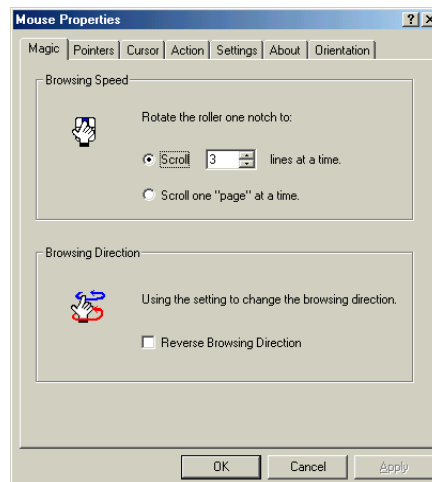



- ◆ Orientation folder:  
allows you to setup the angle of the mouse when moving upwards.











## 8.2 The Definition of Mouse Extra Function:

Function	Definition
Quick Jump	Let you to open 8 special functions quickly. For the detailed, please refer to the " <a href="#">Quick Jump Function Introduction</a> " in next section.
Double Click	Replace the "double click" movement to activate an application or function, it can save the valuable mouse-clicks.
Window Zoom	To magnify or de-magnify the data view of a document in an application that supports it. (this function is workable when the application you used is with the ctrl + wheel scrolling function, ie, Word, Excel, PowerPoint and FrontPage ...)
Switch AP	Switch quickly from one opened application to the other applications without extra cursor move. Press the "Switch AP" button you set and scroll the wheel button to switch the applications.
Auto Panning	Move the cursor and then the document will scroll slowly in the direction you just moved.
WWW Back	Return to the last page you viewed.
WWW Forward	View the next page you viewed before.

### 8.3 Quick Jump Function Introduction



Also, after installing the mouse driver and invoking the KeyMaestro mouse driver program you will have access to 9 special function icons by pressing the scroll wheel once. These 9 functions are:

	Mouse Control Panel	Activate the Mouse Control Panel Menu.
	Control Panel	Activate the "Control Panel" window.
	Horizontal Scroll Bar	Set the cursor to the horizontal scroll bar to scroll the document horizontally. (the function does not support Windows XP)
	Vertical Scroll Bar	Set the cursor to the vertical scroll bar to scroll the document vertically. (the function does not support Windows XP)
	Windows Explorer	Activate the 'Windows Explorer' window.
	Size Grip	Adjust the frame size of the windows you opened (the function does not support full screen. The function is also not performed when the frame of applications are not adjustable).
	Minimize All Windows	Allow you to minimize all the current opened applications immediately (this function is only performed when the applications are with the minimize function)
	Recall the Last Active Window	Recall the last active window.
	Exit	Exit the quick jump function panel.

Clicking once more on the scroll wheel will close these icons.

**Note:** For more detailed information please read the online help by right clicking on the KeyMaestro Mouse icon  in the Windows task bar



and select Help.





## 9 Troubleshooting

If you are experiencing problems with your keyboard, please check the following:

1. Keyboard & Mouse do not work properly

Please remember to set the ID when your keyboard kits do not work properly.

2. Mouse does not work accurately

Use the mouse only on a clean, flat, non-slippery surface in order to ensure smooth and accurate cursor action. If you use a mouse-pad, choose a light-colored one, not a dark one, to use less battery power.

3. The Smart Office Keyboard Software does not work properly

The hot key functions do not work after installing the Smart Office keyboard software, please make sure if there are any keyboard hot key drivers installed. Remove all keyboard hot key driver first and re-install Smart Office Keyboard Software to solve the problem.

4. Add/Remove Smart Office Keyboard Software or Re-install

After installing the Smart Office Keyboard software, the Smart Office Keyboard icon will display on the system tray. If you want to reinstall the software for some reasons, you must remove the Smart Office Keyboard driver from your operating system first. For more detailed information, please refer to [Uninstallation](#).

**Note: If you want to upgrade your Smart Office Keyboard software or it does not work properly, you can re-install it to solve this problem.**

5. Other software applications cannot be installed properly

If it is failed to install other software applications, you have to remove the Smart Office Keyboard driver from your system tray. After completing the new software installation, you have to re-install the Smart Office Keyboard Software again.

6. Multimedia Player cannot play VCD title or MPEG file

Make sure you have installed Windows Media Player version 7 or later properly. If not, please download the Windows Media Player version 7 or later from Microsoft Web site.







7. Word, Excel, PowerPoint, Calendar cannot do action, but the onscreen can show up

Please make sure you have installed the Office Applications completely. If Office Applications are not fully installed, those keys can only see the onscreen display and do not work.

8. Sleep key does not work properly

If you have problems using the sleep button, make sure that the power management in your PC has been enabled both in the BIOS and in Windows. For more information on your PC's BIOS settings, refer to your PC's manual. For more information on how to enable the power management features in Windows, refer to your Windows manual.

9. Some enhanced Office functions might lose

Microsoft Windows operating system and applications must support different language for different countries. It limits the functions of enhanced office keys. So, some enhanced functions are only for target language usage. The descriptions of the enhanced function keys are for reference and may not reflect your keyboard exactly.

10. The "Un-mark" function cannot be released

Press on the mark key once and use the up, down, right and left direction keys to select items. Press the mark key again or any other keys except the up, down, right, left, home, end, page up or page down key, the mark function can be released.

11. The functions of the enhanced Office function keys do not match the key's printed name or do not work

All enhanced office function keys follow the definitions of the standard Microsoft shortcut combination keys. They do not need any support from software driver. In few cases, when you press the target enhanced office keys, they do not work or have different result. This means the applications do not support the definitions of the standard Microsoft shortcut combination keys and the target functions, or the software applications conflict with the definitions.

We recommend you to contact with the software application dealer or download the new version application to upgrade your applications from Microsoft Web site. For example, use Office 2000 to





replace Office 97, or use IE 5.0 to replace IE 4.0.





## Technical Support

If the above instructions do not solve your problem, please contact Memorex technical support at [techsupport@memorex.com](mailto:techsupport@memorex.com), or visit us online at [www.memorex.com](http://www.memorex.com) for our Frequently Asked Questions (FAQ).

## Memorex Products One Year Limited Warranty.

Memorex Products, Inc. will replace this product free of charge if it is found to be defective in materials or workmanship during normal usage conditions for a period of one year from date of purchase (proof of purchase required). Other than product replacement (or refund if replacement is not possible), Memorex Products will not be responsible for any incidental or consequential damages arising from use of this product.

## Product Registration:

To register your product please visit us online at [www.memorex.com](http://www.memorex.com) or write to us with your name, address, phone number, model name, model number, date of purchase and place of purchase at: Memorex Products, Inc. 10100 Pioneer Blvd, Suite 110, Santa Fe Springs, CA 90670.





## FCC GUIDELINES

This equipment has been tested and found to comply with the limits for a Class B digital device, pursuant to Part 15 of the FCC Rules. These limits are designed to provide reasonable protection against harmful interference in a residential installation. This equipment generates, uses and can radiate radio frequency energy and, if not installed and used in accordance with the instructions may cause harmful interference to radio communications. However, there is no guarantee that interference will not occur in a particular installation. If this equipment does cause harmful interference to radio or television reception, which can be determined by turning the equipment off and on, the user is encouraged to try to correct the interference by one or more of the following measures:

- ◆ Reorient or relocate the receiving antenna
- ◆ Increase the separation between the equipment and receiver
- ◆ Connect the equipment into an outlet on a circuit different from that to which the receiver is connected.
- ◆ Consult the dealer or an experienced radio/TV technician for help.

The Class B digital apparatus meets all requirements of the Canadian Interference-Causing Equipment Regulation.

Cet appareil numérique de la class B respecte toutes les exigences du Règlement sur le matériel brouilleur du Canada.

### ***Caution:***

**Any changes or modifications not expressly approved by the party responsible for compliance could void the user's authority to operate this equipment. Shielded interface cable, if any, must be used in order to comply with emission limits.**