

**Exhibit L: User Manual - Part 1 of 2**

**FCC ID: HN2ABTM3-3**

# Important Radio Information!

## Contents

For Users in the United States and Canada .....	2
For 700C-802.11b Configuration.....	2
For ABTM3 (Bluetooth-Compatible Wireless Module by Socket Communications) Configuration .....	2
For MC45 (Wireless WAN, GSM/GPRS) Configuration .....	3
For SB555 (Wireless WAN, CDMA/1x) Configuration.....	3
For Users Outside of the United States and Canada .....	4
For 700C-802.11b Configuration.....	4
For ABTM3 (Bluetooth-Compatible Wireless Module by Socket Communications) Configuration .....	5
For MC45 (Wireless WAN, GSM/GPRS) Configuration .....	6
Pour les utilisateurs en dehors du Canada et des Etat-unis .....	7
Pour la configuration 700C-802.11b .....	7
Pour la configuration ABTM3 (Module sans fil compatible avec la norme Bluetooth de Socket Communications) .....	8
Pour la configuration MC45.....	8
Für Benutzer außerhalb von Kanada und den Vereinigten Staaten .....	9
700C-802.11b.....	9
ABTM3 (Bluetooth-kompatible Funkmodul von Socket Communications) .....	10
MC45 .....	10
Per gli utenti al di fuori del Canada o degli Stati Uniti .....	11
Per la configurazione di 700C-802.11b.....	11
Per la configurazione di ABTM3 (modulo wireless Bluetooth-compatibile della Socket Communications).....	11
Per la configurazione di MC45 .....	12
Para Usuarios Fuera de Canada o de los Estados Unidos .....	12
Para configuração do 700C-802.11b.....	12
Para configuração do ABTM3 (Módulo sem fio compatível com Bluetooth da Socket Communications) .....	13
Para configuração do MC45 .....	14
Para Usuários Fora do Canadá ou dos Estados Unidos .....	14
Para la configuración de 700C-802.11b.....	14
Para la configuración de ABTM3 (Módulo inalámbrico compatible con Bluetooth de Socket Communications) .....	15
Para la configuración de MC45.....	16

# For Users in the United States and Canada

Place this supplement in your manual.

## For 700C-802.11b Configuration

This device complies with Part 15 of the FCC Rules and with RSS-210 of Industry Canada. Operation is subject to the following two conditions: (1) This device may not cause harmful interference, and (2) This device must accept any interference received, including interference that can cause undesired operation.

### Federal Communications Commission Compliance

**FCC Digital Emissions Compliance:** This equipment has been tested and found to comply with the limits for a Class B digital device, pursuant to Part 15 of the FCC Rules. These limits are designed to provide reasonable protection against harmful interference in a residential installation. This equipment generates, uses, and can radiate radio frequency energy and, if not installed and used in accordance with the instructions, may cause harmful interference to radio communications. However, there is no guarantee that interference will not occur in a particular installation. If this equipment does cause harmful interference to radio or television reception, which can be determined by turning the equipment off and on, the user is encouraged to try to correct the interference by one or more of the following measures:

- Reorient or relocate the radio or television receiving antenna.
- Increase the separation between the computer equipment and receiver.
- Connect the equipment to an outlet on a circuit different from that to which the radio or television receiver is connected.
- Consult the dealer or an experienced radio television technician for help.



Warning

**Operation Warning: To comply with the FCC's RF exposure requirements and minimize health hazards:**

- **The user shall not touch the antenna of this device when the device is in use.**



Caution

**Changes or modifications not expressly approved by Intermec could void the user's authority to operate this equipment.**

### Industry Canada Compliance

This Class B digital apparatus meets all requirements of the Canadian Interference-Causing Equipment Regulations. This device requires a radio license unless it is used totally inside a building. (The user must obtain this license.)

Cet appareil numérique de la classe B respecte toutes les exigences du Règlement sur le matériel brouilleur du Canada. Cet appareil exige une licence radio à moins d'être entièrement installé dans un bâtiment. (L'utilisateur doit obtenir cette licence.)

### Agency Approvals

This device is UL Listed.

## For ABTM3 (Bluetooth-Compatible Wireless Module by Socket Communications) Configuration

This device complies with Part 15 of the FCC rules and with RSS-210 of Industry Canada.

Cet appareil est conforme à la Partie 15 des règlements du FCC et à la norme RSS-210 d'Industrie Canada.



Warning

**Operation Warning: To comply with the FCC's RF exposure requirements and minimize health hazards:**

- **The user shall not touch the antenna of this device when the device is in use.**



Caution

**Changes or modifications not expressly approved by Intermec could void the user's authority to operate this equipment.**

This device requires a radio license unless it is used totally inside a building. (The user must obtain this license.)

Cet appareil exige une licence radio à moins d'être entièrement installé dans un bâtiment. (L'utilisateur doit obtenir cette licence.)

### **Agency Approvals**

This device is UL Listed.

## **For MC45 (Wireless WAN, GSM/GPRS) Configuration**

This device complies with Part 24 of the FCC Rules and with RSS-133 of Industry Canada.

Cet appareil est conforme à la Partie 24 des règlements du FCC et à la norme RSS-133 d'Industrie Canada.



Warning

**Antennas must be supplied and installed as recommended by Intermec Technologies Corporation to ensure compliance to RF exposure requirements.**

**The user shall not touch the antenna of this device when the device is in use.**



Caution

**Agency Approvals: See user's guide instructions for handling, charging, and replacing batteries. Failure to follow those instructions can result in personal injury, fire, or battery explosion.**

## **For SB555 (Wireless WAN, CDMA/1x) Configuration**

This device complies with Parts 22 and 24 of the FCC Rules and with RSS-1383 of Industry Canada.

Cet appareil est conforme aux Parties 22 et 24 des règlements du FCC et à la norme RSS-1383 d'Industrie Canada.



Warning

**Antennas must be supplied and installed as recommended by Intermec Technologies Corporation to ensure compliance to RF exposure requirements.**



Caution

**Agency Approvals: See user's guide instructions for handling, charging, and replacing batteries. Failure to follow those instructions can result in personal injury, fire, or battery explosion.**

# For Users Outside of the United States and Canada

Place this supplement in your manual.

## For 700C-802.11b Configuration

The Intermec product you purchased transmits and receives data using a 2.4 GHz Direct Sequence Spread Spectrum system.

Programming and configuration information for the transceivers is also provided in the host device documentation. Please check the Intermec Web site for additional documentation at [www.intermec.com](http://www.intermec.com).

Hereby, Intermec Technologies Corporation declares that this Model 700C-802.11b is in compliance with the essential requirements and other relevant provisions of R&TTE Directive (1999/5/EC). This product has been assessed to the following standards:

- ETSI EN 300 328-2 v1.2.1 (2001-12)
- ETSI EN 301 489-17 v1.1.1 (2001-09)
- EN 60950:1992 (incl. Amdt. 1-4, 11)
- SP/DGPT/ATAS 23 (1995-02)

The original Declaration of Conformity is available on the Intermec Technologies Corporation Web site at [www.intermec.com](http://www.intermec.com).

This product transmits electromagnetic waves at 2.4 GHz frequency range. It has been tested and found compliant with U.S. (OET Guide 65) and Canadian (RSS 102) RF exposure regulations. There are no regulations covering this product type in the EU at this time.

The transmitter module's output power is 89 mW. The products using this module are intended for business and industrial environments. They should not be used in residential environments and by children.

**CE 0981** ⓘ This product is marked with this logo and uses radio frequency bands that are not harmonized throughout the European Community.

The following table indicates the areas of intended use of the equipment and any known restrictions.

Country of Intended Use	License Required		Restrictions	Details
	Yes	No		
Austria	X			
Belgium	X			
Denmark	X			
Finland	X			
France	X		X	Frequency operation restricted to 2446.5 MHz to 2483.5 MHz.
Germany	X			
Greece	X			
Ireland	X			
Italy	X			
Luxembourg	X			
The Netherlands	X			
Portugal	X			
Spain	X			
Sweden	X			
United Kingdom	X			

Country of Intended Use	License Required		Restrictions	Details
	Yes	No		
Other non-EU:				
Iceland	X			
Liechtenstein	X			
Norway	X			
Slovenia	X			
Switzerland	X			

### Additional EMI/RFI Compliance

This device meets the Class B limit requirements of CISPR 22.

## For ABTM3 (Bluetooth-Compatible Wireless Module by Socket Communications) Configuration

The Intermec product you purchased transmits and receives data using a 2.4 GHz Frequency Hopping Spread Spectrum system.

Programming and configuration information for the transceivers is also provided in the host device documentation. Please check the Intermec Web site for additional documentation at [www.intermec.com](http://www.intermec.com).

Hereby, Intermec Technologies Corporation declares that this Model 700C-ABTM3 is in compliance with the essential requirements and other relevant provisions of R&TTE Directive (1999/5/EC). This product has been assessed to the following standards:

- ETSI EN 300 328-2 v1.2.1 (2001-12)
- ETSI EN 301 489-17 v1.1.1 (2001-09)
- EN 60950:1992 (incl. Amdt. 1-4, 11)
- SP/DGPT/ATAS 23 (1995-02)

The original Declaration of Conformity is available on the Intermec Technologies Corporation Web site at [www.intermec.com](http://www.intermec.com).

This product transmits electromagnetic waves at 2.4 GHz frequency range. It has been tested and found compliant with U.S. (OET Guide 65) and Canadian (RSS 102) RF exposure regulations. There are no regulations covering this product type in the EU at this time.

The transmitter module's output power is 1 mW. The products using this module are intended for business and industrial environments. They should not be used in residential environments and by children.



This product is marked with this logo and uses radio frequency bands that are not harmonized throughout the European Community.

The following table indicates the areas of intended use of the equipment and any known restrictions.

Country of Intended Use	License Required		Restrictions	Details
	Yes	No		
Austria	X			
Belgium	X			
Denmark	X			
Finland	X			
France	X		X	Frequency operation restricted to 2446.5 MHz to 2483.5 MHz.
Germany	X			
Greece	X			
Ireland	X			
Italy	X			
Luxembourg	X			
The Netherlands	X			
Portugal	X			
Spain	X			
Sweden	X			
United Kingdom	X			
Other non-EU:				
Iceland	X			
Liechtenstein	X			
Norway	X			
Slovenia	X			
Switzerland	X			

### Additional EMI/RFI Compliance

This device meets the Class B limit requirements of CISPR 22.

### For MC45 (Wireless WAN, GSM/GPRS) Configuration

The Intermec product you purchased transmits and receives data using a 900/1800/1900 MHz GSM/GPRS radio module.

Programming and configuration information for the transceivers is also provided in the host device documentation. Please check the Intermec Web site for additional documentation at [www.intermec.com](http://www.intermec.com).

Hereby, Intermec Technologies Corporation declares that this Model 700C-MC45 is in compliance with the essential requirements and other relevant provisions of R&TTE Directive (1999/5/EC). This product has been assessed to the following standards:

- ETSI TS 51.010
- ETSI EN 301 489-7 v1.1.1 (2001-09)
- EN 60950:1992 (incl. Amdt. 1-4, 11)

The original Declaration of Conformity is available on the Intermec Technologies Corporation Web site at [www.intermec.com](http://www.intermec.com).

This product transmits electromagnetic waves at 900/1800/1900 MHz. It has been tested and found compliant with U.S. (OET Guide 65), Canadian (RSS 102), European (EN 50360/EN 50361), and Australian/New Zealand (AS/NZA 2772.1) RF exposure regulations.

The transmitter module's output power is 0.933 mW. The products using this module are intended for business and industrial environments. They should not be used in residential environments and by children.

**CE 0168** This product is marked with this logo.

#### **Additional EMI/RFI Compliance**

This device meets the Class B limit requirements of CISPR 22.

## **Pour les utilisateurs en dehors du Canada et des Etat-unis**

Veillez placer ce supplément dans votre manuel.

### **Pour la configuration 700C-802.11b**

Le produit Intermec que vous avez acheté peut transmettre et recevoir des données à l'aide d'un système d'étalement du spectre en séquence directe de 2,4 GHz.

Les informations de programmation et de configuration pour les émetteurs-récepteurs sont également fournies dans la documentation de l'appareil hôte. Pour obtenir toute documentation supplémentaire, veuillez consulter le site Web d'Intermec, à l'adresse [www.intermec.com](http://www.intermec.com).

Par la présente, Intermec Technologies Corporation déclare que ce modèle 700C-802.11b est conforme aux exigences de base et autres exigences pertinentes de la Directive R&TTE (1999/5/EC). Ce produit a été évalué par rapport aux normes suivantes :

- ETSI EN 300 328-2 v1.2.1 (2001-12)
- ETSI EN 301 489-17 v1.1.1 (2001-09)
- EN 60950:1992 (comprenant l'amendement 1-4, 11)
- SP/DGPT/ATAS 23 (1995-02)

La Déclaration de conformité originale est disponible sur le site Web d'Intermec Technologies Corporation, à l'adresse [www.intermec.com](http://www.intermec.com).

Ce produit émet des ondes électromagnétiques à une plage de fréquences de 2,4 GHz. Il a été évalué et reconnu conforme aux règlements concernant l'exposition à la radiofréquence des États-Unis (OET Guide 65) et du Canada (RSS 102). Il n'y a actuellement aucun règlement couvrant ce type de produit pour l'Union européenne.

La puissance de sortie du module émetteur-récepteur est de 89 mW. Les produits utilisant ce module sont destinés à des environnements commerciaux et industriels. Ils ne doivent pas être utilisés dans des environnements résidentiels et par des enfants.

**CE 0981** ⓘ Ce produit est marqué de ce logo et il utilise des bandes de fréquence radio qui ne sont pas harmonisées sur le territoire de la Communauté européenne.

Le tableau suivant répertorie les zones d'utilisation prévues pour l'équipement et les restrictions connues.

Pays d'utilisation prévu	Licence requise		Restrictions	Détails
	Oui	Non		
Belgique	X			
France	X		X	La fréquence d'opération est limitée à une valeur variant entre 2 446,5 MHz et 2 483,5 MHz.

#### **Conformité additionnelle à la norme EMI/RFI**

Cet appareil respecte les limites imposées pour la Classe B par le CISPR 22.



## Pour la configuration ABTM3 (Module sans fil compatible avec la norme Bluetooth de Socket Communications)

Le produit Intermec que vous avez acheté peut transmettre et recevoir des données à l'aide d'un système d'étalement du spectre en bond de fréquence de 2,4 GHz.

Les informations de programmation et de configuration pour les émetteurs-récepteurs sont également fournies dans la documentation de l'appareil hôte. Pour obtenir toute documentation supplémentaire, veuillez consulter le site Web d'Intermec, à l'adresse [www.intermec.com](http://www.intermec.com).

Par la présente, Intermec Technologies Corporation déclare que ce modèle 700C-ABTM3 est conforme aux exigences de base et autres exigences pertinentes de la Directive R&TTE (1999/5/EC). Ce produit a été évalué par rapport aux normes suivantes :

- ETSI EN 300 328-2 v1.2.1 (2001-12)
- ETSI EN 301 489-17 v1.1.1 (2001-09)
- EN 60950:1992 (comprenant l'amendement 1-4, 11)
- SP/DGPT/ATAS 23 (1995-02)

La Déclaration de conformité originale est disponible sur le site Web d'Intermec Technologies Corporation, à l'adresse [www.intermec.com](http://www.intermec.com).

Ce produit émet des ondes électromagnétiques à une plage de fréquences de 2,4 GHz. Il a été évalué et reconnu conforme aux règlements concernant l'exposition à la radiofréquence des États-Unis (OET Guide 65) et du Canada (RSS 102). Il n'y a actuellement aucun règlement couvrant ce type de produit pour l'Union européenne.

La puissance de sortie du module émetteur-récepteur est de 1 mW. Les produits utilisant ce module sont destinés à des environnements commerciaux et industriels. Ils ne doivent pas être utilisés dans des environnements résidentiels et par des enfants.



Ce produit est marqué de ce logo et il utilise des bandes de fréquence radio qui ne sont pas harmonisées sur le territoire de la Communauté européenne.

Le tableau suivant répertorie les zones d'utilisation prévues pour l'équipement et les restrictions connues.

Pays d'utilisation prévu	Licence requise		Restrictions	Détails
	Oui	Non		
Belgique	X			
France	X		X	La fréquence d'opération est limitée à une valeur variant entre 2 446,5 MHz et 2 483,5 MHz.

### Conformité additionnelle à la norme EMI/RFI

Cet appareil respecte les limites imposées pour la Classe B par le CISPR 22.

## Pour la configuration MC45

Le produit Intermec que vous avez acheté peut transmettre et recevoir des données à l'aide d'un module radio GSM/GPRS de 900/1800/1900 MHz.

Les informations de programmation et de configuration pour les émetteurs-récepteurs sont également fournies dans la documentation de l'appareil hôte. Pour obtenir toute documentation supplémentaire, veuillez consulter le site Web d'Intermec, à l'adresse [www.intermec.com](http://www.intermec.com).

Par la présente, Intermec Technologies Corporation déclare que ce modèle 700C-MC45 est conforme aux exigences de base et autres exigences pertinentes de la Directive R&TTE (1999/5/EC). Ce produit a été évalué par rapport aux normes suivantes :

- ETSI TS 51.010
- ETSI EN 301 489-7 v1.1.1 (2001-09)

- EN 60950:1992 (incl. Amdt. 1-4, 11)

La Déclaration de conformité originale est disponible sur le site Web d'Intermec Technologies Corporation, à l'adresse [www.intermec.com](http://www.intermec.com).

Ce produit émet des ondes électromagnétiques à une fréquence de 900/1800/1900 MHz. Il a été évalué et reconnu conforme aux règlements concernant l'exposition à la radiofréquence des États-Unis (OET Guide 65), du Canada (RSS 102), de l'Europe (EN 50360/EN 50361) ainsi que de l'Australie et de la Nouvelle-Zélande (AS/NZA 2772.1).

La puissance de sortie du module émetteur-récepteur est de 0.933 mW. Les produits utilisant ce module sont destinés à des environnements commerciaux et industriels. Ils ne doivent pas être utilisés dans des environnements résidentiels et par des enfants.

**CE 0168** Ce produit est marqué de ce logo.

#### **Conformité additionnelle à la norme EMI/RFI**

Cet appareil respecte les limites imposées pour la Classe B par le CISPR 22.

## **Für Benutzer außerhalb von Kanada und den Vereinigten Staaten**

Legen Sie diese Ergänzung in Ihr Handbuch.

### **700C-802.11b**

Das Intermec-Produkt, das Sie gekauft haben sendet und empfängt Daten mit Hilfe eines 2,4-GHz-Direktsequenz-Spreizspektrumsystems.

Dieses Produkt übermittelt elektromagnetische Wellen in einem Frequenzbereich von 2,4 GHz. Es wurde getestet und in Übereinstimmung mit U.S. (OET Anleitung 65) und kanadischen (RSS 102) RF-Bestrahlungsvorschriften befunden. Zur Zeit gibt es in der EU keine Richtlinien, die diesen Produkttyp abdecken.

In der Dokumentation des Hostgerätes finden Sie außerdem Informationen zum Programmieren und Konfigurieren der Sende-Empfangs-Geräte. Weitere Hinweise erhalten Sie auf der Intermec-Website unter [www.intermec.com](http://www.intermec.com).

Hiermit erklärt Intermec Technologies Corporation, dass das Modell 700C-802.11b mit den wesentlichen Anforderungen und anderen sachdienlichen Vorschriften der R&TTE-Richtlinie (1999/5/EC) übereinstimmt. Dieses Produkt wurde gemäß der folgenden Normen bewertet:

- ETSI EN 300 328-2 v1.2.1 (2001-12)
- ETSI EN 301 489-17 v1.1.1 (2001-09)
- EN 60950:1992 (einschl. Amdt. 1-4, 11)
- SP/DGPT/ATAS 23 (1995-02)

Die Originalkonformitätserklärung steht auf der Website der Intermec Technologies Corporation unter [www.intermec.com](http://www.intermec.com) zur Verfügung.

Die Ausgangsleistung des Sende-Empfangs-Moduls beträgt 89 mW. Die Produkte, die dieses Modul verwenden, sind für geschäftliche und industrielle Umgebungen gedacht. Sie sollten nicht in Wohngebieten und in der Nähe von Kindern verwendet werden.

**CE 0981** Das Produkt ist mit diesem Markenzeichen versehen und verwendet Radiofrequenzbreiten, die in der Europäischen Gemeinschaft nicht überall aufeinander abgestimmt sind.

#### **Zusätzliche Elektromagnetische Störung-Übereinstimmung**

Dieses Gerät entspricht den Grenzbestimmungen der Klasse B von CISPR 22.

## ABTM3 (Bluetooth-kompatibles Funkmodul von Socket Communications)

Das Intermec-Produkt, das Sie gekauft haben sendet und empfängt Daten mit Hilfe eines 2,4-GHz-Frequenzspringend-Spreizspektrumsystems.

Dieses Produkt übermittelt elektromagnetische Wellen in einem Frequenzbereich von 2,4 GHz. Es wurde getestet und in Übereinstimmung mit U.S. (OET Anleitung 65) und kanadischen (RSS 102) RF-Bestrahlungsvorschriften befunden. Zur Zeit gibt es in der EU keine Richtlinien, die diesen Produkttyp abdecken.

In der Dokumentation des Hostgerätes finden Sie außerdem Informationen zum Programmieren und Konfigurieren der Sende-Empfangs-Geräte. Weitere Hinweise erhalten Sie auf der Intermec-Website unter [www.intermec.com](http://www.intermec.com).

Hiermit erklärt Intermec Technologies Corporation, dass das Modell 700C- ABTM3 mit den wesentlichen Anforderungen und anderen sachdienlichen Vorschriften der R&TTE-Richtlinie (1999/5/EC) übereinstimmt. Dieses Produkt wurde gemäß der folgenden Normen bewertet:

- ETSI EN 300 328-2 v1.2.1 (2001-12)
- ETSI EN 301 489-17 v1.1.1 (2001-09)
- EN 60950:1992 (einschl. Amdt. 1-4, 11)
- SP/DGPT/ATAS 23 (1995-02)

Die Originalkonformitätserklärung steht auf der Website der Intermec Technologies Corporation unter [www.intermec.com](http://www.intermec.com) zur Verfügung.

Die Ausgangsleistung des Sende-Empfangs-Moduls beträgt 1 mW. Die Produkte, die dieses Modul verwenden, sind für geschäftliche und industrielle Umgebungen gedacht. Sie sollten nicht in Wohngebenden und in der Nähe von Kindern verwendet werden.

**CE 0168** ⓘ Das Produkt ist mit diesem Markenzeichen versehen und verwendet Radiofrequenzbreiten, die in der Europäischen Gemeinschaft nicht überall aufeinander abgestimmt sind.

### Zusätzliche Elektromagnetische Störung-Übereinstimmung

Dieses Gerät entspricht den Grenzbestimmungen der Klasse B von CISPR 22.

## MC45

Das Intermec-Produkt, das Sie gekauft haben, sendet und empfängt Daten mit Hilfe eines 900/1800/1900 MHz GSM/GPRS-Funkmoduls.

In der Dokumentation des Hostgerätes finden Sie außerdem Informationen zum Programmieren und Konfigurieren der Sende-Empfangs-Geräte. Weitere Hinweise erhalten Sie auf der Intermec-Website unter [www.intermec.com](http://www.intermec.com).

Hiermit erklärt Intermec Technologies Corporation, dass das Modell 700C-MC45 mit den wesentlichen Anforderungen und anderen sachdienlichen Vorschriften der R&TTE-Richtlinie (1999/5/EC) übereinstimmt. Dieses Produkt wurde gemäß der folgenden Normen bewertet:

- ETSI TS 51.010
- ETSI EN 301 489-7 v1.1.1 (2001-09)
- EN 60950:1992 (incl. Amdt. 1-4, 11)

Die Originalkonformitätserklärung steht auf der Website der Intermec Technologies Corporation unter [www.intermec.com](http://www.intermec.com) zur Verfügung.

Dieses Produkt übermittelt elektromagnetische Wellen in Frequenzbereichen von 900/1800/1900 MHz. Es wurde getestet und in Übereinstimmung mit U.S. (OET Anleitung 65), kanadischen (RSS 102), europäischen (EN 50360/EN 50361) und australischen/neuseeländischen (AS/NZA 2772.1) RF-Strahlungsvorschriften befunden.

Die Ausgangsleistung des Sende-Empfangs-Moduls beträgt 0.933 mW. Die Produkte, die dieses Modul verwenden, sind für geschäftliche und industrielle Umgebungen gedacht. Sie sollten nicht in Wohngebenden und in der Nähe von Kindern verwendet werden.

**CE 0168** Das Produkt ist mit diesem Markenzeichen versehen.

### **Zusätzliche Elektromagnetische Störung-Übereinstimmung**

Dieses Gerät entspricht den Grenzbestimmungen der Klasse B von CISPR 22.

## **Per gli utenti al di fuori del Canada o degli Stati Uniti**

Si prega di collocare questo supplemento nel manuale.

### **Per la configurazione di 700C-802.11b**

Il prodotto Intermec che avete acquistato trasmette e riceve i dati tramite un sistema a 2,4 GHz che utilizza la tecnologia DSSS (sequenza diretta, spettro esteso).

La documentazione del dispositivo host fornisce inoltre le informazioni sulla programmazione e la configurazione dei transceiver. Per altre informazioni, consultate il sito Web Intermec all'indirizzo [www.intermec.com](http://www.intermec.com).

Con la presente Intermec Technologies Corporation dichiara che questo Modello 700C-802.11b è conforme ai requisiti essenziali e alle altre clausole importanti della direttiva R&TTE (1999/5/EC). Questo prodotto è stato valutato in base ai seguenti standard:

- ETSI EN 300 328-2 v1.2.1 (2001-12)
- ETSI EN 301 489-17 v1.1.1 (2001-09)
- EN 60950:1992 (incluso Amdt. 1-4, 11)
- SP/DGPT/ATAS 23 (1995-02)

La dichiarazione di conformità originale è disponibile presso il sito Web di Intermec Technologies Corporation a [www.intermec.com](http://www.intermec.com).

Questo prodotto trasmette onde elettromagnetiche con una frequenza intorno ai 2,4 GHz. Dai collaudi ai quali è stato sottoposto è risultato conforme alle norme statunitensi (OET Guide 65) e a quelle canadesi (RSS 102) relative all'esposizione alle radiofrequenze. Attualmente non esistono norme relative a questo prodotto nell'Unione Europea.

La potenza di uscita del modulo trasmettente è di 89 mW. I prodotti che utilizzano questo modulo sono destinati ad ambienti industriali e commerciali e non debbono essere utilizzati in ambienti residenziali e dai bambini.

**CE 0981** ⓘ Questo prodotto reca questo marchio ed utilizza bande di radiofrequenza che non sono armonizzate nell'ambito della Comunità Europea.

### **Ulteriore conformità con EMI/RFI**

Questo dispositivo è conforme ai limiti stabiliti in CISPR 22 per la Classe B.

## **Per la configurazione di ABTM3 (modulo wireless Bluetooth-compatibile della Socket Communications)**

Il prodotto Intermec che avete acquistato trasmette e riceve i dati tramite un sistema a 2,4 GHz che utilizza la tecnologia FHSS (salto di frequenze, spettro esteso).

La documentazione del dispositivo host fornisce inoltre le informazioni sulla programmazione e la configurazione dei transceiver. Per altre informazioni, consultate il sito Web Intermec all'indirizzo [www.intermec.com](http://www.intermec.com).

Con la presente Intermec Technologies Corporation dichiara che questo Modello 700C- ABTM3 è conforme ai requisiti essenziali e alle altre clausole importanti della direttiva R&TTE (1999/5/EC). Questo prodotto è stato valutato in base ai seguenti standard:

- ETSI EN 300 328-2 v1.2.1 (2001-12)
- ETSI EN 301 489-17 v1.1.1 (2001-09)

- EN 60950:1992 (incluso Amdt. 1-4, 11)
- SP/DGPT/ATAS 23 (1995-02)

La dichiarazione di conformità originale è disponibile presso il sito Web di Intermec Technologies Corporation a [www.intermec.com](http://www.intermec.com).

Questo prodotto trasmette onde elettromagnetiche con una frequenza intorno ai 2,4 GHz. Dai collaudi ai quali è stato sottoposto è risultato conforme alle norme statunitensi (OET Guide 65) e a quelle canadesi (RSS 102) relative all'esposizione alle radiofrequenze. Attualmente non esistono norme relative a questo prodotto nell'Unione Europea.

La potenza di uscita del modulo trasmettente è di 1 mW. I prodotti che utilizzano questo modulo sono destinati ad ambienti industriali e commerciali e non debbono essere utilizzati in ambienti residenziali e dai bambini.

**CE 0168** ⓘ Questo prodotto reca questo marchio ed utilizza bande di radiofrequenza che non sono armonizzate nell'ambito della Comunità Europea.

#### **Ulteriore conformità con EMI/RFI**

Questo dispositivo è conforme ai limiti stabiliti in CISPR 22 per la Classe B.

## **Per la configurazione di MC45**

Il prodotto Intermec acquistato trasmette e riceve dati mediante un modulo radio GSM/GPRS a 900/1800/1900 MHz.

La documentazione del dispositivo host fornisce inoltre le informazioni sulla programmazione e la configurazione dei transceiver. Per altre informazioni, consultate il sito Web Intermec all'indirizzo [www.intermec.com](http://www.intermec.com).

Con la presente Intermec Technologies Corporation dichiara che questo Modello 700C-MC45 è conforme ai requisiti essenziali e alle altre clausole importanti della direttiva R&TTE (1999/5/EC). Questo prodotto è stato valutato in base ai seguenti standard:

- ETSI TS 51.010
- ETSI EN 301 489-7 v1.1.1 (2001-09)
- EN 60950:1992 (incl. Amdt. 1-4, 11)

La dichiarazione di conformità originale è disponibile presso il sito Web di Intermec Technologies Corporation a [www.intermec.com](http://www.intermec.com).

Questo prodotto trasmette onde elettromagnetiche a 900/1800/1900 MHz. Esso è stato collaudato ed è risultato conforme alle norme statunitensi (OET Guide 65), canadesi (RSS 102), europee (EN 50360/EN 50361) e australiane/nezelandesi (AS/NZA 2772.1) relative all'esposizione alle radiofrequenze.

La potenza di uscita del modulo trasmettente è di 0.933 mW. I prodotti che utilizzano questo modulo sono destinati ad ambienti industriali e commerciali e non debbono essere utilizzati in ambienti residenziali e dai bambini.

**CE 0168** ⓘ Questo prodotto reca questo marchio.

#### **Ulteriore conformità con EMI/RFI**

Questo dispositivo è conforme ai limiti stabiliti in CISPR 22 per la Classe B.

## **Para Usuarios Fuera de Canada o de los Estados Unidos**

Por favor, coloque este suplemento dentro de su manual.

## **Para configuração do 700C-802.11b**

Este producto de Intermec transmite y recibe datos por medio de un sistema de espectro ensanchado en secuencia directa de 2,4 GHz.

Para obtener información sobre la configuración y programación del transceptor, consulte la documentación provista con el dispositivo “host”. Para obtener documentación adicional, visite el sitio web de Intermec: [www.intermec.com](http://www.intermec.com).

Por la presente, Intermec Technologies Corporation declara que el Modelo 700C-802.11b cumple con los requisitos esenciales de acuerdo con la directiva (1999/5/EC) de R&TTE. Este producto ha sido evaluado de acuerdo con los siguientes estándares o normas:

- ETSI EN 300 328-2 v1.2.1 (2001-12)
- ETSI EN 301 489-17 v1.1.1 (2001-09)
- EN 60950:1992 (incl. Enmienda 1-4, 11)
- SP/DGPT/ATAS 23 (1995-02)

La Declaración de Conformidad original está disponible en el sitio web de Intermec Technologies Corporation: [www.intermec.com](http://www.intermec.com).

Este producto transmite ondas electromagnéticas de radio en la gama de frecuencias de 2,4 GHz. Ha sido probado y se ha determinado que cumple con las reglamentaciones de los EE.UU. (OET Guide 65) y del Canadá (RSS 102), referentes a la exposición de RF. En este momento, no existen reglamentaciones que abarquen este producto en la UE.

La potencia de salida del módulo transmisor es de 89 mW. Los productos que usan este módulo están destinados para uso en ambientes comerciales e industriales. No deben ser usados en ambientes residenciales o en la proximidad de niños.



Este producto está marcado con este logotipo y usa bandas de frecuencia de radio que no han sido armonizadas a lo largo de la Unión Europea.

#### **Conformidad adicional con EMI/RFI**

Este dispositivo cumple con los límites requeridos para la Clase B de CISPR 22.

## **Para configuração do ABTM3 (Módulo sem fio compatível com Bluetooth da Socket Communications)**

Este producto de Intermec transmite y recibe datos por medio de un sistema de espectro ensanchado en lupulización de frecuencia de 2,4 GHz.

Para obtener información sobre la configuración y programación del transceptor, consulte la documentación provista con el dispositivo “host”. Para obtener documentación adicional, visite el sitio web de Intermec: [www.intermec.com](http://www.intermec.com).

Por la presente, Intermec Technologies Corporation declara que el Modelo 700C- ABTM3 cumple con los requisitos esenciales de acuerdo con la directiva (1999/5/EC) de R&TTE. Este producto ha sido evaluado de acuerdo con los siguientes estándares o normas:

- ETSI EN 300 328-2 v1.2.1 (2001-12)
- ETSI EN 301 489-17 v1.1.1 (2001-09)
- EN 60950:1992 (incl. Enmienda 1-4, 11)
- SP/DGPT/ATAS 23 (1995-02)

La Declaración de Conformidad original está disponible en el sitio web de Intermec Technologies Corporation: [www.intermec.com](http://www.intermec.com).

Este producto transmite ondas electromagnéticas de radio en la gama de frecuencias de 2,4 GHz. Ha sido probado y se ha determinado que cumple con las reglamentaciones de los EE.UU. (OET Guide 65) y del Canadá (RSS 102), referentes a la exposición de RF. En este momento, no existen reglamentaciones que abarquen este producto en la UE.

La potencia de salida del módulo transmisor es de 1 mW. Los productos que usan este módulo están destinados para uso en ambientes comerciales e industriales. No deben ser usados en ambientes residenciales o en la proximidad de niños.



Este producto está marcado con este logotipo y usa bandas de frecuencia de radio que no han sido armonizadas a lo largo de la Unión Europea.

#### **Conformidad adicional con EMI/RFI**

Este dispositivo cumple con los límites requeridos para la Clase B de CISPR 22.

### **Para configuração do MC45**

O produto Intermec que você adquiriu transmite e recebe dados utilizando um módulo de rádio GSM/GPRS de 900/1800/1900 MHz .

Para obtener información sobre la configuración y programación del transceptor, consulte la documentación provista con el dispositivo "host". Para obtener documentación adicional, visite el sitio web de Intermec: [www.intermec.com](http://www.intermec.com).

Por la presente, Intermec Technologies Corporation declara que el Modelo 700C-MC45 cumple con los requisitos esenciales de acuerdo con la directiva (1999/5/EC) de R&TTE. Este producto ha sido evaluado de acuerdo con los siguientes estándares o normas:

- ETSI TS 51.010
- ETSI EN 301 489-7 v1.1.1 (2001-09)
- EN 60950:1992 (incl. Amdt. 1-4, 11)

La Declaración de Conformidad original está disponible en el sitio web de Intermec Technologies Corporation: [www.intermec.com](http://www.intermec.com).

Este produto transmite ondas eletromagnéticas a 900/1800/1900 MHz. Ele foi testado e mostrou-se compatível com as regulamentações sobre exposição a RF dos Estados Unidos (OET Guide 65), do Canadá (RSS 102), da Europa (EN 50360/EN 50361) e da Austrália/Nova Zelândia (AS/NZA 2772.1).

La potencia de salida del módulo transmisor es de 0.933 mW. Los productos que usan este módulo están destinados para uso en ambientes comerciales e industriales. No deben ser usados en ambientes residenciales o en la proximidad de niños.



Este producto está marcado con este logotipo.

#### **Conformidad adicional con EMI/RFI**

Este dispositivo cumple con los límites requeridos para la Clase B de CISPR 22.

### **Para Usuários Fora do Canadá ou dos Estados Unidos**

Coloque este suplemento no seu manual.

### **Para la configuración de 700C-802.11b**

O produto Intermec que você comprou transmite e recebe dados usando um sistema DSSS (Espectro de Difusão de Sequência Direta) de 2,4 GHz .

As informações sobre programação e configuração dos transceptores também são fornecidas na documentação do dispositivo hospedeiro. Consulte também o site da Intermec na web, no endereço [www.intermec.com](http://www.intermec.com), para documentação complementar.

Por este documento, a Intermec Technologies Corporation declara que o Modelo 700C-802.11b atende aos requisitos essenciais e outras condições relevantes da Diretiva R&TTE (1999/5/EC). Esse produto foi avaliado em relação aos seguintes padrões:

- ETSI EN 300 328-2 v1.2.1 (2001-12)
- ETSI EN 301 489-17 v1.1.1 (2001-09)

- EN 60950:1992 (incluída Amdt. 1-4, 11)
- SP/DGPT/ATAS 23 (1995-02)

A Declaração de Conformidade original está disponível no site da web da Intermec Technologies Corporation no endereço [www.intermec.com](http://www.intermec.com).

Este produto transmite ondas eletromagnéticas na faixa de frequência de 2,4 GHz. Ele foi testado e aprovado quanto à sua conformidade com os regulamentos de exposição à RF dos EUA (OET Guide 65) e do Canadá (RSS 102). Não existem regulamentos cobrindo esse tipo de produto atualmente na UE.

A potência de saída do módulo transmissor é de 89 mW. Os produtos que usam este módulo são destinados aos ambientes comerciais e industriais. Eles não devem ser utilizados em ambientes residenciais e por crianças.

**CE 0981** ⓘ Este produto é identificado por esta logomarca e utiliza bandas de frequência de rádio que não estão harmonizadas na Comunidade Européia.

#### **Conformidades EMI/RFI Adicionais**

Este produto atende aos requisitos de limite Classe B do CISPR22.

## **Para la configuración de ABTM3 (Módulo inalámbrico compatible con Bluetooth de Socket Communications)**

O produto Intermec que você comprou transmite e recebe dados usando um sistema FHSS (Espectro de Difusão de Sequência Hopping) de 2,4 GHz .

As informações sobre programação e configuração dos transceptores também são fornecidas na documentação do dispositivo hospedeiro. Consulte também o site da Intermec na web, no endereço [www.intermec.com](http://www.intermec.com), para documentação complementar.

Por este documento, a Intermec Technologies Corporation declara que o Modelo 700C- ABTM3 atende aos requisitos essenciais e outras condições relevantes da Diretiva R&TTE (1999/5/EC). Esse produto foi avaliado em relação aos seguintes padrões:

- ETSI EN 300 328-2 v1.2.1 (2001-12)
- ETSI EN 301 489-17 v1.1.1 (2001-09)
- EN 60950:1992 (incluída Amdt. 1-4, 11)
- SP/DGPT/ATAS 23 (1995-02)

A Declaração de Conformidade original está disponível no site da web da Intermec Technologies Corporation no endereço [www.intermec.com](http://www.intermec.com).

Este produto transmite ondas eletromagnéticas na faixa de frequência de 2,4 GHz. Ele foi testado e aprovado quanto à sua conformidade com os regulamentos de exposição à RF dos EUA (OET Guide 65) e do Canadá (RSS 102). Não existem regulamentos cobrindo esse tipo de produto atualmente na UE.

A potência de saída do módulo transmissor é de 1 mW. Os produtos que usam este módulo são destinados aos ambientes comerciais e industriais. Eles não devem ser utilizados em ambientes residenciais e por crianças.

**CE 0168** ⓘ Este produto é identificado por esta logomarca e utiliza bandas de frequência de rádio que não estão harmonizadas na Comunidade Européia.

#### **Conformidades EMI/RFI Adicionais**

Este produto atende aos requisitos de limite Classe B do CISPR22.



## Para la configuración de MC45

El producto de Intermec adquirido transmite y recibe datos utilizando un módulo de radio GSM/GPRS de 900/1800/1900 MHz.

As informações sobre programação e configuração dos transceptores também são fornecidas na documentação do dispositivo hospedeiro. Consulte também o site da Intermec na web, no endereço [www.intermec.com](http://www.intermec.com), para documentação complementar.

Por este documento, a Intermec Technologies Corporation declara que o Modelo 700C-MC45 atende aos requisitos essenciais e outras condições relevantes da Diretiva R&TTE (1999/5/EC). Esse produto foi avaliado em relação aos seguintes padrões:

- ETSI TS 51.010
- ETSI EN 301 489-7 v1.1.1 (2001-09)
- EN 60950:1992 (incl. Amdt. 1-4, 11)

A Declaração de Conformidade original está disponível no site da web da Intermec Technologies Corporation no endereço [www.intermec.com](http://www.intermec.com).

Este producto transmite ondas electromagnéticas en 900/1800/1900 MHz. Ha sido evaluado y cumple con las regulaciones de exposición a RF (radio frecuencias) de EE.UU. (OET Guide 65), Canadá (RSS 102), Comunidad Europea (EN 50360/EN 50361) y Australia-Nueva Zelanda (AS/NZA 2772.1).

A potência de saída do módulo transmissor é de 0.933 mW. Os produtos que usam este módulo são destinados aos ambientes comerciais e industriais. Eles não devem ser utilizados em ambientes residenciais e por crianças.

**CE 0168** Este produto é identificado por esta logomarca.

### Conformidades EMI/RFI Adicionais

Este produto atende aos requisitos de limite Classe B do CISPR22.

700 Series Color Mobile Computer Radio Manual Supplement



\*072719-002\*

**Intermec**

Technologies Corporation  
6001 36th Avenue West  
Everett, WA 98203  
U.S.A.

[www.intermec.com](http://www.intermec.com)

© 2002 Intermec Technologies Corp.  
All Rights Reserved

The Intermec logo is displayed in a bold, blue, sans-serif font. It is positioned to the left of a blue square icon that contains a white circular graphic with a stylized 'i' or 'e' shape. The logo and icon are set against a background of light blue, overlapping circular lines that resemble an orbital or network diagram.

**Intermec**



**User's Manual**



**700 Series Color  
Mobile Computer**



**Intermec**



User's Manual

**700 Series Color  
Mobile Computer**

• **NOTICE**

The information contained herein is proprietary and is provided solely for the purpose of allowing customers to operate and service Intermec manufactured equipment and is not to be released, reproduced, or used for any other purpose without written permission of Intermec.

Disclaimer of Warranties. The sample source code included in this document is presented for reference only. The code does not necessarily represent complete, tested programs. The code is provided "AS IS WITH ALL FAULTS." **ALL WARRANTIES ARE EXPRESSLY DISCLAIMED, INCLUDING THE IMPLIED WARRANTIES OF MERCHANTABILITY AND FITNESS FOR A PARTICULAR PURPOSE.**

We welcome your comments concerning this publication. Although every effort has been made to keep it free of errors, some may occur. When reporting a specific problem, please describe it briefly and include the book title and part number, as well as the paragraph or figure number and the page number.

Send your comments to:  
Intermec Technologies Corporation  
Publications Department  
550 Second Street SE  
Cedar Rapids, IA 52401

ANTARES, INTERMEC, NORAND, NOR\*WARE, PEN\*KEY, ROUTEPOWER, TRAKKER, and TRAKKER ANTARES are registered trademarks and ArciTech, ENTERPRISE WIRELESS LAN, i-gistics, INCA, Mobile Framework, MobileLAN, TE 2000, UAP, and UNIVERSAL ACCESS POINT are trademarks of Intermec Technologies Corporation.

© 2002 Intermec Technologies Corporation. All rights reserved.

## Acknowledgments

*ActiveSync*, *ActiveX*, *Microsoft*, *MS*, *MS-DOS*, *Outlook*, *Pocket Outlook*, *Pocket PC*, *Windows*, *Windows NT*, and the *Windows logo* are registered trademarks and *MSDN*, *SQL Server*, *Visual Basic*, *Visual C++*, and *Windows for Pen* are trademarks of Microsoft Corporation in the United States and/or other countries. Microsoft products are licensed to OEMs by Microsoft Licensing, Inc., a wholly owned subsidiary of Microsoft Corporation.

*Bluetooth* is a trademark of Bluetooth SIG, Inc., U.S.A.

*CDMA2000* is a trademark of the Telecommunications Industry Association (TIA).

*GSM* is a registered trademark of the GSM Association.

*Microclean II* is a registered trademark of Foresight International.

*MultiMediaCard* is a trademark of Infineon Technologies AG, Germany, and is licensed to MMCA (MultiMediaCard Association).

*SanDisk* is a trademark of SanDisk Corporation.

*Siemens* is a registered trademark of Siemens AG. Siemens product names are either trademarks or registered trademarks of Siemens or Siemens AG.

*Sprint* is a registered trademark of Sprint Communications Company L.P.

This product includes software developed by the OpenSSL Project for use in the OpenSSL Toolkit. (<http://www.openssl.org/>)

This product includes cryptographic software written by Eric Young ([ey@cryptsoft.com](mailto:ey@cryptsoft.com))

# Contents

Before You Begin .....	xv
Warranty Information .....	xv
Safety Summary .....	xv
Warnings, Cautions, and Notes .....	xvi
About This Manual .....	xvi
Format Conventions for Input From a Keyboard or Keypad .....	xvii
Related Publications .....	xviii
Global Services and Support .....	xviii
Web Support .....	xviii

## 1 Introduction

About the 700 Series Color Mobile Computer .....	2
Audio System .....	2
Speaker .....	2
Internal Microphone .....	2
External Headset Jack .....	2
Battery .....	2
Low Battery Shutdown .....	3
System Status Maintained .....	4
CAB Files Within 700C Software Tools CD .....	4
Modem Support .....	4
Network Support .....	4
Removeable Card Support .....	5
CompactFlash Cards .....	5
SecureDigital Cards .....	5
MultiMediaCards .....	5
Software Build Version .....	5
What's New .....	6

# 2 Pocket PC 2002

- Introduction . . . . . 8
- Premium versus Professional Editions . . . . . 8
- Where to Find Information . . . . . 10
- Basic Skills . . . . . 11
  - Buttons and Stylus . . . . . 11
  - Today Screen . . . . . 11
  - Programs . . . . . 13
  - Navigation Bar and Command Bar . . . . . 14
  - Pop-up Menus . . . . . 15
  - Notifications . . . . . 15
  - Enter Information on Your 700 Series Computer . . . . . 16
    - Typing With the Soft Keyboard . . . . . 17
    - Using Block Recognizer . . . . . 17
    - Using Letter Recognizer . . . . . 18
    - Using Transcriber . . . . . 18
    - Selecting Typed Text . . . . . 18
  - Writing on the Screen . . . . . 19
    - Selecting the Writing . . . . . 19
    - Converting Writing to Text . . . . . 20
  - Drawing on the Screen . . . . . 22
    - Creating a Drawing . . . . . 22
    - Selecting a Drawing . . . . . 22
  - Recording a Message . . . . . 23
    - Creating a Recording . . . . . 23
  - Using My Text . . . . . 24
  - Finding and Organizing Information . . . . . 25
  - Customizing Your 700 Series Computer . . . . . 26
    - Adjusting Settings . . . . . 26
    - Adding or Removing Programs . . . . . 26
- Microsoft ActiveSync . . . . . 29
- Microsoft Pocket Outlook . . . . . 31
  - Calendar: Scheduling Appointments and Meetings . . . . . 31
    - Creating an Appointment . . . . . 32
    - Using the Summary Screen . . . . . 33
    - Creating Meeting Requests . . . . . 33
    - Scheduling a Meeting . . . . . 33
  - Contacts: Tracking Friends and Colleagues . . . . . 34
    - Creating a Contact . . . . . 34
    - Finding a Contact . . . . . 35
    - Using the Summary Screen . . . . . 36
  - Tasks: Keeping a To Do List . . . . . 37
    - Creating a Task . . . . . 38
    - Using the Summary Screen . . . . . 39
  - Notes: Capturing Thoughts and Ideas . . . . . 40
    - Creating a Note . . . . . 41

Inbox: Sending and Receiving E-mail Messages .....	42
Synchronizing E-mail Messages .....	42
Connecting Directly to an E-mail Server .....	42
Using the Message List .....	43
Composing Messages .....	45
Managing E-mail Messages and Folders .....	46
Folder Behavior With a Direct Connection to an E-mail Server .....	46
Companion Programs .....	47
Pocket Word .....	47
Creating a Document .....	47
Typing Mode .....	49
Writing Mode .....	50
Drawing Mode .....	51
Recording Mode .....	51
Pocket Excel .....	52
Creating a Workbook .....	52
Tips for Working in Pocket Excel .....	53
MSN Messenger .....	53
Setting Up .....	54
Working with Contacts .....	54
Chatting with Contacts .....	55
Windows Media Player for Pocket PC .....	57
Microsoft Reader .....	58
Getting Books on Your 700 Series Computer .....	58
Using the Library .....	59
Reading a Book .....	60
Using Reader Features .....	61
Removing a Book .....	61
Pocket Internet Explorer .....	62
The Mobile Favorites Folder .....	62
Favorite Links .....	62
Mobile Favorites .....	62
Using AvantGo Channels .....	64
Using Pocket Internet Explorer .....	65
Viewing Mobile Favorites and Channels .....	66
Browsing the Internet .....	66
Getting Connected .....	67
Transferring Items Using Infrared .....	67
Sending Information .....	67
Receiving Information .....	67
Connecting to an Internet Service Provider .....	68
Creating a Modem Connection to an ISP .....	68
Creating an Ethernet Connection to an ISP .....	69
Connecting to Work .....	70
Creating a Modem Connection to Work .....	70
Creating an Ethernet Connection to Work .....	71
Ending a Connection .....	72
Connecting Directly to an E-mail Server .....	72
Setting Up an E-mail Service .....	73

## 3 Installing Applications

Packaging an Application .....	76
Installing Applications .....	76
Using Microsoft ActiveSync .....	77
Using the FTP Server .....	78
Using the Application Manager in Unit Manager .....	78
Using a Storage Card .....	78
Copying to a CompactFlash Card .....	78
Copying to a SecureDigital Storage Card .....	79
Updating the System Software .....	79
Application Migration .....	80
Cabinet File Installation .....	82

## 4 Network Support

CORE .....	84
Network Adapters .....	85
Ethernet Communications .....	86
802.11b Communications .....	87
Profiles .....	87
Import/Export .....	96
Scan List .....	97
Network Selection APIs .....	98
Function Summary .....	101
802.11b Radio CORE Module .....	107
WWAN Radio Options .....	110
GSM/GPRS .....	110
CDMA/1xRTT SB555 .....	110
WAN Radio CORE Module .....	111
AT Command Interface .....	115
Wireless Printing .....	120
Documentation .....	120
Bluealps CORE Module .....	120
AutoIP/DHCP .....	122
SNMP Configuration .....	123
The Focus was “Simple” .....	123
Using SNMP .....	123
Retrieval of Management Information .....	124
An Early Approach to Getting More than One Item at a Time .....	124
Conclusion .....	124
SNMP Configuration on the 700 Series Computer .....	125
Management Information Base .....	125
Object Identifiers .....	126
Configuring with SNMP .....	126



## 5 Printer Support

Printing ASCII .....	128
Directly to a Port .....	128
Directly to a Generic Serial Port .....	128
IrDA Printer Driver .....	128
NPCP Printer Driver .....	129
About NPCP .....	129
NPCP Driver Installation and Removal .....	129
Opening the NPCP Driver .....	130
Closing the NPCP Driver .....	130
Reading from the NPCP Driver .....	130
Writing to the NPCP Driver .....	130
NPCP Driver I/O Controls .....	131
NPCP Printer Communications .....	132
Sample Code .....	132
NPCP Error Codes .....	133
O'Neil Printer Driver .....	134
DTR Driver Installation and Removal .....	134
Opening the DTR Driver .....	135
Closing the DTR Driver .....	135
Writing to the DTR Driver .....	135
DTR Printer Communications .....	135

## 6 Scanner Support

Scanner Control and Data Transfer .....	138
Automatic Data Collection COM Interfaces .....	138
Multiple ADC COM Object Support .....	139
How to Create and Use the ADC COM Interfaces .....	140
Read-Ahead Bar Code Data Access .....	140
Grid Data Filtering .....	141
Filter Expression Values .....	142
Editing Expression Values .....	144
ADC Connection .....	145
2D Imager Overview .....	146
Data Collection Features .....	146
Image Acquisition Features .....	147
Create and Delete ADC COM Object Functions .....	149
ITCDeviceOpen .....	149
ITCDeviceClose .....	150

IADC Functions .....	151
IADC::CancelReadRequest .....	152
IADC::Initialize .....	153
IADC::QueryAttribute .....	154
IADC::QueryData .....	155
IADC::Read .....	156
IADC::SetAttribute .....	157
IBarcodeReaderControl Functions .....	159
IBarcodeReaderControl::CancelReadRequest .....	160
IBarcodeReaderControl::ControlLED .....	161
IBarcodeReaderControl::Initialize .....	162
IBarcodeReaderControl::IssueBeep .....	163
IBarcodeReaderControl::QueryAttribute .....	164
IBarcodeReaderControl::Read .....	165
IBarcodeReaderControl::SetAttribute .....	167
IBarcodeReaderControl::TriggerScanner .....	171
IS9CConfig Functions .....	172
IS9CConfig::GetCodabar .....	173
IS9CConfig::SetCodabar .....	174
Codabar Default Settings .....	175
Codabar Enumerations .....	175
IS9CConfig::GetCode39 .....	176
IS9CConfig::SetCode39 .....	177
Code 39 Default Settings .....	177
Code 39 Enumerations .....	178
IS9CConfig::GetCode93 .....	179
IS9CConfig::SetCode93 .....	179
Code 93 Default Settings .....	179
Code 93 Enumerations .....	180
IS9CConfig::GetCode128 .....	180
IS9CConfig::SetCode128 .....	181
Code 128/EAN 128 Default Settings .....	181
Code 128 Enumerations .....	182
IS9CConfig::GetI2of5 .....	183
IS9CConfig::SetI2of5 .....	184
Interleaved 2 of 5 Default Settings .....	184
Interleaved 2 of 5 Enumerations .....	185
IS9CConfig::GetMatrix2of5 .....	185
IS9CConfig::SetMatrix2of5 .....	186
Matrix 2 of 5 Default Settings .....	186
Matrix 2 of 5 Enumerations .....	186
IS9CConfig::GetMSI .....	187
IS9CConfig::SetMSI .....	187
MSI Default Settings .....	187
MSI Enumerations .....	188
IS9CConfig::GetPDF417 .....	188
IS9CConfig::SetPDF417 .....	189
PDF 417 Default Settings .....	190
PDF 417 Enumerations .....	190
IS9CConfig::GetPlessey .....	192
IS9CConfig::SetPlessey .....	192
Plessey Default Settings .....	193
Plessey Enumerations .....	193
IS9CConfig::GetStandard2of5 .....	194
IS9CConfig::SetStandard2of5 .....	195

Standard 2 of 5 Default Settings	196
Standard 2 of 5 Enumerations	196
IS9CConfig::GetTelepen	197
IS9CConfig::SetTelepen	197
Telepen Default Settings	197
Telepen Enumerations	198
IS9CConfig::GetUpcEan	198
IS9CConfig::SetUpcEan	200
UPC/EAN Default Settings	201
UPC/EAN Enumerations	201
IS9CConfig2 Functions	204
IS9CConfig2::GetCode11	205
IS9CConfig2::SetCode11	205
Code 11 Default Settings	206
Code 11 Enumerations	206
IS9CConfig2::GetCustomSymIds	207
IS9CConfig2::SetCustomSymIds	208
Custom Identifier Assignments	209
Custom Identifier Default Settings	210
Custom Identifier Example	210
IS9CConfig2::GetGlobalAmble	211
IS9CConfig2::SetGlobalAmble	212
Postamble and Preamble Defaults	212
IS9CConfig2::GetPDF417Ext	213
IS9CConfig2::SetPDF417Ext	213
PDF 417 Extended: Micro PDF 417 Default Settings	214
IS9CConfig2::GetSymIdXmit	214
IS9CConfig2::SetSymIdXmit	214
Symbology ID Transmission Option	215
IS9CConfig3 Functions	216
ISCP Commands	216
ISCP::GetConfig	217
ISCP::SetConfig	218
AIM Symbology ID Defaults	219
IImage Interface	221
IImage::ReadSigCapBuffer	221
IImage::ReadSigCapFile	224
IImage::ReadImage	225
IImage::CancelReadImage	226
IImage::Start	226
IImage::Stop	227
IImage::Open	227
IImage::Close	228
Data Collection Configuration	229

## Contents

Tethered Scanner .....	230
Enabling and Disabling .....	230
Changing Comm Settings .....	231
Tethered Scanner .....	231
Sabre 1551E or 1553 Tethered Scanner .....	232
Welch Allyn 1470 Imager Settings .....	232
Error Message .....	232
Scanner Cabling .....	232
Limitations and Capabilities .....	233

# 7 Programming

Creating CAB Files .....	236
Creating Device-Specific CAB Files .....	236
Creating an .INF File .....	236
Sample .INF File .....	245
Using Installation Functions in SETUP.DLL .....	248
After the CAB File Extraction .....	248
Creating CAB Files with CAB Wizard .....	249
Troubleshooting the CAB Wizard .....	250
FTP Server .....	251
Configurable Parameters Via the Registry Editor .....	252
BlockSize .....	252
DeviceName .....	253
DeviceURL .....	253
IDNATarget .....	254
ManifestName .....	254
PauseAtStartup .....	255
Root .....	255
Transferring Files Over TCP/IP Networks .....	256
Stopping the FTP Server from Your Application .....	260
Autostart FTP .....	260
Full Screen .....	262
Kernel I/O Controls .....	264
IOCTL_HAL_GET_DEVICE_INFO .....	264
IOCTL_HAL_ITC_READ_PARM .....	265
IOCTL_HAL_ITC_WRITE_SYSPARM .....	270
IOCTL_HAL_GET_DEVICEID .....	272
IOCTL_HAL_GET_OAL_VERINFO .....	273
IOCTL_HAL_GET_BOOTLOADER_VERINFO .....	274
IOCTL_HAL_WARMBOOT .....	275
IOCTL_HAL_COLDBOOT .....	275
IOCTL_HAL_GET_RESET_INFO .....	276
IOCTL_HAL_GET_BOOT_DEVICE .....	277
IOCTL_HAL_REBOOT .....	278
IOCTL_PROCESSOR_INFORMATION .....	279
IOCTL_GET_CPU_ID .....	280

Reboot Functions ..... 280  
     IOCTL\_HAL\_REBOOT ..... 280  
     IOCTL\_HAL\_COLDBOOT ..... 280  
     IOCTL\_HAL\_WARMBOOT ..... 280

Remapping the Keypad ..... 281  
     Unshifted Plane ..... 281  
     Gold Plane ..... 281  
     Alpha Plane ..... 281  
     Key Values ..... 282  
     How Key Values Are Stored in Registry ..... 282  
     Change Notification ..... 283  
     Advanced Keypad Remapping ..... 283  
     Scan Codes ..... 283  
     Sample View of Registry Keys ..... 284

## **A** Control Panel Applets

Configuration Parameters ..... 286  
     Changing a Parameter Setting ..... 286  
     About Configuration Parameters ..... 287

Data Collection Control Panel Applet ..... 288  
     Symbologies ..... 289  
         Code 39 ..... 290  
         Standard 2 of 5 ..... 291  
         Codabar ..... 292  
         UPC/EAN ..... 293  
         Code 93 ..... 294  
         Code 128 ..... 295  
         Plessey ..... 298  
         MSI ..... 299  
         PDF 417 ..... 300  
         Interleaved 2 of 5 ..... 303  
         Matrix 2 of 5 ..... 304  
         Telepen ..... 305  
         Code 11 ..... 306  
         QR Code ..... 307  
         Data Matrix ..... 308  
     Symbology Options ..... 309  
         Symbology ID ..... 309  
         Prefix ..... 315  
         Suffix ..... 316  
     Beeper/LED ..... 317  
         Beeper Volume ..... 318  
         Beeper Frequency ..... 320  
         Good Read Beeps ..... 321  
         Good Read Beep Duration ..... 322  
     Imager ..... 323  
         Aimer LED duration ..... 323  
         Image Dimension ..... 324

## Contents

Virtual Wedge	325
Virtual Wedge	325
Preamble	326
Postamble	327
Grid	328
Code Page	329
SNMP Control Panel Applet	330
Security	331
Read Only Community	331
Read/Write Community	332
Read Encryption	333
Write Encryption	334
Encryption Key	335
Traps	336
Authentication	336
Threshold	337
Identification	338
Contact	338
Name	339
Location	340
Unit Information Control Panel Applet	341
Versions	342
Battery Status	343
CAB Files	344

## **B** Unit Manager

Data Collection	348
Symbologies	348
Symbology ID	349
Beeper/LED	349
Imager	350
Virtual Wedge	350
SNMP	350
Security	350
Traps	351
Identification	351
Unit	352
Date/Time	352
Backlight Timeout	353
Key Clicks	354
Automatic Shutoff	355
Volume	356
Using Reader Commands	357
Change Configuration	357
Set Time and Date	358

## C Bar Codes

Bar Code Symbolologies .....	360
UPC .....	362
EAN .....	362
Codabar .....	362
Code 11 .....	363
Code 39 .....	363
Encoded Code 39 (Concatenation) .....	363
Encoded Code 39 (Full ASCII) .....	363
Code 93 .....	364
Code 128 .....	364
I 2 of 5 (Interleaved) .....	366
S 2 of 5 (Standard 2 of 5) .....	366
Plessey .....	367
MSI Code (Variant of Plessey) .....	367
Bar Code Labels .....	368
Audio Volume .....	368
Automatic Shutoff .....	369
Backlight Timeout .....	369
Key Clicks .....	370
Virtual Wedge Grid, Preamble, Postamble .....	371
Grid .....	371
Preamble .....	371
Postamble .....	371

## I Index

Classes and Functions .....	374
General Index .....	377
Files Index .....	398

**Contents**



## Before You Begin

This section introduces you to standard warranty provisions, safety precautions, warnings and cautions, document formatting conventions, and sources of additional product information. A documentation roadmap is also provided to guide you in finding the appropriate information.

### Warranty Information

To receive a copy of the standard warranty provision for this product, contact your local Intermec support services organization. In the U.S. call 1-800-755-5505, and in Canada call 1-800-668-7043. If you live outside of the U.S. or Canada, you can find your local Intermec support services organization on the Intermec Web site at [www.intermec.com](http://www.intermec.com).



**Note:** Opening this product may void the warranty. The internal workings of this product can only be accessed by Intermec service personnel. Radio replacements and upgrades require Intermec service personnel.

### Safety Summary

Your safety is extremely important. Follow these guidelines:

- Read and follow all warnings and cautions in this book before handling and operating Intermec equipment. You can be seriously injured, and equipment and data can be damaged if you do not follow the safety warnings and cautions.
- Do not repair or adjust energized equipment alone under any circumstances. Someone capable of providing first aid must always be present for your safety.
- Always obtain first aid or medical attention immediately after an injury. Never neglect an injury, no matter how slight it seems.
- Begin resuscitation immediately if someone is injured and stops breathing. Any delay could result in death. To work on or near high voltage, you should be familiar with approved industrial first aid methods.
- Never work on energized equipment unless authorized by a responsible authority. Energized electrical equipment is dangerous. Electrical shock from energized equipment can cause death. If you must perform authorized emergency work on energized equipment, be sure that you comply strictly with approved safety regulations.

## Warnings, Cautions, and Notes



The warnings, cautions, and notes in this manual use this format:

A warning alerts you of an operating procedure, practice, condition, or statement that must be strictly observed to avoid death or serious injury to the persons working on the equipment.

**Attention Danger:** Un avertissement vous avertit d'une procédure de fonctionnement, d'une méthode, d'un état ou d'un rapport qui doit être strictement respecté pour éviter l'occurrence de mort ou de blessures graves aux personnes manipulant l'équipement.



A caution alerts you to an operating procedure, practice, condition, or statement that must be strictly observed to prevent equipment damage or destruction, or corruption or loss of data.

**Attention:** Une précaution vous avertit d'une procédure de fonctionnement, d'une méthode, d'un état ou d'un rapport qui doit être strictement respecté pour empêcher l'endommagement ou la destruction de l'équipement, ou l'altération ou la perte de données.



**Note:** Notes are statements that either provide extra information about a topic or contain special instructions for handling a particular condition or set of circumstances.

## About This Manual

The *700 Series Color Mobile Computer User's Manual* provides you with information about the features of the 700 Series Color Mobile Computer and how to configure, troubleshoot, and support it. You must be familiar with your host PC, your network, and your other Intermecc equipment.

- **Chapter 1 — Introduction**  
Introduces the 700 Series Color Mobile Computer.
- **Chapter 2 — Pocket PC 2002**  
Introduces the Pocket PC 2002 operating system from Microsoft Corporation, and explains how to use its Outlook, ActiveSync, Internet Explorer, and other companion programs.
- **Chapter 3 — Installing Applications**  
Provides methods to install applications and CAB files, also covers application migration.
- **Chapter 4 — Network Support**  
Introduces the CORE application, network adapters such as Ethernet, 802.11b radios, GSM/GPRS or CDMA/1xRTT embedded radio modules, and wireless printing equipped with a Bluetooth module, SNMP configuration, and Network Selection APIs.
- **Chapter 5 — Printer Support**  
Provides information on printing ASCII to either a port or to a generic serial port, and on working with IrDA, NPCP, and O'Neil printer drivers.

- **Chapter 6 — Scanner Support**  
Provides Automatic Data Collection COM and IImage interfaces and lists settings via Data Collection parameters.
- **Chapter 7 — Programming**  
Programming information that includes creating CAB files, the FTP Server, Full Screen, Kernel I/O Control Functions, Reboot Functions, and remapping the keypad.
- **Appendix A — Control Panel Applets**  
Contains detailed information about the Data Collection, SNMP, and Unit Information control panel applets.
- **Appendix B — Unit Manager**  
Describes how to configure some parameters via the Unit Manager application and includes reader commands.
- **Appendix C — Bar Codes**  
Describes some of the more common bar code symbologies and includes bar code labels that can be scanned to configure your 700 Series Computer.

## Format Conventions for Input From a Keyboard or Keypad

This table describes the formatting conventions for input from PC or host computer keyboards and device keypads.

### Format Conventions

Convention	Description
Special text	Shows the command as you should enter it into the device.
<i>Italic text</i>	Indicates a variable that you must replace the parameter with a value.
<b>Bold text</b>	Indicates the keys you must press on a PC or host computer keyboard. For example, “press <b>Enter</b> ” means you press the key labeled “Enter” on the PC or host computer keyboard.
where	This word introduces a list of parameters and explains the values you can specify for them.

## **Related Publications**

To order printed versions of the Intermec manuals, contact your local Intermec representative or distributor. Following are related Intermec manuals, CD-ROMs, and part numbers (P/N). For other versions and languages, consult your Intermec sales representative.

- *700 Series Color Mobile Computer Quick Start Guide*  
(P/N: 962-054-053)
- *700 Color Recovery CD PPC 2002 Professional Edition WWE*  
(P/N: 235-100-001 Kit)
- *700 Color Recovery CD PPC 2002 Premium Edition WWE*  
(P/N: 235-101-001 Kit)
- *700 Series Color Software Tools CD* (P/N: 235-099-001)
- *Windows 95 and Windows CE Configuration Utilities Reference Manual*  
(P/N: 978-054-010)

## **Global Services and Support**

Select any of the following services available from Intermec Technologies Corporation:

- **Factory Repair and On-site Repair**  
To request a return authorization number for one of our authorized service centers, or to request an on-site repair technician, call 1-800-755-5505, then select option 1.
- **Technical Support**  
For technical support on your Intermec product, call 1-800-755-5505, then select option 2.
- **Service Contract Status**  
To inquire about an existing contract, or to renew a contract, call 1-800-755-5505, then select option 3.
- **Schedule Site Surveys or Installations**  
To schedule a site survey, or to request a product or system installation, call 1-800-755-5505, then select option 4.

## **Web Support**

Visit our Web site at <http://www.intermec.com> to download many of our current manuals in PDF format.

Visit our technical knowledge base (Knowledge Central) at <http://intermec.custhelp.com> to review technical information or to request technical help for all Intermec products.



# **1 Introduction**

This chapter introduces the 700 Series Color (700C) Mobile Computer, developed by Intermec Technologies Corporation to enhance wireless connectivity needs.

# About the 700 Series Color Mobile Computer

## Audio System

### Speaker

A speaker capable of variable volume levels is located on the back of the computer. This speaker has a transducer volume of 85 dB min at 10 CM and a frequency range of 1-8 KHz.

### Internal Microphone

The internal microphone is located on the bottom of the unit to the left of the Hirose connector.

### External Headset Jack

The external headset jack connects a mono headset to your mobile computer for use in noisy environments. The jack is a 2.5 mm, three-conductor jack, with autosensing of the headset jack insertion which disables the internal speaker and microphone. The external headset jack is located on the bottom of the mobile computer to the right of the Hirose connector.

## Battery



The 700 Series Computer comes equipped with a nominal 14.4 Watt-hour, 7.2V (two 2000 mAh cells), replaceable Lithium-Ion (LiIon) battery. To view the status of this battery from the 700 Series Computer, tap **Start** → **Settings** → the **System** tab → the **Power** icon to view the current status of both the main battery and the backup battery. Tap **ok** to exit this information.

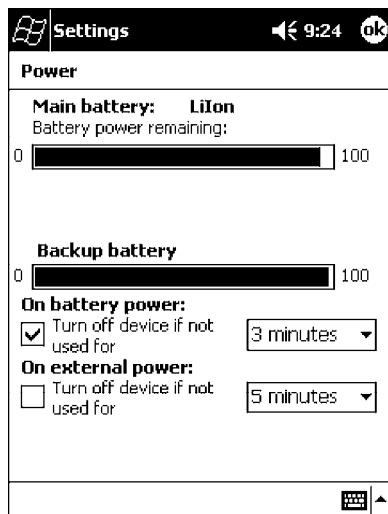



**Note:** The **Unit Information** control panel applet is only available in the 700 Series Computer if Intermecc Content is enabled, the Plus region is enabled and installed, and a laser scanner is installed.



You can also view the battery status for the 700 Series Computer by accessing the **Unit Information** control panel applet. Tap the **Unit Information** icon, then tap the **Battery Status** tab to view the current status. Tap **ok** to exit this information.

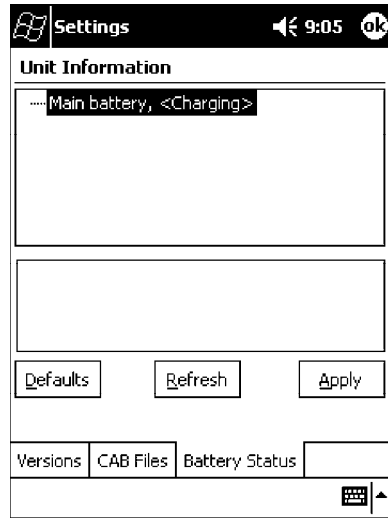

### Low Battery Shutdown

If your computer shuts down because of low battery conditions, your computer will not operate. This is done to ensure that data is protected. Although the battery will protect the data against loss for several hours, you should connect your computer to a power source when you first detect a low battery condition.

Your computer contains an internal super capacitor, a temporary power storage device, that protects data for up to ten minutes. This is to give you time to replace the main battery pack before that data is lost. *Be sure to put the computer in a suspend mode before doing so.*

The battery power fail level is set so that after the system shuts down in a low battery condition, there is still sufficient charge to allow the unit to remain configured, keep proper time, and maintain DRAM (Dynamic Random Access Memory) for at least 72 hours at room temperature *if* the main battery remains in the mobile computer. The configuration and time are lost if:

- The battery discharges beyond this level.
- The battery is removed when the computer is *not in suspend mode*.
- A cold reset is performed on the computer.

### System Status Maintained

System status is maintained in “suspend” when the main battery is removed:

- 10 minutes for 64 MB low-power chips
- 5 minutes for 128 MB low-power chips

### CAB Files Within 700C Software Tools CD

If you leave the default destination while you install the “\700 Color Mgmt Tools” directory onto your desktop PC, then “C:\Intermec\Intermec 700 Color Mgmt Tools\Cab Files” will be the default directory. There are folders within the “\Cab Files” directory that contain demos and program files. See the *700 Series Color Software Tools CD User’s Manual* for more information about these files.

### Modem Support

Modem PC Cards are not supported by the 700 Series Computer. However, modem options do include the following:

- Switchable dock that includes a built-in modem and a serial port between which an application can switch.
- Mini-Landline Modem that can be tethered to the port on the bottom of the 700 Series Computer.
- Other external modems that may be connected to the bottom of the 700 Series Computer or to the dock.

### Network Support

Radio CompactFlash Cards cannot be installed by a user. The 700 Series Computer must be serviced to install or replace radios. See Chapter 4, “*Network Support*” for more information.

- 802.11b radio
- Integrated GSM/GPRS radio
- CDPM/1xRTT radio
- Wireless printing equipped with a Bluetooth qualified module by Socket Communications



## Removeable Card Support

To access either the CompactFlash (CF) or SecureDigital (SD) card slot, locate the access door at the top of the 700 Series Computer, remove its two screws, then remove the door.

### CompactFlash Cards

Support is limited to one CompactFlash (CF) Storage Card in the 700 Series Computer, either for storage or for the 802.11b radio.

### SecureDigital Cards

Support is limited to one SecureDigital (SD) Storage Card in the 700 Series Computer for storage.

### MultiMediaCards

MultiMediaCards (MMCs) are not supported in the 700 Series Computers because current technology shows that SD cards will quickly surpass MMC cards in storage capacity.

## Software Build Version

To check to see if your 700 Series Computer has the latest build, select **Start** → **Internet Explorer** → the **Intermec** logo.



The latest software build version is displayed beneath the **Patent Information** title. This information will be useful should you need customer assistance.

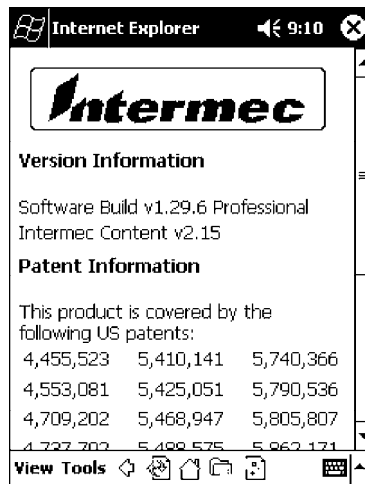

**Note:** The **Unit Information** control panel applet is only available in the 700 Series Computer if Intermec Content is enabled, the Plus region is enabled and installed, and a laser scanner is installed.



You can also view the latest software build version on your 700 Series Computer by accessing the **Unit Information** control panel applet. Select **Start** → **Settings** → the **System** tab → the **Unit Information** icon → the **Versions** tab to view the current build version on your 700 Series Computer.

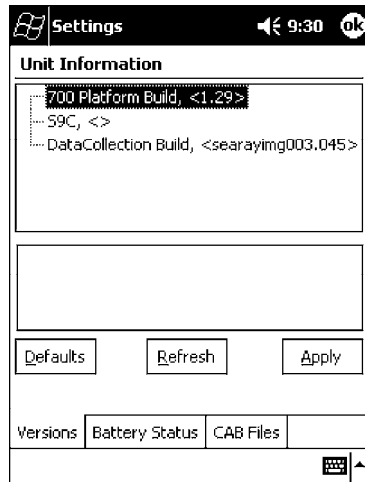

## What's New

The newest functionality is available in software build versions 1.30 or greater. The following changes have occurred since the last release of this manual:

- Applied new publications standards to this manual.
- Adapted instructions using Ethernet connections to fit Intermec requirements in Chapter 2, “*Pocket PC 2002*.”
- Moved “*Updating System Software*” and “*EFlash*” information to the *Recovery CD User's Manual* from Chapter 3, “*Installing Applications*.”
- Removed several 802.11 APIs not related to the 700 Series Color Computer from Chapter 4, “*Network Support*.”
- Added the Siemens MC45 radio module to Chapter 4, “*Network Support*.”
- Added tethered scanner information to Chapter 6, “*Scanner Support*.”
- Added CAB extraction information and FTP Server parameters to Chapter 7, “*Programming*.”
- Added imager option information via the Data Collection control panel applet to Appendix A, “*Control Panel Applets*.” *Note that this is for 700 Series Computers using an imager.*



## **2** Pocket PC 2002

This chapter introduces the Pocket PC 2002 operating system from Microsoft Corporation.

## Introduction

Congratulations on purchasing a Pocket PC. Due to the size and capabilities of this 700 Series Color Mobile Computer, you can keep your most important business and personal information up-to-date and close at hand. Microsoft ActiveSync increases the power of your 700 Series Computer by allowing you to synchronize the information on your desktop or laptop computer with your 700 Series Computer. Picture yourself in the following situations:

- A Calendar reminder alerts you that it is time to catch the bus. You grab your 700 Color Pocket PC Mobile Computer and catch the bus just in time. Because ActiveSync keeps the information on your 700 Series Computer up-to-date, you leisurely review your task list, make notes about the new books and CDs you want to buy, and read and respond to e-mail messages. When you get back to the office, ActiveSync transfers any task changes you made, your notes, and your e-mail message responses to your desktop computer. For more information on ActiveSync, see “*Microsoft ActiveSync*” on page 29.
- While walking with a colleague, your 700 Color Pocket PC Mobile Computer rings. You look at the caller ID and see it is your manager who is calling. She asks if you two are free this afternoon for an emergency meeting. While your colleague fumbles through his paper organizer, you press a button on your 700 Series Computer and instantly see a list of today’s appointments and meetings. You are quickly able to tell your manager your available times, and make a note of the new meeting while on the call. You hang up, send an e-mail with a schedule request for the three of you at the desired location. For more information on scheduling appointments and meetings, see “*Microsoft Pocket Outlook*” on page 31.
- You are meeting your friends tonight for dinner and a movie. You download the latest movie information from the Internet to your desktop computer and then synchronize it with your 700 Series Computer. At dinner, you pull out your 700 Color Pocket PC Mobile Computer and review your movie options with your friends. For more information on downloading Web pages to your 700 Series Computer, see “*Pocket Internet Explorer*” on page 62.

## Premium versus Professional Editions

Your 700 Series Computer will have either the Premium Edition or the Professional Edition of Pocket PC 2002. Do the following to determine which edition of Pocket PC 2002 is on your unit.

- 1 Select **Start** → **Internet Explorer** → the **Intermec** logo.



2 Note the “Software Build” information displayed beneath the **Version Information** title.



**Note:** If you have an older software build, your unit may say either “PREM” (which indicates the Premium Edition) or “PRO” (which indicates the Professional Edition).

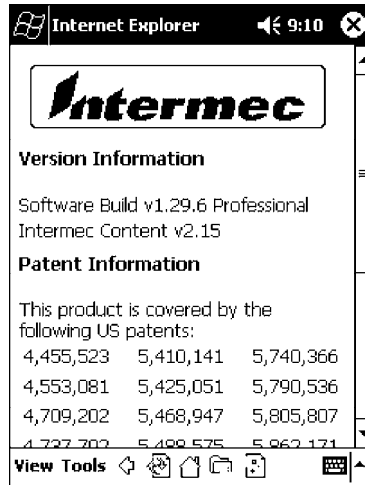

3 Tap the **Close** icon in the top right corner to exit the Internet Explorer.

Below is a list of components for each edition of Pocket PC 2002:

Component	Premium Edition	Professional Edition
Microsoft ActiveSync Client (page 29)	X	X
Microsoft Pocket Outlook (page 31)	X	X
Pocket Word (page 47)	X	X
Pocket Excel (page 52)	X	X
MSN Messenger (page 53)	X	
Windows Media Player for Pocket PC (page 57)	X	RAM
Microsoft Reader (page 58)	X	RAM
Pocket Internet Explorer (page 62)	X	X



**Note:** Components marked with “RAM” are provided on a Companion CD for download into RAM rather than burned into Flash ROM.

## Where to Find Information

This chapter describes your 700 Series Computer hardware, provides an overview of the programs on your 700 Series Computer, and explains how to connect your 700 Series Computer to a desktop computer, a network, or the Internet. For instructions on setting up your 700 Series Computer and installing ActiveSync, see the Quick Start Card. The following is a guide to more information to assist you use your 700 Series Computer.

For information on:	See this source:
Programs on your mobile computer.	This chapter and mobile computer Help. To view Help, tap <b>Start</b> → <b>Help</b> .
Additional programs that can be installed on the mobile computer.	The Pocket PC Companion CD.
Connecting to and synchronizing with a desktop computer.	The Quick Start Card or <i>AutoSync Help</i> on your desktop computer. To view Help, click <b>Help</b> → <b>Microsoft ActiveSync Help</b> .
Last-minute updates and detailed technical information.	The Read Me files, located in the Microsoft ActiveSync folder on the desktop computer and on the Pocket PC Companion CD.
Up-to-date information on your Pocket PC.	<a href="http://www.microsoft.com/mobile/pocketpc">http://www.microsoft.com/mobile/pocketpc</a>

Pocket PC and many of the technologies supported by the 700 Series Computer are not from Intermec Technologies. Many of the utilities and features on a Pocket PC device come directly from Microsoft without any modification from Intermec Technologies. There may be certain Microsoft-specific issues that Intermec Technologies would not be able to support, so you will have to contact Microsoft Corporation. Use these URLs to determine your Microsoft support options:

- <http://msdn.microsoft.com/support/>
- <http://support.microsoft.com/>
- <news://news.microsoft.com> (a free support option)

## Basic Skills

Learning to use your 700 Series Computer is easy. This describes the basic concepts of using and customizing your 700 Series Computer.

### Buttons and Stylus

Your 700 Series Computer has hardware buttons that control actions and scroll functions, and a stylus for selecting items and entering information. On the 700 Series Computer, the stylus replaces the mouse.

- **Tap:**  
Touch the screen once with the stylus to open items and select options.
- **Drag:**  
Hold the stylus on the screen and drag across the screen to select text and images. Drag in a list to select multiple items.
- **Tap and hold:**  
Tap and hold the stylus on an item to see a list of actions available for that item. On the pop-up menu that appears, tap the action to be performed.

### Today Screen



When you turn on your 700 Series Computer for the first time each day (or after four hours of inactivity), you will see the **Today** screen. You can also display it by tapping the **Start** flag (shown left) and then **Today**. On the **Today** screen, you can see at a glance important information for the day.

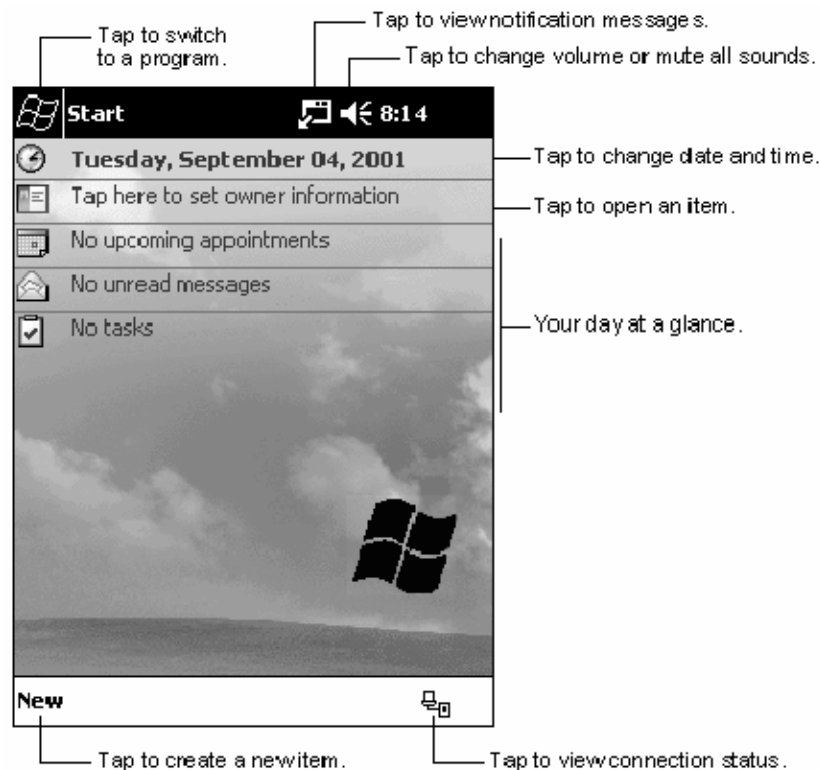

Following are some of the status icons you may see:

Status Icon    Meaning:



Turns all sounds on and off.



Backup battery is low.



Main batteries are charging.



Main batteries are low.



Main batteries are very low.



Main batteries are full.



Connection is active.



Synchronization is beginning or ending.



Synchronization is occurring.



Notification or one or more instant messages received.



Notification of one or more e-mail messages received.



If more notification icons need to be displayed than there is room to display them, the **Notification** icon (*shown left*) will display. Tap the icon to view all notification icons.



## Programs

You can switch from one program to another by selecting it from the **Start** menu. (You can customize which programs you see on this menu. For information, see “*Adjusting Settings*” on page 26.) To access some programs, tap **Start** → **Programs**, and then the program name.

You can also switch to some programs by pressing a program button. Your 700 Series Computer has one or more program buttons located on the front or side of the computer. The icons on the buttons identify the programs to which they switch.



**Note:** Some programs have abbreviated labels for check boxes and drop-down menus. To see the full spelling of an abbreviated label, tap and hold the stylus on the label. Drag the stylus off the label so that the command is not carried out.

The following is a partial list of programs that are on your 700 Series Computer. Look on the Pocket PC Companion CD for additional programs that you can install onto your 700 Series Computer.



### ActiveSync

Synchronize information between your 700 Series Computer and desktop computer.



### Calendar

Keep track of your appointments and create meeting requests.



### Contacts

Keep track of your friends and colleagues.



### Inbox

Send and receive e-mail messages.



### Pocket Internet Explorer

Browse Web and WAP (Wireless Application Protocol) sites, and download new programs and files from the Internet.



### Notes

Create handwritten or typed notes, drawings, and recordings.



### Tasks

Keep track of your tasks.



### Pocket Excel

Create new workbooks or view and edit Excel workbooks created on your desktop computer.



### MSN Messenger

Send and receive instant messages with your MSN Messenger contacts.



### Pocket Word

Create new documents or view and edit Word documents created on your desktop computer.

## Navigation Bar and Command Bar

The navigation bar is located at the top of the screen. It displays the active program and current time, and allows you to switch to programs and close screens.

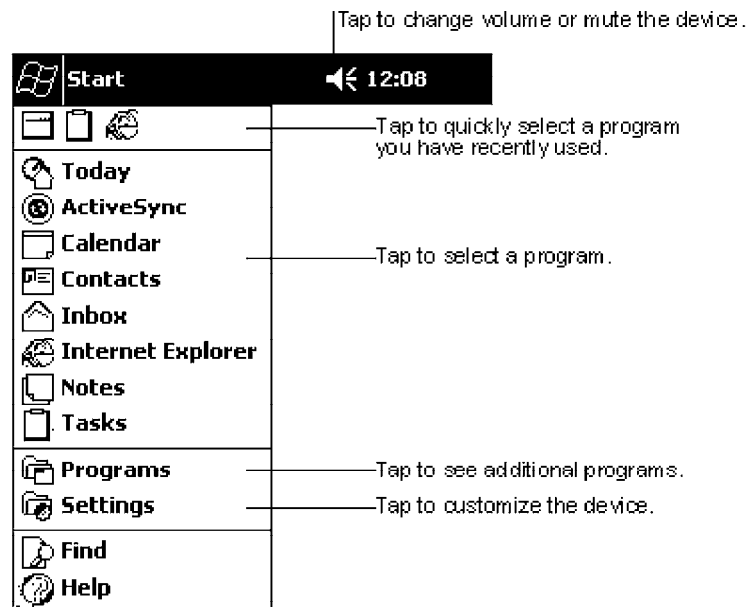

Use the command bar at the bottom of the screen to perform tasks in programs. The command bar includes menu names, buttons, and the **Input Panel** button. To create a new item in the current program, tap **New**. To see the name of a button, tap and hold the stylus on the button. Drag the stylus off the button so that the command is not carried out.

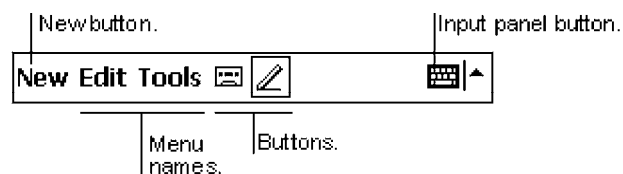

## Pop-up Menus

With pop-up menus, you can quickly choose an action for an item. For example, you can use the pop-up menu in the contact list to quickly delete a contact, make a copy of a contact, or send an e-mail message to a contact. The actions in the pop-up menus vary from program to program. To access a pop-up menu, tap and hold the stylus on the item name that you want to perform the action on. When the menu appears, lift the stylus, and tap the action you want to perform. Or tap anywhere outside the menu to close the menu without performing an action.

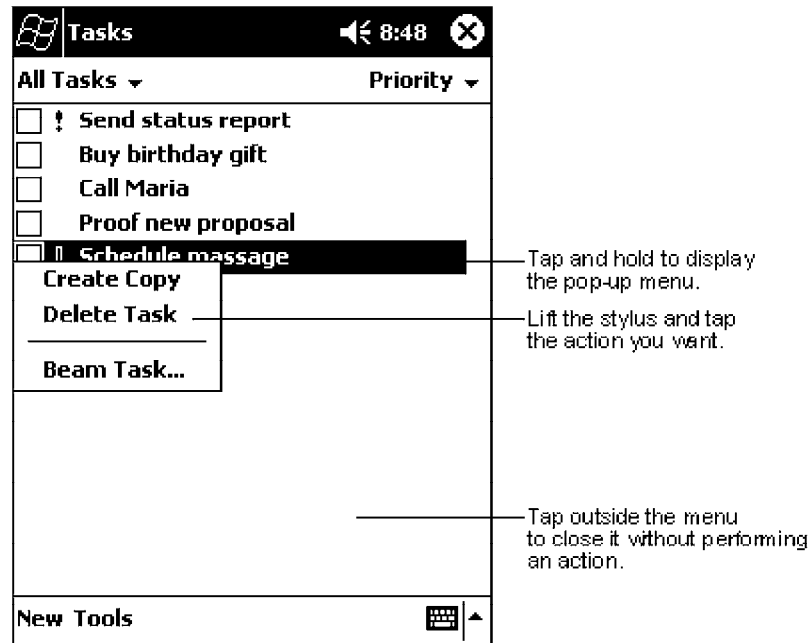

## Notifications

Your 700 Series Computer reminds you in a variety of ways when you have something to do. For example, if you have set up an appointment in Calendar, a task with a due date in Tasks, or an alarm in Clock, you will be notified in any of the following ways:

- A message box appears on the screen.
- A sound, which you can specify, is played.
- A light flashes on your 700 Series Computer.
- A vibrator resonates from the 700 Series Computer.

To choose reminder types and sounds for your 700 Series Computer, tap **Start** → **Settings** → the **Personal** tab → **Sounds & Notifications**. The options you choose here apply throughout the 700 Series Computer.

## Enter Information on Your 700 Series Computer

You have several options for entering new information:

- Use the input panel to enter typed text, either by using the soft keyboard or other input method.
- Write directly on the screen.
- Draw pictures on the screen.
- Speak into your 700 Series Computer microphone to record a message.
- Use Microsoft ActiveSync to synchronize or copy information from your desktop computer to your 700 Series Computer. For more information on ActiveSync, see *ActiveSync Help* on your desktop computer.

Use the input panel to enter information in any program on your 700 Series Computer. You can either type using the soft keyboard or write using **Block Recognizer**, **Letter Recognizer**, or **Transcriber**. In either case, the characters appear as typed text on the screen.

To show or hide the input panel, tap the **Input Panel** button. Tap the arrow next to the **Input Panel** button to see your choices.

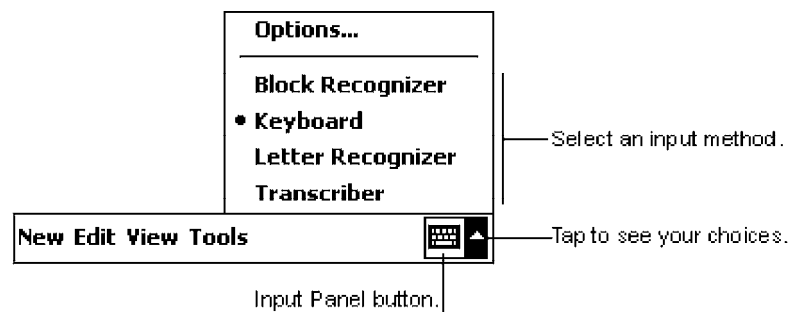

When you use the input panel, your 700 Series Computer anticipates the word you are typing or writing and displays it above the input panel. When you tap the displayed word, it is inserted into your text at the insertion point. The more you use your 700 Series Computer, the more words it learns to anticipate.

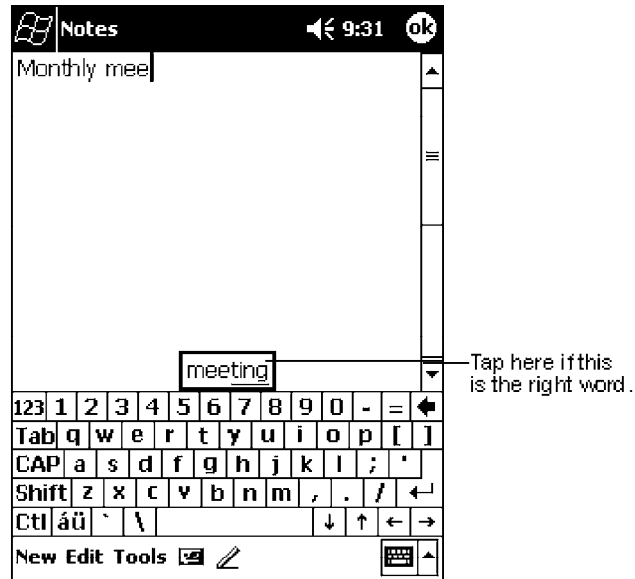

**Note:** To change word suggestion options, such as the number of words suggested at one time, tap **Start** → **Settings** → the **Personal** tab → **Input** → the **Word Completion** tab.

### Typing With the Soft Keyboard

- 1 Tap the arrow next to the **Input Panel** button, and then **Keyboard**.
- 2 On the soft keyboard that is displayed, tap the keys with your stylus.

### Using Block Recognizer

With Block Recognizer, you can input character strokes using the stylus that are similar to those used on other 700 Series Computers.

- 1 Tap the arrow next to the **Input Panel** button, then **Block Recognizer**.
- 2 Write a letter in the box.

When you write a letter, it is converted to typed text that appears on the screen. For specific instructions on using Block Recognizer, with Block Recognizer open, tap the question mark next to the writing area.

### Using Letter Recognizer

With Letter Recognizer, you can write letters using the stylus just as you would on paper.

- 1 Tap the arrow next to the **Input Panel** button, then **Letter Recognizer**.
- 2 Write a letter in the box.

When you write a letter, it is converted to typed text that appears on the screen. For specific instructions on using Letter Recognizer, with Letter Recognizer open, tap the question mark next to the writing area.

### Using Transcriber

With Transcriber, you can write anywhere on the screen using the stylus just as you would on paper. Unlike Letter Recognizer and Block Recognizer, you can write a sentence or more of information. Then, pause and let Transcriber change the written characters to typed characters.

- 1 Tap the arrow next to the **Input Panel** button, and then **Transcriber**.
- 2 Write anywhere on the screen.

For specific instructions on using Transcriber, with Transcriber open, tap the question mark in the lower right hand corner of the screen.

### Selecting Typed Text

If you want to edit or format typed text, you must select it first.

- Drag the stylus across the text you want to select.

You can cut, copy, and paste text by tapping and holding the selected words and then tapping an editing command on the pop-up menu, or by tapping the command on the **Edit** menu.

## Writing on the Screen

In any program that accepts writing, such as the Notes program, and in the **Notes** tab in Calendar, Contacts, and Tasks, you can use your stylus to write directly on the screen. Write the way you do on paper. You can edit and format what you have written and convert the information to text at a later time.

- Tap the **Pen** button to switch to writing mode. This action displays lines on the screen to help you write.

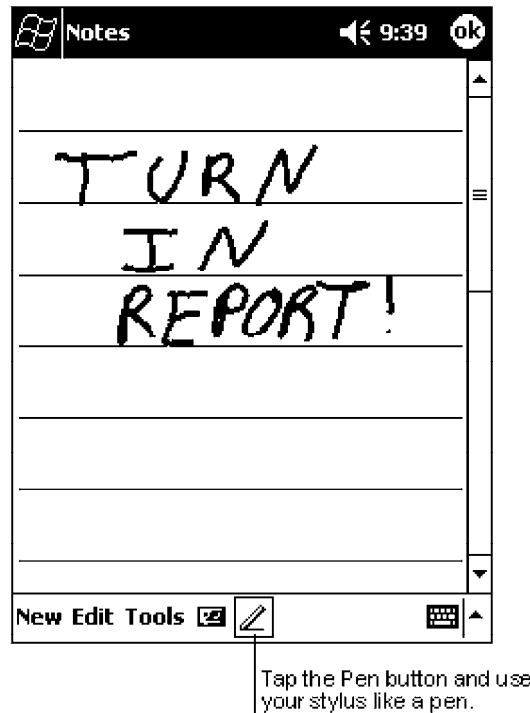

**Note:** Some programs that accept writing may not have the **Pen** button. See the documentation for that program to find out how to switch to writing mode.

### Selecting the Writing

If you want to edit or format writing, you must select it first.

- 1 Tap and hold the stylus next to the text you want to select until the insertion point appears.
- 2 Without lifting, drag the stylus across the text you want to select.

If you accidentally write on the screen, tap **Tools** → **Undo** and try again. You can also select text by tapping the **Pen** button to deselect it and then dragging the stylus across the screen.

You can cut, copy, and paste written text in the same way you work with typed text: tap and hold the selected words and then tap an editing command on the pop-up menu, or tap the command on the **Edit** menu.

### Converting Writing to Text

- Tap Tools → Recognize.

If you want to convert only certain words, select them before tapping **Recognize** on the **Tools** menu (or tap and hold the selected words and then tap **Recognize** on the pop-up menu). If a word is not recognized, it is left as writing.

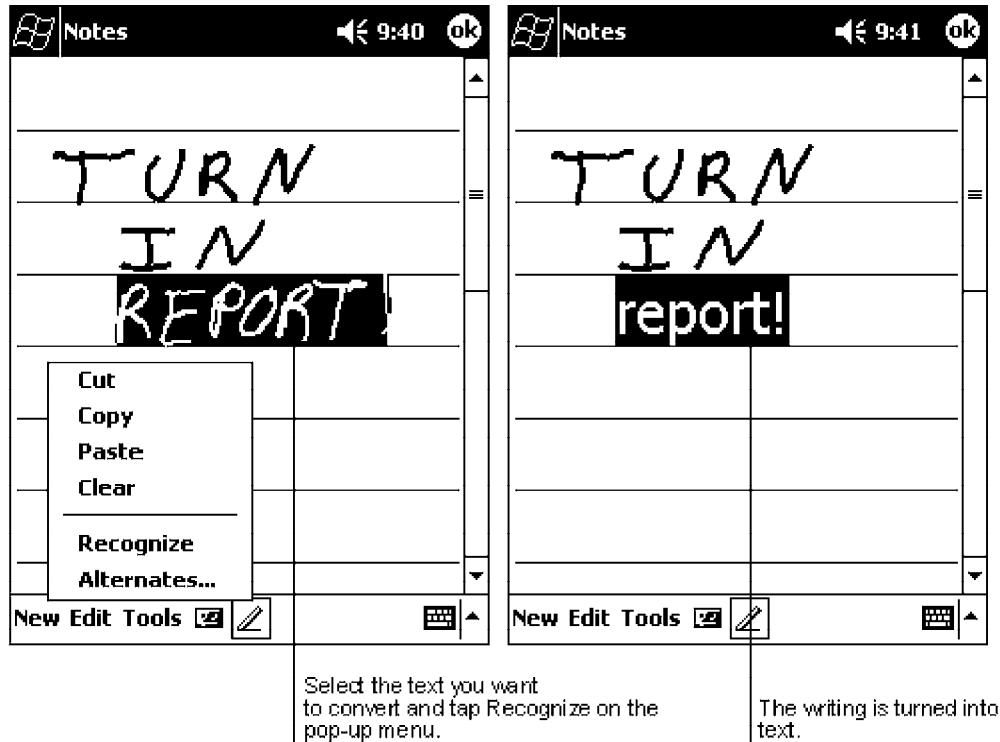



If the conversion is incorrect, you can select different words from a list of alternates or return to the original writing. To do so, tap and hold the incorrect word (tap one word at a time). On the pop-up menu, tap **Alternates**. A menu with a list of alternate words appears. Tap the word you want to use, or tap the writing at the top of the menu to return to the original writing.

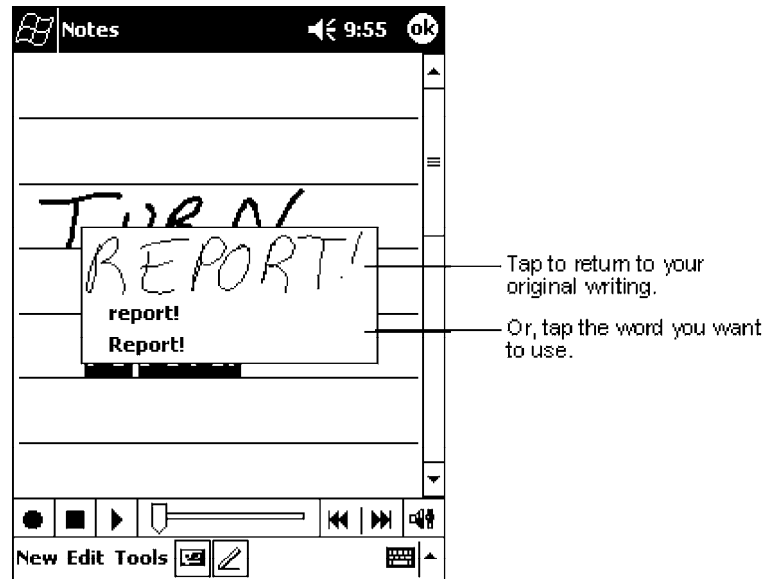

Tips for getting good recognition:

- Write neatly.
- Write on the lines and draw descenders below the line. Write the cross of the “t” and apostrophes below the top line so that they are not confused with the word above. Write periods and commas above the line.
- For better recognition, try increasing the zoom level to 300% using the **Tools** menu.
- Write the letters of a word closely and leave big gaps between words so that the 700 Series Computer can easily tell where words begin and end.
- Hyphenated words, foreign words that use special characters such as accents, and some punctuation cannot be converted.
- If you add writing to a word to change it (such as changing a “3” to an “8”) after you attempt to recognize the word, the writing you add will not be included if you attempt to recognize the writing again.

## Drawing on the Screen

You can draw on the screen in the same way that you write on the screen. The difference between writing and drawing on the screen is how you select items and how they can be edited. For example, selected drawings can be resized, while writing cannot.

### Creating a Drawing

- Cross three ruled lines on your first stroke. A drawing box appears. Subsequent strokes in or touching the drawing box become part of the drawing. Drawings that do not cross three ruled lines will be treated as writing.

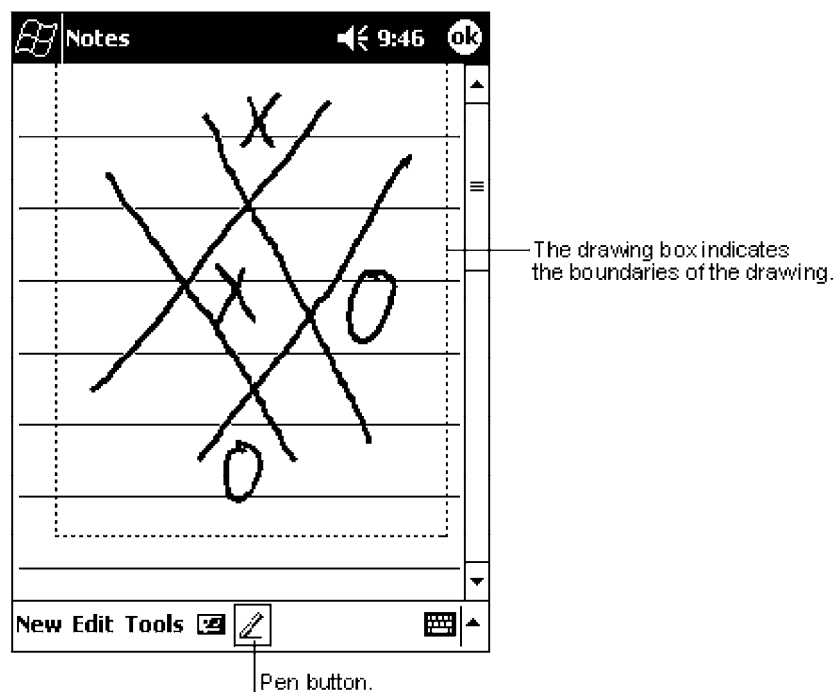

**Note:** You may want to change the zoom level so that you can more easily work on or view your drawing. Tap **Tools** and then a zoom level.

### Selecting a Drawing

If you want to edit or format a drawing, you must select it first.

- Tap and hold the stylus on the drawing until the selection handle appears. To select multiple drawings, deselect the **Pen** button and then drag to select the drawings you want.

You can cut, copy, and paste selected drawings by tapping and holding the selected drawing and then tapping an editing command on the pop-up menu, or by tapping the command on the **Edit** menu. To resize a drawing, make sure the **Pen** button is not selected, and drag a selection handle.

## Recording a Message

In any program where you can write or draw on the screen, you can also quickly capture thoughts, reminders, and phone numbers by recording a message. In Calendar, Tasks, and Contacts, you can include a recording in the **Notes** tab. In the Notes program, you can create a stand-alone recording or include a recording in a written note. If you want to include the recording in a note, open the note first. In the Inbox program, you can add a recording to an e-mail message.

### Creating a Recording

- 1 Hold your computer's microphone near your mouth or source of sound.
- 2 Press and hold the **Record** hardware button on your 700 Series Computer until you hear a beep.
- 3 While holding down the **Record** button, make your recording.
- 4 To stop recording, release the **Record** button. Two beeps will sound. The new recording appears in the note list or as an embedded icon.



**Note:** You can also make a recording by tapping the **Record** button on the Recording toolbar.

To play a recording, tap it in the list or tap its icon in the note.

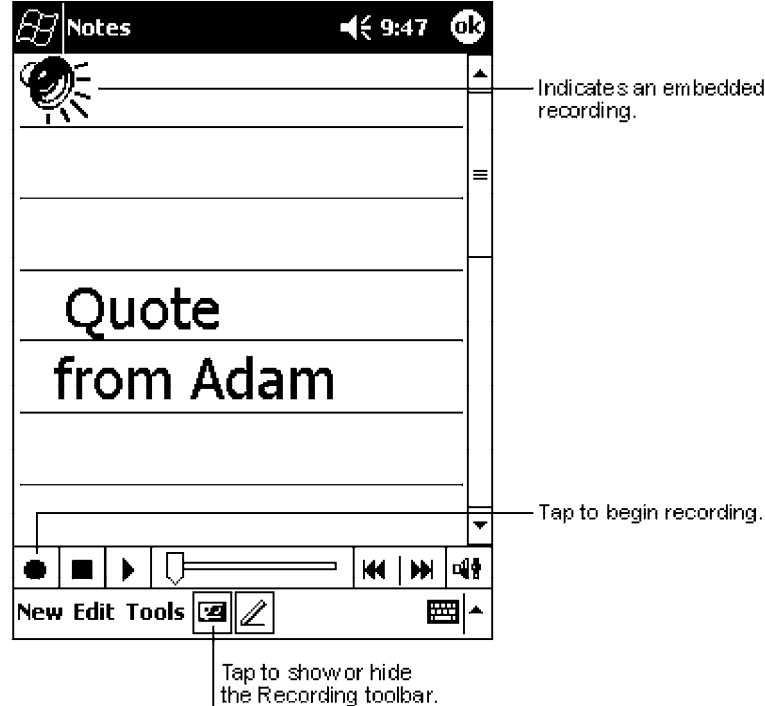

## Using My Text

When using Inbox or MSN Messenger, use **My Text** to quickly insert preset or frequently used messages into the text entry area. To insert a message, tap **My Text** and tap a message.



**Note:** You can add text after inserting a **My Text** message before sending it.

To edit a **My Text** message, in the **Tools** menu, tap **Edit** → **My Text Messages**. Select the message you wish to edit and make desired changes.

## Finding and Organizing Information

The **Find** feature on your 700 Series Computer helps you quickly locate information.

Tap **Start** → **Find**. Enter the text you want to find, select a data type, and then tap **Go** to initiate the search.



**Note:** To quickly find information that is taking up storage space on your 700 Series Computer, select **Larger than 64 KB** in **Type**.

You can also use the File Explorer to find files on your 700 Series Computer and to organize these files into folders. Tap **Start** → **Programs** → **File Explorer**.

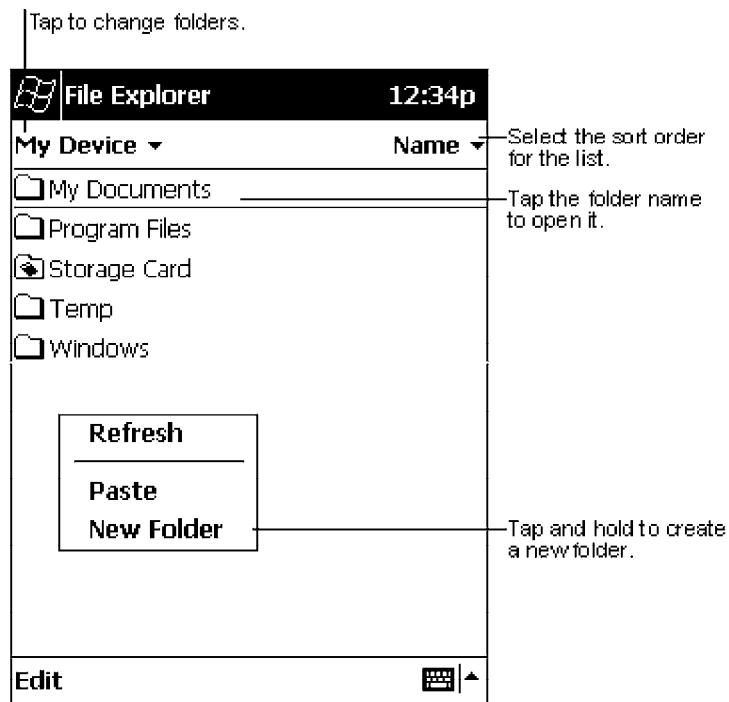

**Note:** You can move files in File Explorer by tapping and holding the item you want to move, and then tapping **Cut** or **Copy** and **Paste** on the pop-up menu.

## Customizing Your 700 Series Computer

You can customize your 700 Series Computer by adjusting settings and installing additional software.

### Adjusting Settings

You can adjust settings to suit the way you work. To see available options, tap **Start** → **Settings** → either the **Personal** tab or the **System** tab located at the bottom of the screen. You might want to adjust the following:

- **Clock:**  
To change the time or to set alarms.
- **Menus:**  
To customize what appears on the **Start** menu, and to enable a pop-up menu from the **New** button.
- **Owner Information:**  
To enter your contact information.
- **Password:**  
To limit access to your 700 Series Computer.
- **Power:**  
To maximize battery life.
- **Today:**  
To customize the look and information displayed on the **Today** screen.

### Adding or Removing Programs

Programs added to your 700 Series Computer at the factory are stored in ROM (Read Only Memory). You cannot remove this software, and you will never accidentally lose ROM contents. ROM programs can be updated using special installation programs with a \*.XIP extension. All other programs and data files added to your 700 Series Computer after factory installation are stored in RAM (Random Access Memory).

You can install any program created for your 700 Series Computer, as long as your 700 Series Computer has enough memory. The most popular place to find software for your 700 Series Computer is on the Pocket PC Web site (<http://www.microsoft.com/mobile/pocketpc>).

### Adding Programs Using ActiveSync

You will need to install the appropriate software for your 700 Series Computer on your desktop computer before installing it on your 700 Series Computer.

- 1 Determine your 700 Series Computer and processor type so that you know which version of the software to install. Tap **Start** → **Settings** → the **System** tab → **About** → the **Version** tab, then make a note of the information in **Processor**.
- 2 Download the program to your desktop computer (or insert the CD or disk that contains the program into your desktop computer). You may see a single \*.XIP, \*.EXE, or \*.ZIP file, a SETUP.EXE file, or several versions of files for different 700 Series Computer types and processors. Be sure to select the program designed for the Pocket PC and your 700 Series Computer processor type.

- 3 Read any installation instructions, Read Me files, or documentation that comes with the program. Many programs provide special installation instructions.
- 4 Connect your 700 Series Computer and desktop computer.
- 5 Double-click the \*.EXE file.
  - If the file is an installer, the installation wizard will begin. Follow the directions on the screen. Once the software has been installed on your desktop computer, the installer will automatically transfer the software to your 700 Series Computer.
  - If the file is not an installer, you will see an error message stating that the program is valid but it is designed for a different type of computer. You will need to move this file to your 700 Series Computer. If you cannot find any installation instructions for the program in the Read Me file or documentation, use ActiveSync Explore to copy the program file to the Program Files folder on your 700 Series Computer. For more information on copying files using ActiveSync, see *ActiveSync Help*.

Once installation is complete, tap **Start** → **Programs**, and then the program icon to switch to it.

### Adding a Program Directly from the Internet

- 1 Determine your 700 Series Computer and processor type so that you know which version of the software to install. Tap **Start** → **Settings** → the **System** tab → **About** → the **Version** tab, then make a note of the information in **Processor**.
- 2 Download the program to your 700 Series Computer straight from the Internet using Pocket Internet Explorer. You may see a single \*.XIP, \*.EXE, or \*.ZIP file, a SETUP.EXE file, or several versions of files for different 700 Series Computer types and processors. Be sure to select the program designed for the Pocket PC and your 700 Series Computer processor type.
- 3 Read any installation instructions, Read Me files, or documentation that comes with the program. Many programs provide installation instructions.
- 4 Tap the file, such as a \*.XIP or \*.EXE file. The installation wizard will begin. Follow the directions on the screen.

### Adding a Program to the Start Menu

Tap **Start** → **Settings** → **Menus** → the **Start Menu** tab, and then the check box for the program. If you do not see the program listed, you can either use File Explorer on the 700 Series Computer to move the program to the **Start Menu** folder, or use ActiveSync on the desktop computer to create a shortcut to the program and place the shortcut in the **Start Menu** folder.

- **Using File Explorer on the 700 Series Computer:**

Tap **Start** → **Programs** → **File Explorer**, and locate the program (tap the folder list, labeled **My Documents** by default, and then **My Device** to see a list of all folders on the 700 Series Computer). Tap and hold the program and tap **Cut** on the pop-up menu. Open the **Start Menu** folder located in the Windows folder, tap and hold a blank area of the window, and tap **Paste** on the pop-up menu. The program will now appear on the **Start** menu. For more information on using File Explorer, see “*Finding and Organizing Information*” on page 25.

- **Using ActiveSync on the desktop computer:**

Use the Explorer in ActiveSync to explore your 700 Series Computer files and locate the program. Right-click the program, and then click **Create Shortcut**. Move the shortcut to the **Start Menu** folder in the Windows folder. The shortcut now appears on the **Start** menu. For more information, see *ActiveSync Help*.

### Removing Programs

- Tap **Start** → **Settings** → the **System** tab → **Remove Programs**.

If the program does not appear in the list of installed programs, use File Explorer on your 700 Series Computer to locate the program, tap and hold the program, and then tap **Delete** on the pop-up menu.



## Microsoft ActiveSync

Visit the following Microsoft Web site for the latest in updates, technical information, and samples:

- <http://www.microsoft.com/mobile/pocketpc/downloads/activesync.asp>

Using Microsoft ActiveSync, you can synchronize the information on your desktop computer with the information on your 700 Series Computer. Synchronization compares the data on your 700 Series Computer with your desktop computer and updates both computers with the most recent information. For example:

- Keep Pocket Outlook data up-to-date by synchronizing your 700 Series Computer with Microsoft Outlook data on your desktop computer.
- Synchronize Microsoft Word and Microsoft Excel files between your 700 Series Computer and desktop computer. Your files are automatically converted to the correct format



**Note:** By default, ActiveSync does not automatically synchronize all types of information. Use ActiveSync options to turn synchronization on and off for specific information types.

With ActiveSync, you can also:

- Back up and restore your 700 Series Computer data.
- Copy (rather than synchronize) files between your 700 Series Computer and desktop computer.
- Control when synchronization occurs by selecting a synchronization mode. For example, you can synchronize continually while connected to your desktop computer or only when you choose the synchronize command.
- Select which information types are synchronized and control how much data is synchronized. For example, you can choose how many weeks of past appointments you want synchronized.

Before you begin synchronization, install ActiveSync on your desktop computer from the Pocket PC Companion CD. For more information on installing ActiveSync, see your Quick Start card. ActiveSync is already installed on your 700 Series Computer.

After installation is complete, the ActiveSync Setup Wizard helps you connect your 700 Series Computer to your desktop computer, set up a partnership so you can synchronize information between your 700 Series Computer and your desktop computer, and customize your synchronization settings. Your first synchronization process will automatically begin when you finish using the wizard.

After your first synchronization, take a look at Calendar, Contacts, and Tasks on your 700 Series Computer. You will notice that information you have stored in Microsoft Outlook on your desktop computer has been copied to your 700 Series Computer, and you did not have to type a word. Disconnect your 700 Series Computer from your computer and you are ready to go!

Once you have set up ActiveSync and completed the first synchronization process, you can initiate synchronization from your 700 Series Computer. To switch to ActiveSync on your 700 Series Computer, tap **Start** → **ActiveSync**. Note that if you have a wireless LAN card, you can synchronize remotely from your 700 Series Computer.

For information about using ActiveSync on your desktop computer, start ActiveSync on your desktop computer, and then see *ActiveSync Help*.

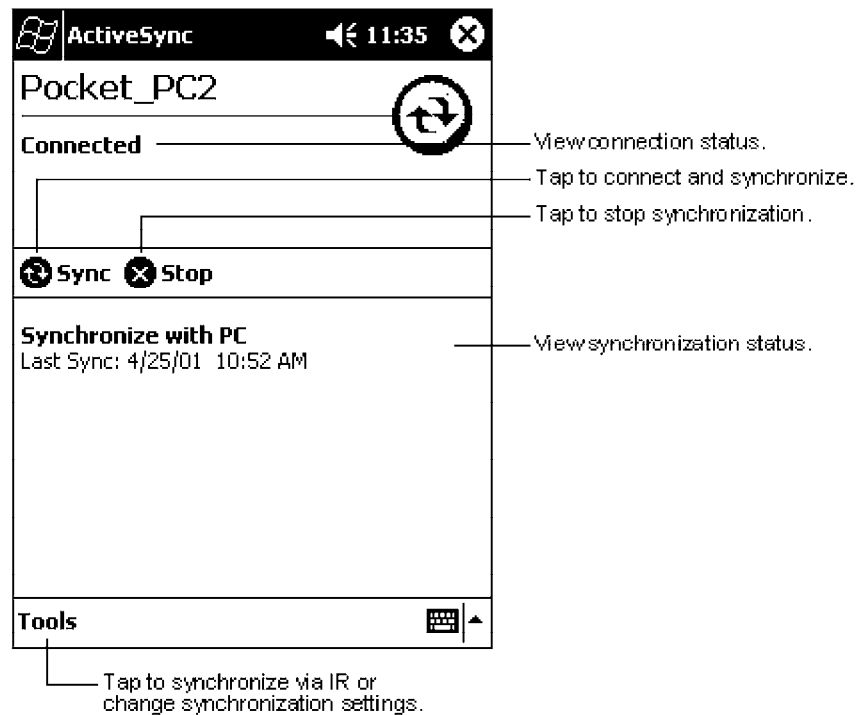

For more information about ActiveSync on your 700 Series Computer, switch to ActiveSync, then tap **Start** → **Help**.

## Microsoft Pocket Outlook



**Note:** The Professional Edition of Microsoft Pocket Outlook does not include a spell checker.

Microsoft Pocket Outlook includes Calendar, Contacts, Tasks, Inbox, and Notes. You can use these programs individually or together. For example, e-mail addresses stored in Contacts can be used to address e-mail messages in Inbox.

Using ActiveSync, you can synchronize information in Microsoft Outlook or Microsoft Exchange on your desktop computer with your 700 Series Computer. You can also synchronize this information directly with a Microsoft Exchange server. Each time you synchronize, ActiveSync compares the changes you made on your 700 Series Computer and desktop computer or server and updates both computers with the latest information. For information on using ActiveSync, see *ActiveSync Help* on the desktop computer.

You can switch to any of these programs by tapping them on the **Start** menu.

### Calendar: Scheduling Appointments and Meetings

Use Calendar to schedule appointments, including meetings and other events. You can check your appointments in one of several views (Agenda, Day, Week, Month, and Year) and easily switch views by using the **View** menu.

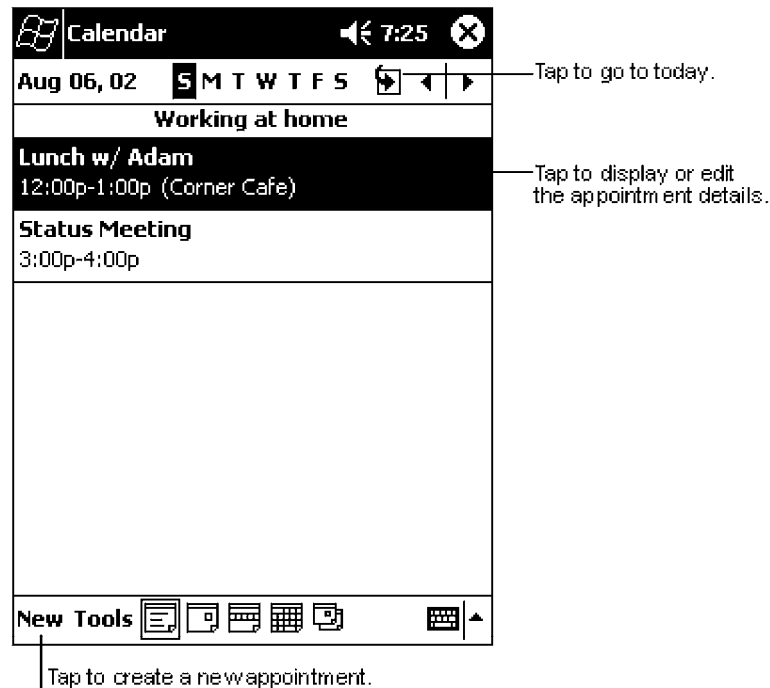



**Note:** You can customize the Calendar display, such as changing the first day of the week, by tapping **Options** on the **Tools** menu.

### Creating an Appointment

- 1 If you are in **Day** or **Week** view, tap the desired date and time for the appointment.
- 2 Tap **New**.
- 3 Using the input panel, enter a description and a location. Tap first to select the field.
- 4 If needed, tap the date and time to change them.
- 5 Enter other desired information. You will need to hide the input panel to see all available fields.
- 6 To add notes, tap the **Notes** tab. You can enter text, draw, or create a recording. For more information on creating notes, see “*Notes: Capturing Thoughts and Ideas*” on page 40.
- 7 When finished, tap **OK** to return to the calendar.

Tap to return to the calendar (the appointment is saved automatically).

Tap to choose from predefined text.

Tap to choose from previously entered locations.

Tap to select a time.

Tap to select a date.

Notes is a good place for maps and directions.

The screenshot shows the 'Calendar' application with a new appointment form. The form includes fields for Subject, Location, Start (8/6/02 12:00 PM), End (8/6/02 1:00 PM), Type (Normal), Occurs (Once), Reminder (Remind me 15 minute(s)), and Categories (No categories...). Below these fields are tabs for 'Appointment' and 'Notes'. At the bottom is a full QWERTY keyboard with function keys like Tab, Shift, and Ctrl.



**Note:** If you select **Remind me** in an appointment, your 700 Series Computer will remind you according to the options set in **Start** → **Settings** → the **Personal** tab → **Sounds & Reminders**.

## Using the Summary Screen

When you tap an appointment in Calendar, a summary screen is displayed. To change the appointment, tap **Edit**.

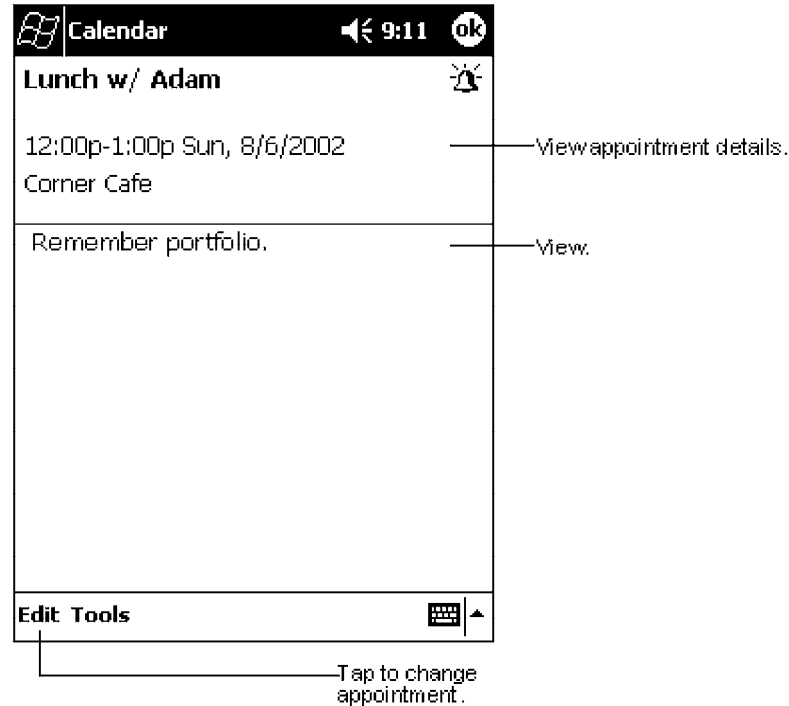

## Creating Meeting Requests

You can use Calendar to set up meetings with users of Outlook or Pocket Outlook. The meeting request will be created automatically and sent either when you synchronize Inbox or when you connect to your e-mail server. Indicate how you want meeting requests sent by tapping **Tools** → **Options**. If you send and receive e-mail messages through ActiveSync, select **ActiveSync**.

## Scheduling a Meeting

- 1 Create an appointment.
- 2 In the appointment details, hide the input panel, and then tap **Attendees**.
- 3 From the list of e-mail addresses you have entered in Contacts, select the meeting attendees.

The meeting notice is created automatically and placed in the Outbox folder.

For more information on sending and receiving meeting requests, see Calendar Help and Inbox Help on the 700 Series Computer.

## Contacts: Tracking Friends and Colleagues

Contacts maintains a list of your friends and colleagues so that you can easily find the information you are looking for, whether you are at home or on the road. Using the 700 Series Computer infrared (IR) port, you can quickly share Contacts information with other 700 Series Computer users.

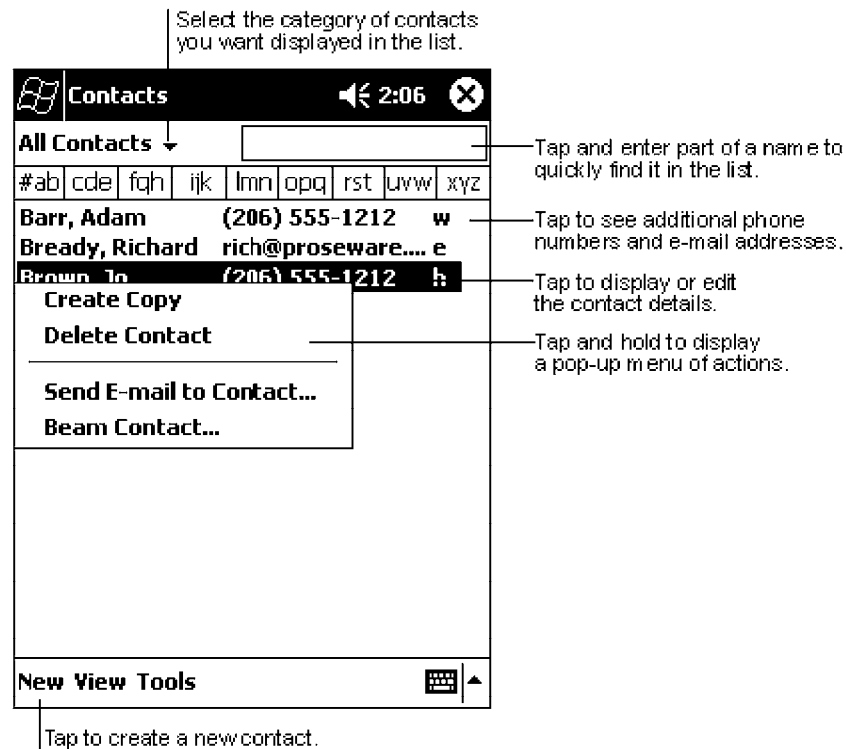

**Note:** To change the way information is displayed in the list, tap **Tools** → **Options**.

### Creating a Contact

- 1 Tap **New**.
- 2 Using the input panel, enter a name and other contact information. You will need to scroll down to see all available fields.
- 3 To assign the contact to a category, scroll to and tap **Categories** and select a category from the list. In the contact list, you can display contacts by category.
- 4 To add notes, tap the **Notes** tab. You can enter text, draw, or create a recording. For more information on creating notes, see “*Notes: Capturing Thoughts and Ideas*” on page 40.

5 When finished, tap **OK** to return to the contact list.

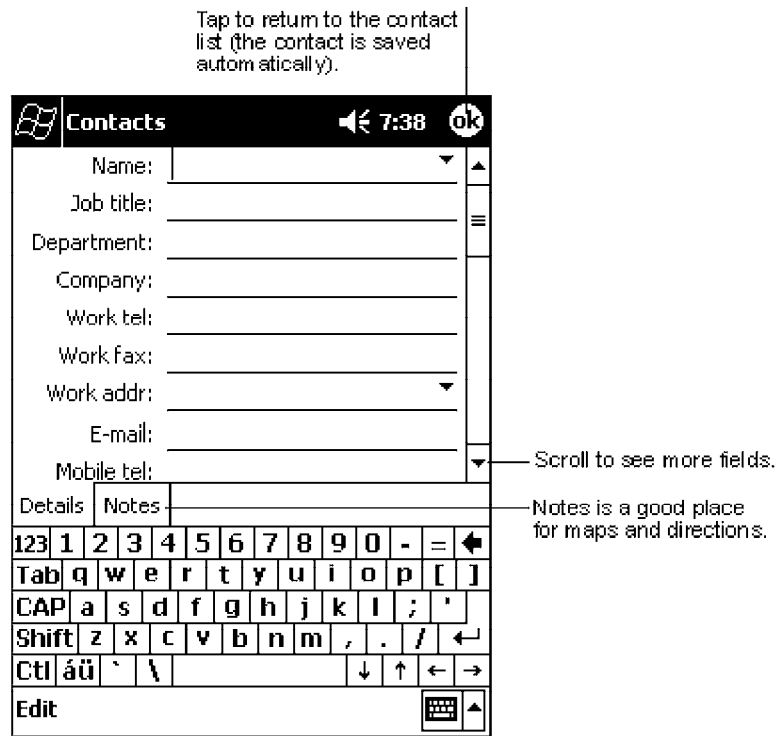

### Finding a Contact

There are four ways to find a contact:

- In the contact list, enter a contact name in the box under the navigation bar. To show all contacts again, clear text from the box or tap the button to the right of the box.
- In the contact list, tap the category list (labeled **All Contacts** by default) and select the type of contact that you want displayed. To show all contacts again, select **All Contacts**. To view a contact not assigned to a category, select **None**.
- To view the names of companies your contacts work for, in the contact list, tap **View** → **By Company**. The number of contacts that work for that company will be displayed to the right of the company name.
- Tap **Start** → **Find**, enter the contact name, select **Contacts** for the type, and then tap **Go**.

### Using the Summary Screen

When you tap a contact in the contact list, a summary screen is displayed. To change the contact information, tap **Edit**.

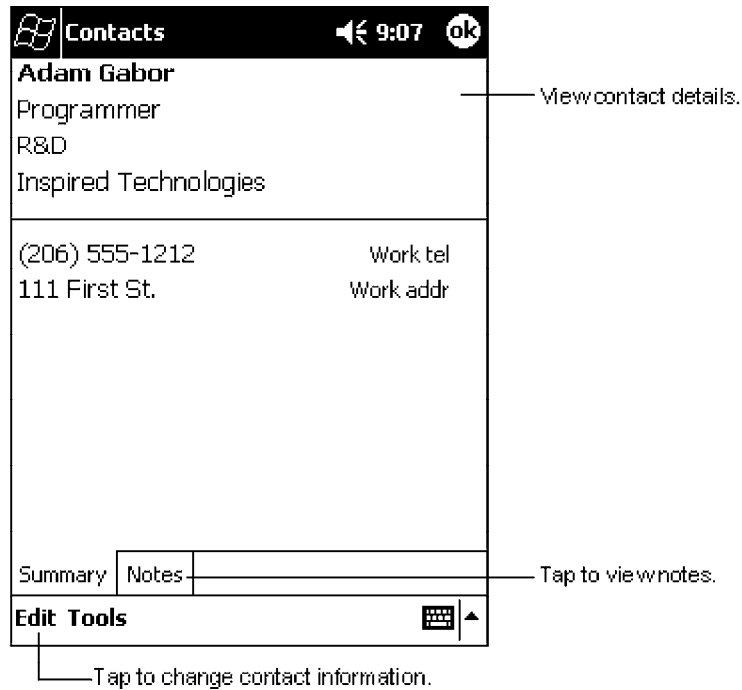



## Tasks: Keeping a To Do List

Use Tasks to keep track of what you have to do.

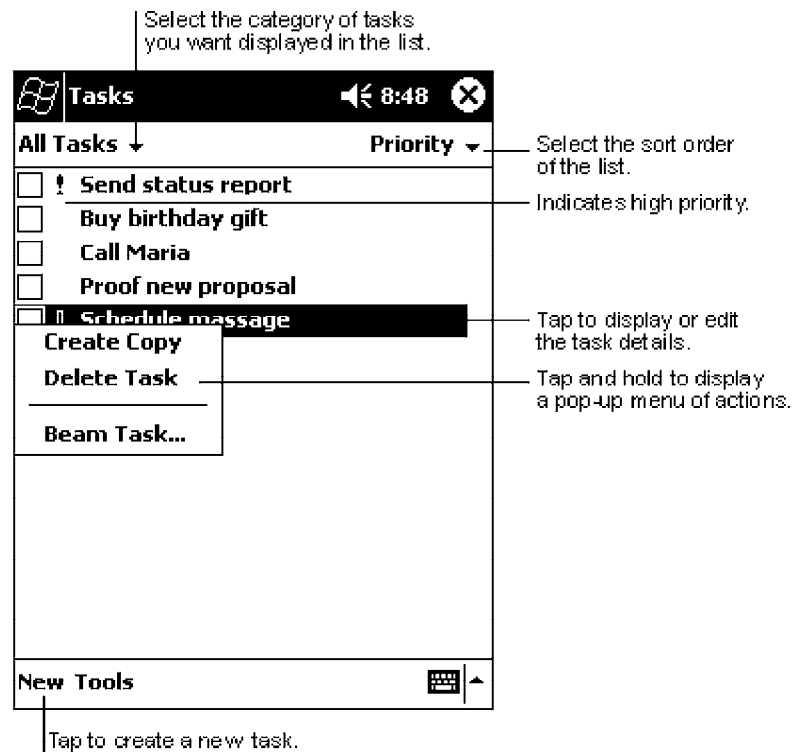

**Note:** To change the way information is displayed in the list, tap **Tools** → **Options**.

## Creating a Task

- 1 Tap **New**.
- 2 Using the input panel, enter a description.
- 3 You can enter a start date and due date or enter other information by first tapping the field. If the input panel is open, you will need to hide it to see all available fields.
- 4 To assign the task to a category, tap **Categories** and select a category from the list. In the task list, you can display tasks by category.
- 5 To add notes, tap the **Notes** tab. You can enter text, draw, or create a recording. For more information on creating notes, see “*Notes: Capturing Thoughts and Ideas*” on page 40.
- 6 When finished, tap **OK** to return to the task list.

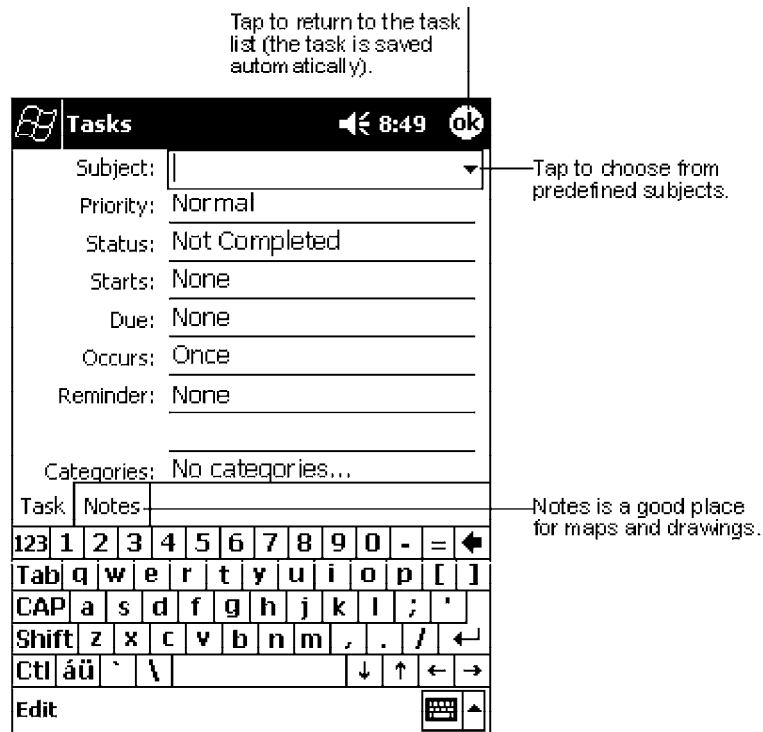

**Note:** To quickly create a task with only a subject, tap **Entry Bar** on the **Tools** menu. Then, tap **Tap here to add a new task** and enter your task information.

## Using the Summary Screen

When you tap a task in the task list, a summary screen is displayed. To change the task, tap **Edit**.

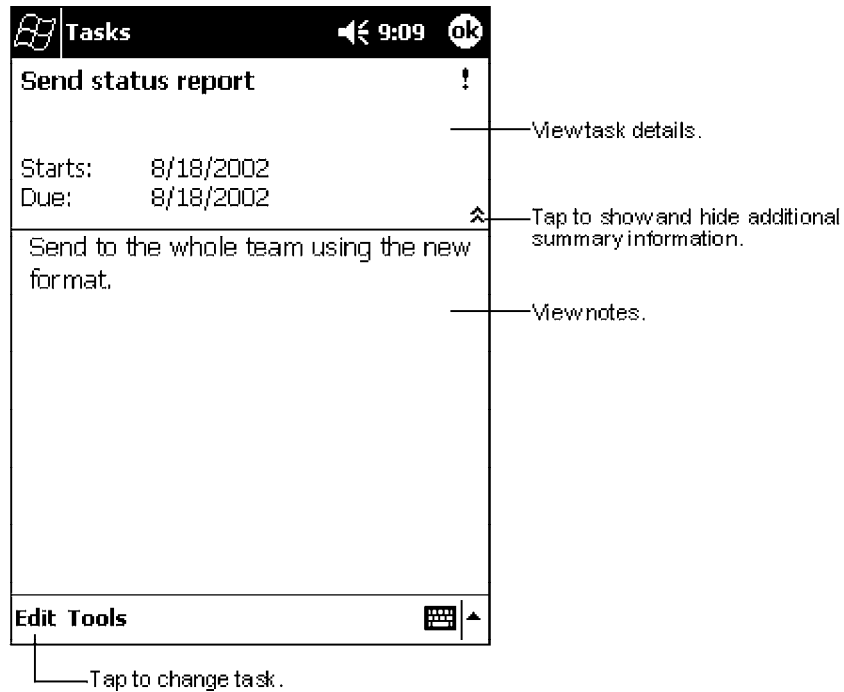

## Notes: Capturing Thoughts and Ideas

Quickly capture thoughts, reminders, ideas, drawings, and phone numbers with Notes. You can create a written note or a recording. You can also include a recording in a note. If a note is open when you create the recording, it will be included in the note as an icon. If the note list is displayed, it will be created as a stand-alone recording.

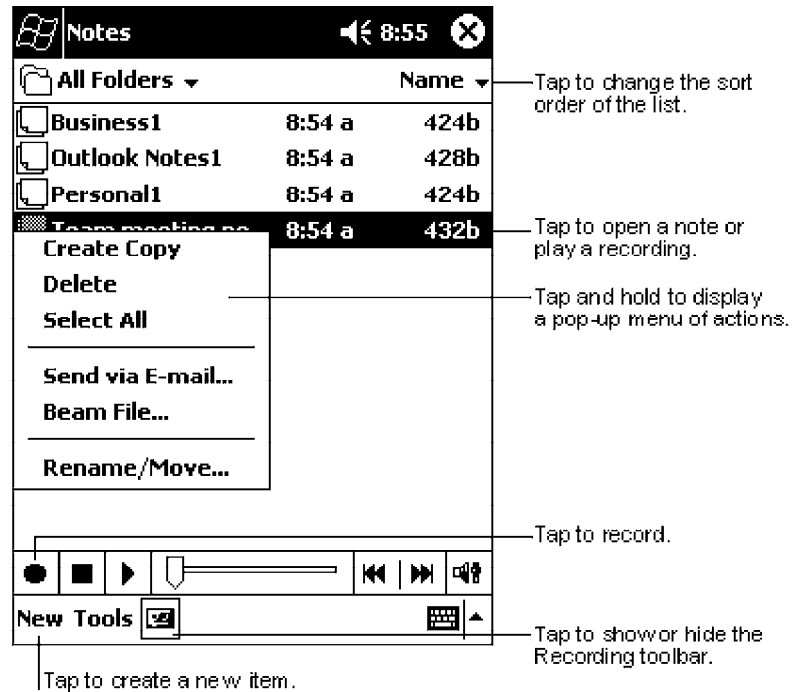

## Creating a Note

- 1 Tap New.
- 2 Create your note by writing, drawing, typing, and recording. For more information about using the input panel, writing and drawing on the screen, and creating recordings, see “Basic Skills” on page 11.

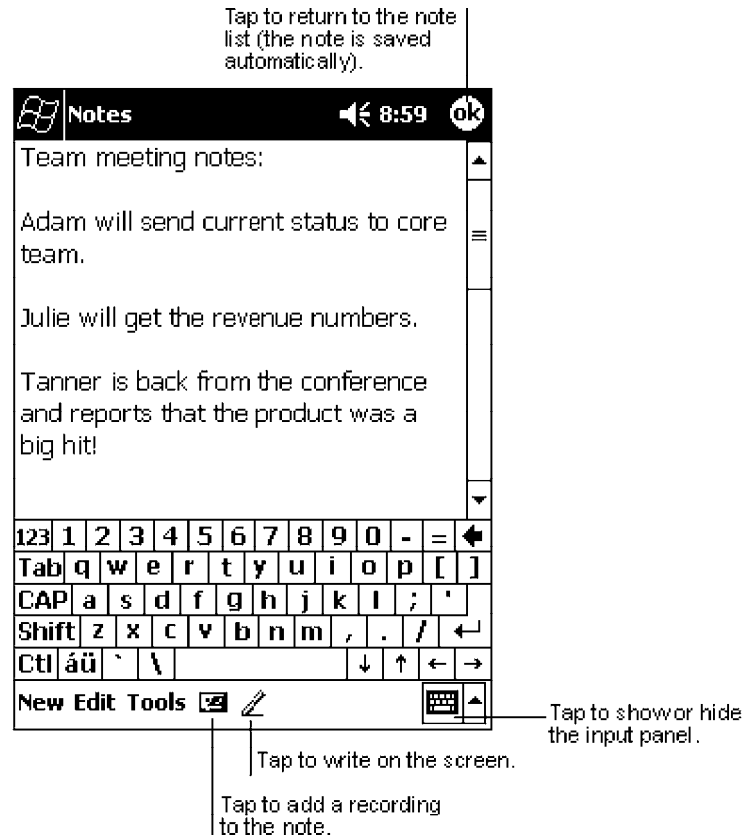

## Inbox: Sending and Receiving E-mail Messages

Use Inbox to send and receive e-mail messages in either of these ways:

- Synchronize e-mail messages with Microsoft Exchange or Microsoft Outlook on your desktop computer.
- Send and receive e-mail messages by connecting directly to an e-mail server through an Internet Service Provider (ISP) or a network.

### Synchronizing E-mail Messages

E-mail messages can be synchronized as part of the general synchronization process. You will need to enable Inbox synchronization in ActiveSync. For information on enabling Inbox synchronization, see *ActiveSync Help* on the desktop computer. During synchronization:

- Messages are copied from the mail folders of Exchange or Outlook on your desktop computer to the ActiveSync folder in Inbox on your 700 Series Computer. By default, you will receive messages from the past three days only, the first 100 lines of each message, and file attachments of less than 100 KB in size.
- E-mail messages in the Outbox folder on your 700 Series Computer are transferred to Exchange or Outlook, and then sent from those programs.
- E-mail messages in subfolders must be selected in ActiveSync on your desktop computer in order to be transferred.

### Connecting Directly to an E-mail Server

In addition to synchronizing e-mail messages with your desktop computer, you can send and receive e-mail messages by connecting to an e-mail server using a modem or network card connected to your 700 Series Computer. You will need to set up a remote connection to a network or an ISP, and a connection to your e-mail server. For more information, see “*Getting Connected*” on page 67.

When you connect to the e-mail server, new messages are downloaded to the 700 Series Computer Inbox folder, messages in the 700 Series Computer Outbox folder are sent, and messages that have been deleted on the e-mail server are removed from the 700 Series Computer Inbox folder.

Messages that you receive directly from an e-mail server are linked to your e-mail server rather than your desktop computer. When you delete a message on your 700 Series Computer, it is also deleted from the e-mail server the next time you connect based on the settings selected in ActiveSync.

You can work online or offline. When working online, you read and respond to messages while connected to the e-mail server. Messages are sent as soon as you tap **Send**, which saves space on your 700 Series Computer.

When working offline, once you have downloaded new message headers or partial messages, you can disconnect from the e-mail server and then decide which messages to download completely. The next time you connect, Inbox downloads the complete messages you have marked for retrieval and sends the messages you have composed.

## Using the Message List

Messages you receive are displayed in the message list. By default, the most recently received messages are displayed first in the list.

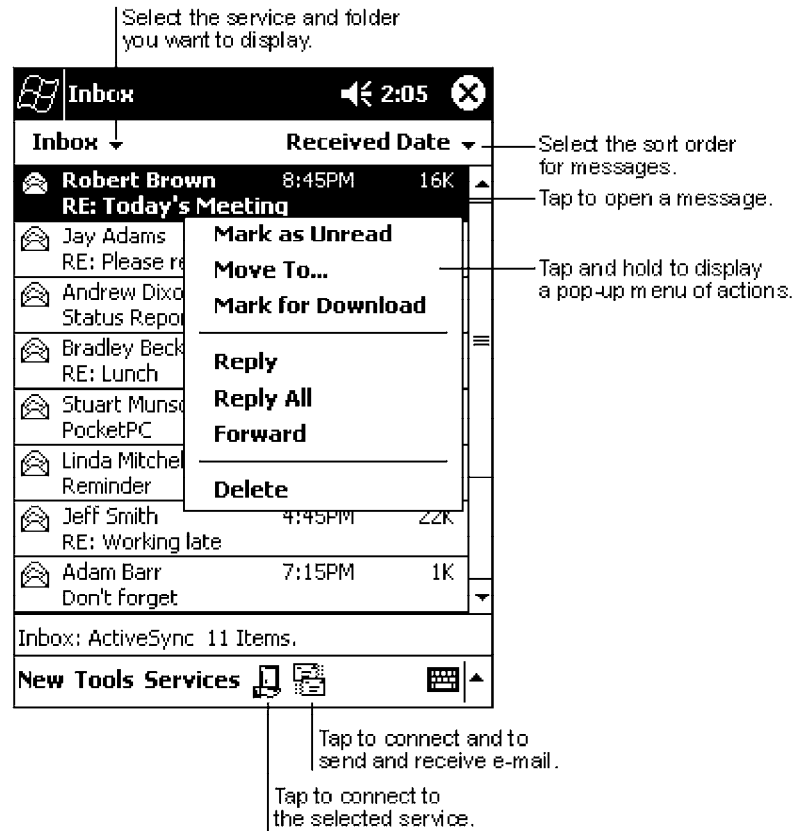

When you receive a message, tap it to open it. Unread messages are displayed in bold.

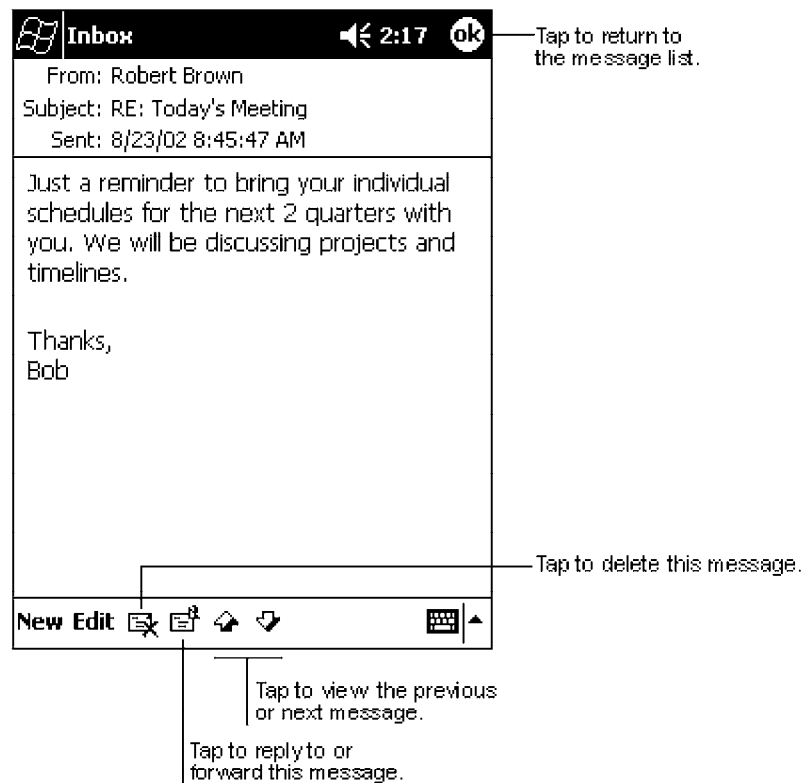

When you connect to your e-mail server or synchronize with your desktop computer, by default, you will receive messages from the last five days only, the first 100 lines of each new message, and file attachments of less than 100 KB in size. The original messages remain on the e-mail server or your desktop computer.

You can mark the messages that you want to retrieve in full during your next synchronization or e-mail server connection. In the message list, tap and hold the message you want to retrieve. On the pop-up menu, tap **Mark for Download**. The icons in the Inbox message list give you visual indications of message status.

You specify your downloading preferences when you set up the service or select your synchronization options. You can change them at any time:

- Change options for Inbox synchronization using ActiveSync options. For more information, see *ActiveSync Help*.
- Change options for direct e-mail server connections in Inbox on your 700 Series Computer. Tap **Tools** → **Options** → the **Service** tab, then tap the service you want to change. Tap and hold the service and select **Delete** to remove a service.



## Composing Messages

To compose a message:

- 1 Tap **New**.
- 2 In the **To** field, enter an e-mail or SMS address of one or more recipients, separating them with a semicolon, or select a name from the contact list by tapping the **Address Book** button. All e-mail addresses entered in the e-mail fields in Contacts appear in the Address Book.
- 3 Compose your message. To enter preset or frequently used messages, tap **My Text** and select a message.
- 4 Tap **Send** when you have finished the message. If you are working offline, the message is moved to the Outbox folder and will be sent the next time you connect.

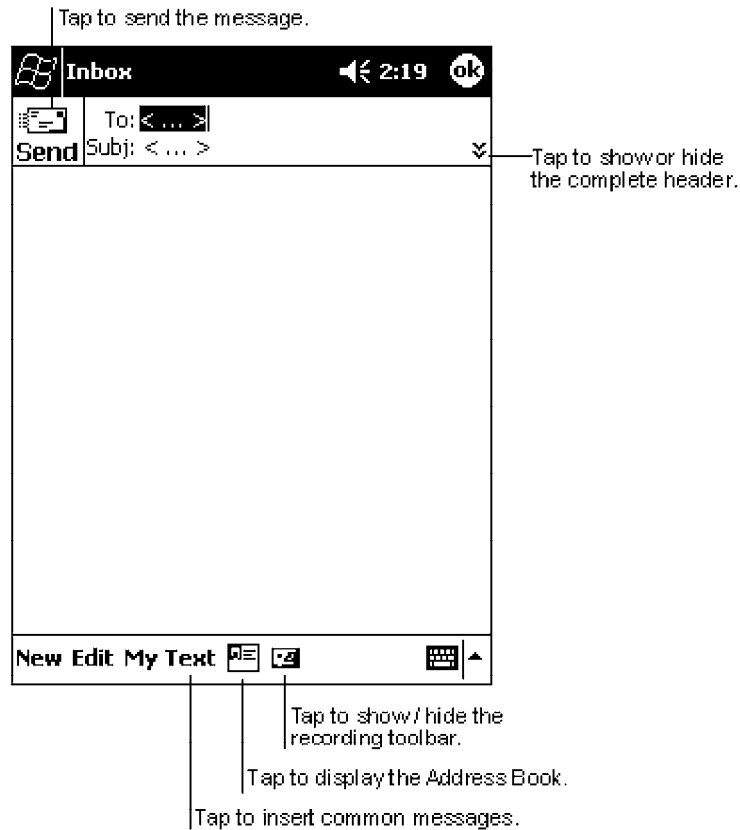

If you are sending an SMS message and want to know if it was received, tap **Edit** → **Options** → **Request SMS text message delivery notification** before sending the message.

### Managing E-mail Messages and Folders

By default, messages are displayed in one of five folders for each service you have created: Inbox, Deleted Items, Drafts, Outbox, and Sent Items. The Deleted Items folder contains messages that have been deleted on the 700 Series Computer. The behavior of the Deleted and Sent Items folders depends on the options you have chosen. In the message list, tap **Tools** → **Options** → the **Message** tab, then select your options.

If you want to organize messages into additional folders, tap **Tools** → **Manage Folders** to create new folders. To move a message to another folder, in the message list, tap and hold the message and then tap **Move to** on the pop-up menu.

### Folder Behavior With a Direct Connection to an E-mail Server

The behavior of the folders you create depends on whether you are using ActiveSync, SMS, POP3, or IMAP4.

- **If you use ActiveSync:**  
E-mail messages in the Inbox folder in Outlook will automatically be synchronized with your 700 Series Computer. You can select to synchronize additional folders by designating them for ActiveSync. The folders you create and the messages you move will then be mirrored on the server. For example, if you move two messages from the Inbox folder to a folder named Family, and you have designated Family for synchronization, the server creates a copy of the Family folder and copies the messages into that folder. You can then read the messages while away from your desktop computer.
- **If you use SMS:**  
Messages are stored in the Inbox folder.
- **If you use POP3:**  
and you move e-mail messages to a folder you created, the link is broken between the messages on the 700 Series Computer and their copies on the mail server. The next time you connect, the mail server will see that the messages are missing from the 700 Series Computer Inbox and delete them from the server. This prevents you from having duplicate copies of a message, but it also means that you will no longer have access to messages that you move to folders created from anywhere except the 700 Series Computer.
- **If you use IMAP4:**  
The folders you create and the e-mail messages you move are mirrored on the server. Therefore, messages are available to you anytime you connect to your mail server, whether it is from your 700 Series Computer or desktop computer. This synchronization of folders occurs whenever you connect to your mail server, create new folders, or rename/delete folders when connected.

## Companion Programs

The companion programs consist of Microsoft Pocket Word, Microsoft Pocket Excel, Windows Media Player for Pocket PC, and Microsoft Reader. To switch to a companion program on your 700 Series Computer, tap **Start** → **Programs**, then tap the program name.

### Pocket Word

Pocket Word works with Microsoft Word on your desktop computer to give you easy access to copies of your documents. You can create new documents on your 700 Series Computer, or you can copy documents from your desktop computer to your 700 Series Computer. Synchronize documents between your desktop computer and your 700 Series Computer so that you have the most up-to-date content in both locations.

#### Creating a Document

Use Pocket Word to create documents, such as letters, meeting minutes, and trip reports. To create a new file, tap **Start** → **Programs** → **Pocket Word** → **New**. A blank document appears. Or, if you have selected a template for new documents in the **Options** dialog box, that template appears with appropriate text and formatting already provided. You can open only one document at a time; when you open a second document, you will be asked to save the first. You can save a document you create or edit in a variety of formats, including Word (.DOC), Pocket Word (.PSW), Rich Text Format (.RTF), and Plain Text (.TXT).

Pocket Word contains a list of the files stored on your 700 Series Computer. Tap a file in the list to open it. To delete, make copies of, and send files, tap and hold a file in the list. Then, select the appropriate action on the pop-up menu.

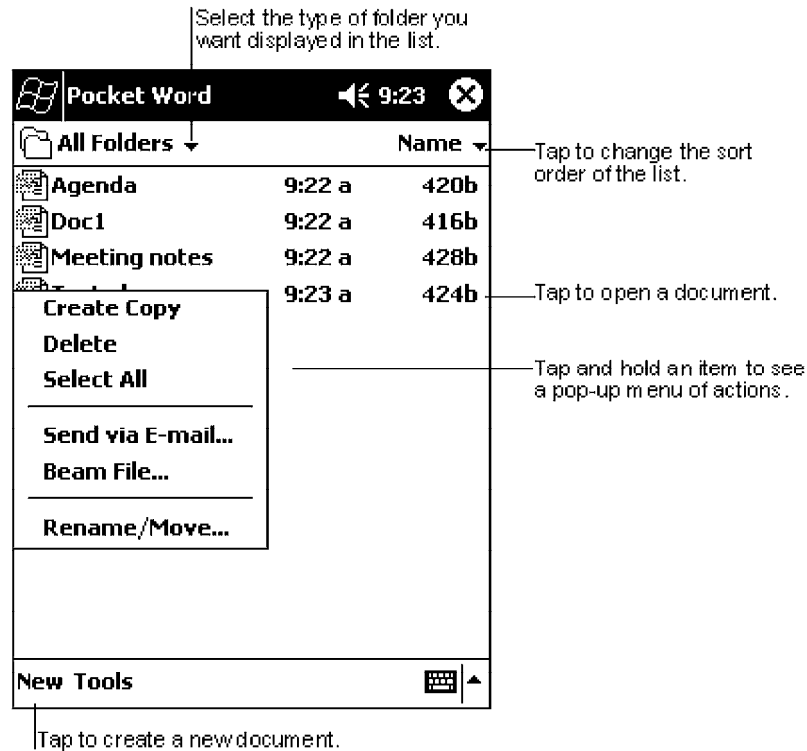

You can enter information in Pocket Word in one of four modes (typing, writing, drawing, and recording), which are displayed on the **View** menu. Each mode has its own toolbar, which you can show and hide by tapping the **Show/Hide Toolbar** button on the command bar.



**Note:** You can change the zoom magnification by tapping **View** → **Zoom**, then select the percentage you want. Select a higher percentage to enter text and a lower one to see more of your document.

If you are opening a Word document created on a desktop computer, select **Wrap to Window** on the **View** menu so that you can see the entire document.

## Typing Mode

Using the input panel, enter typed text into the document. For more information on entering typed text, see “Basic Skills” on page 11.

To format existing text and to edit text, first select the text. You can select text as you do in a Word document, using your stylus instead of the mouse to drag through the text you want to select. You can search a document to find text by tapping **Edit** → **Find/Replace**.



## Writing Mode

In writing mode, use your stylus to write directly on the screen. Ruled lines are displayed as a guide, and the zoom magnification is greater than in typing mode to allow you to write more easily. For more information on writing and selecting writing, see “Basic Skills” on page 11.

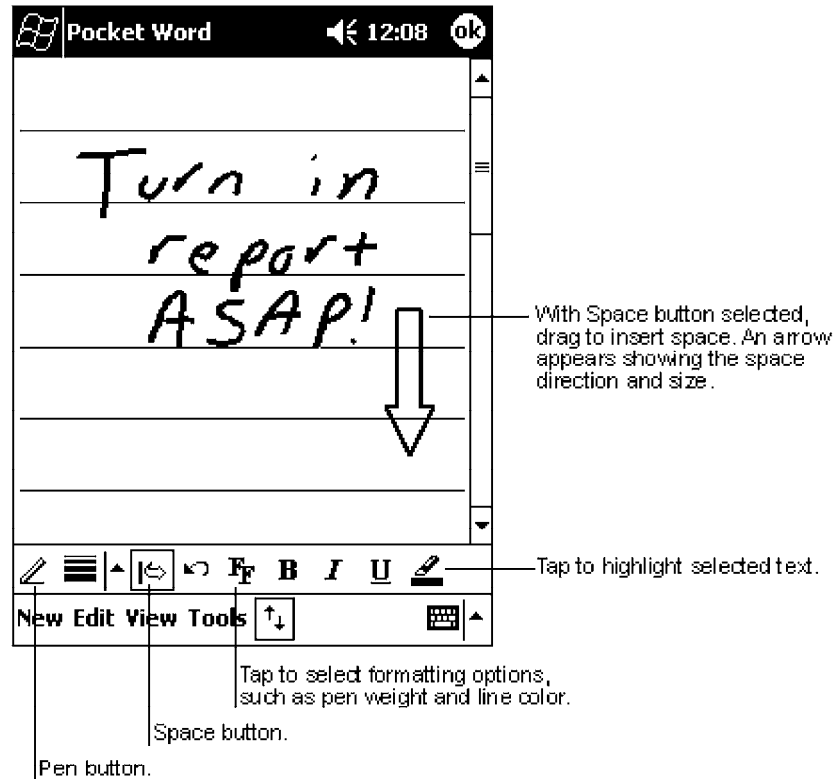

**Note:** If you cross three ruled lines in a single stylus stroke, the writing becomes a drawing, and can be edited and manipulated as described in “Drawing Mode” on the next page.

Written words are converted to graphics (metafiles) when a Pocket Word document is converted to a Word document on your desktop computer.

### Drawing Mode

In drawing mode, use your stylus to draw on the screen. Grid lines appear as a guide. When you lift your stylus off the screen after the first stroke, you will see a drawing box indicating the boundaries of the drawing. Every subsequent stroke within or touching the drawing box becomes part of the drawing. For more information on drawing and selecting drawings, see “Basic Skills” on page 11.

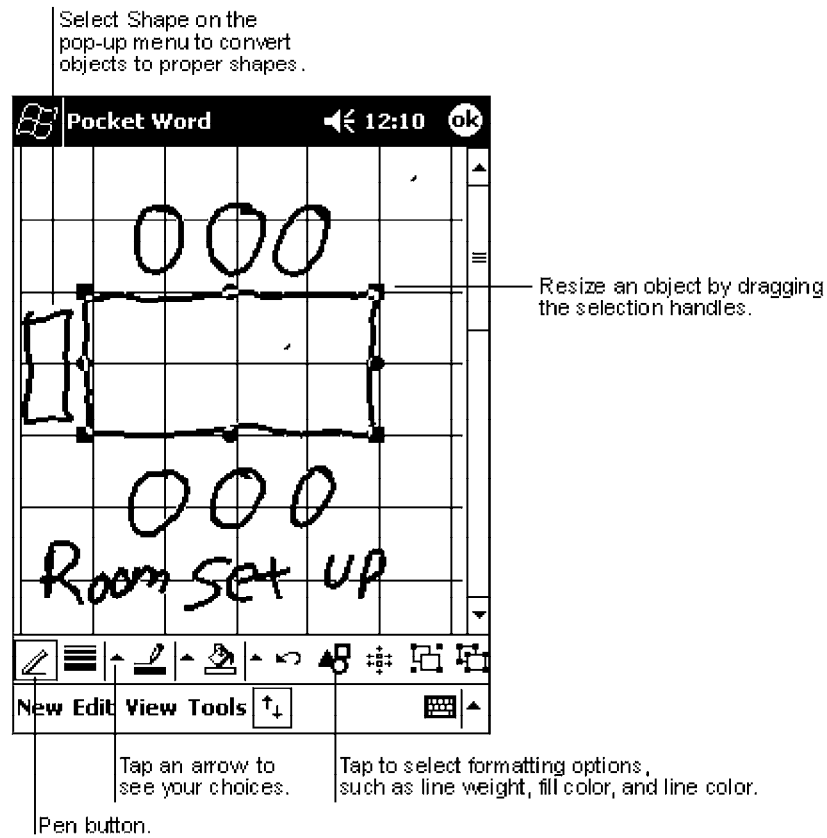

### Recording Mode

In recording mode, embed a recording into your document. Recordings are saved as .WAV files. For more information on recording, see “Basic Skills” on page 11.

For more information on using Pocket Word, tap **Start** → **Help**.

## Pocket Excel

Pocket Excel works with Microsoft Excel on your desktop computer to give you easy access to copies of your workbooks. You can create new workbooks on your 700 Series Computer, or you can copy workbooks from your desktop computer to your 700 Series Computer. Synchronize workbooks between your desktop computer and your 700 Series Computer so that you have the most up-to-date content in both locations.

### Creating a Workbook

Use Pocket Excel to create workbooks, such as expense reports and mileage logs. To create a new file, tap **Start** → **Programs** → **Pocket Excel** → **New**. A blank workbook appears. Or, if you have selected a template for new workbooks in the Options dialog box, that template appears with appropriate text and formatting already provided. You can open only one workbook at a time; when you open a second workbook, you will be asked to save the first. You can save a workbook you create or edit in a variety of formats, including Pocket Excel (.PXL) and Excel (.XLS).

Pocket Excel contains a list of the files stored on your 700 Series Computer. Tap a file in the list to open it. To delete, make copies of, and send files, tap and hold a file in the list. Then select the appropriate action from the pop-up menu.

Pocket Excel provides fundamental spreadsheet tools, such as formulas, functions, sorting, and filtering. To display the toolbar, tap **View** → **Toolbar**.

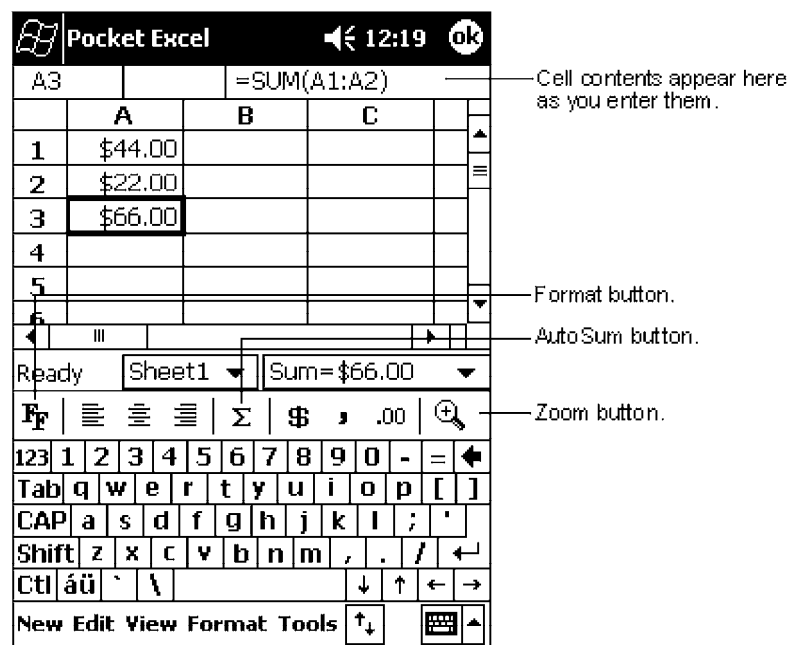





**Note:** If your workbook contains sensitive information, you can protect it with a password. To do so, open the workbook, tap **Edit** → **Password**. Every time you open the workbook, you will need to enter the password, so choose one that is easy for you to remember but hard for others to guess.

### Tips for Working in Pocket Excel

Note the following when working in large worksheets in Pocket Excel:

- View in full-screen mode to see as much of your worksheet as possible. Tap **View** → **Full Screen**. To exit full-screen mode, tap **Restore**.
- Show and hide window elements. Tap **View** and then tap the elements you want to show or hide.
- Freeze panes on a worksheet. First select the cell where you want to freeze panes. Tap **View** → **Freeze Panes**. You might want to freeze the top and leftmost panes in a worksheet to keep row and column labels visible as you scroll through a sheet.
- Split panes to view different areas of a large worksheet. Tap **View** → **Split**. Then drag the split bar to where you want it. To remove the split, tap **View** → **Remove Split**.
- Show and hide rows and columns. To hide a hidden row or column, select a cell in the row or column you want to hide. Then tap **Format**, **Row** or **Column** → **Hide**. To show a hidden row or column, tap **Tools** → **Go To**, and then type a reference that is in the hidden row or column. Then tap **Format** → **Row** or **Column** → **Unhide**.

For more information on using Pocket Excel, tap **Start** → **Help**.

## MSN Messenger



**Note:** MSN Messenger is **only** available on the Premium Edition of Pocket PC 2002.

MSN Messenger on your 700 Series Computer is an instant messaging program that lets you:

- See who is online.
- Send and receive instant messages.
- Have instant message conversations with groups of contacts.

To use MSN Messenger, you must have a Microsoft Passport account or a Microsoft Exchange e-mail account. You must have a Passport to use MSN Messenger Service. If you have a Hotmail or MSN account, you already have a Passport. Once you have obtained either a Microsoft Passport or a Microsoft Exchange account, you are ready to set up your account.

- Sign up for a Microsoft Passport account at <http://www.passport.com>.
- Get a free Microsoft Hotmail e-mail address at <http://www.hotmail.com>.

To switch to MSN Messenger, tap **Start** → **Programs** → **MSN Messenger**.

## Setting Up

Before you can connect, you must enter Passport or Exchange account information. To set up an account and sign in:

- 1 In the **Tools** menu, tap **Options**.
- 2 In the **Accounts** tab, enter your Passport or Exchange account information.
- 3 To sign in, tap the sign-in screen and enter your e-mail address and password.



**Note:** If you already use MSN Messenger on your desktop computer, your contacts will show up on your 700 Series Computer without being added again.

## Working with Contacts

The MSN Messenger window shows all of your messenger contacts at a glance, divided into Online and Not Online categories. From this view, while connected, you can chat, send e-mail, block the contact from chatting with you, or delete contacts from your list using the pop-up menu.

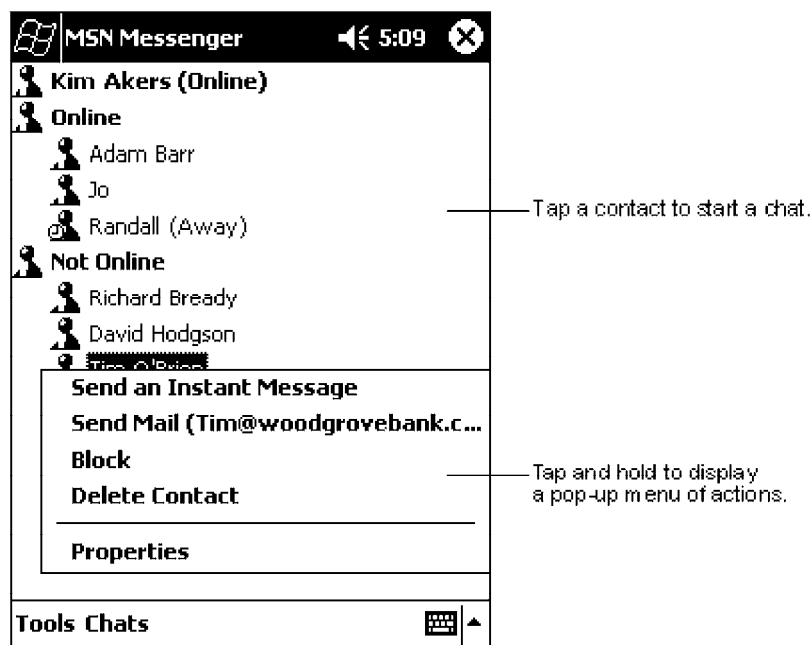

**Note:** To see others online without being seen, in the **Tools** menu, tap **My Status** → **Appear Offline**.

If you block a contact, you will appear offline but will remain on the blocked contact's list. To unblock a contact, tap and hold the contact, then tap **Unblock** on the pop-up menu.

## Chatting with Contacts

Tap a contact name to open a chat window. Enter your message in the text entry area at the bottom of the screen, or tap **My Text** to enter a preset message, and tap **Send**. To invite another contact to a multi-user chat, in the **Tools** menu, tap **Invite** and tap the contact you want to invite.

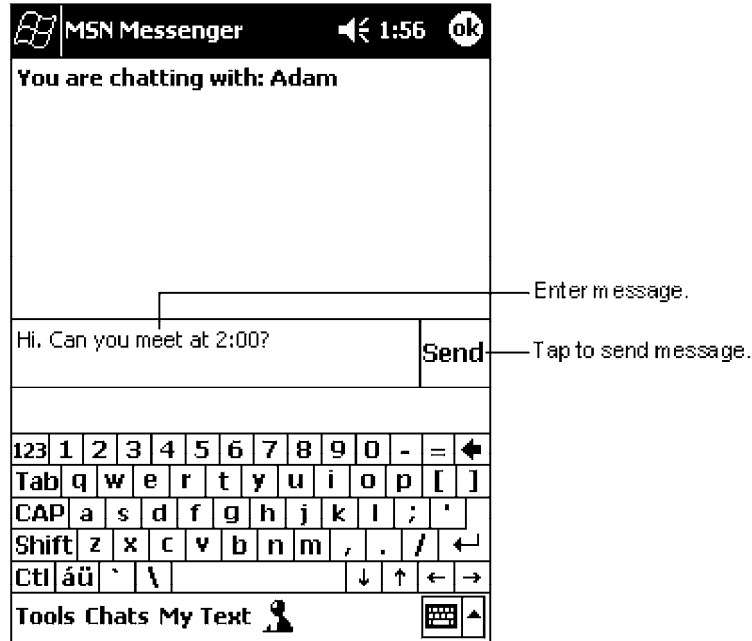

**Note:** To switch back to the main window without closing a chat, tap the **Contacts** button. To revert back to your chat window, tap **Chats** and select the person whom you were chatting with.

To know if the contact you are chatting with is responding, look for the message under the text entry area.

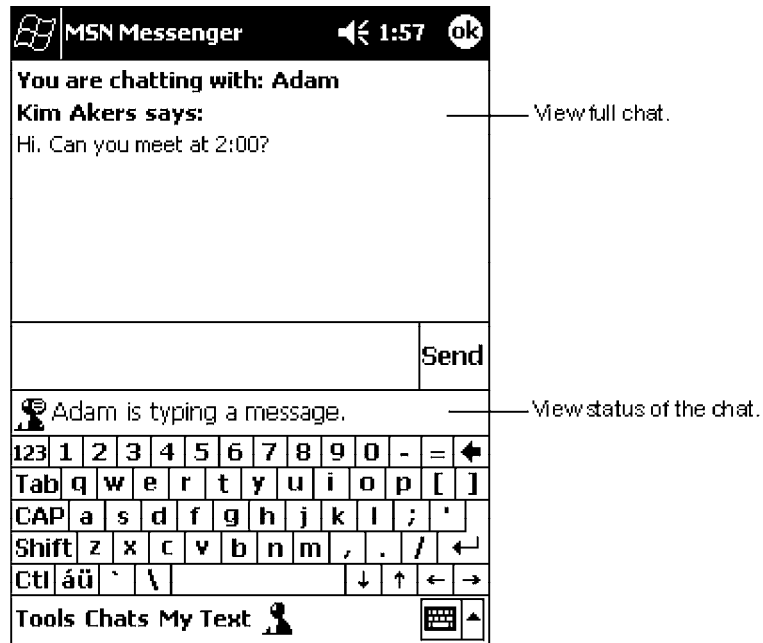

For more information on using MSN Messenger, tap **Start** → **Help**.

## Windows Media Player for Pocket PC

Use Microsoft Windows Media Player for Pocket PC to play digital audio and video files that are stored on your 700 Series Computer or on a network. To switch to Windows Media Player for Pocket PC, tap **Start** → **Programs** → **Windows Media**.

Use Microsoft Windows Media Player on your desktop computer to copy digital audio and video files to your Pocket PC. You can play Windows Media and MP3 files on your Pocket PC.

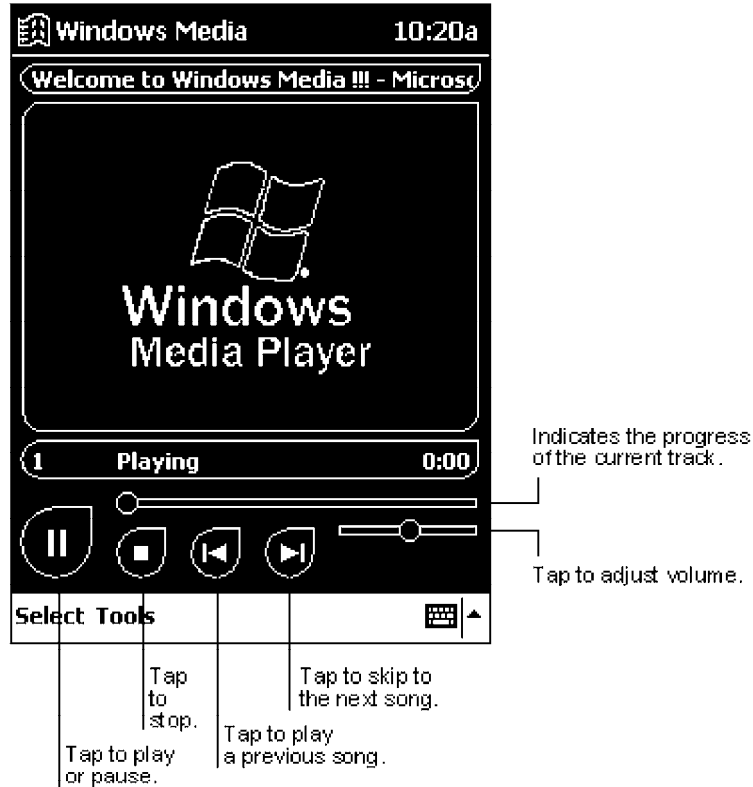

For more information about using Windows Media Player for Pocket PC, tap **Start** → **Help**.

## Microsoft Reader

Use Microsoft Reader to read eBooks on your 700 Series Computer. Download books to your desktop computer from your favorite eBook Web site. Then, use ActiveSync to copy the book files to your activated 700 Series Computer. The books appear in the Reader Library, where you can tap them in the list to open them. Each book consists of a cover page, an optional table of contents, and the pages of the book. You can:

- Page through the book by using the Up/Down control on your 700 Series Computer or by tapping the page number on each page.
- Annotate the book with highlighting, bookmarks, notes, and drawings.
- Search for text and look up definitions for words.

The Guidebook contains all the information you will need to use the software. To open the Guidebook, tap **Help** on the Reader command bar. Or, on a book page, tap and hold on the book title, and then tap **Help** on the pop-up menu. To switch to Microsoft Reader, tap **Start** → **Programs** → **Microsoft Reader**.

### Getting Books on Your 700 Series Computer

You can download book files from the Web. Just visit your favorite eBook retailer and follow the instructions to download the book files.

Sample books and a dictionary are also included in the MSReader folder in the Extras folder on the Pocket PC Companion CD.

Use ActiveSync to download the files from your desktop computer to your activated mobile computer as described in the Read Me file in the MSReader folder.

## Using the Library

The Library is your Reader home page; it displays a list of all books stored on your 700 Series Computer or storage card. To open the Library:

- 1 On the Reader command bar, tap **Library**.
- 2 On a book page, tap the book title, then tap **Library** on the pop-up menu.
- 3 To open a book, tap its title in the Library list.

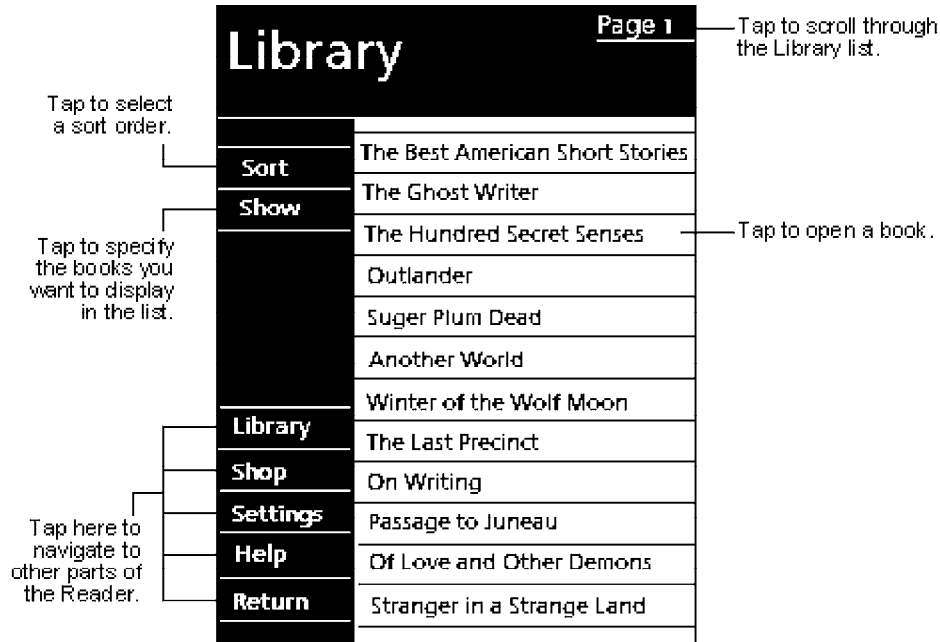

## Reading a Book

Each book consists of a cover page, an optional table of contents, and the pages of the book. Navigation options are listed in the bottom portion of the cover page.

The first time you open a book, you will probably want to go to the first page or to the table of contents, if there is one. Subsequently, whenever you open the book, you will be automatically taken to the last page read.

In addition to the text, each book page includes a page number and book title.

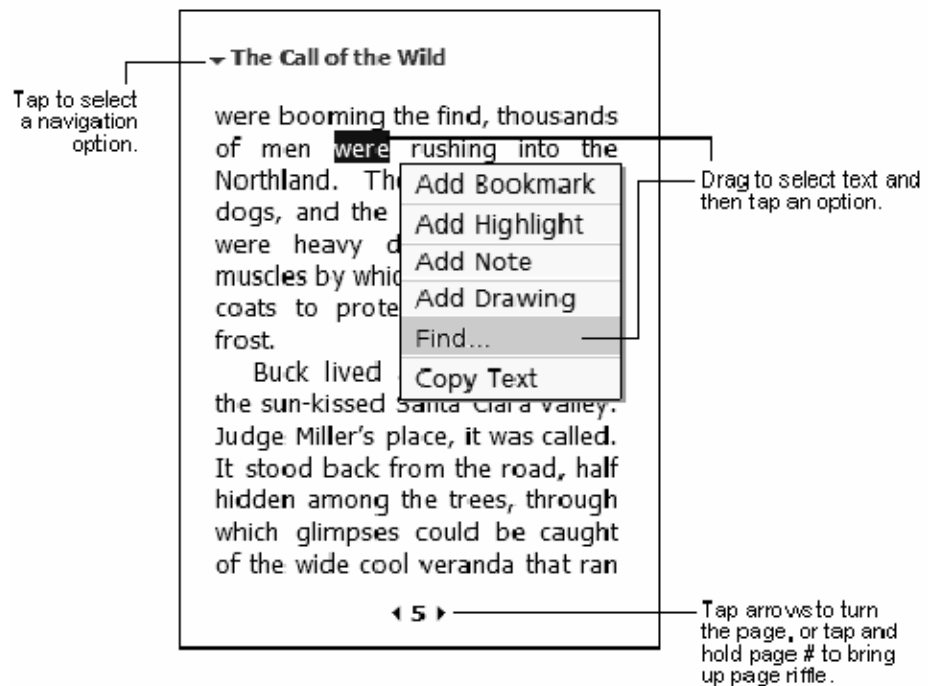

You can also page through a book by using the Up/Down control on your 700 Series Computer.



## Using Reader Features

Reading a book electronically gives you several options not available with paper books. These options are available from any book page.

Select text by dragging across the text on the page. Then, tap an option on the pop-up menu, as described here:

- **Searching for Text**  
Find text in a book by tapping **Find** on the pop-up menu. Enter the word you want to search for, and tap the desired **Find** option. Reader highlights found text on the page. To close **Find**, tap outside the box. To return to your original page, tap the title and then tap **Return** on the pop-up menu.
- **Copying Text**  
You can copy text from books that support this feature into any program that accepts text. On a book page, select the text you want to copy. Then, tap **Copy Text** on the pop-up menu. The text can be pasted into the program of your choice.
- **Adding Bookmarks**  
When you add a bookmark to a book, a color-coded bookmark icon appears in the right margin. You can add multiple bookmarks to a book. Then, from anywhere in the book, tap the bookmark icon to go to the bookmarked page.
- **Highlighting Text**  
When you highlight text, it appears with a colored background.
- **Attaching Notes to Text**  
When you attach a note to text, you enter the text in a notepad that appears on top of the book page. A **Note** icon will display in the left margin. To show or hide the note, tap the icon.
- **Adding Drawings**  
When you add a drawing, a **Drawing** icon appears in the bottom-left corner of the page, and drawing tools appear across the bottom of the page. Draw by dragging your stylus.
- **Annotations Index**  
To see a list of a book's annotations, including bookmarks, highlights, text notes, and drawings, tap **Annotations Index** on the book's cover page. You can tap an entry in the list to go to the annotated page.

## Removing a Book

When you finish reading a book, you can delete it to conserve space on your 700 Series Computer. If a copy of the book is stored on your desktop computer, you can download it again at any time.

To remove a book from your 700 Series Computer, tap and hold the title in the Library list, and then tap **Delete** on the pop-up menu.

## Pocket Internet Explorer



**Note:** The Professional Edition of Pocket Internet Explorer does not support WAP pages.

Use Microsoft Pocket Internet Explorer to view Web or WAP pages in either of these ways:

- During synchronization with your desktop computer, download your favorite links and mobile favorites that are stored in the Mobile Favorites subfolder in Internet Explorer on the desktop computer.
- Connect to an ISP or network and browse the Web. To do this, you will need to create the connection first, as described in “*Getting Connected*” on page 67.

When connected to an ISP or network, you can also download files and programs from the Internet or intranet.

To switch to Pocket Internet Explorer, tap **Start** → **Internet Explorer**.

### The Mobile Favorites Folder

Only items stored in the Mobile Favorites subfolder in the Favorites folder in Internet Explorer on your desktop computer will be synchronized with your 700 Series Computer. This folder was created automatically when you installed ActiveSync.

### Favorite Links

During synchronization, the list of favorite links in the Mobile Favorites folder on your desktop computer is synchronized with Pocket Internet Explorer on your 700 Series Computer. Both computers are updated with changes made to either list each time you synchronize. Unless you mark the favorite link as a mobile favorite, only the link will be downloaded to your 700 Series Computer, and you will need to connect to your ISP or network to view the content. For more information on synchronization, see *ActiveSync Help* on the desktop computer.

### Mobile Favorites

If you are using Microsoft Internet Explorer 5.0 or later on your desktop computer, you can download mobile favorites to your 700 Series Computer. Synchronizing mobile favorites downloads Web content to your 700 Series Computer so that you can view pages while you are disconnected from your ISP and desktop computer.

Use the Internet Explorer plug-in installed with ActiveSync to create mobile favorites quickly. To create a mobile favorite:

- 1 In Internet Explorer on your desktop computer, click **Tools** → **Create Mobile Favorite**.
- 2 To change the link name, enter a new name in the **Name** box.
- 3 Optionally, in **Update**, select a desired update schedule.

- 4 Click **OK**. Internet Explorer downloads the latest version of the page to your desktop computer.
- 5 If you want to download the pages that are linked to the mobile favorite you just created, in Internet Explorer on the desktop computer, right-click the mobile favorite just created and then click **Properties**. In the **Download** tab, specify the number of links deep you want to download. To conserve 700 Series Computer memory, go only one level deep.
- 6 Synchronize your 700 Series Computer and desktop computer. Mobile favorites that are stored in the Mobile Favorites folder in Internet Explorer are downloaded to your 700 Series Computer.



**Note:** If you did not specify an update schedule in step 3 above, you will need to manually download content to keep the information updated on your desktop computer and 700 Series Computer. Before synchronizing with your 700 Series Computer, in Internet Explorer on your desktop computer, click **Tools** → **Synchronize**. You will see the last time content was downloaded to the desktop computer, and you can manually download content if needed.

You can add a button to the Internet Explorer toolbar for creating mobile favorites. In Internet Explorer on your desktop computer, click **View** → **Toolbars** → **Customize**.

Mobile favorites take up storage memory on your 700 Series Computer. To minimize the amount of memory used:

- In the settings for the Favorites information, type in ActiveSync options, turn off pictures and sounds, or stop some mobile favorites from being downloaded to the 700 Series Computer. For more information, see *ActiveSync Help*.
- Limit the number of downloaded linked pages. In Internet Explorer on the desktop computer, right-click the mobile favorite you want to change and then **Properties**. In the **Download** tab, specify “0” or “1” for the number of linked pages you want to download.

## Using AvantGo Channels

AvantGo is a free interactive service that gives you access to personalized content and thousands of popular Web sites. You subscribe to AvantGo channels directly from your 700 Series Computer. Then, you synchronize your 700 Series Computer and desktop computer, or connect to the Internet to download the content. For more information, visit the AvantGo Web site. To sign up for AvantGo:

- 1 In ActiveSync options on the desktop computer, turn on synchronization for the AvantGo information type.
- 2 In Pocket Internet Explorer on your 700 Series Computer, tap the **Favorites** button to display your list of favorites.
- 3 Tap the **AvantGo Channels** link.
- 4 Tap the **Activate** button.
- 5 Follow the directions on the screen. You will need to synchronize your 700 Series Computer with your desktop computer and then tap the **My Channels** button to complete the AvantGo setup.

When synchronization is complete, tap the **AvantGo Channels** link in your list of favorites to see a few of the most popular channels. To add or remove channels, tap the **Add** or **Remove** link.

## Using Pocket Internet Explorer

You can use Pocket Internet Explorer to browse mobile favorites and channels that have been downloaded to your 700 Series Computer without connecting to the Internet. You can also connect to the Internet through an ISP or a network connection and browse the Web.



## Viewing Mobile Favorites and Channels

- 1 Tap the Favorites button to display your list of favorites.
- 2 Tap the page you want to view.

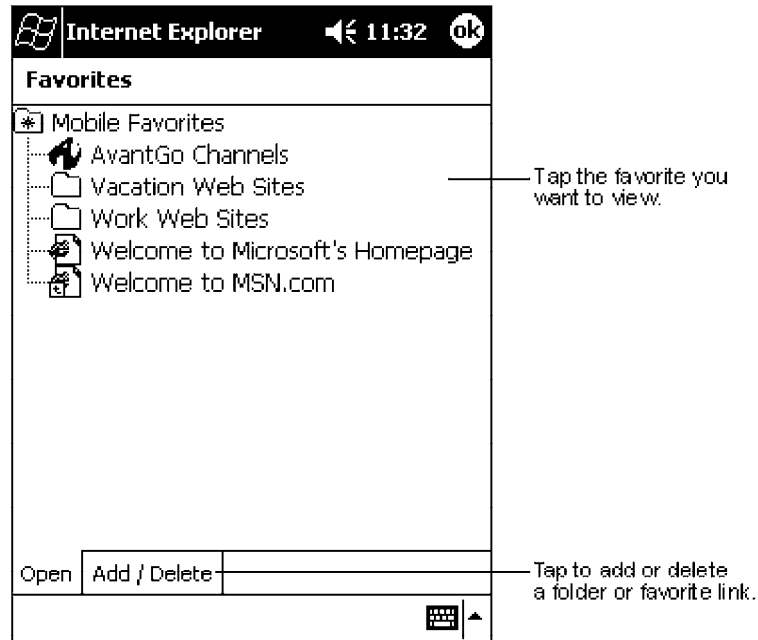

You will see the page that was downloaded the last time you synchronized with your desktop computer. If the page is not on your 700 Series Computer, the favorite will be dimmed. You will need to synchronize with your desktop computer again to download the page to your 700 Series Computer, or connect to the Internet to view the page.

## Browsing the Internet

- 1 Set up a connection to your ISP or corporate network using **Connections**, as described in “*Getting Connected*” on page 67.
- 2 To connect and start browsing, do one of the following:
  - Tap the **Favorites** button, and then tap the favorite you want to view.
  - Tap **View** → **Address Bar**. In the address bar that appears at the top of the screen, enter the Web address you want to visit and then tap **Go**. Tap the arrow to choose from previously entered addresses.



**Note:** To add a favorite link while using the 700 Series Computer, go to the page you want to add, tap and hold on the page, and tap **Add to Favorites**.

## Getting Connected

You can use your 700 Series Computer to exchange information with other 700 Series Computers as well as your desktop computer, a network, or the Internet. You have the following connection options:

- Use the infrared (IR) port on your 700 Series Computer to send and receive files between two 700 Series Computers. If this is the method you want to use, see “*Transferring Items Using Infrared*” below.
- Connect to your ISP. Once connected, you can send and receive e-mail messages by using Inbox and view Web or WAP pages by using Pocket Internet Explorer. The communication software for creating an ISP connection is already installed on your 700 Series Computer. Your service provider will provide software needed to install other services, such as paging and fax services. If this is the method you want to use, see “*Connecting to an Internet Service Provider*” on page 68.
- Connect to the network at your company or organization where you work. Once connected, you can send and receive e-mail messages by using Inbox, view Web or WAP pages by using Pocket Internet Explorer, and synchronize with your desktop computer. If this is the method you want to use, see “*Connecting to Work*” on page 70.
- Connect to your desktop computer to synchronize remotely. Once connected, you can synchronize information such as your Pocket Outlook information. If this is the method you want to use, see *ActiveSync Help* on your desktop computer or Connections Help on the 700 Series Computer.

## Transferring Items Using Infrared

Using infrared (IR), you can send and receive information, such as contacts and appointments, between two 700 Series Computers.

### Sending Information

- 1 Switch to the program where you created the item you want to send and locate the item in the list.
- 2 Align the IR ports so that they are unobstructed and within a close range.
- 3 Tap and hold the item, and tap **Beam Item** on the pop-up menu.



**Note:** You can also send items, but not folders, from File Explorer. Tap and hold the item you want to send, and then tap **Beam File** on the pop-up menu.

### Receiving Information

- 1 Align the IR ports so that they are unobstructed and within a close range.
- 2 Have the owner of the other 700 Series Computer send the information to you. Your 700 Series Computer will automatically receive it.

## Connecting to an Internet Service Provider

You can connect to your ISP, and use the connection to send and receive e-mail messages and view Web or WAP pages. You can connect to your ISP in one of two ways:

- Create a modem connection. If this is the method you want to use, see “*Creating a Modem Connection to an ISP*” below.
- Use an Ethernet card and a net tap to connect to the network. If this is the method you want to use, see “*Creating an Ethernet Connection to an ISP*” on page 69.

### Creating a Modem Connection to an ISP

- 1 Obtain the following information from your ISP. Some ISPs require information in front of the user name, such as MSN/username.
  - ISP dial-up access telephone number
  - User name
  - Password
  - TCP/IP settings
- 2 If your 700 Series Computer does not have a built-in modem, install a modem card, or use or use a NULL modem cable and appropriate adapters to connect an external modem to your 700 Series Computer through the serial port.
- 3 Tap **Start** → **Settings** → the **Connections** tab → **Connections**. Under The Internet settings, select **Internet Settings** → **Modify**.
- 4 In the **Modem** tab, tap **New**.
- 5 Enter a name for the connection, such as “ISP Connection.”
- 6 In **Select a modem list**, select your modem type. If your modem type does not appear, try reinserting the modem card. If you are using an external modem that is connected to your 700 Series Computer with a cable, select “Hayes Compatible on COM1.”
- 7 You should not need to change any settings in **Advanced**. Most ISPs now use a dynamically-assigned address. If the ISP you are connecting to does not use a dynamically-assigned address, tap **Advanced** → the **TCP/IP** tab, then enter the address. When finished, tap **OK** → **Next**.
- 8 Enter the access phone number, and tap **Next**.
- 9 Select other desired options, and tap **Finish**.
- 10 In the **Dialing Locations** tab, specify your current location and phone type (most phone lines are tone). These settings will apply to all connections you create.



To start the connection, simply start using one of the following programs. Your 700 Series Computer will automatically begin connecting. Once connected, you can:

- Send and receive e-mail messages by using Inbox. Before you can use Inbox, you need to provide the information it needs to communicate with the e-mail server. For specific instructions, see “*Connecting Directly to an E-mail Server*” on page 72.
- Visit Web and WAP pages by using Pocket Internet Explorer. For more information, see “*Pocket Internet Explorer*” on page 62.
- Send and receive instant messages with MSN Messenger. For more information, see “*MSN Messenger*” on page 53.

### Creating an Ethernet Connection to an ISP

- 1 You do not need to create a new connection on your 700 Series Computer. Instead, you must purchase a dock to enable on-board Ethernet or purchase a CompactFlash Ethernet card that is compatible with your 700 Series Computer.
- 2 Obtain the following information from your ISP:
  - User name
  - Password
  - Domain name
- 3 Insert the Ethernet card into your 700 Series Computer. For instructions on inserting and using the Ethernet card, see the owner’s manual.



*If using an on-board Ethernet*, place your 700 Series Computer in a dock, tap **Start** → **Today**, then look in the System Tray for the Ethernet icon (shown left). If not there, then tap the antenna icon for the NDISTRAY pop-up menu and select **Built-in Ethernet** from the menu.

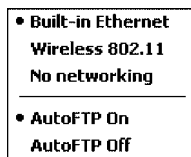

- 4 The first time you insert the card, **Network Settings** will appear automatically so that you can configure the Ethernet card. Most networks use DHCP, so you should not have to change these settings unless your network administrator instructs you to do so. Tap **OK**. (If it does not appear or to change settings later, tap **Start** → **Settings** → the **Connections** tab → **Network**, tap the adapter you want to change, and then tap **Properties**.)



- *If using an on-board Ethernet*, then select **Start** → **Settings** → the **Connections** tab → **Network Adapters**. Select “NE2000 Compatible Ethernet Driver” from the list of adapters installed, then tap **Properties** to configure the Ethernet driver.

- 5 Connect the Ethernet card or dock to the network by using a network cable. For information, see your owner's manual.
- 6 Tap **Start** → **Settings** → the **Connections** tab → **Connections**. From the **My network card connects to** list, select "Internet."

To start the connection, simply start using one of the programs listed in the preceding section. Once connected, you can perform the same activities as listed in the preceding section.

## Connecting to Work

If you have access to a network at work, you can send e-mail messages, view intranet pages, synchronize your 700 Series Computer, and possibly access the Internet. You can connect to work in one of two ways:

- Create a modem connection by using a RAS (Remote Access Server) account. Before you can create this modem connection, your network administrator will need to set up a RAS account for you. If this is the method you want to use, see "*Creating a Modem Connection to Work*" below. Your network administrator may also give you VPN settings.
- Use an Ethernet card and a net tap to connect to the network. If this is the method you want to use, see "*Creating an Ethernet Connection to Work*" on page 71.

### Creating a Modem Connection to Work

- 1 Get the following information from your network administrator:
  - Dial-up access telephone number
  - User name
  - Password
  - Domain name
  - TCP/IP settings
- 2 If your 700 Series Computer does not have a built-in modem, install a modem card.
- 3 Tap **Start** → **Settings** → the **Connections** tab → **Connections**. Under The Internet settings, select **Internet Settings** and tap **Modify**.
- 4 In the **Modem** tab, tap **New**.
- 5 Enter a name for the connection, such as "Company Connection."
- 6 In the **Select a modem list**, select your modem type. If your modem type does not appear, try reinserting the modem card. If you are using an external modem that is connected to your 700 Series Computer with a cable, select "Hayes Compatible on COM1."
- 7 You should not need to change any settings in **Advanced**. Most servers now use a dynamically-assigned address. If the server you are connecting to does not use a dynamically-assigned address, tap **Advanced** → the **TCP/IP** tab and then enter the address. When finished, tap **OK** → **Next**.

- 8 Enter the access phone number, and tap **Next**.
- 9 Select other desired options, and tap **Finish**.
- 10 In the **Dialing Locations** tab, specify your current location and phone type (most phone lines are tone). These settings will apply to all connections you create.

To start the connection, start using one of the following programs. Your 700 Series Computer will automatically begin connecting. Once connected, you can:

- Send and receive e-mail messages by using Inbox. Before you can use Inbox, you need to provide the information it needs to communicate with the e-mail server. For specific instructions, see “*Connecting Directly to an E-mail Server*” on page 72.
- Visit Internet or intranet Web or WAP pages via Pocket Internet Explorer.
- Send and receive instant messages with MSN Messenger. For more information, see “*MSN Messenger*” on page 53.
- Synchronize. For more information, see *ActiveSync Help* on the desktop computer.

### Creating an Ethernet Connection to Work

- 1 You do not need to create a new connection on your 700 Series Computer. Instead, you must purchase a dock to enable on-board Ethernet or purchase a CompactFlash Ethernet card that is compatible with your 700 Series Computer.
- 2 Obtain the following information from your ISP:
  - User name
  - Password
  - Domain name
- 3 Insert the Ethernet card into your 700 Series Computer. For instructions on inserting and using the Ethernet card, see the owner’s manual.
  - *If using an on-board Ethernet*, place your 700 Series Computer in a dock, tap **Start** → **Today**, then look in the System Tray for the Ethernet icon (*shown left*). If not there, then tap the antenna icon for the NDISTRAY pop-up menu and select **Built-in Ethernet** from the menu.

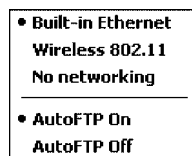

- 4 The first time you insert the card, **Network Settings** will appear automatically so that you can configure the Ethernet card. Most networks use DHCP, so you should not have to change these settings unless your network administrator instructs you to do so. Tap **OK**. (If it does not appear or to change settings later, tap **Start** → **Settings** → the **Connections** tab → **Network**, tap the adapter you want to change, and then tap **Properties**.)



- *If using an on-board Ethernet*, then select **Start** → **Settings** → the **Connections** tab → **Network Adapters**. Select “NE2000 Compatible Ethernet Driver” from the list of adapters installed, then tap **Properties** to configure the Ethernet driver.
- 5 Connect the Ethernet card or dock to the network by using a network cable. For information, see your owner’s manual.
  - 6 To synchronize your 700 Series Computer, tap **Start** → **ActiveSync**. In the **Tools** menu, tap **Options**. → the **PC** tab, select **Include PC when synchronizing remotely and connect to**, and select your computer’s name. Remote synchronization with a desktop computer will work only if a partnership is set up with that computer through ActiveSync and ActiveSync is set to allow remote connections. Other restrictions apply. For more information, see *ActiveSync Help* on the desktop computer.

To start the connection, simply start using one of the programs listed in the preceding section. Once connected, you can perform the same activities as listed in the preceding section.

## Ending a Connection

To disconnect, do one of the following:



- When connected via dial-up or VPN, tap the **Connection** icon (*shown left*) on your navigation bar, and then tap **End**.
- When connected via cable or cradle, detach your 700 Series Computer from the cable or cradle.
- When connected via Infrared, move the 700 Series Computer away from the PC.
- When connected via a network (Ethernet) card, remove the card from your 700 Series Computer.

## Connecting Directly to an E-mail Server

You can set up a connection to an e-mail server so that you can send and receive e-mail messages by using a modem or network connection and In-box on your 700 Series Computer.



**Note:** The ISP or network must use a POP3 or IMAP4 e-mail server and an SMTP gateway.

You can use multiple e-mail services to receive your messages. For each e-mail service you intend to use, first set up and name the e-mail service. If you use the same service to connect to different mailboxes, set up and name each mailbox connection.

## Setting Up an E-mail Service

- In Inbox on your 700 Series Computer, tap **Services** → **New Service**. Follow the directions in the New Service wizard.

For an explanation of a screen, tap **Start** → **Help**. When finished, to connect to your e-mail server, tap **Services** → **Connect**. For more information on using the Inbox program, see “*Inbox: Sending and Receiving E-mail Messages*” on page 42.





# **3** Installing Applications

There are multiple ways to get an application to your 700 Series Color Mobile Computer; just as there are multiple ways to package the application for delivery.

## Packaging an Application

Use any of the following methods to package an application for installation:

- For very simple applications, the application itself might be the only file that needs to be delivered.
- It could be a directory structure that contains the application, supporting files like ActiveX controls, DLLs, images, sound files, and data files.
- Via a CAB file.

Consider either of the following when choosing a location into which to store your application:

- In the basic 700 Series Computer, there are no built-in storage options other than the Object Store. The Object Store is RAM that looks like a disk. Anything copied here will be deleted when a cold-boot is performed on the 700 Series Computer.
- If the optional SecureDigital or CompactFlash storage card is in the system, then consider this card the primary location for placing an application's install files. The following folders represent either card:
  - The SecureDigital storage card creates the “\SDMMC Disk” folder.
  - The CompactFlash storage card creates the “\Storage Card” folder.
- Files copied to either of these locations will be safe when a cold-boot is performed on a 700 Series Computer - *providing the AutoRun system is installed onto the storage card*. You can find this system on the Recovery CD. Copying a CAB file to the “\CABFILES” folder on one of these cards will automatically extract that CAB file on every cold boot to ensure that your system is properly set up. See page 82 for more details on how this works.

## Installing Applications

Consider any of the following options to get the package to the preferred location on your 700 Series Computer.

- Microsoft ActiveSync
- FTP Server (*page 78*)
- Application Manager in Unit Manager (*page 78*)
- SecureDigital or CompactFlash storage card (*page 78*)



## Using Microsoft ActiveSync



**Note:** These instructions assume that the 700 Color Management Tools portion of the *700 Series Color Software Tools CD* was installed onto your desktop.

The Microsoft ActiveSync tool is located on the 700C Companion CD, which contains Microsoft products, such as Outlook and ActiveSync. See Chapter 2, “*Pocket PC 2002*,” for information about this tool as provided by Microsoft Corporation.

This can be a serial, USB, Ethernet, InfraRed, or 802.11b ActiveSync connection. Files can then be copied using File Explorer on a PC or a laptop computer. This option is usually only good when updating a few 700 Series Computers.

These instructions assume that Microsoft ActiveSync had been installed onto your desktop computer and is up and running. If not, go to Chapter 2, “*Pocket PC 2002*,” for an URL from which you can download the latest application.

- 1 Connect your 700 Series Computer to your desktop computer via an ActiveSync cable or IrDA.
- 2 Wait for a “Connected” message to appear in the Microsoft ActiveSync application to signal a connection to the 700 Series Computer. If necessary, select **File** → **Get Connected** to initiate a connection.

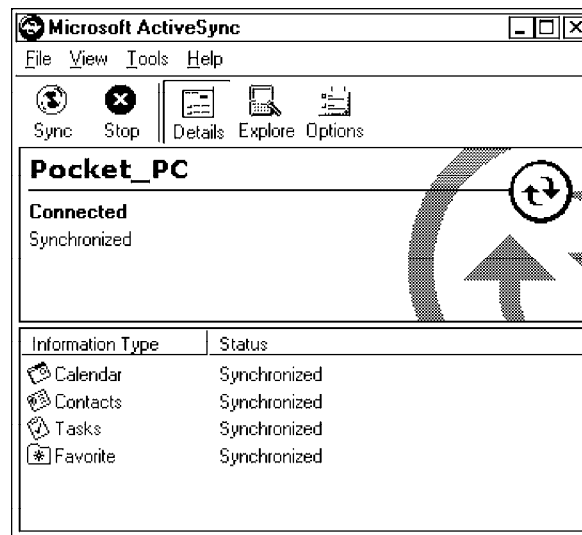

- 3 Click **Explore** to access the Mobile Device directory on your 700 Series Computer.

- 4 From your desktop, select **Start** → **Windows Explorer**, then browse the applicable path for any of the system files needed for your 700 Series Computer (*listed with their paths*). Select to highlight the appropriate file, right-click the file for a pop-up menu, then select **Copy**.
  - Base operating system files:  
“C:\Intermec\Intermec 700 Color Mgmt Tools\Drive Images”
  - CAB files:  
“C:\Intermec\Intermec 700 Color Mgmt Tools\Cab Files”
- 5 Within the Mobile Device directory, go to the directory where you want the files located on the 700 Series Computer, do a right-click for a pop-up menu, then select **Paste**.
- 6 When all of the files are pasted, perform a warm-boot on the 700 Series Computer. When the computer reboots, wait for the LED on the top left of your keypad to stop blinking. Tap **Start** → **Programs** → **File Explorer** to locate the newly copied executable files, then tap these files to activate their utilities.

## Using the FTP Server

The 700 Series Computer has a built-in FTP Server that connects to a network via Ethernet or 802.11b. This “ftp”s to the IP address of the 700 Series Computer and places files. The benefit of using FTP is that a script can be created that will automate the process of copying files to the 700 Series Computer. This option is good for when a large number of 700 Series Computers need to be updated. See Chapter 7, “*Programming*,” for more information.

## Using the Application Manager in Unit Manager

This requires the 700 Series Computer to connect to the network via Ethernet or 802.11b. The process is still manual so it would take longer than the FTP method but it would still be a better option than ActiveSync where many 700 Series Computers need to be updated. The Unit Manager applications are available on the *700 Series Color Unit Manager CD-ROM*. For more information, consult your Intermec sales representative.

## Using a Storage Card

The following steps pertain to installing an application using a storage card.

### Copying to a CompactFlash Card

Follow the steps below to install your application on the device using a CompactFlash storage card:

- 1 Suspend the 700 Series Color Mobile Computer and remove its CompactFlash drive, which holds a SanDisk CompactFlash storage card.
- 2 Using a CompactFlash Adapter card, place the CompactFlash Drive in your desktop PC card drive.

- 3 Create a subdirectory on the PCMCIA CompactFlash drive in which to store your application.
- 4 Add the autorun system to the storage card using the CEImager application. See the *Software Tools User's Manual* for information about CEImager.
- 5 Copy your application, data files, and all required DLLs and drivers to the subdirectory created on the CompactFlash drive.
- 6 Add your application to the AUTOUSER.DAT file on the “\Storage Card\2577” directory that contains the following statement, where *your directory* is the directory on the CompactFlash storage card where the application was installed, and *yourapp.exe* is the name of your application. Finish the “RUN=” statement with a carriage return line-feed combination. There may be multiple run statements in the file.  

```
RUN=\<your di rectory>\<yourapp. exe>
```
- 7 Remove the CompactFlash drive from your desktop computer and reinstall it into the 700 Series Computer.
- 8 Warm-boot the 700 Series Computer to add these files to the CompactFlash storage card.

If the AUTOUSER.DAT file is found and the “RUN=” statement is correct, then the task manager will launch and execute your program on start-up.

### Copying to a SecureDigital Storage Card

Do the same steps as for the CompactFlash storage Card, except replace the “\Storage Card\2577” directory with the “\SDMMC Disk\2577” directory.

## Updating the System Software

You can use the Recovery CD to reinstall or update the operating system software on the 700 Series Color Computer. For more information, contact your Intermec sales representative.

## Application Migration



**Note:** These instructions assume that the 700 Color Management Tools portion of the 700C Software Tools CD was installed onto your desktop and that a storage card has been added to the base configuration of the 700 Color Computer.

The following steps are required to ensure that the following will happen on a cold-boot:

- CAB files can be restored,
- applications will automatically start,
- and the registry will be restored.

Do the following for the cold-boot procedure:



- 1 From your desktop, double-click the **Intermec CE Imager** desktop icon to access the Intermec CEImager application. If this icon is not on your desktop, then double-click the CEIMAGER.EXE executable from the “C:\Intermec\Intermec 700 Color Mgmt Tools\Tools\CEImager” folder.
- 2 Click **Default** under **Components List** to activate the components.
- 3 Click (+) to expand the **AutoRun System** component, click (+) to expand the **Destination Media** option, then select *either* the **Compact-Flash Card** option or the **SecureDigital Card** option. *Do not select both storage cards, as the AutoRun files copied will work for one storage card, but not work on the other storage card.*

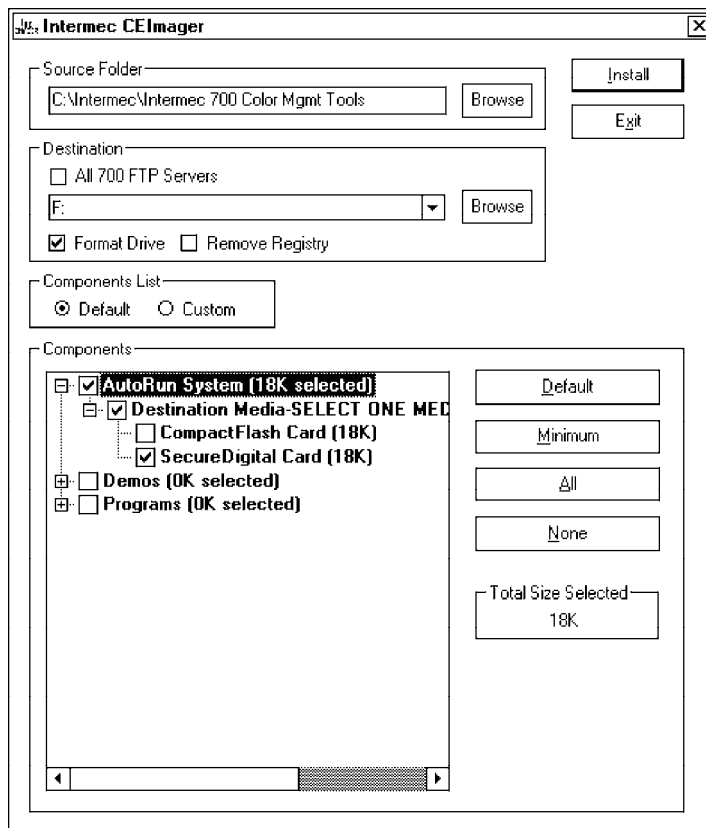

- 4 Click **Install** to install the AUTORUN files onto the storage card.
- 5 Create a “\Cabfiles” folder on the storage card. Copy any CAB files that are to be extracted on every startup into this folder.
- 6 In the “\2577” directory, add your custom AUTOUSER.DAT file. See the *Recovery Help* for more information on how to set up an AUTOUSER.DAT file.
- 7 If you are using the RegFlushKey() API, the application must use a special API to make sure the registry is written to the appropriate card; or you can use the **Utilities** control panel applet, as follows:



- a From the 700 Series Computer, tap **Start** → **Settings** → the **System** tab → the **Utilities** icon → the **Registry Save** tab.
- b Tap **Enable Registry Storage**, then tap either of the following:
  - **SD**  
To write the registry to the SecureDigital storage card.
  - **CF**  
To write the registry to the CompactFlash storage card.
- c Tap **ok** to save your entry and exit the **Utilities** control panel applet.

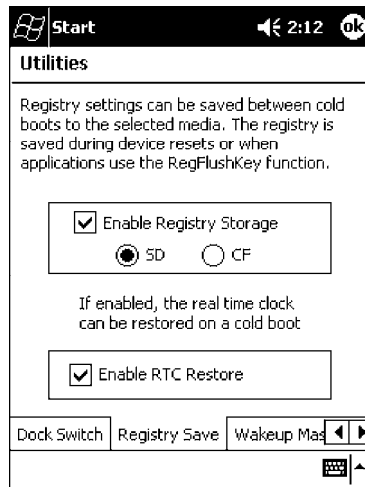

**Note:** If you are using a SecureDigital storage card, you must change any disk access from “Storage Card” to “SDMMC Disk.”

- 8 Remove the storage card from the desktop PC and install the card into the 700 Series Color Computer.
- 9 Perform a cold-boot on the 700 Series Color Computer. Files will automatically install from the storage card upon reboot. Any calls to the RegFlushKey() API will automatically write the registry to the appropriate location.

When converting a 700 Series Monochrome Computer application to run on the 700 Series Color Computer, most APIs should work without changes. Below are a few exceptions:

- The 700 Series Monochrome Computer used the “\Storage Card” folder for nonvolatile storage. You may need to change the application to store data in a volatile location or onto the “SDMMC Disk” if a SecureDigital storage card is present in the system.
- If the application uses the RegFlushKey() API, it must first verify that the proper media is available in the system and call the special API mentioned in Step 7 on the previous page.
- If the application will be using the 700 Color switchable dock, use the API to set the proper port on the dock before communications.
- Some WAN radio options have changed. Review the WAN radio section to determine if any changes will be required in your application.
- The arrow and tab keys are swapped from the way they were on the 700 Series Monochrome Computers. Keyboard remapping is available on the 700 Series Color Computer if these keys need to be changed. See page 79 for more details.
- No special SDK is needed to compile applications for the Xscale processor. Targeting the SA1110 processor will create applications that run on the 700 Series Color Computer.

## Cabinet File Installation

CAB files (*short for cabinet files*) are like .ZIP files, plus they register DLLs, create shortcuts, modify registry entries, and run custom set up programs. Tap a CAB file to extract that file or place the CAB file on one of the approved storage devices in the “\Cab Files” folder, then perform a warmboot on the 700 Series Computer. There are two methods available to extract a CAB file:

- Tap a CAB file to extract it. When using this method, the CAB file is automatically deleted when the extraction process is successful, *unless* the CAB file is set with the read-only attribute.
- Use the AUTOCAB method where all files are extracted when a coldboot is performed on the 700 Series Computer. This AutoCab application is on the Recovery CD, see its “*Recovery Help*” for more information.



# 4 Network Support

The 700 Series Color Mobile Computer can integrate up to three radios in a single unit, and will automatically install the appropriate software for radio use when the unit is powered on. The Intermec CORE application defaults to the most recently used module. If a module has not yet been used or set, CORE will default to the first module as listed alphabetically.

The following communication options on the 700 Series Computer provide wired and wireless connectivity:

- **Onboard wired Ethernet** (*standard*)
- **Wireless Local Area Network (LAN)**  
This 802.11b radio option provides up to 11 Mb/sec throughput.
- **Wireless Wide Area Network (WAN)**  
Includes support for GSM/GPRS and CDMA/1xRTT radios.
- **Wireless Printing**  
This allows for cable-free communications with peripheral devices, such as printers, over a ten-meter range. This compatibility is provided via a Bluetooth qualified module by Socket Communications.

## CORE

The Intermec Common Object Resource Environment (CORE) application provides a framework for various modules that let you configure and manage your Intermec products. These modules are software plug-ins that can be configuration tools, such as the 802.11b radio configuration module, or they can provide information on your environment, such as a battery life module.



CORE is built into the operating system of every 700 Series Computer. On the 700 Series Computer, tap **Start** → **Programs** → the **Intermec CORE** icon to access this application.

CORE modules are collections of specific information. This information is usually related to a particular radio technology, but not always. Each module can display general and detailed information. Tap the **General** and **Details** tabs near the bottom to switch between general and detailed information. Note that not all modules will have detailed information.

To learn more about this application, see its online help. Tap **Start** → **Help** from the menu to see the CORE online help.



**Note:** Once CORE is running, you can return to it by tapping its icon from the System Tray via the Today screen. Tap **Start** → **Today** → the **Intermec CORE** three-ring icon (*circled in the following illustration*).

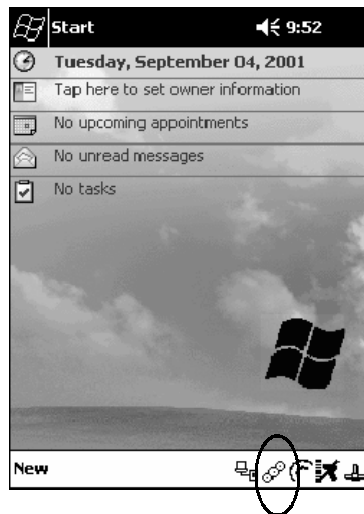



## Network Adapters

Your 700 Series Computer can have up to three radios installed. The default network adapter or radio is dependent on what card is inserted in your 700 Computer. Below are the the network adapters that exist as of this publication. See the Developer's Support web site for the latest information on network adapters for your unit.

- Ethernet Communications (*LAN9000*) - page 86.
- 802.11b Radios (*802.11b Wireless LAN driver*) - page 87.
- WWAN (*Wireless WAN*) - page 110.
- Wireless Printing (*PAN*) - page 120.

Note that the tip of the antenna attached to your 700 Series Computer is color-coded to identify its radio type. Refer to the following to determine your radio type:

- **Green**  
802.11b diversity
- **Red**  
CDMA (non-Sprint networks)
- **White**  
GPRS US/Canada and CDMA Sprint networks
- **Blue**  
GPRS International

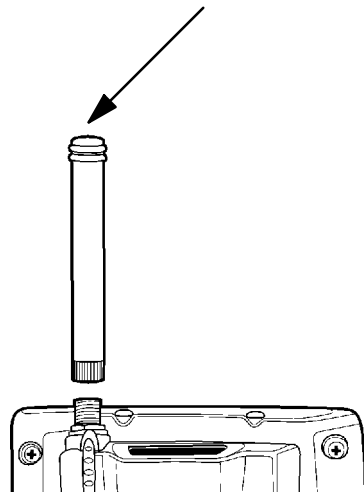

## Ethernet Communications

Follow the steps below to start Ethernet communications on the 700 Series Computer. If your system does not contain an 802.11b radio, then **Ethernet networking using DHCP** will be selected as the default.



When “Built-in Ethernet” is selected from the NDISTRY pop-up menu, then the antenna shown to the left will appear in the System Tray. When “No networking” is selected, then this icon will appear with a red “X” above it.

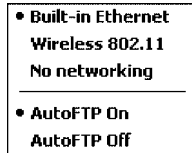

From the 700 Series Computer, tap **Start** → **Settings** → the **Connections** tab → **Network Adapters** to access the network connections for this unit. Make the changes necessary for your network, then tap **ok** when finished.

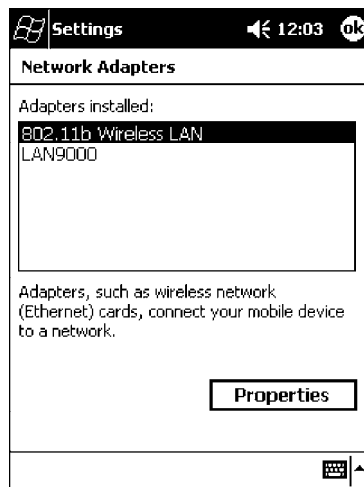

**Note:** “LAN9000” is for Ethernet and ”802.11b Wireless LAN” is for 802.11b radios.

## 802.11b Communications

The 700 Series Computer can integrate the 802.11b radio module along with either the GSM/GPRS or the CDMA/1xRTT radio and the Wireless Printing option. The 802.11b radio module accommodates any Wireless LAN (WLAN) requirements, such as using WLAN access points for cross-docking or load-planning applications.



When “Wireless 802.11” is selected via the NDISTRY pop-up menu, then the antenna shown to the left will appear in the System Tray.

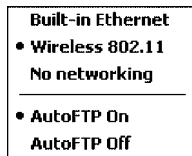

To start 802.11b communications on the 700 Series Computer, tap **Start** → **Settings** → the **System** tab → the **Wireless Network** icon to access the Profile Wizard for the 802.11b radio module. The Profile Wizard defaults to the Profiles page.

### Profiles

Use the Profiles page to add, edit, or delete multiple networking environments for this 802.11b radio. To add a profile from this screen, enter up to 32 alphanumeric characters in the **Profile** field, then tap **Add**. See “*Basic*” on page 89 and “*Security*” on page 90 for more information.

Leave **Use Profile Name for SSID** checked for the SSID (or Network Name) to use this profile name. If this is cleared (check mark removed), the SSID will default to using the factory-assigned “INTERMEC” network name.

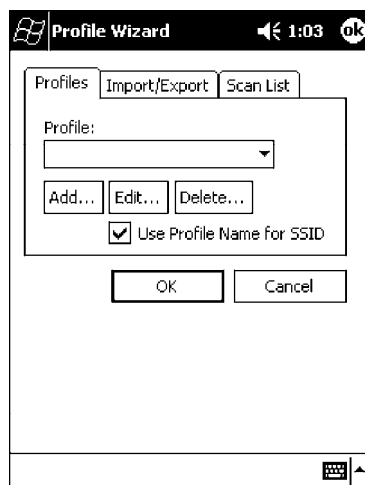

- **To add a profile:**  
Tap **Add**, enter up to 32 alphanumeric characters to name this profile if you have not already entered a description in the Profiles page, configure the basic and security information for this profile, then click **Done** to configure its basic and security information.
- Leave **Use Profile Name for SSID** checked for the SSID to use this assigned profile name. If this is cleared (check mark removed), the SSID will default to using the factory-assigned “INTERMEC” network name. Go to the next page to continue.

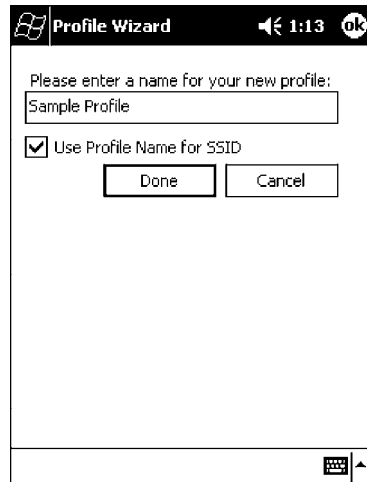

- **To edit a profile:**  
Select an existing profile from the **Profile** drop-down list, tap **Edit**, make the changes needed for this profile (starting in the next paragraph), then tap **OK** to return to the Profiles page.
- **To delete a profile:**  
Select a profile from the **Profile** drop-down list, tap **Delete**, then tap **Yes** to remove the selected profile.

## Basic

Use the Basic page to set the network type and radio channel for this profile. Click **OK** to return to the Profiles page.

- **Network type:**  
Tap the drop-down list to select either Infrastructure or Ad-hoc.
- **SSID (Network Name):**  
This assumes the profile name when **Use Profile Name for SSID** is checked on the previous screen, *unless another name is entered in this field*. If you want to connect to the next available network or are not familiar with the network name, enter “ANY” in this field. Consult your LAN administrator for network names.
- **Channel:**  
If “Ad-hoc” were selected as the network type, then this is enabled. Tap the drop-down list to select a channel, from 1-15, through which to handle connections (*default is 3*).
- **Enable Power Management:**  
Check this box to conserve battery power (*default*), or clear this box to disable this feature.

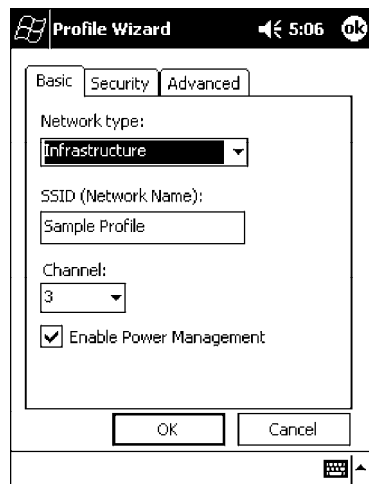

## Security

Use the Security page to set this profile as read-only or to enable WEP (Wired Equivalent Privacy) encryption. Click **OK** to return to the Profiles page. The following securities are available from the **Security Method** drop-down list. *Note that the last three methods are available if you have purchased the security package. Contact your Intermec Representative for more information.*

- 802.11 WEP Encryption (*next page*)
- 802.1x TLS (*page 92*)
- 802.1x TTLS (*page 93*)
- LEAP (*page 93*)

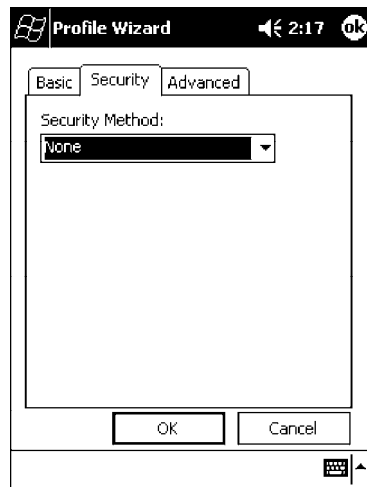

**802.11 WEP Encryption:**

WEP keys are only needed if they are expected by your clients. There are two types available: 64-bit (5-character strings, 12345) (*default*) and 128-bit (13-character strings, 1234567890123). These can be entered as either ASCII (12345) or Hex (0x3132333435).

To enter WEP keys, select “802.11 WEP Encryption” from the **Security Method** drop-down list. Select a data transmission key from the **Data TX Key** drop-down list near the bottom of this screen, then enter the encryption key for that data transmission in the appropriate **Key #** field.

The screenshot shows the 'Profile Wizard' dialog box with the 'Security' tab selected. The 'Security Method' dropdown is set to '802.11 WEP Encryption'. Below this, there are four text input fields labeled 'Key 1:', 'Key 2:', 'Key 3:', and 'Key 4:'. At the bottom of the main form area, there is a 'Data TX Key' dropdown menu currently set to 'Key 1'. The dialog has 'OK' and 'Cancel' buttons at the bottom, and a keyboard icon with an arrow in the bottom right corner.

**802.1x TLS** (*Transport Layer Security*):

TLS is a protocol that ensures privacy between communicating applications and their users on the Internet. To use this protocol, select “802.1x TLS” from the **Security Method** drop-down list, then enter the following:

- **Client Key File:**  
Enter the file location where the certificate for your identity is stored.
- **Password:**  
Enter the password for the certificate in this field.
- **Supplicant ID:**  
Enter the user ID associated with this certificate.
- **Server Cert CN** (*Certificate Common Name*):  
Enter the common name of your authentication server.
- **CA List** (*Certificate Authority*):  
Enter the file location, or path, of the server certificates.

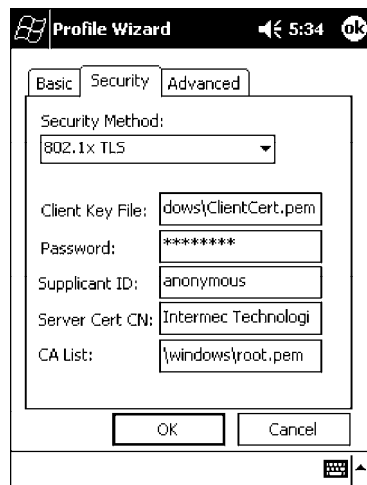



**802.1x TTLS (EAP-Tunneled TLS):**

To use this protocol, select “802.1x TTLS” from the Security Method drop-down list, then enter the following:

- **Username:**  
Enter your user name for this security protocol.
- **Password:**  
Enter your password for this security protocol.
- **Supplicant ID:**  
Enter “anonymous” unless your administrator indicates otherwise.
- **Server Cert CN (Certificate Common Name):**  
Enter the common name of your authentication server.
- **CA List:**  
Enter the file location, or path, of the server certificates.

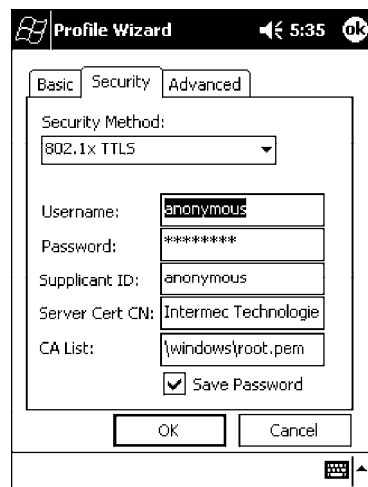
**LEAP (Cisco Wireless EAP (Extensible Authentication Protocol)):**

Enter your unique user name and password to use this protocol.

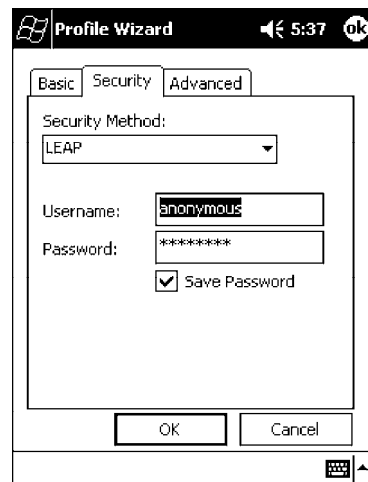

## Advanced

Use this page to secure the configuration for this profile or to make all fields read-only.

- **Make Profile Read-Only:**  
Check this box, then enter and reenter a password to “lock” or render “read-only” all configurations for this profile. To reverse this step, clear the check box, then enter the password assigned with the “read-only” status.
- **Certificates:**  
If “802.1x TLS,” “802.1x TTLS,” or “LEAP” were enabled via the **Security** tab, then this button will appear. Tap this button to configure the available certificates. See “*Certificates*” on the next page for more information.

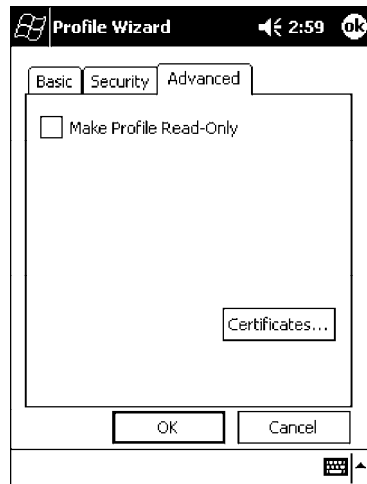

## Certificates

Use this page to view, modify, or remove certificates assigned to your particular security method. *Note that you can also access this page by tapping **Start** → **certificates** from the **Today** screen.*

- **CA Name/IP:**  
Enter a valid CA name or IP address assigned to the certificate in question. This allows you to enroll the certificate or to browse for its latest information.
- **Enroll File Name:**  
Enter the file name of the certificate to be enrolled.
- **Store Location:**  
Enter the path where the certificate is to be stored within your 700 Series Computer.
- **Enroll:**  
Tap this to assign the file entered in **Enroll File Name** to the location specified in **Store Location**.
- **CA Vert:**  
Tap this to view the contents of the certificate via the Internet Explorer.
- **View:**  
Tap this to view information about the certificate, such as to whom this certificate was issued, who issued the certificate, and the span of time the certificate is valid.
- **Remove:**  
Select a file from the list, then tap this button to delete that file.

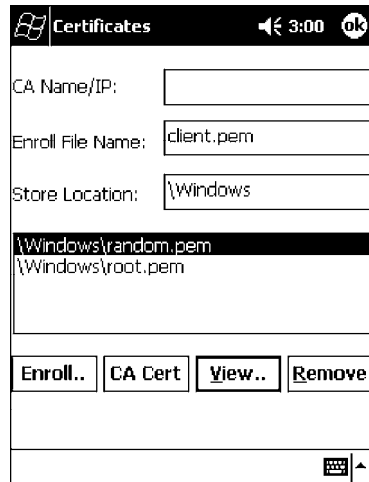

## Import/Export

Use this page to send a profile or to retrieve a profile to or from another location within your 700 Series Computer.



- **To export a profile:**  
Select to highlight a profile, then tap **Export**. Select from the drop-down lists, the folder, type of files, and location within the folder where the profile is to go, tap **OK** to export the profile, tap **ok** to close the confirmation screen, then tap **OK** again to exit the Profile Wizard.

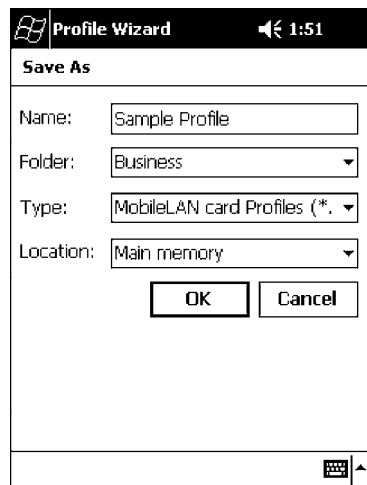

- **To import a profile:**  
Tap **Import** to access the Open screen, from the drop-down lists, select a folder and file type, then tap a profile from the list provided. Tap **ok** to close the confirmation screen, then tap **OK** again to exit the Profile Wizard.

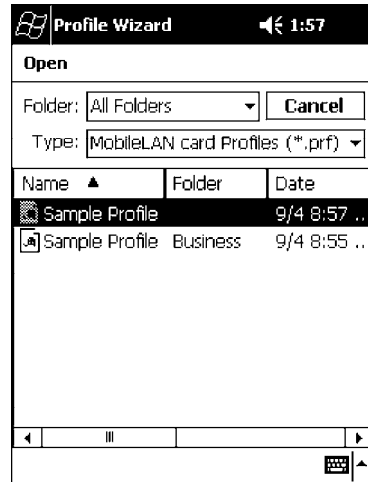

### Scan List

Use this Scan List page to monitor network connections, and if lost, to attempt to reestablish connections with these networks.

### Selected Profile

Select this option to use the profile defined in the Profiles page, then tap **OK** to exit the Profile Wizard. When connections are lost, attempts will be made to connect to the specified profile.

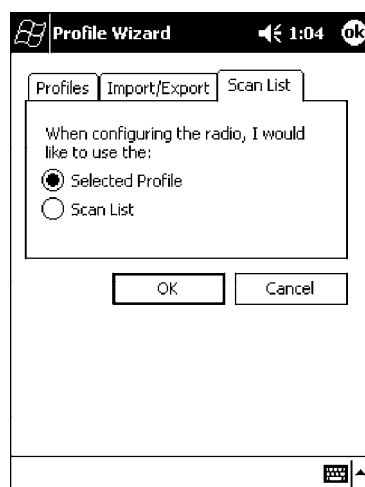

## Scan List

Use this option to select a number of profiles with which to establish connections. When connections are lost, attempts will be made to contact each of the profiles listed, in the order they appear in the list.

- 1 Tap this option, then tap **Edit Scan List**.
- 2 Select profiles from the **Available Profiles** drop-down list, then tap **Add** to include each selection in the Scan List.
- 3 To arrange the hierarchy of profiles, tap to select a profile, then tap either **Move Up** or **Move Down** to move each profile. To remove a profile from the list, tap to select that profile, then tap **Delete**.
- 4 Click either **ok** or **Close** to return to the Scan List page, then click **OK** to exit the Profile Wizard.

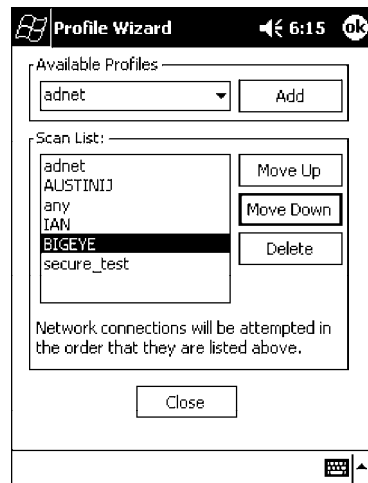

## Network Selection APIs

The Network Selection APIs allow the user to change network adapter configuration programmatically. Both drivers support the same IOCTL function numbers for loading and unloading the drivers.

Loading and unloading of the 802.11b driver is performed by the FWV1: device in the system by performing DeviceIOControl() calls to the driver.

Loading and unloading of the driver for the built-in Ethernet adapter is performed by the SYI1: device in the system by performing DeviceIOControl() calls to the driver.

- For loading an NDIS driver associated with an adapter, the IOCTL is IOCTL\_LOAD\_NDIS\_MINIPORT.
- For unloading NDIS drivers associated with an adapter the IOCTL is IOCTL\_UNLOAD\_NDIS\_MINIPORT.

```

#include <winioctl.h>
#include "sysio.h"
void DoLoad(int nDevice) {
    LPTSTR devs[] = { _T("SYSI:"), _T("FWV:") };
    HANDLE hLoaderDev;
    DWORD bytesReturned;
    hLoaderDev = CreateFile(devs[nDevice], GENERIC_READ|GENERIC_WRITE, 0,
        NULL, OPEN_EXISTING, 0, NULL);
    if (hLoaderDev != INVALID_HANDLE_VALUE) {
        if (!DeviceIoControl(hLoaderDev, IOCTL_LOAD_NDIS_MINIPORT, NULL, -1, NULL, 0,
            &bytesReturned, NULL)){
            MessageBox(NULL, TEXT("SYSIO IoControl Failed"), TEXT("Network
                loader"), MB_ICONHAND);
            if (hLoaderDev!=INVALID_HANDLE_VALUE) CloseHandle(hLoaderDev);
            hLoaderDev = INVALID_HANDLE_VALUE; // bad handle
        }else {
            CloseHandle(hLoaderDev);
        }
    }
}

void DoUnload(int nDevice) {
    LPTSTR devs[] = { _T("SYSI:"), _T("FWV:") };
    HANDLE hLoaderDev;
    DWORD bytesReturned;
    hLoaderDev = CreateFile(devs[nDevice], GENERIC_READ|GENERIC_WRITE, 0,
        NULL, OPEN_EXISTING, 0, NULL);
    if (hLoaderDev != INVALID_HANDLE_VALUE) {
        if (!DeviceIoControl(hLoaderDev, IOCTL_UNLOAD_NDIS_MINIPORT, NULL, -1, NULL, 0,
            &bytesReturned, NULL)){
            MessageBox(NULL, TEXT("SYSIO IoControl Failed"), TEXT("Network
                loader"), MB_ICONHAND);
            if (hLoaderDev!=INVALID_HANDLE_VALUE) CloseHandle(hLoaderDev);
            hLoaderDev = INVALID_HANDLE_VALUE; // bad handle
        }else {
            CloseHandle(hLoaderDev);
        }
    }
}
}

```

The API provided by Intermec Technologies exposes a limited set of routines that allows a programmer to access and affect the 802.11b network interface card from within their application. The routines provided will also read/write values to the CE registry that pertain to the 802.11b radio driver. By using the provided functions, a programmer can alter the 802.11b parameters of Network Name (SSID), WEP Keys, Infrastructure Modes, Radio Channel, and Power Management Modes. A programmer can also retrieve network connect status and signal strength indication from the RF network card.

The API is contained within the 80211API.DLL file that should be present in any load that has the 802.11b networking installed.

- **NETWLAN.DLL**  
This file is the 802.11b driver. It will be present in all 700 CE loads that use the 802.11b network interface card.
- **80211API.DLL**  
This file is an Intermec authored file that provides the programmer with a set of API calls to configure or monitor status of the 802.11b network.
- **MOD80211.DLL**  
The CORE module for the 802.11b NIC. It provides the 802.11b status information displayed when the CORE application is running.
- **80211CONF.EXE**  
This is the “Control Panel” for configuring the 802.11b network parameters. Note that it is an EXE file and is actually called by CPL802.CPL (see below). It is also called by the CORE application when the “Configuration” button is pressed.
- **CPL802.CPL**  
A control panel application that does nothing but call 80211CONF.EXE.
- **80211SCAN.EXE**  
Internally manages the Scan List activity.

The 80211API.DLL supports an unlimited number of radio configuration profiles. These profiles are the same as those set by the **Wireless Network** control panel applet that runs on the Windows CE unit. You can configure different 802.11b profiles and switch between them using the 802.11 API. See the `ConfigureProfile()` function on page 106 for more information.



## Function Summary

Below are functions available for the 700 Series Color Computer when enabled with the 802.11b radio module.

### RadioConnect()

Connects to the available radio. Use this function if you plan on using a lot of API calls that talk directly to the radio.

**Syntax:** `UINT RadioConnect( );`

**Parameters:** None.

**Returns:** `ERROR_SUCCESS` when successful, otherwise `ERR_CONNECT_FAILED`.

### RadioDisconnect()

Cleans up the connection from the `RadioConnect()` function after an application closes.

**Syntax:** `UINT RadioDisconnect( );`

**Parameters:** None.

**Returns:** `ERROR_SUCCESS` when successful, otherwise `ERR_CONNECT_FAILED`.

### GetMac()

Gets the radio MAC address.

**Syntax:** `UINT GetMac( TCHAR * );`

**Parameters:** Pointer to a character array, which is populated with MAC addresses.

**Returns:** `ERROR_SUCCESS` when successful, `ERR_QUERY_FAILED` when the query failed, or `ERR_CONNECT_FAILED` if a connection with the radio failed.

### GetBSSID()

Gets the associated access point name, the BSSID.

**Syntax:** `UINT GetBSSID( TCHAR * );`

**Parameters:** Pointer to a character array, which is populated with the current BSSID.

**Returns:** `ERROR_SUCCESS` when successful, `ERR_QUERY_FAILED` when the query failed, or `ERR_CONNECT_FAILED` if a connection with the radio failed

### GetSSID()

Gets the current SSID (network name).

**Syntax:** `UINT GetSSID( TCHAR * );`

**Parameters:** Pointer to a character array, which is populated with the current SSID.

**Returns:** `ERROR_SUCCESS` when successful, `ERR_QUERY_FAILED` when the query failed, or `ERR_CONNECT_FAILED` if a connection with the radio failed.

### GetLinkSpeed()

Retrieves the current link speed of the radio connection.

**Syntax:** `UINT GetLinkSpeed( int & );`

**Parameters:**  References an integer.

**Returns:** ERROR\_SUCCESS when successful,  
ERR\_QUERY\_FAILED when the query failed, or  
ERR\_CONNECT\_FAILED if a connection with the radio failed.

### GetNetworkType()

Retrieves the network type.

**Syntax:** `UINT GetNetworkType( ULONG & );`

**Parameters:**  References a ULONG value, populated with one of the following:  
NDIS\_NET\_TYPE\_FH Frequency Hopping Radio  
NDIS\_NET\_TYPE\_DS Direct Sequence Radio  
NDIS\_NET\_TYPE\_UNDEFINED  
Unknown or information not available.

**Returns:** ERROR\_SUCCESS when successful,  
ERR\_QUERY\_FAILED when the query failed, or  
ERR\_CONNECT\_FAILED if a connection with the radio failed.

### GetTXPower()

Gets the current TX power of the radio in milliwatts.

**Syntax:** `UINT GetTXPower( ULONG & );`

**Parameters:**  References a ULONG value, populated with one of the following in milliwatts (mW):

NDIS_POWER_LEVEL_63	63 mW.
NDIS_POWER_LEVEL_30	30 mW.
NDIS_POWER_LEVEL_15	15 mW.
NDIS_POWER_LEVEL_5	5 mW.
NDIS_POWER_LEVEL_1	1 mW.
NDIS_POWER_LEVEL_UNKNOWN	

Unknown Value or Error.

**Returns:** ERROR\_SUCCESS when successful,  
ERR\_QUERY\_FAILED when the query failed, or  
ERR\_CONNECT\_FAILED if a connection with the radio failed.

**GetNetworkMode()**

Retrieves the network mode.

**Syntax:** `UINT GetNetworkMode( ULONG & );`

**Parameters:** *☞* References a ULONG value, populated with one of the following:

<code>NDIS_NET_MODE_IBSS</code>	802.11 Ad-Hoc Mode.
<code>NDIS_NET_MODE_ESS</code>	802.11 Infrastructure Mode.
<code>NDIS_NET_MODE_UNKNOWN</code>	Unknown Value or Error.
<code>NDIS_NET_AUTO_UNKNOWN</code>	Automatic Selection. <i>Use of this option is not recommended.</i>

**Returns:** `ERROR_SUCCESS` when successful,  
`ERR_QUERY_FAILED` when the query failed, or  
`ERR_CONNECT_FAILED` if a connection with the radio failed.

**SetNetworkMode()**

Sets the radio and updates the CE registry.

**Syntax:** `UINT SetNetworkMode( ULONG & );`

**Parameters:** *☞* References a ULONG value, populated with one of the values defined in `GetNetworkMode()`.

**Returns:** `ERROR_SUCCESS` when successful,  
`ERR_QUERY_FAILED` when the query failed, or  
`ERR_CONNECT_FAILED` if a connection with the radio failed.

**AddWep()**

Adds a WEP key to the radio configuration.

**Syntax:** `UINT AddWep( ULONG 1, BOOL 2, TCHAR * 3 );`

**Parameters:** *ULONG* Pointer that identifies what key to be set.  
*BOOL* Specifies whether the key being set is the default TX key.  
*TCHAR* Pointer that specifies the key data either in hex (string lengths of 10 or 26) or ASCII (string lengths of 5 or 13).

**Returns:** `ERROR_SUCCESS` when successful,  
`ERR_QUERY_FAILED` when the query failed, or  
`ERR_CONNECT_FAILED` if a connection with the radio failed.

**GetRSSI()**

Sets the current RSSI (Received Signal Strength Indication).

**Syntax:** `UINT GetRSSI( ULONG & );`

**Parameters:** *☞* References a ULONG value.

**Returns:** `ERROR_SUCCESS` when successful,  
`ERR_QUERY_FAILED` when the query failed, or  
`ERR_CONNECT_FAILED` if a connection with the radio failed.

### GetAssociationStatus()

Gets the current connection, or association status.

**Syntax:** `UINT GetAssociationStatus( ULONG & );`

**Parameters:**  References a ULONG value, a current connection status as follows:  
NDIS\_RADIO\_ASSOCIATED Radio is associated w/access point.  
NDIS\_RADIO\_SCANNING Radio is scanning for network.

**Returns:** ERROR\_SUCCESS when successful,  
ERR\_QUERY\_FAILED when the query failed, or  
ERR\_CONNECT\_FAILED if a connection with the radio failed.

### GetWepStatus()

Gets the current WEP status.

**Syntax:** `UINT GetWepStatus( ULONG & );`

**Parameters:**  References a ULONG status value which include the following:  
NDIS\_RADIO\_WEP\_ENABLED WEP is currently enabled.  
NDIS\_RADIO\_WEP\_DISABLED WEP is currently disabled.  
NDIS\_RADIO\_WEP\_ABSENT WEP key is absent.  
NDIS\_RADIO\_WEP\_NOT\_SUPPORTED  
WEP is not supported.

**Returns:** ERROR\_SUCCESS when successful,  
ERR\_QUERY\_FAILED when the query failed, or  
ERR\_CONNECT\_FAILED if a connection with the radio failed.

### GetAuthenticationMode()

Gets the current authentication mode.

**Syntax:** `UINT GetAuthenticationMode( ULONG & );`

**Parameters:**  References a ULONG value which include the following current authentication mode:  
NDIS\_RADIO\_AUTH\_MODE\_OPEN Open System is in use.  
NDIS\_RADIO\_AUTH\_MODE\_SHARED Shared Key is in use.  
NDIS\_RADIO\_AUTH\_MODE\_AUTO Automatic Detection.  
NDIS\_RADIO\_AUTH\_MODE\_ERROR Unknown value/Error.

**Returns:** ERROR\_SUCCESS when successful,  
ERR\_QUERY\_FAILED when the query failed, or  
ERR\_CONNECT\_FAILED if a connection with the radio failed.

### SetAuthenticationMode()

Sets the radio authentication mode with a value defined in the GetAuthenticationMode() function.

**Syntax:** `UINT SetAuthenticationMode( ULONG );`

**Parameters:** Passes in a ULONG set to one of the values as defined in GetAuthenticationMode().

**Returns:** ERROR\_SUCCESS when successful,  
ERR\_QUERY\_FAILED when the query failed, or  
ERR\_CONNECT\_FAILED if a connection with the radio failed.

**SetChannel()**

Sets the radio channel, ranging from 1 to 14.

**Syntax:** `UINT SetChannel( USHORT );`

**Parameters:** USHORT set to a desired channel (1-14).

**Returns:** ERROR\_SUCCESS when successful,  
ERR\_QUERY\_FAILED when the query failed, or  
ERR\_CONNECT\_FAILED if a connection with the radio failed.

**EnableWep()**

Enables or disables WEP encryption.

**Syntax:** `UINT EnableWep( BOOL );`

**Parameters:** Set to TRUE (0) to enable WEP encryption or FALSE (1) to disabled WEP encryption.

**Returns:** ERROR\_SUCCESS when successful,  
ERR\_QUERY\_FAILED when the query failed, or  
ERR\_CONNECT\_FAILED if a connection with the radio failed.

**GetPowerMode()**

Gets the current power management mode of the radio.

**Syntax:** `UINT GetPowerMode( ULONG & );`

**Parameters:**  References a ULONG value which include the following current radio power management mode:

**NDIS\_RADIO\_POWER\_MODE\_CAM**

Continuous Access Mode (*uses most power*).

**NDIS\_RADIO\_POWER\_MODE\_MAX**

Maximum Power Savings.

**NDIS\_RADIO\_POWER\_MODE\_PSP**

Power Saving Mode, best balance of power and performance.

**NDIS\_RADIO\_POWER\_UNKNOWN**

Unknown mode reported or error.

**Returns:** ERROR\_SUCCESS when successful,  
ERR\_QUERY\_FAILED when the query failed, or  
ERR\_CONNECT\_FAILED if a connection with the radio failed.

**SetSSID()**

Passes the desired SSID (network name).

**Syntax:** `UINT SetSSID( TCHAR * );`

**Parameters:** Pointer to a character array that contains the desired SSID.

**Returns:** ERROR\_SUCCESS when successful,  
ERR\_QUERY\_FAILED when the query failed, or  
ERR\_CONNECT\_FAILED if a connection with the radio failed.

### **isOrinoco()**

Confirms whether the present radio is an ORiNOCO radio.

**Syntax:** `UINT isOrinoco( );`

**Parameters:** None.

**Returns:** TRUE when an ORiNOCO radio.  
FALSE when other than an ORiNOCO radio.

### **EncryptWepKeyForRegistry()**

Encrypts a key for registry storage. Requires TCHAR pointers for a destination and a source.

**Syntax:** `UINT EncryptWepKeyForRegistry( TCHAR * szDest, TCHAR * szSource );`

**Parameters:** *szDest* String for the destination.  
*szSource* String for the source.

**Returns:** ERROR\_SUCCESS when successful,  
ERR\_QUERY\_FAILED when the query failed, or  
ERR\_CONNECT\_FAILED if a connection with the radio failed.

### **SetRTSThreshold()**

Sets the radio RTS (Request To Send) threshold.

**Syntax:** `UINT SetRTSThreshold( USHORT & );`

**Parameters:**  References a USHORT value.

**Returns:** None.

### **GetRTSThreshold()**

Gets the radio RTS threshold.

**Syntax:** `UINT GetRTSThreshold( USHORT & );`

**Parameters:**  References a USHORT value.

**Returns:** None.

### **ConfigureProfile()**

If using the Intermec 802.11b Profile Management system, you can program the API to configure the radio to a specific profile by passing the profile name.

**Syntax:** `UINT ConfigureProfile( TCHAR * );`

**Parameters:** Pointer to a string that contains the name of the profile to be activated.

**Returns:** None.

**StartScanList()**

If a scan list is configured, this will start the API looking for a network on that scan list and configuring the radio appropriately. This call can take a long time to process.

**Syntax:** UINT **StartScanList( )**;

**Parameters:** None.

**Returns:** None.

**802.11b Radio CORE Module**

The 802.11b radio CORE module displays helpful information about the 802.11b radio option built into your 700 Series Computer.

Note that you can configure the 802.11b radio module from this CORE application. Select **Configure** → **Configure 802.11 CF** from the bottom menu bar to access the Profile Wizard application. Information about this application starts on page 87.

Select **Modules** → **Intermec 802.11 CF Help** for more information on the contents of this CORE module.

**General**

Below are descriptions and meanings for each piece of information provided via the **General** tab, reading from top to bottom starting on the left.

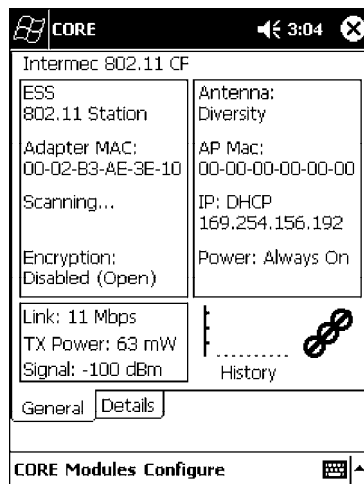

- **ESS 802.11 Station:**  
This identifies the type of network to which you are attached, either an ESS (Embedded Security Subsystem) Station, or Ad-hoc.
- **Adapter MAC:**  
This identifies the MAC address for this 802.11b adapter.
- **Scanning:**  
Status of association. When connected to a network, this changes to “Connected to NET” with NET being the name of the network to which you are connected.

- **Encryption:**  
This indicates whether WEP encryption is “Enabled” or “Disabled (Open).” See page 90 for more information.
- **Link:**  
This indicates the speed at which a connection is made.
- **TX Power:**  
This shows the speed (in milliwatts) at which transmissions are made.
- **Signal:**  
This identifies the radio signal strength (in dBm).
- **Antenna:**  
This identifies the antenna being used with the assigned profile.
- **AP Mac:**  
This identifies the MAC address of the access point to which this 700 Series Computer is connected.
- **IP:**  
This provides the IP address which can be set as either DHCP (Dynamic Host Configuration Protocol) or statically.
- **Power:**  
This indicates the power status of this 700 Series Computer: “Always On” is the default.
- **History:**  
This bar graph displays an active history of this radio module’s quality of connections.
- **Friendly Indicator:**  
If the radio stack is loaded, then all three dots are filled. These dots are left empty if the stack is not loaded. These dots do vary based on the CORE application’s perception of the overall connection quality.





## Details

Below are descriptions and meanings for each piece of information provided via the **Details** tab, reading from top to bottom.

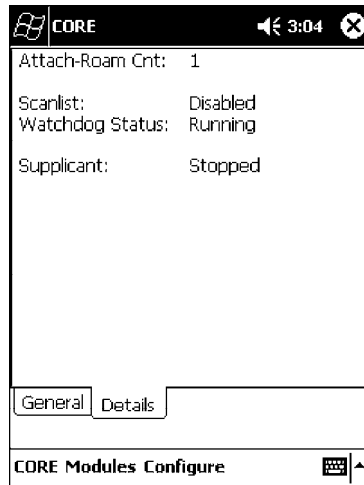

- **Attach-Roam Cnt:**  
This includes the number of new associations made during the current session, including any found roaming.
- **Scanlist:**  
This indicates whether the Scan List option was enabled or disabled. See page 97 for more information.
- **Watchdog Status:**  
This monitors the activity of the Scan List: “Running” or “Stopped.”
- **Supplicant:**  
This monitors the 802.1x security activity on the client: “Running” or “Stopped.”

## WWAN Radio Options

The 700 Series Computer can integrate either the GSM/GPRS or the CDMA/1xRTT radio along with the 802.11b radio and the Wireless Printing option. The WWAN radio option accommodates any Wireless WAN requirements, such as taking the 700 Series Computer off the premises in a delivery vehicle to cover a much larger area.

### GSM/GPRS

The GSM (Global System for Mobile communications) and GPRS (General Packet Radio Service) wireless infrastructure increases voice capacity, enables personalized “user-aware” services, and creates networking efficiencies to help wireless service providers drive reduced operating costs.

- **GSM** is an open, nonproprietary system. One of its great strengths is the international roaming capability. This provides seamless and same-standardized same-number contactability world-wide. GSM satellite roaming has extended service access to areas with unavailable terrestrial coverage.
- **GPRS** is the high-speed data evolution of GSM. GPRS supports Internet Protocol (IP), enabling access to Internet and intranet content and applications from GPRS wireless devices. The anticipated data rate for GPRS is 115 Kbps and throughput rates of 30-60 Kbps have been achieved initially. This high speed capability enables vehicle applications to become real-time and to use the Internet for access to corporate data or information in the form of traffic or navigation.

### CDMA/1xRTT SB555

Code Division Multiple Access (CDMA) is a form of “spread-spectrum,” a family of digital communication techniques used in military applications for years. The core principle of spread-spectrum is the use of noise-like carrier waves, and, as the name implies, bandwidths much wider than that required for simple point-to-point communication at the same data rate.

- **1XRTT**, the first phase of CDMA2000, is designed to support up to 144 KB per second packet data transmission and to double the voice capacity of current generation CDMA networks.
- **SB555 Embedded Module**, from Sierra Wireless, provides complete wireless functionality and integrates easily into the most compact and slender mobile applications with its small flexible design. The SB555 offers maximum coverage and access to entire CDMA networks.

## WAN Radio CORE Module

The WAN radio CORE module displays helpful information about either the GSM/GPRS radio or the CDMA/1xRTT radio option built into your 700 Series Computer. *The following illustrations are for a GSM/GPRS GEM350X radio.*

### General

Below are descriptions and meanings for each piece of information provided via the **General** tab, reading from top to bottom starting on the left. *The information applies to both the GSM/GPRS and the CDMA/1xRTT radio modules unless otherwise indicated.*

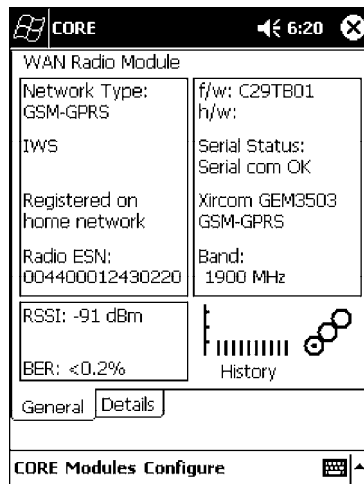

- **Network Type:**  
This is the network type which would list either “GSM-GPRS” or “CDMA-1XRTT.” *Scatternets are not supported.*
- **IWS (GSM/GPRS) or Sprint PCS Network (CDMA/1xRTT):**  
This lists the name of the wireless network provider, such as T-Mobile, Voicestream, AT&T Wireless, etc. “IWS” is short for the Iowa Wireless Service carrier.
- **Registered on home network:**  
If the WAN radio module has registered with a service provider network, then one of the following will appear:
  - *Registered on home network:*  
The radio module is registered on its “home” network.
  - *Registered on roamed network:*  
The radio module is registered on another service provider’s network.
  - *Radio Not Registered:*  
There is no network within range of this radio module.
- **Radio ESN:**  
This displays the Electronic Serial Number (ESN) assigned to this radio module or lists “Unavailable” if a number cannot be read from the radio.

- **RSSI:**  
This displays the Received Signal Strength Indicator (RSSI) frequency or lists “Unavailable” if there is no signal or the signal cannot be retrieved from the radio module.
- **BER (*GSM/GPRS GEM 350X, CDMA/1xRTT*):**  
This shows the Bit Error Rate (BER), the percentage of bits with errors divided by the total number of bits transmitted, received, or processed over a given period of time.
- **f/w:**  
This identifies the firmware version, if available.
- **h/w:**  
This identifies the hardware version, if available.
- **Serial Status:**  
This indicates whether serial communications passed (“Serial com OK”) or failed (“Serial com FAIL”) in its last transaction. A status of “Serial com FAIL” typically indicates that the 700 Series Computer is unable to establish communication with the radio module installed within.
- **Xircom GEM3503 (*GSM/GPRS*), Siemens MC45 (*GSM/GPRS*), or Sierra Wireless SB555 (*CDMA/1xRTT*):**  
This identifies the product name for this radio module.
- **Band (*GSM/GPRS*) or Channel (*CDMA/1xRTT*):**  
This identifies the bandwidth or channel available for this radio module, if any.
- **History:**  
This bar graph displays an active history of this radio module’s quality of connections.
- **Friendly Indicator:**  
Usually indicates the signal strength for this radio module. Three filled dots indicate a high quality or strong signal. Three empty dots indicate that the signal is out of range or there is no signal detected.



## Details

Below are descriptions and meanings for each piece of information provided via the **Details** tab, reading from top to bottom. Most of this is similar to what is shown under the **General** tab. *The information applies to both the GSM/GPRS and the CDMA/1xRTT radio modules unless otherwise indicated.*



- Serial Status:**  
 This indicates whether serial communications passed (“PASS”) or failed (“FAIL”) in its last transaction. A status of “FAIL” typically indicates that the 700 Series Computer is unable to establish communication with the radio module installed within.
- Manufacturer:**  
 This lists the name of the manufacturer that developed this radio module, such as “Xircom, an Intel Corporation,” “Siemens,” or “Sierra Wireless.”
- Model:**  
 This identifies the product name for this radio module, such as “SB555,” “GEM350X,” or “MC45.”
- IMEI # (GSM/GPRS):**  
 This is the IMEI (International Mobile station Equipment Identity) serial number of the GSM/GPRS radio module.
- RSSI:**  
 This displays the RSSI frequency or lists “Unavailable” if there is no signal or the signal cannot be retrieved from the radio module.
- Operator:**  
 This lists the name of the service providing the network support.
- SIM Status (GSM/GPRS MC45):**  
 Identifies whether a Subscriber Identity Module (SIM) card is installed in this 700 Series Computer.

- **Band** (*CDMA/1xRTT*):  
This identifies the frequency bands used by this radio module.
- **IMSI #** (*GSM/GPRS*):  
This shows the IMSI (International Mobile Subscriber Identity) number assigned to the SIM card installed in this 700 Series Computer.
- **Radio Temp** (*CDMA/1xRTT*):  
This identifies the temperature of the radio module, or lists “Unavailable degrees” if there is no information or the temperature cannot be measured.
- **Firmware Rev:**  
This identifies the firmware version, if available.
- **Firmware Date** (*GSM/GPRS*):  
This provides the last date when this firmware was updated, if available.

### Terminal Application

Tap **Terminal App** from the **Details** page to send standard AT commands. Information about these AT commands are available under “*AT Command Interface*” on page 115.

Select an AT command from the drop-down list, then tap **Send**. The results of each test appears in the text box. Tap **Exit** or **ok** to close this screen and return to the **Details** page.

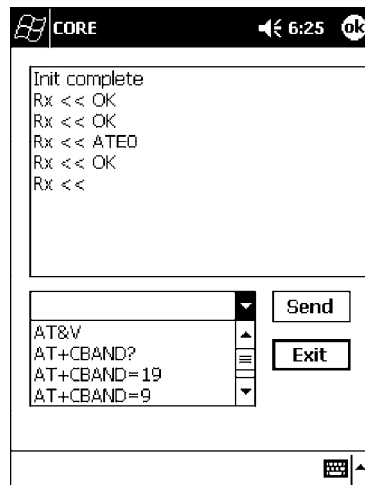

## Phone Application

With the WAN radio module installed in your 700 Series Computer, you can send and receive telephone calls. Use the speaker on the back of the computer as your earpiece and use the connector on the bottom of the computer for your mouthpiece.

Tap **Phone App** from the **Details** page to access the application which will process your phone calls. Tap **Exit** or **ok** to close this application and return to the **Details** page.

- Tap the numbers for a phone call, using **Clear** to erase each digit, then tap **Send** to initiate the call.
- Tap **Answer** to receive an incoming call.
- Tap **End** to disconnect a transaction.
- Tap **Vol ^** or **Vol v** to adjust the speaker volume.
- Tap **Mic ^** or **Mic v** to adjust the microphone sensitivity.

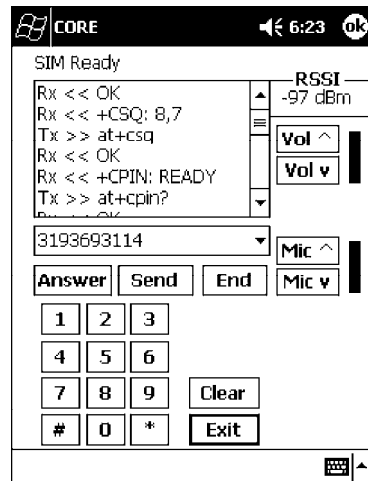

## AT Command Interface

This interface specification is based on the following recommendation:

- **ETSI GSM 07.05:**  
*European Digital Cellular Telecommunication System (phase 2)*  
Use of DTE-DCE interface for Short message and cell broadcast service.
- **ETSI GSM 07.07:**  
*European Digital Cellular Telecommunication System (phase 2)*  
AT command set for GSM Mobile Equipment.
- **ITU-T Recommendation V.25 ter**  
Serial asynchronous automatic dialing and control.



**Note:** You will need the Adobe Acrobat Reader application to view a PDF document. Go to “<http://www.adobe.com/prodindex/acrobat/readstep.html>” to install or download the latest Adobe Acrobat Reader according to Adobe’s instructions.

### **Command Set for Sierra Wireless SB555**

Use the AT command interface from Sierra Wireless to program the CDMA/1xRTT SB555 radio module. Documentation for this interface is available via the following URL. Click the “General AT command reference” link for a PDF document, which is 680 KB in size. *Note that this URL is subject to change.*

[http://www.sierrawireless.com/ProductsOrdering/embedded\\_docs.html](http://www.sierrawireless.com/ProductsOrdering/embedded_docs.html)

### **Command Set for Xircom/Intel GEM350X**

Use the GEM350X AT command list from Intel Corporation to program the GPRS/GSM GEM350X radio module. The “*GEM350X Programmer’s Reference*” is available either from Intermec Technologies or from Intel Corporation. Contact either your Intermec representative or the Intel Corporation support personnel at the following URL for more information. *Note that this URL is subject to change.*

<http://support.intel.com/sites/support/index.htm?iid=intelhome1+support&>

### **Command Set for Siemens MC45**

Use the MC45 AT command interface from Siemens AG to program the GPRS/GSM MC45 radio module. The “*MC45 Siemens Cellular Engine AT Command Set*” is available either from Intermec Technologies or from Siemens AG. Contact either your Intermec representative or the Siemens AG support personnel at the following URL for more information. *Note that this URL is subject to change.*

[http://www.siemens-mobile.com/btob/CDA/presentation/ap\\_btob\\_cda\\_presentation\\_fromtdoor/0,2950,12,FF.html](http://www.siemens-mobile.com/btob/CDA/presentation/ap_btob_cda_presentation_fromtdoor/0,2950,12,FF.html)



### Testing the AT Commands

These commands can be sent to either WAN radio by setting up a dial-up networking connection to COM4. Do the following to initiate this connection and test these commands to your radio:



- 1 From the 700 Series Computer, select **Start** → **Settings** → the **Connections** tab → the **Connections** icon.
- 2 Tap **Modify** beneath the **Internet Settings** drop-down list.

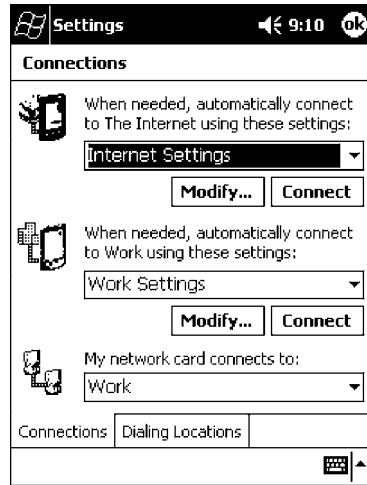

- 3 Tap **New..** to make a new connection.

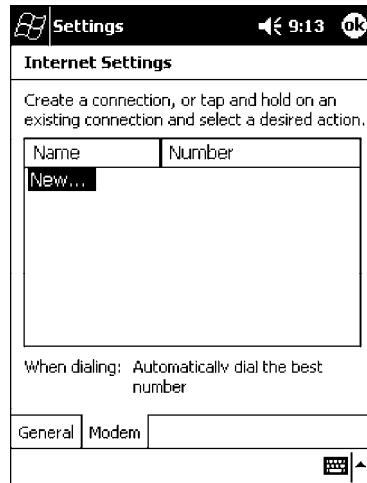

- 4 Enter a name for the connection, select “WAN on COM4” from the **Select a modem** drop-down list, and select “115200” from the **Baud rate** drop-down list. Tap **Advanced** to continue.

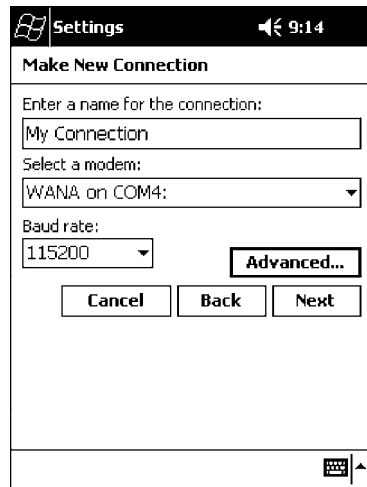

- 5 On the **Port Settings** tab, check **Enter dialing commands manually**, then tap **ok**, **Next**, then **Finish** to return to the Internet Settings screen with your new connection.

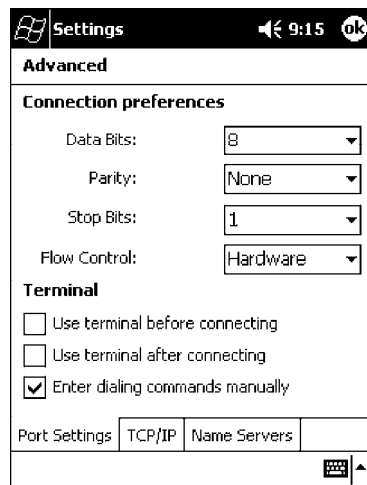

- 6 Press and hold the new connection for a pop-up menu, then tap **Connect** to initiate the connection. Wait for about ten seconds for the Network Log On screen, then tap **OK**. *Note: You do not need to enter any information within the Network Log On screen.*

- 7 Use either the onscreen keyboard, or press the keys to type any of the AT commands provided by Sierra Wireless. Press or tap **Enter** to send each command. The results of each command sent will print onscreen - see the sample illustration below. *Note that each “AT” command must start with either the “at” or “at+” characters.*
- To see what you typed onscreen, type “ate1” to initiate the AT Echo command, then press **Enter**.

## Wireless Printing

The 700 Series Computer can integrate the Wireless Printing option (*which is equipped with a Bluetooth qualified module by Socket Communications*) along with either the GSM/GPRS or the CDMA/1xRTT radio and the 802.11b radio. This option uses the network to print information stored on the 700 Series Computer.

“Bluetooth” is the name given to a technology standard using short-range radio links, intended to replace the cables connecting portable and fixed electronic devices. The standard defines a uniform structure for a wide range of devices to communicate with each other, with minimal user effort. Its key features are robustness, low complexity, low power, and low cost. The technology also offers wireless access to LANs, the mobile phone network, and the internet for a host of home appliances and portable hand-held interfaces.

### Documentation

Information about additional “Bluetooth” software, including the Bluetooth Device Manager and the BTctrl program, can be found within the Wireless Printing SDK. This is located on the 700C Software Tools CD, via the directory off the root of the toolkit called “*Wireless Printing SDK*.” It also can be found in the *Wireless Printing Development Guide*, also on the 700C Tools CD.

### Bluealps CORE Module

The Bluealps CORE module displays helpful information about this Wireless Printing option within your 700 Series Computer. Below are descriptions and meanings for each piece of information provided via the **General** tab, reading from top to bottom starting on the left.

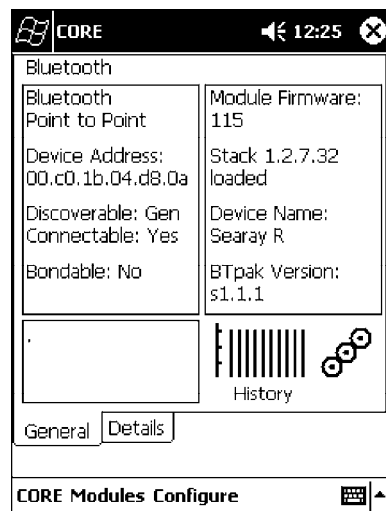

- **Bluetooth Point to Point:**  
This is the network type. “Point to Point” is the type of connection supported as of this publication. *Scatternets are not supported.* The only supported application is wireless printing to Intermec wireless printers, such as the 781T Belt-Mount Printer.
- **Device Address:**  
This provides the network address, which in this case, will be replaced by the device address of the Bluetooth compatible module within your 700 Series Computer. *Note that this address is universally unique.*
- **Discoverable:**  
The following is displayed depending on whether the 700 Series Computer is configured to be discoverable:
  - “Gen” Generally discoverable
  - “Lim” Limited discovery
  - “No” Not discoverable
- **Connectable:**  
This defines whether the 700 Series Computer is able to accept other devices with Bluetooth compatible modules connecting to it. “Yes” if the connection is doable, “No” if not.
- **Bondable:**  
This defines the security element of the 700 Series Computer, which is the bondable setting. If the unit is bondable, then “Yes” is displayed, otherwise “No” is displayed.
- **Module Firmware:**  
This reflects the firmware (hardware) version of the 700 Series Computer. When the CORE module first installs onto the unit, the firmware level is unknown, thus “...reading” is displayed. Once the firmware level is read from the unit, then a three-digit decimal is displayed.
- **Stack [Stack Version] [loaded/not loaded]:**  
[Stack Version] displays the Bluetooth stack version, which appears in the “1.2.3.4” format. If the stack is loaded, then “loaded” is displayed after the stack version, otherwise “not loaded” is displayed.
- **Device Name:**  
This displays the device name as assigned to the Bluetooth compatible module by the end-user. If the configured name is longer than the space allowed, it will be truncated.
- **BTpak Version:**  
This displays the driver version of additional Bluetooth components within the 700 Series Computer and is usually presented in the “1.2.3” format. The version may also contain a letter at either end.
- **History:**  
This bar graph displays an active history of this wireless printer driver’s quality of connections.
- **Friendly Indicator:**  
If the Bluetooth stack is loaded, then all three dots are filled. These dots are left empty if the stack is not loaded. These dots do vary based on the CORE application’s perception of the overall connection quality.



## AutoIP/DHCP

Automatic Private IP Addressing (AutoIP) is enabled by default in Pocket PC 2002. To remain compatible with other Pocket PC devices, this setting needs to be enabled. You can configure the registry settings in the following to set the required AutoIP/DHCP behavior:

- For Ethernet: HKEY\_LOCAL\_MACHINE\Comm\LAN9001\TcpIp
- For 802.11b: HKEY\_LOCAL\_MACHINE\Comm\NETWLAN1\TcpIp

Other registry keys that can modify the behavior of AutoIP are as follows. You can find the appropriate settings and behavior of each of these keys in Microsoft Help.

- AutoInterval
- AutoMask
- AutoSubnet
- AutoIP
- AutoSeed

When a TCP/IP client cannot find a DHCP server, it generates an AutoIP address from the 169.254.xxx.xxx block. The client then tries to check for a DHCP server every 300 seconds (5 minutes) and if a DHCP server is found, the client drops the AutoIP address and uses the address from the DHCP server.

In the MSDN Windows CE documentation, see “*Automatic Client Configuration*” for more information on AutoIP.

To disable AutoIP, set the AutoCfg registry entry to “0.” If a DHCP server cannot be found, instead of using AutoIP, the system will display the “Unable to obtain a server assigned IP address” message.



**Note:** If AutoIP is defined using CAB files, the EnableDHCP registry key must also be defined and set to “1” before the system will attempt to obtain a DHCP address.

To extend the number of attempts that a DHCP client makes to get a DHCP address, use the DhcpRetryDialogue and DhcpMaxRetry registry settings.

Change the AutoInterval registry key value to make the client retry more often to obtain a DHCP address.

## SNMP Configuration

Simple Network Management Protocol (SNMP) was developed in the late 1980s to provide a general-purpose internetworking management protocol. Its primary goal was to be simple so nothing would stand in the way of its ubiquitous deployment. To this end, it has been very successful as it is currently deployed in almost every major internetworking product on the market. However, like many achieved goals, the primary strength can also become a weakness.

### The Focus was “Simple”

An extreme example of simplicity versus power can be realized by comparing SNMP against the Common Management Information Protocol (CMIP), the ISO entry to the standard management protocol world. CMIP has a very rich set of primitives and a core set of data elements. However, to implement CMIP, a subset of the protocol must be selected. Then, to achieve interoperability, this subset must be agreed upon with other implementors. As SNMP was specified completely and with no options, one implemented what was there and interoperability was assured. Returning to simplicity, SNMP was built simply for a number of reasons other than time to market: robustness in the face of network failure, low overhead in the devices running the protocol; and ease of debugging the protocol itself (*the last thing you want to debug is the management protocol that is supposed to be helping you debug your network*). Thus, the SNMP limited itself to the User Datagram Protocol (UDP). This gave the implementor the ability and responsibility to manage lost packets and perform any necessary retransmissions. As network debugging in the face of changing routes will certainly mean losing packets, retaining this control from the transport service (*layer 4*) was considered essential. Since a network management protocol will run continuously, it is mandatory that it consume as minimal a network resource as possible. UDP allows the necessary control over packet transmissions, packet size and content (*packetization*). It is a natural choice.

### Using SNMP

SNMP has three control primitives that initiate data flow from the requester (*get, get-next, and set*). There are two control primitives the responder uses to reply. One is used in response to the requester's direct query (*get-response*) and the other is an asynchronous response to obtain the requester's attention (*trap*). All five of these primitives are carried by UDP and are thus limited in size by the amount of data that can fit into a single UDP packet. The relatively small message size was a goal of the design but for some reasonable set of network management functions, it imposes a limitation.

Often in network management, it is necessary to obtain bulk information without knowing at first what is in that bulk. In one case, there is a set of problems having to do with packets not going where they are supposed to, due to device misconfiguration that prevents proper protocol operation where one needs to view the entire set of data.

## Retrieval of Management Information

SNMP has the get-next primitive which permits the viewing of data without requiring prior knowledge. If you know what you are looking for, the get primitive will return it. When you want an entire table of information, the get-next primitive will obtain it. However, unless employed with care, the get-next primitive can be extremely resource-intensive in real time, network bandwidth, and the agent's CPU time. The simplest use of the get-next primitive is to start at the beginning of a table, await the response and then issue another get-next with the name returned. As an example, say you wanted the next-hop address, next-hop interface, and route-type from a routing table containing 1000 entries. Using the simplest form of get-next, this would require  $2 \times 3 \times 1000$  or 6000 packets (*get-next and get-response packets, columns, and rows*). A straight-forward optimization would be to request the three columns in a single packet. This puts the number of packets at  $2 \times 1000$  or 2000 packets. In real time, it is the product of the round trip by the number of request. In agent CPU time, this is still 6000 lookups in the routing table for both cases.

## An Early Approach to Getting More than One Item at a Time

The ability to retrieve only one piece or object at a time has been a problem for SNMP. This is particularly an issue with the use of this protocol in wireless environments where the wireless datapipe is small and overhead due to network management it is considered overhead. One approach creates multiple get-next requests running concurrently. A second algorithm, reduces the packet count by combining the multiple concurrent get-nests into a single packet. Neither approach has been implemented which makes network management in wireless environment, though essential to the success of the operation, tenuous. The issue has been resolved in SNMP V2 protocol where a get-bulk primitive has been defined.

## Conclusion

Software development moves forward by evolving the unknown into the known and wireless environments are moving from vertical only application to wide spread implementation. At the time of the SNMP inception, it was not possible to conceive of a reliable transport based network management protocol. Today's problems require more sophisticated data to analyze a problem. This puts the burden back on the protocol to send and receive data quickly and efficiently. Work continues in subcommittees to improve SNMP and resolve the issues that are developing with new applications and new network architectures.



## SNMP Configuration on the 700 Series Computer

In short, SNMP is an application-layer protocol that facilitates the exchange of management information between network devices. The 700 Series Computer is such an SNMP-enabled device. Use SNMP to control and configure the 700 Series Computer anywhere on an SNMP-enabled network.

The 700 Series Computer supports four proprietary Management Information Bases (MIBs) and Intermec Technologies provides SNMP support for MIB-II through seven read-only MIB-II (RFC1213-MIB) Object Identifiers (OIDs).



**Note:** You can only query these seven OIDs through an SNMP management station, these are not available in the Unit Manager applications.

### Management Information Base

The Management Information Base is a database that contains information about the elements to be managed. The information identifies the management element and specifies its type and access mode (Read-Only, Read-Write). MIBs are written in ASN.1 (Abstract Syntax Notation.1) - a machine independent data definition language. *Note: Elements to be managed are represented by objects. The MIB is a structured collection of such objects.*

You will find the following MIB files either on the 700C Tools CD or on the web via <http://www.intermec.com>:

- **INTERMEC.MIB**  
Defines the root of the Intermec MIB tree.
- **ITCADC.MIB**  
Defines objects for Automated Data Collection (ADC), such as bar code symbologies.
- **ITCSNMP.MIB**  
Defines objects for Intermec SNMP parameters and security methods, such as an SNMP security IP address.
- **ITCTERMINAL.MIB**  
Defines objects for 700 Series parameters, such as key clicks.

## Object Identifiers

Each object has a unique identifier called an OID. OIDs consist of a sequence of integer values represented in dot notation. Objects are stored in a tree structure. OIDs are assigned based on the position of the object in the tree. Seven MIB OIDs are shown in the following table.

### Example

The internet OID = 1.3.6.1.

### MIB Object Identifiers

MIB-II Item	OID	Group or Table	Description
ifNumber	1.3.6.1.2.1.2.1.0	Interfaces Group	Indicates the number of adapters present in the system. For the 700 Series Computer, if one adapter is present in the system, then <i>ifNumber</i> = 1 and <i>ifIndex</i> = 1.
ifIndex	1.3.6.1.2.1.2.2.1.1.ifIndex	Interfaces Table (ifTable)	A unique value for each interface. The value ranges between 1 and the value of <i>ifNumber</i> .
ifDescr	1.3.6.1.2.1.2.2.1.2.ifIndex	Interfaces Table (ifTable)	A textual string containing information about the interface.
ifType	1.3.6.1.2.1.2.2.1.3.ifIndex	Interfaces Table (ifTable)	An integer containing information about the type of the interface. It is equal to 1 for Other.
ipAdEntAddr	1.3.6.1.2.1.4.20.1.1.IpAddress	IP address Table (ipAddrTable)	The IP address to which this entry's addressing information pertains ( <i>same as 700 IP address</i> ), where IP Address is the valid non-zero IP address of the 700 Series Computer.
ipAdEntIfIndex	1.3.6.1.2.1.4.20.1.2.IpAddress	IP address Table (ipAddrTable)	The index value that uniquely identifies the interface to which this entry is applicable ( <i>same as ifIndex</i> ).
ipAdEntNetMask	1.3.6.1.2.1.4.20.1.3.IpAddress	IP address Table (ipAddrTable)	The subnet mask associated with the IP address of this entry ( <i>same as Subnet Mask</i> ).

## Configuring with SNMP

The community string allows an SNMP manager to manage the 700 Series Computer with a specified privilege level. The default read-only community string is “public” and “private” is the default read/write community string. See the specific configuration parameter to find its OID. To configure the 700 Series Computers using SNMP:

- 1 Configure 700 Series Computers for RF or Ethernet communications.
- 2 Determine the OID (Object Identifier) for the parameter to be changed. The Intermec base OID is 1.3.6.1.4.1.1963.
- 3 Use your SNMP management station to get and set variables that are defined in the Intermec MIBs. You can set the traps, identification, or security configuration parameters for SNMP. See *Appendix A, “Control Panel Applets,”* to learn more about these parameters.



# 5 Printer Support

The 700 Series Color Mobile Computer works with the following printers from Intermec Technologies. Contact an Intermec Representative for information about these printers.

- **6820**  
A full-page, 80-column printer.
- **6808**  
A 4-inch belt-mount printer.
- **781T**  
A 2-inch belt-mount printer with a Bluetooth compatible module from Socket Communications.
- **782T**  
A 2-inch workboard printer.

## Printing ASCII

The following methods for printing using Pocket PC at this time is as follows:

- Add port drivers to print ASCII directly to the port.
- Use LinePrinter ActiveX Control from the Software Developer's Kit (SDK) - *see the SDK User's Manual for more information.*
- Via wireless printing - *see the Wireless Printing Development Guide on the 700C Software Tools CD for more information.*

### Directly to a Port

Printing directly to the port sends RAW data to the printer. The format of this data depends upon your application and the printer capabilities.

You must understand the printer commands available for your specific printer. Generally, applications just send raw ASCII text to the printer. Since you are sending data to the printer from your application directly to the port you are in complete control of the printers operations. This allows you to do line printing (*print one line at a time*) rather than the page format printing offered by the GDI approach. It is also much faster since data does not have to be converted from one graphics format to the other (display to printer). Most Intermec<sup>®</sup> printers use Epson Escape Sequences to control print format operations.

These commands are available in documentation you receive with your printers or from technical support. Win32 APIs are required to print directly to the port.

### Directly to a Generic Serial Port

To print directly to a generic serial port printer (non-Intermec printers):

- Use CreateFile() to open ports - COM1: can be opened on most devices.
- Use WriteFile() to send data directly to the printer.
- Use CloseHandle() when you are finished printing to close the port.

## IrDA Printer Driver

IrDA printing is only available on the certain devices and is supported directly by the Windows CE load via the IrSock API provided by the Microsoft Win32 API without need for additional drivers. Intermec 6804, 6805, 6806, 6808 and 6820 and other IrDA printers are supported.

## NPCP Printer Driver

The NPCP printer communications driver (NPCPPORT.DLL) is a Stream Device Driver built into the operating system. The driver supports only NPCP communications to and from the 6820 and 4820 printers over a selected serial port.

All applications use WIN32 API functions to access the drivers. Basic operations are easily implemented by applications through the CreateFile(), WriteFile(), ReadFile(), DeviceIOControl(), and CloseHandle() Win32 APIs.

Operations to upgrade printer modules, perform printer diagnostics, and get printer configuration are performed largely via DeviceIOControl() functions.

### About NPCP

NPCP (Norand<sup>®</sup> Portable Communications Protocol) is a proprietary protocol that provides session, network, and datalink services for Intermecc mobile computers in the Intermecc LAN environment used with printers and data communications.

### NPCP Driver Installation and Removal

Use LPT9: for the NPCP printer device and COM1 for the last parameter. COM1 is the connection available via the 700 Series Computer.

Applications use the RegisterDevice() function to install the driver. DeregisterDevice() uninstalls the device driver and frees memory space when the driver is not required. Use the HANDLE returned by RegisterDevice() as the parameter to DeregisterDevice().

Use the RegisterDevice() function call as demonstrated below. Specify the full path name to the driver starting at the root for the RegisterDevice() function to work properly. The last parameter to RegisterDevice() is a DWORD that represents the name of the port for the NPCP stream driver to use. Build this parameter on the stack if it is not to be paged out during the call. The first parameter "LPT" (Device Name) and the second parameter "9" (index), indicate the name of the registered device, such as LPT9. This is used in the CreateFile() function call.

```
Install()
{
    HANDLE hDevice;
    TCHAR port[6];
    port[0] = TCHAR('C');
    port[1] = TCHAR('O');
    port[2] = TCHAR('M');
    port[3] = TCHAR('1');
    port[4] = TCHAR(':');
    port[5] = TCHAR(0);
    hDevice = RegisterDevice ( (TEXT("LPT"), 9,
    TEXT("\\STORAGE CARD\\WINDOWS\\NPCPPORT.dll"), (DWORD)port);
}
```

## Opening the NPCP Driver

The application opens the NPCP driver by using the `CreateFile()` function. The call can be implemented as follows. The first parameter “LPT9:” must reflect the device name and index used in the `RegisterDevice()` function call and will fail for any of the following reasons:

```
hFile = CreateFile(_T("LPT9:"), GENERIC_WRITE |  
GENERIC_READ, 0, NULL, OPEN_ALWAYS, FILE_ATTRIBUTE_NORMAL,  
NULL);
```

- The port associated with the device during `RegisterDevice()` is in use.
- The NPCP device is already open.
- The share mode is not set to zero. The device cannot be shared.
- Access permissions are not set to `GENERIC_WRITE | GENERIC_READ`. Both modes must be specified.

## Closing the NPCP Driver

Using the `CloseHandle()` (`hFile`) function closes the NPCP driver. Where *hFile* is the handle returned by the `CreateFile()` function call.

- TRUE = the device is successfully closed.
- FALSE = an attempt to close NULL HANDLE or an already closed device.

## Reading from the NPCP Driver

Reading of the NPCP printers is not supported since all responses from the printer are the result of commands sent to the printer. `DeviceIoControl()` functions are provided where data is to be received from the printer.

## Writing to the NPCP Driver

All Print data can be sent to the printer using the `WriteFile()` function. The print data written to the driver must contain the proper printer commands for formatting. If the function returns FALSE, the NPCP error may be retrieved using `IOCTL_NPCP_ERROR`. See the description on the next page.

## NPCP Driver I/O Controls

An application uses the DeviceIoControl() function to specify a printer operation to be performed. Certain I/O controls are required to bind and close communication sessions with the printer, and must be completed before any other commands to the driver can execute properly.

The function returns TRUE to indicate the device successfully completed its specified I/O control operation, otherwise it returns FALSE. The following I/O control codes are defined:

```
#define IOCTL_NPCP_CANCEL
CTL_CODE(FILE_DEVICE_SERIAL_PORT,0x400,METHOD_BUFFERED,FILE_ANY_ACCESS)
#define IOCTL_NPCP_BIND
CTL_CODE(FILE_DEVICE_SERIAL_PORT,0x401,METHOD_BUFFERED,FILE_ANY_ACCESS)
#define IOCTL_NPCP_CLOSE
CTL_CODE(FILE_DEVICE_SERIAL_PORT,0x402,METHOD_BUFFERED,FILE_ANY_ACCESS)
#define IOCTL_NPCP_ERROR
CTL_CODE(FILE_DEVICE_SERIAL_PORT,0x403,METHOD_BUFFERED,FILE_ANY_ACCESS)
#define IOCTL_NPCP_FLUSH
CTL_CODE(FILE_DEVICE_SERIAL_PORT,0x404,METHOD_BUFFERED,FILE_ANY_ACCESS)
#define IOCTL_NPCP_IOCTL
CTL_CODE(FILE_DEVICE_SERIAL_PORT,0x405,METHOD_BUFFERED,FILE_ANY_ACCESS)
#define IOCTL_NPCP_PRTVER
CTL_CODE(FILE_DEVICE_SERIAL_PORT,0x406,METHOD_BUFFERED,FILE_ANY_ACCESS)
```

- **IOCTL\_NPCP\_CANCEL**  
This cancels all printing at the printer. It flushes the printer buffers and reinitializes the printer to its default state. No parameters are required.
- **IOCTL\_NPCP\_BIND**  
This command is required before any data is sent or received by the printer. Once the driver is opened, the application must bind the communications session with the printer before any data can be sent or received by the printer. If an error occurs during the bind, the application may use IOCTL\_NPCP\_ERROR to get the current extended error code. No parameters are required.
- **IOCTL\_NPCP\_CLOSE**  
This command closes the current session with the printer. This function always returns TRUE. No parameters are required.
- **IOCTL\_NPCP\_ERROR**  
This command returns the extended NPCP error code in PL/N format. The word returned will contain the PL/N compatible error code in the low byte and completion flags in the high byte. If the frame that returned an error was not received correctly by the printer the FRAME\_NOT\_ACKED bit will be set in the high byte. This operation always returns TRUE. An output buffer of at least 2 bytes is required. See “NPCP Error Codes” on page 133.
- **IOCTL\_NPCP\_FLUSH**  
This command allows the application to poll the printer for errors while the report is completing the print process at the printer. If an error occurs during the polling process, the operation will return FALSE and the application can get the extended error code by using IOCTL\_NPCP\_ERROR. No parameters are required.

## NPCP Printer Communications

All NPCP printer communications should be based on the following flow:

- 1 Use `CreateFile()`; to open the printer driver.
- 2 Use `IOCTL_NPCP_BIND` to bind a session with the printer; `IOCTL_NPCP_ERROR` to check for errors on the bind to ensure success; and `IOCTL_NPCP_CANCEL` to cancel any outstanding print jobs.
- 3 Use `IOCTL_NPCP_FLUSH` to poll the printer to free up printer buffer resources. Use `IOCTL_NPCP_FLUSH` to poll the printer's status. If an error is reported by the `IOCTL`, then use `IOCTL_NPCP_ERROR` to get the error and determine the correct recovery procedure.
- 4 Use `WriteFile()`; to write your data to the printer. Check for errors and that all data were written. Use `IOCTL_NPCP_ERROR` to get the extended error. If the error is critical in nature, use `IOCTL_NPCP_CLOSE`, followed by `CloseFile()`, to end the communications session. Start a new session, beginning with step 1 to ensure proper printing. For noncritical errors display the error and retry the operation.
- 5 After all data is sent to the printer, ensure that the printer continues to print the report properly by polling the printer's status. Use `IOCTL_NPCP_FLUSH` to poll the printer's status. If an error is reported by the `IOCTL`, then use `IOCTL_NPCP_ERROR` to get the error and determine the correct recovery procedure.

## Sample Code

See sample code in the “\700 Color Dev Tools\Installable Drivers\Port Drivers\Npcp\NPCPPrint\” directory for more details on printing, printer communications and error code handling.



## NPCP Error Codes

Call the `IOCTL_NPCP_ERROR` I/O control function to receive PL/N compatible error codes. Applications must decide how to act upon the data returned.

```
// Definition of NPCP communications Errors and Printer Errors
#define PNRDY (BYTE)102 // link not ready error
#define RXTMO (BYTE)104 // link no receive error
#define TXTMO (BYTE)106 // link no transmit error
#define BADADR (BYTE)111 // frame address error
#define GAPERR (BYTE)112 // link gap error (timeout) in receive data
#define LSRPE (BYTE)113 // frame parity error on length field
#define IFTS (BYTE)120 // session layer - invalid frame this state
#define NS_NE_VR (BYTE)121 // session layer sequence error
#define NR_NE_VS (BYTE)122 // session layer sequence error
#define MAC_CRCERR (BYTE)124 // MAC CRC error
#define RLENERR (BYTE)123 // MAC too much data received
#define FRMERR (BYTE)200 // Frame Reject
#define FRMERR_IF (BYTE)201 // Frame Reject - Invalid Frame
#define FRMERR_NR (BYTE)202 // Frame Reject - NR Mismatch
#define FRMERR_NS (BYTE)203 // Frame Reject - NS Mismatch
#define NDMERR (BYTE)204 // Normal Disconnect mode error
#define BINDERR (BYTE)210 // bind error
#define IPLDUR (BYTE)221 // invalid presentation layer response
#define HEADJAM (BYTE)222 // printer head jam
#define PAPEROUT (BYTE)223 // printer paper out
#define LOWVOLTS (BYTE)224 // printer low voltage
#define HIVOLTS (BYTE)225 // printer over voltage
#define LOWBAT (BYTE)226 // printer low battery
#define COVEROFF (BYTE)227 // printer cover off error
#define HEADFAULT (BYTE)228 // printer head short or driver short error
#define PFFAULT (BYTE)229 // paper feed motor fault.
#define FRAME_NOT_ACKED 0x8000 // frame was not received by printer and need to
be resent.
```

## O'Neil Printer Driver

The DTR printer communications driver is a Stream Device Driver named ONEIL.DLL.

All applications use WIN32 API functions to access drivers. Basic operations are easily implemented by applications through the CreateFile(), WriteFile(), DeviceIOControl() and CloseHandle() Win32 APIs.

The driver supports communications to 6804DM, 6804T, 6805A, 6806, 6808, 681T, and 781 printers over a selected serial port.

### DTR Driver Installation and Removal

Your application must install the device driver by using the RegisterDevice() function. The driver name is ONEIL.DLL. We recommend that you use “DTR” for the Device Name parameter, “1” for the Device Driver index parameter, and use any of the following strings for the last parameter:

- NULL (==0) Defaults to COM1 @ 9600
- “COM1” only COM port specified defaults to 9600
- “COM1:9600” sets to COM port and specified bit rate
- “COM1:19200” sets to COM port and specified bit rate

Use the HANDLE returned by RegisterDevice() as the parameter to DeregisterDevice(). The correct usage of the RegisterDevice() function call is demonstrated below. You may use DeregisterDevice() to uninstall the driver.

```
Install()  
{  
  
    HANDLE hDevice;  
    TCHAR port[6];  
    port[0] = TCHAR('C');  
    port[1] = TCHAR('O');  
    port[2] = TCHAR('M');  
    port[3] = TCHAR('1');  
    port[4] = TCHAR(':');  
    port[5] = TCHAR(0);  
    hDevice = RegisterDevice ( (TEXT("DTR"), 1, TEXT("\\WINDOWS\\ONEIL.DLL"),  
        (DWORD)port);  
  
}
```

## Opening the DTR Driver

The application opens the DTR driver by using the `CreateFile()` function. The call can be implemented as follows:

```
hFile = CreateFile(_T("DTR1:"), GENERIC_WRITE, 0, NULL,
OPEN_ALWAYS, FILE_ATTRIBUTE_NORMAL, NULL);
```

The first parameter “DTR1:” must reflect the device name and index used in the `RegisterDevice()` function call.

The function call will fail for any of the following reasons:

- The port associated with the device during `RegisterDevice()` is currently in use.
- The DTR device is already open.
- The share mode is not set to zero. The device cannot be shared.
- Access permissions are not set to `GENERIC_WRITE`.

## Closing the DTR Driver

Using the `CloseHandle()` (`hFile`) function closes the DTR driver. Where *hFile* is the handle returned by the `CreateFile()` function call.

- `TRUE` indicates the device is successfully closed.
- `FALSE` indicates an attempt to close a `NULL HANDLE` or an already closed device.

## Writing to the DTR Driver

You can use the `WriteFile()` function to send all Print data to the printer. The print data being written must contain the proper formatting printer commands.

## DTR Printer Communications

All DTR printer communications should be based on the following flow:

- 1 Use `CreateFile()`; to open the printer driver.
- 2 Use `WriteFile()` to write your data to the printer. Check for errors and that all data were written.
- 3 Use `CloseHandle()` to close the driver.





# 6 Scanner Support

The 700 Series Color Mobile Computer is available with imaging or laser scanning technologies, including the following:

- **APS linear imager:**  
Reads 1D symbologies and PDF 417 bar codes. Linear imaging using Vista Scanning technology reads low-contrast bar codes, laminated bar codes, and bar codes displayed on CRT or TRT displays. This imaging uses harmless LEDs for illumination and does not require any warning labels. Vista Scanning is more reliable than lasers as it is a completely solid state with no moving parts or oscillating mirrors.
- **2D Imager:**  
This decodes several stacked 1D and 2D symbologies, including PDF 417 and Data Matrix without “painting.” It can also read 1D codes from any orientation, for example the scan beam does not need to be aligned perpendicular to the symbol in order to read it. Photography is a secondary application; the lens in the device will favor bar code reading. Photos are 640x480, 256 gray-scale.
- **1D laser scanner:**  
Traditional laser scanner that decodes 1D bar codes.
- **PDF 417 laser scanner:**  
Higher speed laser scanner that can read PDF 417 labels by “painting” the label.

## Scanner Control and Data Transfer



**Note:** To use the methods described below, enable Data Collection functionality on the 700 Computer using the bootloader configuration menu. See Chapter 3, “*Installing Applications*” for more information.

The Data Server and associated software provide several ways to manipulate scanner control and data transfer between the scanner subsystem and user applications:

- **Automatic Data Collection COM Interfaces:**  
These COM interfaces allow user applications to receive bar code data, and configure and control the bar code reader engine.
- **ITCaxBarcodeReaderControl functions:**  
These ActiveX controls allow user applications to collect bar code data from the scanner, to configure the scanner, and to configure audio and visual notification when data arrives. For more information, see the *SDK User's Manual*.
- **ITCaxReaderCommand functions:**  
Use these ActiveX controls to modify and retrieve configuration information using the reader interface commands. For more information, see the *SDK User's Manual*.
- **Scanning EasySet bar code labels:**  
You can use the EasySet bar code creation software from Intermec Technologies Corporation to print configuration labels. Scan the labels to change the scanner configuration and data transfer settings.

### Automatic Data Collection COM Interfaces

Data collection configuration and functionality cannot be accessed by any means (*including control panel applets or remote management applications*) until after the 700 Series Computer has completed initialization, which occurs during a warm- or cold-boot or after a firmware upgrade.

When initialization is complete, the green LED on the 700 Series Computer stops flashing. Changes made to configuration settings remain after a warm boot. After a cold-boot, all configuration settings are reset to their defaults with the exception of scanner configurations, which remain except for the Symbology Identifier transmission option or the Preamble and Postamble strings. To reset all configuration settings to the factory defaults, the S9C scanner firmware must be reloaded.

The Automatic Data Collection (ADC) functions are accessed through custom COM interfaces. These interfaces allow the application to receive bar code data and configure and control the bar code reader engine. The COM interfaces include the following functions:

- IADC (*starting on page 151*)
- IBarcodeReaderControl (*starting on page 159*)
- IS9CConfig (*starting on page 172*)
- IS9CConfig2 (*starting on page 204*)
- IS9CConfig3 (*starting on page 216*)
- IImage Interface (*starting on page 221*)

## Multiple ADC COM Object Support

A 700 Series Computer may have multiple reader engines to decode different types of ADC data. For example, a bar code reader engine decodes raw bar code data and passes it to a bar code reader COM object. An RFID reader engine decodes raw RFID tag data and passes it to an RFID tag reader COM object.

ADC COM interfaces are implemented as in-process COM objects. An instance of the ADC COM object creates a logical connection to access or control the reader engine. Specifically, the IBarcodeReadConfig or IBarcodeReaderControl COM objects can manage the bar code scanner configuration while the ADC COM object can gather data simultaneously. These ADC COM objects or connections can be created in a single application or multiple applications. Up to seven instances of a COM object can be created for a reader engine. For more information, see “*How to Create and Use the ADC COM Interfaces*” below.

For data collection features, ADC COM objects also provide for read ahead and non-read ahead data access and grid data editing.

## How to Create and Use the ADC COM Interfaces

You can also use the Input Device Functions (*starting on page 149*) to create and use the ADC COM interfaces.

- 1 Create and initialize the in-process Bar Code Reader object using `ITCDeviceOpen()` (*see page 149*). This function returns a COM Interface pointer to the Bar Code Reader Object created by the function.
- 2 Set the data grid if data filtering is desired (*default grid gives the application all the data*). Below is a sample code of how to set the grid to accept Code 39 data that starts with the letter “A” and is not a reader command.

```
ITC_BARCODEREADER_GRID stBCGrid;
stBCGrid.stDIGrid.szDataMask = TEXT("A%s");
stBCGrid.stDDGrid.dwSymbologyMask = BARCODE_SYMBOLGY_CODE39;
stBCGrid.dwDataSourceTypeMask = ITC_DATASOURCE_USERINPUT;
HRESULT hrStatus = pIBCCControl->SetAttribute(
ITC_RDRATTR_GRID,
reinterpret_cast<BYTE *>(&stBCGrid),
sizeof(stBCGrid)
);
```

- 3 Issue a read to accept the bar code data. The timestamp, symbology, and data type are put into the `ITC_BARCODE_DATA_DETAILS` structure. Passing in a pointer to this structure is optional. The following sample code uses an infinite timeout.

```
ITC_BARCODE_DATA_DETAILS stBCDetails;
BYTE rgbBCData[1024]; // Buffer used to accept the bar code data
DWORD dwBytesReceived; // Number of bytes in the return data.
HRESULT hrStatus = pIBCCControl->Read(
rgbBCData,
sizeof(rgbBCData),
&dwBytesReceived,
& stBCDetails,
INFINITE
);
```

- 4 Compile and link the application.

### Read-Ahead Bar Code Data Access

The Bar Code Reader COM object delivers ADC data to the connection in read-ahead mode. In this mode, the data is queued until a COM connection is ready to read it. Read-ahead mode decouples reader device performance from the application performance. That is, data is read as fast as the user can scan it, independent of the connection processing load. No data will be scanned until the first `Read()` function is posted.



## Grid Data Filtering

The virtual wedge retrieves scanned Automatic Data Collection (ADC) data and sends it to the keypad driver so that the 700 Series Computer can receive and interpret the data as keypad input. The data can be filtered so that only data conforming to a certain text pattern or symbology will be sent to an application. After the data is filtered, it can be edited by adding, deleting, or rearranging portions of the text or by extracting portions of text for further editing. To filter and edit data, you need to define the virtual wedge grid parameters.

- **Grid Processing:**

Grid processing takes place in two steps:

- **Compilation:**

In which the user's grid expressions are checked for errors and reduced to a binary form for faster matching. This is done whenever the virtual wedge grid is set or changed by configuration software.

- **Matching:**

In which data is tested against the grids set in compilation. Matching can be performed multiple times after a compilation. The AIM symbology ID of the data being tested, including the enclosing angle brackets, must be prepended to the incoming data.

## Syntax

The basic syntax of each grid expression is:

```
<symID> filter-expression= > editing-expression
```

where:

- **symID**

Is the AIM symbology ID (*see the AIM Symbology ID Defaults table starting on page 219*).

- **filterexpression**

Is any character string that includes valid filter expression values (*see the "Filter Expression Values" table on the next page*).

- **editing-expression**

Is any character string that includes valid editing expression values (*see the "Editing Expression Values" table on page 144*).

## Filter Expression Values

A filter-expression can be any string of text containing the operators listed below.

### Filter Expression Values

Operator	Meaning	Example
Any character string not containing the special characters: . ? [ ] { } or \ (period, question mark, left/right brackets, left/right curly brackets, backslash).	Match the string literally.	super20 matches super20
\c where c is any of the special characters: . ? [ ] { } or \ (period, question mark, left/right brackets, left/right curly brackets, backslash)	Remove any special meaning of c.	\* matches *
. (period)	Any character.	. matches x
^ (caret)	Anchor the match at the beginning of the string.	^abc matches abc, but not aabc
\$ (dollar sign)	Anchor the match at the end of the string.	abc\$ matches abc but not abcc
? (question mark)	Repeat the preceding expression zero or one time.	aa? matches a or aa
* (asterisk)	Repeat the preceding expression zero or more times.	ab*c matches ac, abc, abbc, etc.
+ (plus symbol)	Repeat the preceding expression one or more times.	ab+c matches abc, abbc, etc.
[characterclass]	A series of nonrepeating characters denoting a class.	[abcdefghijklmnopqrstuvwxyz] is the class of all lowercase alphas.
[range\`rangeh]	A sequential range of nonrepeating characters denoting a class.	[a-z] is the class of all lowercase alphas.
[^characterclass]	Any character except those denoted by a character class.	[^a-z] matches a numeric digit or a punctuation mark.
[characterclass_tag]	[:alnum:] - Alphanumeric characters [:alpha:] - Alphabetic characters [:blank:] - Tab and space [:cntrl:] - Control characters [:digit:] - Numeric characters [:graph:] - All printable characters except space [:lower:] - Lowercase letters [:print:] - All printable characters [:punct:] - Punctuation [:space:] - White space characters [:upper:] - Uppercase letters [:xdigit:] - Hexadecimal digits	[:alpha:]* matches Dynaction, Selmer, or NewWonder but not Super20
{num}	Matches exactly <i>num</i> repetitions.	a{3} matches only aaa
{min,}	Matches at least <i>num</i> repetitions.	a{3,} matches aaaa but not aa

**Filter Expression Values (continued)**

Operator	Meaning	Example
{min,max}	A repetition operator like + or *, except the number of repetitions is specified by <i>min</i> and <i>max</i> .	[a-z]{1,3} matches a, ab, or aab, but not aabc
(expr1) (expr2)	Matches <i>expr1</i> or <i>expr2</i> .	a b matches a or b
(subexpression)	Grouping operator to consolidate terms into a subexpression, which can override the order of evaluation.  The subexpression is available for later matching or editing by means of <i>\index</i> , where <i>\index</i> is between 1-9 and refers to the index-th group in the string, counting from left to right. <i>\0</i> refers to the whole expression.	Overriding evaluation order: (ab)*c matches c, abc, ababc, etc.  Back-referencing: (aa)bb\1 matches aabbaa.

## Editing Expression Values

This table lists the valid operators for editing expressions.

Operator	Meaning	Example
\index	The <i>index-th</i> subexpression (reading left-right) in the matched string. <i>index</i> must be between 0`9. \0 is the matched expression itself.	M([0-9]{6})= > \1 produces 270494 when M270494 is scanned, stripping off the first character.
& or \0	The matched expression itself.	M[0-9]{6}= > \0-Conn and M[0-9]{6}= > &-Conn both produce M270494-Conn when M270494 is scanned.
\xhh	A concise representation of the lower 256 characters in the Unicode set. When converted, this is still a 16-bit value.	\x0d inserts a carriage return.
any character string	Inserts any character string in the output string.	See previous examples.

- *<symID>* is optional. If present, only data in the indicated symbology is accepted.
- If the entire expression is blank, all data is passed unchanged. If = > *editing-expression* is omitted, then all data that passes through the filter is returned unchanged. If = > *editing expression* is present, the data is transformed by editing-expression.
- Multiple grid expressions can be compiled and are related in a logical OR fashion. These are expressed as single grid expressions separated by semicolons. When matching is attempted, the first grid expression from left to right that achieves a match will cause the data to be accepted.
- All pattern expressions and parsed data are in Unicode.

### Grid Filter Example 1

This accepts a serial number in which the encoded number is a six-character string beginning with M followed by six numeric characters.

- **Filter**  
M[0-9]{6}
- **Effect**  
When a bar code, such as M270494, is scanned, all data is passed.

### Grid Filter Example 2

This formats a scanned Social Security number and forms it into an XML element tagged “SSN”.

- **Filter**  
([0-9]{3})([0-9]{2})([0-9]{4})= > <SSN > \1-\2-\3</SSN >
- **Effect**  
A bar code, such as 123456789, is passed and reformatted to <SSN > 123-45-6789</SSN >

**Grid Filter Example 3**

This deletes the first three and last five characters of a 21-character Code 128 label and deletes the first two characters of a 10-character Interleaved 2 of 5 label.

- **Filter**  
<]C > ...(.{13}).....= > \1; <]I > ..(.....)= > \1
- **Effect**  
If Code 128, AAA1234567890123BBBBB becomes 1234567890123  
If Interleaved 2 of 5, AA12345678 becomes 12345678

**Grid Filter Example 4**

This inverts data such that the first alphabetic string (like a first name) and second alphabetic string (like a last name) are reversed and separated by a comma and a space.

- **Filter**  
([[:alpha:]]+ ([[:alpha:]]+)= > \2, \1
- **Effect**  
When a bar code with the data “Dexter Gordon” is scanned, the data is modified to read “Gordon, Dexter”.

**ADC Connection**

A 700 Series Computer can have both Bar Code and RFID reader engines with each engine supporting multiple connections. Each connection allows an application to access data or manage a configuration. An application could have multiple connections.

```
// Get an instance of the ADC COM object that corresponds integrated scanner
IBarCodeReaderControl *pIBCControl;
// Pointer to the Bar Code Reader object
HRESULT hrStatus = ITCDeviceOpen( TEXT("default"),
IID_IBarCodeReaderControl, ITC_DHDEVFLAG_READAHEAD,
(LPVOID *) &pIBCControl);
// If the ADC object was successfully created and initialized, accept bar
code data.
ITC_BARCODE_DATA_DETAILS stBCDetails;
stBCDetails.wStructSize = sizeof(stBCDetails);
BYTE rgbBCData[1024];
//Buffer used to accept the bar code data
DWORD dwBytesReceived;
// Number of bytes in the return data.
HRESULT hrStatus = pIBCControl->Read(
rgbBCData,
sizeof(rgbBCData),
&dwBytesReceived,
& stBCDetails,
INFINITE
);
```

## 2D Imager Overview

The 700 Color optional integrated 2D Imager captures 640x480 256-grayscale images at 20 frames per second. The imager features can be categorized into data collection features and image acquisition features as follows:

### Data Collection Features

The imager includes a decode engine capable of decoding 2D matrix symbologies such as Data Matrix as well as the traditional 1D and stacked symbologies (*see the table on the next page for supported symbologies*). The application programming interfaces used to collect bar code data and configure the imager are the same as those used for the laser scanner. This includes the keyboard wedge as well as the ADC COM interfaces and includes functionality such as data editing and data filtering. In addition, the imager has the following configuration features (*see “IS9CConfig3 Functions” starting on page 216 for configuration details*):

- **Aimer LED:**  
A small, rectangular-aiming LED is displayed periodically during the image capture and decoding process. The initial duration (*after scan buttons are pressed*) of the aimer LED can be configured. This helps to select the specific bar code to be scanned with multiple bar codes in the image.
- **Scaled Illumination LED:**  
When the ambient light is not sufficient to decode the bar code, the red illumination LEDs will be turned on to brighten the image. The intensity of the illumination LEDs is scaled to brighten the image just enough for decode. This reduces power consumption and the effect of specular reflection.
- **Window size and position:**  
The default window size (640x480) can be reduced in size and positioned. This is useful in applications where multiple bar codes may be present in the image and the specific bar code must be selected to be read. For example, the window can be sized and positioned around the aimer LED. The entire bar code must reside in the configured window for a good decode.

Omni-directional scanning is a feature that does not require configuration. 1D and stacked symbologies as well as 2D matrix symbologies can be scanned with the 700 Series Computer in any orientation. Thus, time is not needed to orient the 700 horizontal as with laser scanners.

The following table shows which bar code symbologies are supported either by an imager or by a laser scanner.

Bar Code Symbology	Imager	Laser Scanner
Code 39	X	X
Interleaved 2 of 5	X	X
Standard 2 of 5	X	X
Matrix 2 of 5		X
Code 128	X	X
Code 93	X	X
Codabar	X	X
MSI		X
Plessey		X
UPC	X	X
EAN/EAN 128	X	X
Code 11		X
PDF 417	X	X
Micro PDF 417		X
Telepen		X
Data Matrix	X	
QR Code	X	

### Image Acquisition Features

The integrated imager provides the following image acquisition features:

- **Real-time and Still Image Acquisition:**  
This includes functions that start and stop image acquisition and read acquired images.
- **Signature Capture:**  
This allows the application to retrieve an image of the normalized signature. This means the image is always oriented as if the picture were taken at right angles to the signature, at the same distance, and in the center of the image no matter in what orientation the picture was taken.  
  
Signature capture requires a PDF 417 or Code 128 bar code symbology to be present in the image and requires the application to identify the X,Y offsets relative to the center the bar code, the X,Y dimension of image to be captured, and the aspect ratio of the bar code. Note the units are in terms of the narrow element width of the bar code.

See the following example signature capture label and dimensions. These image acquisition features are provided through the IImage Interface defined on page 221.

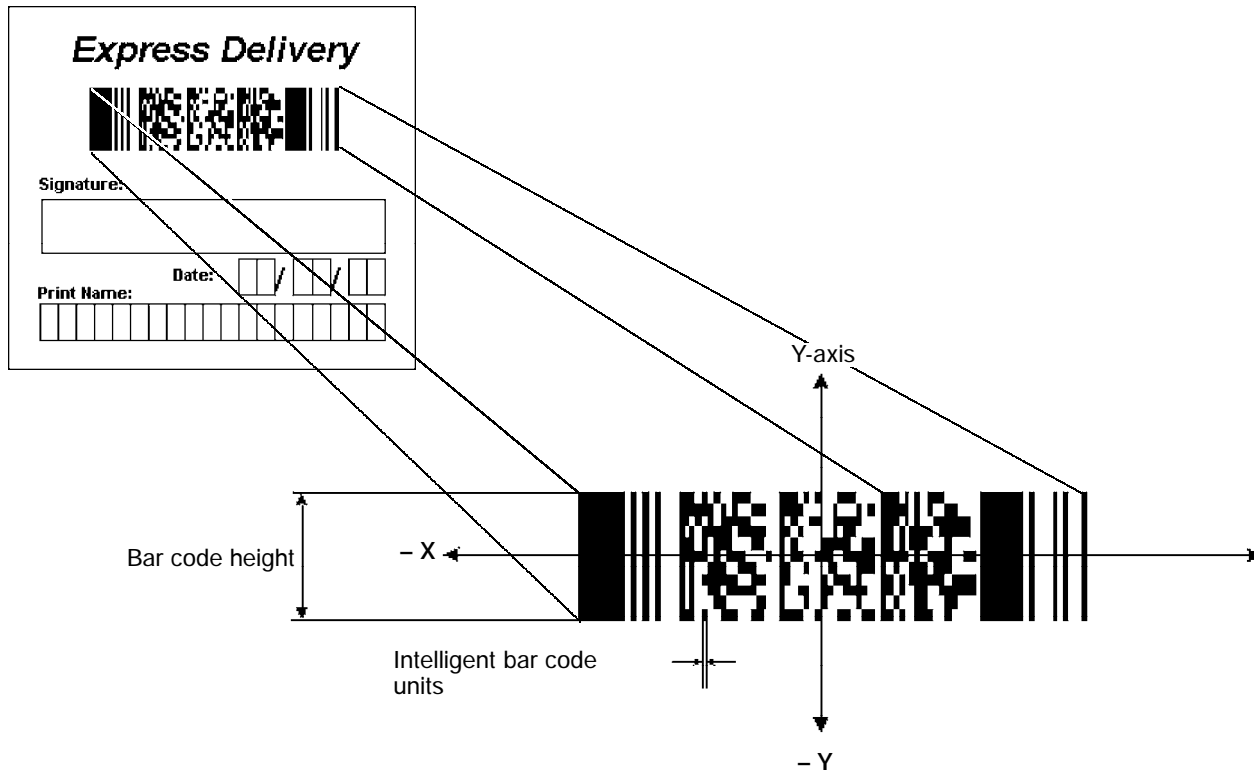



## Create and Delete ADC COM Object Functions

Use these functions to create and release ADC COM interfaces. ITCDEVMGMT.H is the header file and ITCDEVMGMT.LIB is the library.

### ITCDeviceOpen

This function opens and initializes a communication channel to the device. In C++, this function returns a pointer to an interface on which the methods are called. In C, this function returns a handle, which is the first parameter in each of the interface function calls.

### Syntax

```
HRESULT ITCDeviceOpen( LPCTSTR pszDeviceName, REFIID iid,
ITC_DEVICE_FLAGS eDeviceFlags, void** ppvObject );
```

### Parameters

<i>pszDevice</i>	[in]	Pointer to a string that contains the device name on which to initialize the logical connection. The device name (Merlin 1) identifies a communications port. Use “default” for all internal scanners, such as Imager, SE900, etc. Use “ExtScanner” for tethered scanners.
<i>iid</i>	[in]	The identifier of the interface being requested.
<i>eDeviceFlags</i>	[in]	Enumeration that identifies the read characteristics as follows: <ul style="list-style-type: none"> <li>• <b>ITC_DHDEVFLAG_READAHEAD</b> Data is buffered on behalf of the calling applications. Data Buffering starts after the first call to IADC::Read ().</li> <li>• <b>ITC_DHDEVFLAG_NODATA</b> The client application is managing the device to set its configuration or control its interface but not to collect data from the device.</li> </ul>
<i>ppvObject</i>	[out]	A pointer to the interface pointer identified by <i>iid</i> . If the object does not support this interface, <i>ppvObject</i> is set to NULL.

### Return Values

HRESULT that indicates success or failure.

### Remarks

None.

### See Also

- ITCDeviceClose

### **ITCDeviceClose**

This function closes the interface opened with ITCDeviceOpen.

#### **Syntax:**

```
HRESULT ITCDeviceClose( IUnknown** ppvObject );
```

#### **Parameters**

*ppvObject* [in,out] A pointer to the interface pointer created by ITCDeviceOpen. If successful on output, this pointer is set to NULL.

#### **Return Values**

None.

#### **Remarks**

On Windows, this interface decrements the reference count. So alternatively, IUnknown::Release() could be used and must be used if reference counting is performed with IUnknown::AddRef(). On DOS, this function closes all resources associated with the channel.

#### **See Also**

None.

## IADC Functions

IADC functions provide ADC data in an input device independent manner. This interface can receive bar code data, RFID data, and other ADC data from data collection engines, such as a bar code scanner. Use IADC functions if bar code specifics such as symbology are not important to the application.

IADC functions are the following. IADC.H is the header file and ITCUID.LIB contains the IID\_IADC Interface GUID value used to obtain the interface.

- IADC::CancelReadRequest (*page 152*)
- IADC::Initialize (*page 153*)
- IADC::QueryAttribute (*page 154*)
- IADC::QueryData (*page 155*)
- IADC::Read (*page 156*)
- IADC::SetAttribute (*page 157*)

**IADC::CancelReadRequest**

This function cancels a pending Read() request. This call can be made on a separate thread as a Read() or on the same thread. On a separate thread, the function is useful in unblocking a blocked Read() so that other operations can be performed. On the same thread, this function is useful in stopping data from being collected on behalf of a Read Ahead Client.

**Syntax**

```
HRESULT IADC::CancelReadRequest( BOOL FlushBufferedData, WORD
*pwTotalDiscardedMessages, DWORD *pdwTotalDiscardedBytes );
```

**Parameters**

<i>FlushBufferedData</i>	[in]	True	Flush and discard all already buffered data.
		False	Do not discard data, data will be returned on the next read call.
<i>pwTotalDiscardedMessages</i>	[in/out]		Total number of discarded buffered labels or tags.
<i>pdwTotalDiscardedBytes</i>			Total number of discarded bytes.

**Return Values**

HRESULT that indicates success or failure.

**Remarks**

The return value indicates whether a read was pending.

**See Also**

- IADC::Initialize
- IADC::QueryAttribute
- IADC::QueryData
- IADC::Read
- IADC::SetAttribute

**IADC::Initialize**

This function initializes a connection by opening a communications channel with a logical reader engine. The communications port is implicitly identified. This communication channel is required to collect data or configure the device.

**Syntax**

```
HRESULT IADC::Initialize ( LPCTSTR pszDeviceName,
ITC_DEVICE_FLAGS eDeviceFlags ) ;
```

**Parameters**

- |                      |      |  |
|----------------------|------|--|
| <i>pszDeviceName</i> | [in] | Pointer to a string that contains the device name on which to initialize the logical connection. The device name (Merlin 1) identifies a communications port. Use “default” for all internal scanners, such as Imager, SE900, etc. Use “ExtScanner” for tethered scanners. |
| <i>eDeviceFlags</i>  | [in] | Enumeration that identifies the read characteristic as follows: <ul style="list-style-type: none"> <li>• <b>ITC_DHDEVFLAG_READAHEAD</b><br/>Data is buffered on behalf of the calling application. Data buffering starts after the first call to IADC::Read ().</li> </ul> |

**Return Values**

HRESULT that indicates success or failure.

**Remarks**

None.

**See Also**

- IADC::CancelReadRequest
- IADC::QueryAttribute
- IADC::QueryData
- IADC::Read
- IADC::SetAttribute

**IADC::QueryAttribute**

This function retrieves a specified attribute that is device-independent. The specified attribute can be a grid or multiclient enable status.

**Syntax**

```
HRESULT IADC::QueryAttribute (
    ITC_ADC_ATTRIBUTE_ID eAttribID, BYTE rgbBuffer[], DWORD
    dwBufferSize, DWORD *pnBufferData );
```

**Parameters**

<i>eAttribID</i>	[in]	Specifies the attribute. Only one attribute can be queried at a time. See IADC::SetAttribute.
<i>rgbBuffer</i>	[out]	Contains buffer for the attribute to be queried. The structure of <i>lpBuffer</i> depends on the attribute being queried. See IADC::SetAttribute for a description of these structures.
<i>dwBufferSize</i>	[in]	The maximum number of bytes <i>rgbBuffer</i> can store.
<i>pnBufferData</i>	[out]	Pointer to the DWORD location to put the number of bytes stored in <i>rgbBuffer</i> .

**Return Values**

HRESULT that indicates success or failure.

**Remarks**

None.

**See Also**

- IADC::CancelReadRequest
- IADC::Initialize
- IADC::QueryData
- IADC::Read
- IADC::SetAttribute

**IADC::QueryData**

This function returns the status of user input data that has been buffered.

**Syntax**

```
HRESULT IADC::QueryData ( DWORD *dwTotalBufferedBytes, WORD
*wNumberOfMessages, DWORD *dwNextMessageSize );
```

**Parameters**

<i>dwTotalBufferedBytes</i>	[out]	Total bytes buffered for connection.
<i>wNumberOfMessages</i>	[out]	Total messages buffered. For example, each buffer contains a single bar code scan.
<i>dwNextMessageSize</i>	[out]	Size (in bytes) of the next buffered message.

**Return Values**

A standard status code that indicates success or failure.

**Remarks**

None.

**See Also**

- IADC::CancelReadRequest
- IADC::Initialize
- IADC::QueryAttribute
- IADC::Read
- IADC::SetAttribute

**IADC::Read**

This function requests user input data from the reader engine. This is a blocking function that returns either when there is data or after a timeout.

**Syntax**

```
HRESULT IADC::Read ( BYTE rgbDataBuffer[], DWORD
dwDataBufferSize, DWORD pnBytesReturned, SYSTEMTIME
pSystemTime, DWORD dwTimeout );
```

**Parameters**

<i>rgbDataBuffer</i>	[in]	Pointer to the buffer that receives the data from the device.
<i>dwDataBufferSize</i>	[in]	Maximum number of bytes that can be stored in <i>rgbDataBuffer</i> .
<i>pnBytesReturned</i>	[out]	Pointer to the DWORD location to store the number of bytes returned in <i>rgbDataBuffer</i> .
<i>pSystemTime</i>	[out]	Pointer to a SYSTEMTIME structure that will hold the time stamp of the received data. This can be NULL if a timestamp is not needed.
<i>dwTimeout</i>	[in]	Number of milliseconds caller waits for data. This parameter is ignored if the Read Ahead flag is not set. <ul style="list-style-type: none"> <li>• <b>0</b> If data is not available, returns quickly.</li> <li>• <b>INFINITE</b> Waits until data is available.</li> </ul>

**Return Values**

HRESULT that indicates success or failure.

**Remarks**

None.

**See Also**

- IADC::CancelReadRequest
- IADC::Initialize
- IADC::QueryAttribute
- IADC::QueryData
- IADC::SetAttribute



## IADC::SetAttribute

This function changes an attribute such as a grid specification.

### Syntax

```
HRESULT IADC::SetAttribute ( ITC_ADC_ATTRIBUTE_ID eAttribID,
BYTE rgbData[], DWORD nBufferSize );
```

### Parameters

- eAttribID* [in] Identifies the attribute to set. Only one attribute can be set at a time. The attribute is:
- **ITC\_MULTICLIENT\_ENABLE**  
Indicates whether this client can coexist with other clients.
- rgbData* [in] Contains data for the attribute to be set. Depending on the *eAttribID*, this will be mapped to the appropriate structure as follows:
- **ITC\_MULTICLIENT\_ENABLE**  
BOOL is the *rgbData* Data Structure.
    - TRUE, Client can receive data with other clients (*default*).
    - FALSE, Data stream to this client is turned off when there are other clients.
  - **ITC\_DHATTR\_READFILTER**  
ITC\_READFILTER is the *rgbData* Data Structure. The ITC\_READFILE structure is defined in IADCDEVICE.H as follows:

```
typedef struct
{
    #define ITC_MAXFILTER_CHARS 240
    WORD    nFilterChars;
    TCHAR    szFilter[ITC_MAXFILTER_CHARS];
} ITC_READFILTER;
```

where:

- **ITC\_MAXFILTER\_CHARS**  
Maximum number of characters in a filter specification. Includes NULL termination.
  - *nFilterChars* Number of characters in *pszDataMask*.
  - *szFilter* Data mask specification. See “*Grid Data Filtering*.”

*nBufferSize* [in] Number of bytes in *rgbData*.

### ITC\_DHATTR\_READFILTER

Regular expression that performs data filtering and data editing. See “*Grid Data Filtering*” on page 141 for more information.

### Return Values

A standard status code that indicates success or failure.

### Remarks

None.

**See Also**

- IADC::CancelReadRequest
- IADC::Initialize
- IADC::QueryAttribute
- IADC::QueryData
- IADC::Read

## IBarCodeReaderControl Functions

IBarCodeReaderControl functions provide functionality for bar code collection and control only. These functions allow an application to:

- Trigger the bar code laser scanner
- Disable the scanner
- Receive a bar code with details such as symbology scanned, data type (Unicode, ASCII), and the time the data was received.

These functions include the following. IBARCODEREADER.H is the header file and ITCUUUID.LIB contains the IID\_IADC Interface GUID value used to obtain the interface.

- IBarCodeReaderControl::CancelReadRequest (*page 160*)
- IBarCodeReaderControl::ControlLED (*page 161*)
- IBarCodeReaderControl::Initialize (*page 162*)
- IBarCodeReaderControl::IssueBeep (*page 163*)
- IBarCodeReaderControl::QueryAttribute (*page 164*)
- IBarCodeReaderControl::Read (*page 165*)
- IBarCodeReaderControl::SetAttribute (*page 167*)
- IBarCodeReaderControl::TriggerScanner (*page 171*)

**IBarcodeReaderControl::CancelReadRequest**

This function cancels a pending IBarcodeReaderControl::Read request. If the read request is blocked, issue the CancelReadRequest from a separate thread.

**Syntax**

```
HRESULT IBarcodeReaderControl::CancelReadRequest( BOOL
FlushBufferedData, WORD *pwTotalDiscardedMessages,WORD
*pwTotalDiscardedBytes );
```

**Parameters**

<i>FlushBufferedData</i>	[in] TRUE	Flushes and discards all buffered data.
	FALSE	Does not discard data; data will be returned on the next read call.
<i>pwTotalDiscardedMessages</i>	[in/out]	Total number of discarded buffered labels or tags.
<i>pwTotalDiscardedBytes</i>		Total number of discarded bytes.

**Return Values**

HRESULT that indicates success or failure.

**Remarks**

None.

**See Also**

- IBarcodeReaderControl::ControlLED
- IBarcodeReaderControl::Initialize
- IBarcodeReaderControl::IssueBeep
- IBarcodeReaderControl::QueryAttribute
- IBarcodeReaderControl::Read
- IBarcodeReaderControl::SetAttribute
- IBarcodeReaderControl::TriggerScanner

**IBarCodeReaderControl::ControlLED**

This function controls LED illumination on a tethered scanner. The good read LED and any valid LEDs will be turned on and off based on defined parameters.

**Syntax**

```
HRESULT IBarcodeReaderControl::ControlLED (
ITC_BARCODE_LASER_LED_ID eLED, BOOL fLedOn );
```

**Parameters**

*eLED* [in] The specified LED identifier.

- ITC\_BARCODE\_LASER\_GOOD\_READ\_LED  
Identifies the good read LED.

*fLedOn* [in] TRUE turns on the LED. FALSE turns off the LED.

**Return Values**

HRESULT that indicates success or failure.

**Remarks**

This function does not coordinate LED control with the scanner. If the scanner LED control is enabled, function results will be unpredictable.

**See Also**

- IBarcodeReaderControl::CancelReadRequest
- IBarcodeReaderControl::Initialize
- IBarcodeReaderControl::IssueBeep
- IBarcodeReaderControl::QueryAttribute
- IBarcodeReaderControl::Read
- IBarcodeReaderControl::SetAttribute
- IBarcodeReaderControl::TriggerScanner

**IBarCodeReaderControl::Initialize**

This function opens and initializes a communications channel with a logical bar code reader engine.

**Syntax**

```
HRESULT IBarCodeReaderControl::Initialize ( LPCTSTR
pszDeviceName, ITC_DEVICE_FLAGS eDeviceFlags ) ;
```

**Parameters**

- |                      |      |   |
|----------------------|------|---|
| <i>pszDeviceName</i> | [in] | Pointer to a string with device on which to initialize the logical connection. The device identifies a communications port. Use “default” for all internal scanners, such as Imager, SE900, etc. Use “ExtScanner” for tethered scanners.                                    |
| <i>eDeviceFlags</i>  | [in] | Enumeration that identifies the read characteristic as follows: <ul style="list-style-type: none"> <li>• <b>ITC_DHDEVFLAG_READAHEAD</b><br/>Data is buffered on behalf of the calling applications. Data Buffering starts after the first call to IADC::Read ().</li> </ul> |

**Return Values**

HRESULT that indicates success or failure.

**Remarks**

None.

**See Also**

- IBarCodeReaderControl::CancelReadRequest
- IBarCodeReaderControl::ControlLED
- IBarCodeReaderControl::IssueBeep
- IBarCodeReaderControl::QueryAttribute
- IBarCodeReaderControl::Read
- IBarCodeReaderControl::SetAttribute
- IBarCodeReaderControl::TriggerScanner

## IBarCodeReaderControl::IssueBeep

This function causes the reader engine to generate a high beep, a low beep, or a custom beep. The high beep and low beep are preconfigured beep tones and durations. The custom beep allows the client to specify the frequency and duration. The volume is the current volume setting. *Note this is not implemented.*

### Syntax

```
HRESULT IBarCodeReaderControl::IssueBeep( ITC_BEEP_SPEC
rgBeepRequests[], DWORD dwNumberOfBeeps );
```

### Parameters

*rgBeepRequests* [in] Array of ITC\_BEEP\_SPEC structures that identifies the beep type. The beep structure is:

```
typedef struct tagITCBeepSpec
{
    ITC_BEEP_TYPE eBeepType; // Identifies the type of beep
    // Following fields used only if the beep type is ITC_CUSTOM_BEEP.
    WORD wPitch; // Frequency, in Hz, of the beep.
    WORD wOnDuration; // Duration, in milliseconds, of Beep On.
    WORD wOffDuration; // Duration, in milliseconds, of Beep Off
    // Beep Off is used to separate individual beeps
} ITC_BEEP_SPEC;
typedef enum tagITCBeepType
{
    ITC_LOW_BEEP, // Issue the default low beep.
    ITC_HIGH_BEEP, // Issue the default high beep.
    ITC_CUSTOM_BEEP, // Issue a custom beep.
} ITC_BEEP_TYPE;
```

*dwNumberOfBeeps* [in] Identifies the total number of beeps in *rgBeepRequests*.

### Return Values

E\_NOTIMPL as this function is not implemented.

### Remarks

None.

### See Also

- IBarCodeReaderControl::CancelReadRequest
- IBarCodeReaderControl::ControlLED
- IBarCodeReaderControl::Initialize
- IBarCodeReaderControl::QueryAttribute
- IBarCodeReaderControl::Read
- IBarCodeReaderControl::SetAttribute
- IBarCodeReaderControl::TriggerScanner

**IBarcodeReaderControl::QueryAttribute**

This function retrieves the device-specific grid, the scanner enable status, and the LED control status for the current bar code reader engine.

**Syntax**

```
HRESULT IBarcodeReaderControl::QueryAttribute (
    ITC_BARCODEREADER_ATTRIBUTE_ID eAttr, BYTE rgbAttrBuffer[],
    DWORD dwAttrBufferSize );
```

**Parameters**

<i>eAttr</i>	[in]	Specifies the attribute. See IBarcodeReaderControl::SetAttribute on page 167 for the attributes.
<i>rgbAttrBuffer</i>	[out]	Contains buffer for the attribute to be queried. The structure of <i>rgbAttrBuffer</i> depends on the attribute being queried. See IBarcodeReaderControl::SetAttribute for a description of these structures.
<i>dwAttrBufferSize</i>	[in]	The maximum number of bytes that <i>rgbAttrBuffer</i> can store.

**Return Values**

A standard status code that indicates success or failure.

**Remarks**

The following attributes are not supported on the imager:

- ITC\_RDRATTR\_TONE\_ENABLE
- ITC\_RDRATTR\_VOLUME\_LEVEL
- ITC\_RDRATTR\_TONE\_FREQUENCY
- ITC\_RDRATTR\_GOOD\_READ\_BEEPS\_NUMBER
- ITC\_RDRATTR\_GOOD\_READ\_BEEP\_DURATION

**See Also**

- IBarcodeReaderControl::CancelReadRequest
- IBarcodeReaderControl::ControlLED
- IBarcodeReaderControl::Initialize
- IBarcodeReaderControl::IssueBeep
- IBarcodeReaderControl::Read
- IBarcodeReaderControl::SetAttribute
- IBarcodeReaderControl::TriggerScanner



**IBarCodeReaderControl::Read**

This function reads data from the bar code input device. This method performs the same function as IADC::Read () except that it provides additional information about data received such as bar code symbology used, data type, and time stamp of received data.

**Syntax**

```
HRESULT IBarCodeReaderControl::Read ( BYTE
    rgbDataBuffer[], DWORD dwDataBufferSize, DWORD
    pnBytesReturned, ITC_BARCODE_DATA_DETAILS
    pBarCodeDataDetails, DWORD dwTimeout );
```

**Parameters**

<i>rgbDataBuffer</i>	[in]	Pointer to the buffer that receives data from the device.
<i>dwDataBufferSize</i>	[in]	Maximum number of bytes that can be stored in <i>rgbDataBuffer</i> .
<i>pnBytesReturned</i>	[out]	Pointer to the DWORD location that will store the bytes returned in <i>rgbDataBuffer</i> .
<i>pBarCodeDataDetails</i>	[in]	Address of data structure in which to put the data details. This may be NULL. The ITC_BARCODE_DATA_DETAILS is:

```
typedef struct tagITCBarCodeDetails
{
    WORD wStructSize,
    ITC_BARCODE_SYMBOLGY_ID eSymbology,
    ITC_BARCODE_DATATYPE eDataType,
    SYSTEMTIME stTimeStamp,
} ITC_BARCODE_DATA_DETAILS;

typedef enum tagBarCodeDataType
{
    BARCODE_DATA_TYPE_UNKNOWN = 1,
    BARCODE_DATA_TYPE_ASCII,
    BARCODE_DATA_TYPE_UNICODE,
} ITC_BARCODE_DATATYPE;
```

where:

- *wStructSize* Size of structure. Used for versioning structure.
- *eSymbology* Symbology of the returned data.
- *eDataType* Identifies data types as ASCII, UNICODE, etc.
- *stTimeStamp* Timestamp of the received data.
- **BARCODE\_DATA\_TYPE\_UNKNOWN** Data in unknown.
- **BARCODE\_DATA\_TYPE\_ASCII** Data is ASCII.
- **BARCODE\_DATA\_TYPE\_UNICODE** Data is UNICODE.

*dwTimeout* [in] Number of milliseconds caller waits for data. If you set a timeout, the call will be blocked until data is received.

- **0**  
If data not available, returns quickly.
- **INFINITE**  
Waits until data is available.

### Return Values

HRESULT that indicates success or failure.

### Remarks

None.

### See Also

- `IBarCodeReaderControl::CancelReadRequest`
- `IBarCodeReaderControl::ControlLED`
- `IBarCodeReaderControl::Initialize`
- `IBarCodeReaderControl::IssueBeep`
- `IBarCodeReaderControl::QueryAttribute`
- `IBarCodeReaderControl::SetAttribute`
- `IBarCodeReaderControl::TriggerScanner`

**IBarcodeReaderControl::SetAttribute**

This function enables and disables the laser scanner, sets the bar code reader engine specific grid, and enables or disables the reader engine LED control.

**Syntax**

```
HRESULT IBarcodeReaderControl::SetAttribute (
ITC_BARCODEREADER_ATTRIBUTE_ID eAttr, BYTE rgbAttrBuffer[],
DWORD dwAttrBufferSize );
```

**Parameters**

*eAttr* [in] Identifies the attribute to set. Only one attribute can be set at a time. The attributes are:

- **ITC\_RDRATTR\_SCANNER\_ENABLE**  
Enable or disable scanner for all connections.
- **ITC\_RDRATTR\_GOOD\_READ\_LED\_ENABLE**  
Enables and disables the reader engine from controlling the good read LED.
- **ITC\_RDRATTR\_TONE\_ENABLE**  
Enables and disables the reader engine from issuing beeps.
- **ITC\_RDRATTR\_VOLUME\_LEVEL**  
Sets beep volume level.
- **ITC\_RDRATTR\_TONE\_FREQUENCY**  
Sets beep frequency.
- **ITC\_RDRATTR\_GOOD\_READ\_BEEPS\_NUMBER**  
Sets number of beeps for a good read.
- **ITC\_RDRATTR\_GOOD\_READ\_BEEP\_DURATION**  
Sets duration of beeps for a good read.
- **ITC\_DHATTR\_READFILTER**  
The ITC\_READFILTER is the *rgbData* Data Structure. The ITC\_READFILE structure is defined in IADCDEVICE.H as follows:

```
typedef struct
{
#define ITC_MAXFILTER_CHARS 240
WORD nFilterChars;
TCHAR szFilter[ITC_MAXFILTER_CHARS];
} ITC_READFILTER;
```

where:

- *nFilterChars* Number of characters in *pszDataMask*.
- *szFilter* Data mask specification. See “Grid Data Filtering.”
- **ITC\_MAXFILTER\_CHARS**  
Maximum number of characters in a filter specification. Includes NULL termination.

*rgbAttrBuffer* [in] Contains data for the attribute to be set. Depending on *eAttr*, the *rgbAttrData* will be mapped to the appropriate structure as shown in the following table .

### **rgbAttrBuffer Data Structures**

<b>eAttr</b>	<b>Data Structure contained in rgbAttrBuffer</b>
ITC_RDRATTR_GRID	ITC_BARCODEREADER_READER_GRID Reader Engine specific grid only.
ITC_RDRATTR_SCANNER_ENABLE	BOOL TRUE Enable scanner. FALSE Disable scanner.
ITC_RDRATTR_GOOD_READ_LED_ENABLE	BOOL TRUE Reader Engine controls good read LED. FALSE Good read LED is not controlled.
ITC_RDRATTR_DATA_VALID_LED_ENABLE	BOOL TRUE Reader Engine controls data valid LED. FALSE Data valid LED is not controlled.
ITC_RDRATTR_TONE_ENABLE	BOOL TRUE Reader Engine issues beeps. FALSE Beeps are not issued.
ITC_RDRATTR_VOLUME_LEVEL	ITC_BEEP_VOLUME An enumerator that identifies the beep volume level control. Valid range for S9C: <pre>typedef enum tagBeepVolume {     ITC_BEEP_VOLUME_LOW = 0,     ITC_BEEP_VOLUME_MEDIUM = 2,     ITC_BEEP_VOLUME_HIGH = 1 //Default } ITC_BEEP_VOLUME</pre> <i>Note:</i> Due to the hardware design on this 700 Series Computer, the volume level can be either OFF ( <i>ITC_BEEP_VOLUME_LOW</i> ) or ON ( <i>ITC_BEEP_VOLUME_MEDIUM/HIGH</i> ).
ITC_RDRATTR_TONE_FREQUENCY	DWORD A value that identifies the tone frequency in Hz. Valid range for S9C: 1000`4095 Hz ( <i>default: 2090</i> ). <i>Note:</i> Value is divided by 10 for storage. On retrieval, the scanner rounds off the value to the nearest 10 Hz, then multiplies the value by 10. For example, the value sent to the scanner is 2095. On retrieval, the value returned is 2090.

**rgbAttrBuffer Data Structures (continued)**

eAttr	Data Structure contained in rgbAttrBuffer
ITC_RDRATTR_GOOD_READ_BEEPS_NUMBER	ITC_GOOD_READ_BEEPS_NUMBER An enumerator identifying the good read beeps number. Valid range for S9C: <pre>typedef enum tagGoodReadBeepsNumber {     ITC_NUM_BEEPS_NONE = 0,     ITC_NUM_BEEPS_ONE = 1, // Default     ITC_NUM_BEEPS_TWO = 2 } ITC_GOOD_READ_BEEPS_NUMBER</pre>
ITC_RDRATTR_GOOD_READ_BEEP_DURATION	DWORD Value identifying the good read beep duration in ms. Valid range for S9C: 0-2550 ms ( <i>Default: 80</i> ). <i>Note: Value is divided by 10 for storage. On retrieval, the scanner rounds the value to the nearest 10 ms, then multiplies the value by 10.</i>

*dwAttrBufferSize* [in] The size of *rgbAttrBuffer* in bytes.

**Return Values**

HRESULT that indicates success or failure.

**Remarks**

Read ahead and non-read ahead clients can change the grid. Since changing the grid changes the entire reader engine grid, use `IBarCodeReaderControl::QueryAttribute` to retrieve the current reader engine grid and grid changes before sending back using `SetAttribute`. The grid structure is *typedef struct tagBarCodeReaderGrid*.

```
{
ITC_DI_GRID stDIGrid; // Device independent grid.
ITC_DDBARCODE_GRID stDDGrid; // Reader engine dependent grid
DWORD dwDataSourceTypeMask;
} ITC_BARCODEREADER_GRID;

ITC_DI_GRID

typedef struct tagItcBarCodeGrid
{
    DWORD dwSymbologyMask; // Symbologies to be received.
} ITC_DDBARCODE_GRID;
```

When the scanner is enabled, it scans when the scan button is pressed or the trigger is pulled. When the scanner is disabled, it does not respond when the scan button is pressed or the trigger is pulled.

The following attributes are not supported on the imager:

- ITC\_RDRATTR\_TONE\_ENABLE
- ITC\_RDRATTR\_VOLUME\_LEVEL
- ITC\_RDRATTR\_TONE\_FREQUENCY
- ITC\_RDRATTR\_GOOD\_READ\_BEEPS\_NUMBER
- ITC\_RDRATTR\_GOOD\_READ\_BEEP\_DURATION

**See Also**

- IBarcodeReaderControl::CancelReadRequest
- IBarcodeReaderControl::ControlLED
- IBarcodeReaderControl::Initialize
- IBarcodeReaderControl::IssueBeep
- IBarcodeReaderControl::QueryAttribute
- IBarcodeReaderControl::Read
- IBarcodeReaderControl::TriggerScanner

**IBarCodeReaderControl::TriggerScanner**

This function turns the scanner on and off. The client application must coordinate control of the scanner with the user.

**Syntax**

```
HRESULT IBarcodeReaderControl::TriggerScanner ( BOOL
    fScannerOn );
```

**Parameters**

*fScannerOn* [in] Set TRUE to turn the scanner on. Set FALSE to turn the scanner off.

**Return Values**

HRESULT that indicates success or failure.

**Remarks**

The scanner will be turned on or off independent of the actions of the users. The client application must coordinate control of the scanner with the user. When the scanner is turned on, its behavior is controlled by the trigger mode. That is, in one shot mode, the laser turns off when a label is scanned; in auto-trigger mode, the laser remains on.

**See Also**

- IBarcodeReaderControl::CancelReadRequest
- IBarcodeReaderControl::ControlLED
- IBarcodeReaderControl::Initialize
- IBarcodeReaderControl::IssueBeep
- IBarcodeReaderControl::QueryAttribute
- IBarcodeReaderControl::Read
- IBarcodeReaderControl::SetAttribute

## IS9CConfig Functions

This interface provides methods to set and retrieve the 700 Series Computer bar code configuration. All supported symbologies are initialized to their defaults when the S9C firmware is loaded.

GET/SET functions use enumerations as their parameters. In most enumerations, there is an enumerator `xx_NO_CHANGE` (such as `ITC_CODE39_NO_CHANGE`), where `xx` refers to a particular enumeration. This enumerator can be used during a call to a SET to indicate that no change is to be made to that particular parameter. This prevents the called function from having to format the same S9C command and send down to the S9C scanner.

For all symbologies, to set a bar code length of “any length,” use a value of “0” for the bar code length argument.

IS9CConfig functions are the following. `IS9CCONFIG.H` is the header file and `ITCUUID.LIB` contains the `IID_IADC` Interface GUID value used to obtain the interface.

- `IS9CConfig::GetCodabar` (*page 173*)
- `IS9CConfig::SetCodabar` (*page 174*)
- `IS9CConfig::GetCode39` (*page 176*)
- `IS9CConfig::SetCode39` (*page 177*)
- `IS9CConfig::GetCode93` (*page 179*)
- `IS9CConfig::SetCode93` (*page 179*)
- `IS9CConfig::GetCode128` (*page 180*)
- `IS9CConfig::SetCode128` (*page 181*)
- `IS9CConfig::GetI2of5` (*page 183*)
- `IS9CConfig::SetI2of5` (*page 184*)
- `IS9CConfig::GetMatrix2of5` (*page 185*)
- `IS9CConfig::SetMatrix2of5` (*page 186*)
- `IS9CConfig::GetMSI` (*page 187*)
- `IS9CConfig::SetMSI` (*page 187*)
- `IS9CConfig::GetPDF417` (*page 188*)
- `IS9CConfig::SetPDF417` (*page 189*)
- `IS9CConfig::GetPlessey` (*page 192*)
- `IS9CConfig::SetPlessey` (*page 192*)
- `IS9CConfig::GetStandard2of5` (*page 194*)
- `IS9CConfig::SetStandard2of5` (*page 195*)
- `IS9CConfig::GetTelepen` (*page 197*)
- `IS9CConfig::SetTelepen` (*page 197*)
- `IS9CConfig::GetUpcEan` (*page 198*)
- `IS9CConfig::SetUpcEan` (*page 200*)



**IS9CConfig::GetCodabar**

This function retrieves the current settings of Codabar symbology.

**Syntax**

```
HRESULT IS9CConfig::GetCodabar( ITC_CODABAR_DECODING*
peDecode, ITC_CODABAR_START_STOP* peSS, ITC_CODABAR_CLSI*
peCLSI, ITC_CODABAR_CHECK_DIGIT* peCheck,
ITC_BARCODE_LENGTH_ID* peLengthId, BYTE rgbLengthBuff[],
DWORD* pdwNumBytes );
```

**Parameters**

<i>peDecode</i>	[out]	Pointer to the ITC_CODABAR_DECODING location to receive the decoding for Codabar symbology.
<i>peSS</i>	[out]	Pointer to the ITC_CODABAR_START_STOP location to receive the Start/Stop option.
<i>peCLSI</i>	[out]	Pointer to the ITC_CODABAR_CLSI location to receive the CLSI library system.
<i>peCheck</i>	[out]	Pointer to the ITC_CODABAR_CHECK_DIGIT location to receive the check digit.
<i>peLengthId</i>	[out]	Pointer to the ITC_BARCODE_LENGTH_ID location to receive an indicator of either ITC_BARCODE_LENGTH or ITC_BARCODE_FIXED_LENGTH.
<i>rgbLengthBuff</i>	[out,size_is(3)]	An array of bytes to receive 1 byte of data for ITC_BARCODE_LENGTH, or 3 bytes of data for ITC_BARCODE_FIXED_LENGTH.
<i>pdwNumBytes</i>	[out]	Pointer to the DWORD location to receive a number indicating number of bytes in <i>rgbLengthBuff</i> : 1 byte for ITC_BARCODE_LENGTH or 3 bytes for ITC_BARCODE_FIXED_LENGTH.

**Return Values**

HRESULT that indicates success or failure.

**Remarks**

None.

**See Also**

None.

**IS9CConfig::SetCodabar**

This function updates the Codabar settings with new values.

**Syntax**

```
HRESULT IS9CConfig::SetCodabar( ITC_CODABAR_DECODING
eDecode, ITC_CODABAR_START_STOP eSS, ITC_CODABAR_CLSI
eCLSI, ITC_CODABAR_CHECK_DIGIT eCheck, ITC_BARCODE_LENGTH_ID
eLengthId, BYTE rgbLengthBuff[], DWORD dwNumBytes );
```

**Parameters**

<i>eDecode</i>	[in]	Identifies the decoding for Codabar symbology.
<i>eSS</i>	[in]	Identifies the Start/Stop option.
<i>eCLSI</i>	[in]	Identifies the CLSI library system.
<i>eCheck</i>	[in]	Identifies the check digit.
<i>eLengthId</i>	[in]	Use ITC_BARCODE_LENGTH_NO_CHANGE to indicate no change for bar code length. Use ITC_BARCODE_LENGTH for any length and minimum length, and set <i>rgbLengthBuff[0]</i> to a valid length value. Use ITC_BARCODE_FIXED_LENGTH to compose 1 or 2 or 3 fixed lengths, and set 3 bytes: <i>rgbLengthBuff[0]</i> , <i>rgbLengthBuff[1]</i> , <i>rgbLengthBuff[2]</i> with valid values.
<i>rgbLengthBuff</i>	[in, size_is(dwNumBytes)]	An array of bytes containing bar code lengths when <i>eLengthId</i> = ITC_BARCODE_LENGTH or ITC_BARCODE_FIXED_LENGTH.
<i>dwNumBytes</i>	[in]	Number of bytes in <i>rgbLengthBuff[]</i> . For S9C, this value is 1 when <i>eLengthId</i> = ITC_BARCODE_LENGTH or 3 when <i>eLengthId</i> = ITC_BARCODE_FIXED_LENGTH

**Return Values**

HRESULT that indicates success or failure.

**Remarks**

None.

**See Also**

None.

## Codabar Default Settings

Parameter	Default	Valid Range
Decode	Not Active	ITC_CODABAR_DECODING
CLSI Library System	Not Active	ITC_CODABAR_CLSI
Start/Stop	Not Transmitted	ITC_CODABAR_START_STOP
Check Digit	Not Used	ITC_CODABAR_CHECK_DIGIT
Bar Code Length	Minimum Length = 6	0x00`0xFE ITC_BC_LENGTH_NO_CHANGE

## Codabar Enumerations

```

typedef enum tagCodabarDecoding
{
    ITC_CODABAR_NOTACTIVE = 0,           // Default
    ITC_CODABAR_ACTIVE = 1,
    ITC_CODABAR_NO_CHANGE = 255
} ITC_CODABAR_DECODING;

typedef enum tagCodabarStartStop
{
    ITC_CODABAR_SS_NOTXMIT,             // Default
    ITC_CODABAR_SS_LOWERABCD,          // a,b,c,d
    ITC_CODABAR_SS_UPPERABCD,          // A,B,C,D
    ITC_CODABAR_SS_LOWERABCDTN,        // a,b,c,d / t,n,*,e
    ITC_CODABAR_SS_DC1TODC4,           // DC1,DC2,DC3,DC4
    ITC_CODABAR_SS_NO_CHANGE = 255
} ITC_CODABAR_START_STOP;

typedef enum tagCodabarClsi
{
    ITC_CODABAR_CLSI_NOTACTIVE = 0,     // Default
    ITC_CODABAR_CLSI_ACTIVE = 1,
    ITC_CODABAR_CLSI_NO_CHANGE = 255
} ITC_CODABAR_CLSI;

typedef enum tagCodabarCheckDigit
{
    ITC_CODABAR_CHECK_NOTUSED,          // Default
    ITC_CODABAR_CHECK_XMIT,
    ITC_CODABAR_CHECK_NOTXMIT,
    ITC_CODABAR_CHECK_NO_CHANGE = 255
} ITC_CODABAR_CHECK_DIGIT;

typedef enum tagBarcodeLengthId
{
    ITC_BARCODE_LENGTH = 0,
    ITC_BARCODE_FIXED_LENGTH,
    ITC_BARCODE_LENGTH_NO_CHANGE = 255
} ITC_BARCODE_LENGTH_ID;

```

**IS9CConfig::GetCode39**

This function retrieves the current settings of Code 39.

**Syntax**

```
HRESULT IS9Cconfig::GetCode39( ITC_CODE39_DECODING*
peDecode, ITC_CODE39_FORMAT* peFormat,
ITC_CODE39_START_STOP* peSS, ITC_CODE39_SS_CHARS* peSSChars,
ITC_CODE39_CHECK_DIGIT* peCheck, DWORD* pwLength );
```

**Parameters**

<i>peDecode</i>	[out]	Pointer to the ITC_CODE39_DECODING location to receive the decoding for Code 39.
<i>peFormat</i>	[out]	Pointer to the ITC_CODE39_FORMAT location to receive the Code 39 format.
<i>peSS</i>	[out]	Pointer to the ITC_CODE39_START_STOP location to receive the Code 39 start/stop.
<i>peSSChars</i>	[out]	Pointer to the ITC_CODE39_SS_CHARS location to receive the Start/Stop character.
<i>peCheck</i>	[out]	Pointer to the ITC_CODE39_CHECK_DIGIT location to receive the check digit.
<i>pwLength</i>	[out]	Pointer to the DWORD location to receive the bar code length.

**Return Values**

HRESULT that indicates success or failure.

**Remarks**

None.

**See Also**

None.

**IS9CConfig::SetCode39**

This function updates the Code 39 settings with new values.

**Syntax**

```
HRESULT IS9CConfig::SetCode39( ITC_CODE39_DECODING
eDecode, ITC_CODE39_FORMAT eFormat, ITC_CODE39_START_STOP
eSS, ITC_CODE39_SS_CHARS eSSChars, ITC_CODE39_CHECK_DIGIT
eCheck, DWORD dwLength );
```

**Parameters**

*eDecode* [in] Identifies the decoding for Code 39.

*eFormat* [in] Identifies the Code 39 Format.

*eSS* [in] Identifies the Start/Stop option.

*eSSChars* [in] Identifies the Start/Stop character.

*eCheck* [in] Identifies the Check digit.

*dwLength* [in] Identifies the bar code length.

**Return Values**

HRESULT that indicates success or failure.

**Remarks**

None.

**See Also**

None.

**Code 39 Default Settings**

Parameter	Default	Valid Range
Decoding	Active	ITC_CODE39_DECODING
Format	Standard 43 Character	ITC_CODE39_FORMAT
Start/Stop	Not Transmitted	ITC_CODE39_START_STOP
Accepted Start/stop Characters	* only	ITC_CODE39_SS_CHARS
Check Digit	Not Used	ITC_CODE39_CHECK_DIGIT
Bar Code Length	Any Bar Code Length	0x00`0xFE ITC_BC_LENGTH_NO_CHANGE

**Code 39 Enumerations**

```
typedef enum tagCode39Decoding
{
ITC_CODE39_NOTACTIVE = 0,
ITC_CODE39_ACTIVE = 1,           // Default
ITC_CODE39_NO_CHANGE = 255
} ITC_CODE39_DECODING;

typedef enum tagCode39Format
{
ITC_CODE39_FORMAT_STANDARD43,    // Default
ITC_CODE39_FORMAT_FULLASCII,
ITC_CODE39_FORMAT_NO_CHANGE = 255
} ITC_CODE39_FORMAT;

typedef enum tagCode39StartStop
{
ITC_CODE39_SS_NOTXMIT,          // Default
ITC_CODE39_SS_XMIT,
ITC_CODE39_SS_NO_CHANGE = 255
} ITC_CODE39_START_STOP;

typedef enum tagCode39StartStopChars
{
ITC_CODE39_SS_CHARS_DOLLARSIGN,
ITC_CODE39_SS_CHARS_ASTERISK,    // Default
ITC_CODE39_SS_CHARS_BOTH,
ITC_CODE39_SS_CHARS_NO_CHANGE = 255
} ITC_CODE39_SS_CHARS;

typedef enum tagCode39CheckDigit
{
ITC_CODE39_CHECK_NOTUSED,       // Default
ITC_CODE39_CHECK_MOD43_XMIT,
ITC_CODE39_CHECK_MOD43_NOTXMIT,
ITC_CODE39_CHECK_FRENCH_CIP_XMIT,
ITC_CODE39_CHECK_FRENCH_CIP_NOTXMIT,
ITC_CODE39_CHECK_ITALIAN_CPI_XMIT,
ITC_CODE39_CHECK_ITALIAN_CPI_NOTXMIT,
ITC_CODE39_CHECK_NO_CHANGE = 255
} ITC_CODE39_CHECK_DIGIT;
```

**IS9CConfig::GetCode93**

This function retrieves the current settings of Code 93.

**Syntax**

```
HRESULT IS9CConfig::GetCode93( ITC_CODE93_DECODING*
peDecode, DWORD* pdwLength );
```

**Parameters**

*peDecode* [out] Pointer to the ITC\_CODE93\_DECODING location to receive the decoding for Code 93 symbology.

*pdwLength* [out] Pointer to the DWORD location to receive a value for bar code length.

**Return Values**

HRESULT that indicates success or failure.

**Remarks**

None.

**See Also**

None.

**IS9CConfig::SetCode93**

This function updates the Code 93 settings with new values.

**Syntax**

```
HRESULT IS9CConfig::SetCode93( ITC_CODE93_DECODING
eDecode, DWORD dwLength );
```

**Parameters**

*eDecode* [in] Identifies the decoding for Code93 Symbology.

*dwLength* [in] Identifies the bar code length.

**Return Values**

HRESULT that indicates success or failure.

**Remarks**

None.

**See Also**

None.

**Code 93 Default Settings**

Parameter	Default	Valid Range
Decoding	Not Active	ITC_CODE93_DECODING
Bar Code Length	Any Bar Code Length	0x00'0xFE ITC_BC_LENGTH_NO_CHANGE

## Code 93 Enumerations

Use this when the bar code length does not require any change.

```
typedef enum tagCode93Decoding
{
    ITC_CODE93_NOTACTIVE = 0,          // Default
    ITC_CODE93_ACTIVE = 1,
    ITC_CODE93_NO_CHANGE = 255
} ITC_CODE93_DECODING;
#define ITC_BC_LENGTH_NO_CHANGE 255.
```

## IS9CConfig::GetCode128

This function retrieves the current settings of Code 128 symbology.

### Syntax

```
HRESULT IS9Cconfig::GetCode128( ITC_CODE128_DECODING*
    peDecode, ITC_EAN128_IDENTIFIER* peEan128Ident,
    ITC_CODE128_CIP128 peCip128State, BYTE* pbyFNC1, DWORD*
    pdwLength );
```

### Parameters

<i>peDecode</i>	[out]	Pointer to the ITC_CODE128_DECODING location to receive the decoding for Code 128 symbology.
<i>peEan128Ident</i>	[out]	Pointer to the ITC_EAN128_IDENTIFIER location to receive the EAN 128 identifier.
<i>peCip128State</i>	[out]	Pointer to the ITC_CODE128_CIP128 location to receive the CIP 128.
<i>pbyFNC1</i>	[out]	Pointer to the BYTE location to receive the FNC1 separator character.
<i>pdwLength</i>	[out]	Pointer to the DWORD location to receive a value for bar code length.

### Return Values

HRESULT that indicates success or failure.

### Remarks

None.

### See Also

None.



**IS9CConfig::SetCode128**

This function updates the Code 128 settings with new values.

**Syntax**

```
HRESULT IS9CConfig::SetCode128( ITC_CODE128_DECODING
eDecode, ITC_EAN128_IDENTIFIER eEan128Ident,
ITC_CODE128_CIP128 eCip128State, BYTE byFNC1, DWORD dwLength
);
```

**Parameters**

<i>eDecode</i>	[in]	Identifies the decoding for Code 128 symbology.
<i>eEan128Ident</i>	[in]	Identifies the EAN 128 identifier.
<i>eCip128State</i>	[in]	Identifies the CIP 128.
<i>byFNC1</i>	[in]	Identifies the FNC1 separator character, usually any ASCII value.
<i>dwLength</i>	[in]	Identifies the bar code length.

**Return Values**

HRESULT that indicates success or failure.

**Remarks**

None.

**See Also**

None.

**Code 128/EAN 128 Default Settings**

Parameter	Default	Valid Range
Decoding	Not Active	ITC_CODE128_DECODING
EAN 128 Identifier	Include ]C1	ITC_EAN128_IDENTIFIER
CIP 128 French Pharmaceutical Codes	Not Active	ITC_CODE128_CIP128
FNC1 Separator Character (EAN 128 norms)	GS function Char ASCII 29 or 0x1D	0x00`0xFE ITC_CODE128_FNC1_NO_CHANGE
Bar Code Length	Any Bar Code Length	0x00`0xFE ITC_BC_LENGTH_NO_CHANGE