

**GARMIN®**

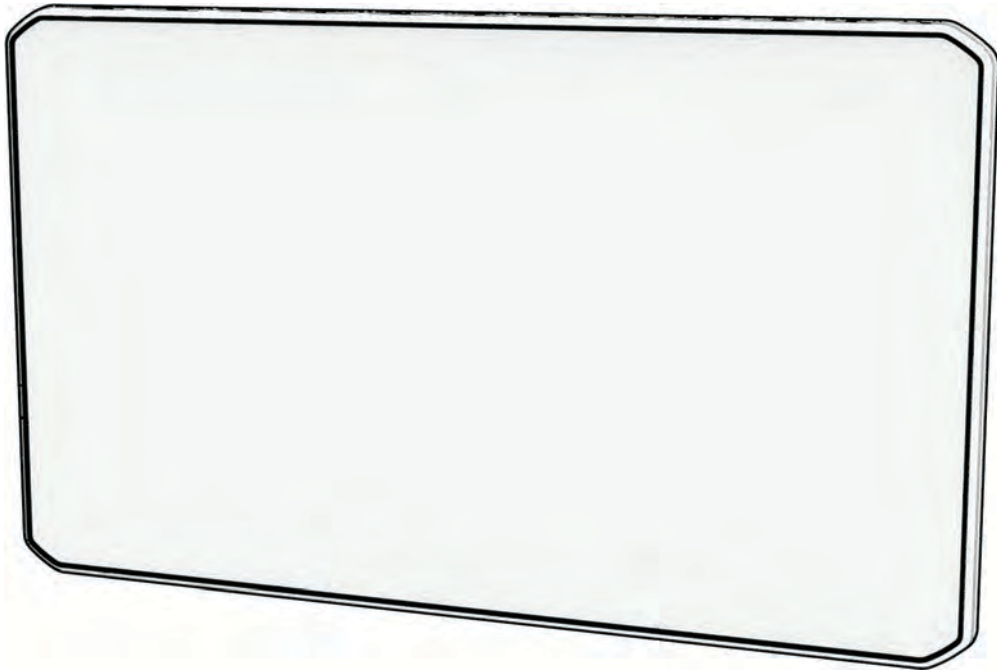

# **DĚZLCAM™ OTR710 / LGV710**

---

**Owner's Manual**

© 2022 Garmin Ltd. or its subsidiaries

All rights reserved. Under the copyright laws, this manual may not be copied, in whole or in part, without the written consent of Garmin. Garmin reserves the right to change or improve its products and to make changes in the content of this manual without obligation to notify any person or organization of such changes or improvements. Go to [www.garmin.com](http://www.garmin.com) for current updates and supplemental information concerning the use of this product.

Garmin® and the Garmin logo are trademarks of Garmin Ltd. or its subsidiaries, registered in the USA and other countries. These trademarks may not be used without the express permission of Garmin.

dēzlCam™, Garmin eLog™, Garmin Express™, and myTrends™ are trademarks of Garmin Ltd. or its subsidiaries. These trademarks may not be used without the express permission of Garmin.

Android™ is a trademark of Google LLC. Apple®, iPhone®, and Mac® are trademarks of Apple Inc, registered in the U.S. and other countries. The BLUETOOTH® word mark and logos are owned by the Bluetooth SIG, Inc. and any use of such marks by Garmin is under license. Love's® and Love's Travel Stops® are registered trademarks of Love's Travel Stops & Country Stores, Inc. microSD® and the microSDHC logo are trademarks of SD-3C, LLC. Pilot Flying J™ and Pilot Flying J Travel Centers™ are trademarks of Pilot Travel Centers LLC and its affiliate companies. PrePass® is a trademark of the PrePass Safety Alliance. Tripadvisor® is a registered trademark of TripAdvisor LLC. TruckDown® is the trademark of TruckDown Info International, Inc. Wi-Fi® is a registered mark of Wi-Fi Alliance Corporation. Windows® is a registered trademark of Microsoft Corporation in the United States and other countries.

# Table of Contents

<b>Getting Started.....</b>	<b>1</b>
dēzlCam Device Overview.....	1
Installing the Dash Camera Memory Card.....	2
Mounting Considerations.....	2
Mounting and Powering the dēzlCam Device in Your Vehicle.....	3
Turning the Device On or Off.....	6
Acquiring GPS Signals.....	6
Status Bar Icons.....	7
Using the On-Screen Buttons.....	7
Adjusting the Volume.....	7
Using the Audio Mixer.....	8
Enabling or Disabling Sounds and Audio Sources.....	8
Adjusting the Screen Brightness.....	8
<b>Vehicle Profiles.....</b>	<b>8</b>
Adding a Vehicle Profile.....	8
Adding an Environmental Zone Vehicle Profile.....	9
Car Profile.....	9
Switching the Vehicle Profile.....	9
Changing Your Trailer Information.....	9
Editing a Vehicle Profile.....	9
<b>Dash Cam.....</b>	<b>10</b>
Aligning the Camera.....	10
Dash Cam Recording.....	10
Saving a Dash Cam Recording.....	10
Stopping or Starting Dash Camera Recording.....	10
Turning Audio Recording On or Off..	11
Viewing Videos and Photos.....	11
Videos on Your Computer.....	11
Deleting a Video or Photo.....	11
Vault Storage.....	11
Upgrading Your Vault Subscription..	11
Sharing a Video.....	12
Editing and Exporting a Video.....	12
Disabling a Shared Video Link.....	12
Removing a Video from the Vault....	12
<b>Driver Awareness Features and Alerts.....</b>	<b>13</b>
Enabling or Disabling Driver Alerts.....	13
Red Light and Speed Cameras.....	14
Advanced Driver Assistance System... ..	14
Forward Collision Warning System..	14
Lane Departure Warning System.....	15
<b>Finding and Saving Locations.....</b>	<b>16</b>
Finding a Location Using the Search Bar.....	17
Finding an Address.....	17
Location Search Results.....	18
Changing the Search Area.....	19
Points of Interest.....	19
Finding Trucking Points of Interest..	19
Finding TruckDown® Points of Interest.....	19
Finding a Location by Category.....	20
Tripadvisor.....	20
Navigating to Points of Interest Within a Venue.....	20
Custom Points of Interest.....	20
Installing POI Loader.....	21
Finding Custom POIs.....	21
Search Tools.....	21
Finding an Intersection.....	21
Finding a Location Using Coordinates.....	21
Parking.....	21
Finding Truck Parking.....	21
Finding Truck Parking in Europe.....	21
Finding Parking Near Your Current Location.....	22
Finding Parking Near a Specified Location.....	22
Viewing Recently Found Locations.....	22
Clearing the List of Recently Found Locations.....	22
Viewing Current Location Information.....	22
Finding Emergency Services and Fuel.....	22
Getting Directions to Your Current Location.....	22
Saving Locations.....	23
Saving a Location.....	23
Saving Your Current Location.....	23
Editing a Saved Location.....	23

Assigning Categories to a Saved Location.....	23	Restriction Warnings.....	33
Deleting a Saved Location.....	23	Road Condition Warnings.....	33
<b>Navigating to Your Destination.....</b>	<b>24</b>	Alerts.....	34
Routes.....	24	Trip Information.....	34
Starting a Route.....	24	Viewing Trip Data from the Map.....	34
Starting a Route by Using the Map...	24	Viewing the Trip Information Page..	34
Going Home.....	24	Resetting Trip Information.....	35
Your Route on the Map.....	25	Viewing Upcoming Traffic.....	35
Viewing Popular Truck Paths on the Map.....	26	Viewing Traffic on the Map.....	35
Active Lane Guidance.....	26	Searching for Traffic Incidents.....	35
Viewing Turns and Directions.....	26	Customizing the Map.....	35
Viewing the Entire Route on the Map.....	26	Customizing the Map Layers.....	35
Planning Your Arrival.....	26	Changing the Map Data Field.....	35
Arriving at Your Destination.....	27	Changing the Map Perspective.....	36
Completing a Truck Route.....	27	<b>Live Services, Traffic, and Smartphone Features.....</b>	<b>36</b>
Parking Near Your Destination.....	28	Pairing with Your Smartphone.....	36
Changing Your Active Route.....	28	Disabling Bluetooth Features (Android™).....	36
Adding a Location to Your Route.....	28	Disabling Bluetooth Features (iPhone®).....	37
Shaping Your Route.....	28	Viewing Videos and Photos on Your Smartphone.....	37
Taking a Detour.....	28	Deleting a Video or Photo Using Your Smartphone.....	37
Changing the Route Calculation Mode.....	29	Bluetooth Feature Status Icons.....	37
Stopping the Route.....	29	Smart Notifications.....	38
Using Suggested Routes.....	29	Receiving Notifications.....	38
Avoiding Delays, Tolls, and Areas.....	29	Viewing the List of Notifications.....	39
Avoiding Traffic Delays on Your Route.....	29	Going to an Address or Location Using the dēzl App.....	39
Avoiding Road Features.....	29	Hands-Free Calling.....	39
Avoiding Environmental Zones On Your Route.....	29	Placing a Call.....	39
Custom Avoidances.....	29	Receiving a Call.....	40
<b>Using the Map.....</b>	<b>30</b>	Using the Call History.....	40
Map Tools.....	31	Using In-Call Options.....	40
Viewing a Map Tool.....	31	Saving a Home Phone Number.....	40
Up Ahead.....	31	Deleting a Paired Phone.....	41
Viewing Upcoming Locations.....	32	<b>Traffic.....</b>	<b>41</b>
Customizing the Up Ahead Categories.....	32	Receiving Traffic Data Using Your Smartphone.....	41
Cities Ahead.....	32	Enabling Traffic.....	41
Viewing Upcoming Cities and Exit Services.....	32	Viewing Traffic on the Map.....	41
Warning and Alert Symbols.....	32	Searching for Traffic Incidents.....	41

<b>Vehicle and Driver Tools.....</b>	<b>42</b>		
Break Planning.....	42		
Taking a Suggested Break.....	42		
Starting the Break Timer.....	42		
Pausing and Resetting the Break Timer.....	42		
Adjusting Drive Hours.....	42		
Adjusting the Daily Driving Limit.....	42		
Garmin eLog.....	43		
Setting Up Garmin eLog Features On Your dēzl Device.....	43		
Viewing Garmin eLog Information on Your dēzl Device.....	43		
Viewing Garmin eLog Diagnostic and Malfunction Events.....	43		
IFTA.....	43		
Entering Fuel Data.....	44		
Editing Fuel Data.....	44		
Viewing and Exporting a Jurisdiction Summary.....	44		
Editing and Exporting Trip Reports..	44		
Viewing Exported Jurisdiction Summaries and Trip Reports.....	45		
Logging Service History.....	45		
Adding Service Categories.....	45		
Deleting Service Categories.....	45		
Renaming Service Categories.....	45		
Deleting Service Records.....	45		
Editing a Service Record.....	46		
PrePass®.....	46		
Loyalty Programs.....	46		
<b>Using the Apps.....</b>	<b>46</b>		
Viewing the Owner's Manual on Your Device.....	46		
Viewing the Weather Forecast.....	46		
Viewing Weather Near a Different City.....	46		
Viewing the Weather Radar.....	47		
Viewing Weather Alerts.....	47		
Checking Road Conditions.....	47		
Route Planner.....	47		
Planning a Route.....	47		
Editing and Reordering Locations in a Route.....	48		
Changing Routing Options for a Route.....	48		
Navigating to a Saved Route.....	48		
Editing and Saving Your Active Route.....	48		
photoLive Traffic Cameras.....	48		
Viewing and Saving photoLive Traffic Cameras.....	49		
Viewing photoLive Traffic Cameras on the Map.....	49		
Saving a Traffic Camera.....	49		
Wireless Cameras.....	49		
Pairing the BC 40 Camera with a Garmin Navigation Device.....	49		
Pairing a BC 50 Camera with a Garmin Navigation Device.....	50		
Viewing the Backup Camera.....	50		
Viewing Previous Routes and Destinations.....	51		
Music Player.....	52		
Adding the Music Player Tool to the Map.....	52		
Garmin PowerSwitch™ App.....	53		
Activating a Power Switch.....	53		
Turning Off All Switches.....	53		
Customizing a Button.....	54		
Assigning a Switch to a Control Input.....	54		
Adding a Custom Layout.....	54		
Routines.....	55		
<b>Voice Command.....</b>	<b>56</b>		
Tips for Speaking to the Device.....	56		
Launching Garmin Voice-Activated Navigation.....	57		
Controlling the Camera Using Voice Commands.....	57		
Checking Your Arrival Time.....	57		
Placing a Phone Call Using Your Voice.....	57		
Changing Device Settings Using Your Voice.....	57		
<b>Settings.....</b>	<b>57</b>		
Map and Vehicle Settings.....	57		
Enabling Maps.....	58		
Navigation Settings.....	58		
Calculation Mode Settings.....	58		
Setting a Simulated Location.....	58		
Wireless Network Settings.....	59		

Driver Assistance Settings.....	59	Transferring Data From Your Computer.....	67
Proximity Alerts Settings.....	59	Disconnecting the USB Cable.....	67
Dash Cam Settings.....	60	<b>Troubleshooting.....</b>	<b>67</b>
Backup Camera Settings.....	60	My video recordings are blurry.....	67
Display Settings.....	60	My memory card has degraded and needs to be replaced.....	68
Traffic Settings.....	60	My video recordings are choppy or incomplete.....	68
Units and Time Settings.....	60	The suction cup will not stay on my windshield.....	68
Setting the Time.....	61	My device is not acquiring satellite signals.....	68
Language and Keyboard Settings.....	61	The device does not charge in my vehicle.....	68
Device and Privacy Settings.....	61	My battery does not stay charged for very long.....	69
Resetting Data and Settings.....	61	My device does not connect to my phone.....	69
<b>Device Information.....</b>	<b>61</b>	<b>Appendix.....</b>	<b>69</b>
Viewing E-label Regulatory and Compliance Information.....	61	Installing a Memory Card for Maps and Data.....	69
Specifications.....	62	Viewing GPS Signal Status.....	69
Charging the Device.....	62	Purchasing Additional Maps.....	69
<b>Device Maintenance.....</b>	<b>62</b>	Purchasing Accessories.....	69
Garmin Support Center.....	62	European Emission Standards.....	69
Map and Software Updates.....	62	Garmin PowerSwitch.....	70
Connecting to a Wi-Fi Network.....	62	Mounting Considerations.....	70
Updating Maps and Software Using a Wi-Fi Network.....	63	Mounting the Device.....	70
Updating Maps and Software with Garmin Express.....	64	Opening the Front Cover.....	71
Device Care.....	65	Connecting Accessories.....	72
Cleaning the Outer Casing.....	65	Connecting a Control Input.....	73
Cleaning the Touchscreen.....	65	Connecting the Device to Vehicle Power.....	73
Cleaning the Camera Lens.....	66	Pairing with a Garmin Navigation Device.....	74
Avoiding Theft.....	66	Garmin PowerSwitch Specifications.....	74
Restarting the Device.....	66	Troubleshooting.....	74
Removing the Device, Mount, and Suction Cup.....	66	<b>Data Management.....</b>	<b>66</b>
Removing the Device from the Mount.....	66	About Memory Cards.....	66
Removing the Mount from the Suction Cup.....	66	Formatting the Dash Cam Memory Card.....	67
Removing the Suction Cup from the Windshield.....	66	Connecting the Device to Your Computer.....	67

# Getting Started

## ⚠ WARNING

See the *Important Safety and Product Information* guide in the product box for product warnings and other important information.

- Update the maps and software on your device ([Map and Software Updates](#), page 62).
- Mount the device in your vehicle and connect it to power ([Mounting Considerations](#), page 2).
- Acquire GPS signals ([Acquiring GPS Signals](#), page 6).
- Adjust the volume ([Adjusting the Volume](#), page 7) and display brightness ([Adjusting the Screen Brightness](#), page 8).
- Set up a vehicle profile ([Adding a Vehicle Profile](#), page 8).
- Navigate to your destination ([Starting a Route](#), page 24).

## dēzlCam Device Overview



①	Microphone for Voice Command or hands-free calling
②	Power button
③	USB power and data port
④	Camera memory card slot
⑤	Map and data memory card slot

## Installing the Dash Camera Memory Card

Before the device can record video from the integrated dash camera, you must install a camera memory card. The camera requires a microSD® memory card from 4 to 256 GB with a speed rating of Class 10 or higher. You can use the included memory card, or you can purchase a compatible memory card from an electronics supplier.

**NOTE:** A memory card is included so your device is ready to use out of the box. All memory cards have a limited life and must be replaced periodically. Your device alerts you when the memory card has exceeded its useful life and needs to be replaced. You can follow the troubleshooting tips to help extend the useful life of the memory card (*My memory card has degraded and needs to be replaced*, page 68).

- 1 Insert a memory card ① into the camera memory card slot ②.

**NOTE:** If you install the memory card into the incorrect slot, the camera cannot record video.



- 2 Press it in until it clicks.

## Mounting Considerations

- Do not mount the device in a location that obscures the driver's view of the road.

### ⚠ WARNING

It is your responsibility to ensure the mounting location complies with all applicable laws and ordinances, and does not block your view of the road during the safe operation of your vehicle.

- Choose a location that allows you to route the power cable safely.

### ⚠ WARNING

When installing the device in a vehicle, install the device and power cable securely so they do not interfere with the vehicle operating controls. Interference with the vehicle operating controls can result in a collision, which could result in injury or death.

- Choose a location that is within easy reach.
- Choose a location that provides the dash cam with a clear view of the road.  
You should verify the vehicle's windshield wipers clear the windshield area in front of the dash cam, and you should avoid placing the dash cam behind a tinted area of the windshield.
- Thoroughly clean the windshield before installing the mount.



## Mounting and Powering the dēzlCam Device in Your Vehicle

### **WARNING**

This product contains a lithium-ion battery. To prevent the possibility of personal injury or product damage caused by battery exposure to extreme heat, store the device out of direct sunlight.

Before you use your device on battery power, you should charge it.

- 1 Press the suction cup to the windshield, and flip the lever  back toward the windshield.



- 2 Plug the vehicle power cable into the USB port  on the device.



- 3 Plug the other end of the vehicle power cable ③ into a power outlet in your vehicle.
- 4 Fit the tab on the bottom of the mount into the slot ④ on the back of the device, and press the device into the mount until it clicks.



## Turning the Device On or Off

- To turn the device on, press the power button ①, or connect the device to power.



- To put the device in power saving mode, press the power button while the device is on. While in power saving mode, the screen is off and the device uses very little power, but it can wake instantly for use.  
**TIP:** You can charge your device faster by putting it in power saving mode while charging the battery.
- To turn off the device completely, hold the power button until a prompt appears on the screen, and select **Off**. The prompt appears after five seconds. If you release the power button before the prompt appears, the device enters power saving mode.

## Acquiring GPS Signals









When you turn on your navigation device, the GPS receiver must collect satellite data and establish the current location. The time required to acquire satellite signals varies based on several factors, including how far you are from the location where you last used your navigation device, whether you have a clear view of the sky, and how long it has been since you last used your navigation device. The first time you turn on your navigation device, it may take several minutes to acquire satellite signals.

- 1 Turn on the device.
- 2 Wait while the device locates satellites.
- 3 If necessary, go to an open area, away from tall buildings and trees.

▬▬▬▬ in the status bar indicates the satellite signal strength. When at least half the bars are filled, the device is ready for navigation.







## Status Bar Icons

The status bar is located at the top of the main menu. The status bar icons display information about features on the device. You can select some icons to change settings or view additional information.



	GPS signal status. Hold to view GPS accuracy and acquired satellite information ( <a href="#">Viewing GPS Signal Status, page 69</a> ).
	Bluetooth® technology status. Select to view the Bluetooth settings ( <a href="#">Wireless Network Settings, page 59</a> ).
	Wi-fi signal strength. Select to change the wi-fi settings ( <a href="#">Wireless Network Settings, page 59</a> ).
	Connected to hands-free calling. Select to place a phone call ( <a href="#">Hands-Free Calling, page 39</a> ).
	Active vehicle profile. Select to view the vehicle profile settings ( <a href="#">Editing a Vehicle Profile, page 9</a> ).
	Garmin eLog™ status. Select to view the current ELD information. When the icon is blue, the device is connected to the Garmin eLog app.
<b>9:10</b>	Current time. Select to set the time ( <a href="#">Setting the Time, page 61</a> ).
	Battery charge level.
	dēzl™ app connection status( <a href="#">Pairing with Your Smartphone, page 36</a> ).
<b>53° F</b>	Temperature. Select to view the weather forecast ( <a href="#">Viewing the Weather Forecast, page 46</a> ).
	Dash cam recording status. Select to open the dash cam controls.

## Using the On-Screen Buttons

On-screen buttons allow you to navigate the pages, menus, and menu options on your device.

- Select  to return to the previous menu screen.
- Hold  to quickly return to the main menu.
- Select  or  to scroll through lists or menus.
- Hold  or  to scroll faster.
- Select  to see a context-based menu of options for the current screen.

## Adjusting the Volume

- 1 Select .
- 2 Select an option:
  - Use the slider bar to adjust the volume.
  - Select  to mute the device.
  - Select a check box to enable or disable additional sound options.

## Using the Audio Mixer

You can use the audio mixer to set the volume levels for different audio types, such as navigation prompts or phone calls. The level for each audio type is a percentage of the master volume.

- 1 Select .
- 2 Select **Mixer**.
- 3 Use the sliders to adjust the volume for each audio type.

## Enabling or Disabling Sounds and Audio Sources

You can turn specific audio sources and system sounds on or off without affecting other audio sources.

- 1 Select .
- 2 In the **Sounds** section, select an option:
  - To enable the device to speak navigation prompts and directions, select the **Spoken Navigation** check box.
  - To enable the device to speak traffic alerts and prompts, select the **Spoken Traffic Alerts** check box.
  - To enable the device to play a tone when a driver awareness alert is triggered, select the **Alerts and Tones** check box.
  - To enable the device to play a sound when you touch on-screen buttons, select the **Button Presses** check box.

## Adjusting the Screen Brightness

- 1 Select  > **Display** > **Brightness**.
- 2 Use the slider bar to adjust the brightness.

# Vehicle Profiles

### **WARNING**



Entering your vehicle profile characteristics does not guarantee that your vehicle's characteristics will be accounted for in all route suggestions or that you will receive the warning icons in all cases. Limitations may exist in the map data such that your device cannot account for these restrictions or road conditions in all cases. Always defer to all posted road signs and road conditions when making driving decisions.

Routing and navigation are calculated differently based on your vehicle profile. The activated vehicle profile is indicated by an icon in the status bar. The navigation and map settings on your device can be customized separately for each vehicle type.

When you activate a truck vehicle profile, the device avoids including restricted or impassable areas in routes based on the dimensions, weight, and other characteristics you entered for your vehicle.

## Adding a Vehicle Profile

You can add a vehicle profile that includes the weight, dimensions, and other characteristics for your vehicle.

- 1 Select  > **Vehicle Profile** > .
- 2 Select an option:
  - To add a straight truck with a permanently attached cargo area, select **Straight Truck**.
  - To add a tractor or a tractor-trailer combination, select **Tractor**.
  - To add a bus, select **Bus**.
- 3 Follow the on-screen instructions to enter the vehicle characteristics.

After you add a vehicle profile, you can edit the profile to enter additional detailed information, such as the vehicle identification number or trailer number ([Editing a Vehicle Profile, page 9](#)).

## Adding an Environmental Zone Vehicle Profile

You can add a vehicle profile for the environmental zone settings specific to your vehicle, such as fuel type and emission standard.

**NOTE:** This feature is not available for all regions or product models.



- 1 Select  > **Navigation** > **Environmental Zones**.
- 2 Follow the on-screen instructions.

## Car Profile

The car profile is a preloaded vehicle profile intended for use in an automobile without a trailer. While using the car profile, the device calculates standard automobile routes, and routing for large vehicles is not available. Some features and settings specific to large vehicles are not available while using the car profile.

## Switching the Vehicle Profile

Each time you turn on your device, it prompts you to select a vehicle profile. You can manually switch another vehicle profile at any time.

- 1 From the status bar, select the vehicle profile icon, such as  or .
- 2 Select a vehicle profile.  
The vehicle profile information appears, including measurements and weight.
- 3 Select **Select**.

## Changing Your Trailer Information







Before you can change your trailer information, you must enter a vehicle profile for a tractor ([Adding a Vehicle Profile, page 8](#)).

When you change the trailer on your tractor, you can change the trailer information in your vehicle profile without changing the tractor information. You can switch quickly between frequently used trailers.

- 1 From the home screen, select the vehicle profile widget.
- 2 Select the tractor vehicle profile to use with the trailer.
- 3 Select .
- 4 Select an option:
  - To use a recent trailer configuration, select a trailer configuration from the list.
  - To enter a new trailer configuration, select **New Configuration**, and enter the trailer information.

## Editing a Vehicle Profile

You can edit a vehicle profile to change vehicle information or to add detailed information to a new vehicle profile, such as the vehicle identification number, trailer number, or odometer reading. You can also rename or delete a vehicle profile.

- 1 Select  > **Vehicle Profile**.
- 2 Select the vehicle profile to edit.
- 3 Select an option:
  - To edit the vehicle profile information, select , and select a field to edit.
  - To rename a vehicle profile, select  >  > **Rename Profile**.
  - To delete the vehicle profile, select  >  > **Delete**.

# Dash Cam

## Aligning the Camera

### WARNING

Do not attempt to align the camera while driving because doing so can cause distraction that could lead to an accident resulting in serious personal injury or death.

Advanced driver assistance features may not perform properly if the camera is not aligned. You should align the dash camera each time you mount or reposition the device.

- 1 Select  > **Dash Cam** > **Camera Placement**.
- 2 Select **Horizontal Placement**, and select the horizontal location of your device on the windshield.
- 3 Select **Vehicle Height**, and select your vehicle type.
- 4 Select **Alignment**.
- 5 Tilt the device and turn the camera left or right to align the camera.  
The crosshairs should point straight ahead, and the horizon line should be centered between the top and bottom of the screen.

## Dash Cam Recording

### NOTICE

Some jurisdictions may prohibit or regulate recording audio and video, or taking photographs. Jurisdictions may require that all parties have knowledge of the recording and provide consent before you record audio and video or take photographs. It is your responsibility to know and comply with all laws, regulations, and any other restrictions in your jurisdiction.



The dash cam records video to the camera memory card. By default, the device immediately starts recording video when it turns on, and it continues recording until it is turned off. If the memory card is full, the device automatically deletes the oldest unsaved video to create space for new video.

When the option to promptly delete unsaved video is enabled, the device continually deletes unsaved video more than three minutes old and deletes all unsaved video each time it is powered off. You can enable or disable this feature in the camera settings ([Dash Cam Settings, page 60](#)).



You can save a video recording to prevent it from being overwritten or deleted.

## Saving a Dash Cam Recording

You can save a portion of the recorded video to prevent it from being overwritten by new video. By default, the device uses a sensor to detect possible accidental collisions and saves video footage before, during, and after the detected event. You can also manually save video at any time.

- 1 While the dash cam is recording, select **Dash Cam** > .  
The device saves the video footage before, during, and after you select .
- 2 Select  again to extend the saved recording time (optional).  
A message indicates the video is saving.

## Stopping or Starting Dash Camera Recording

- 1 Select **Dash Cam**.
- 2 Select an option:
  - To stop recording, select .  
**TIP:** By default, recording starts automatically the next time you turn on the device. You can disable this option in the camera settings ([Dash Cam Settings, page 60](#)).
  - To start recording, select .



## Turning Audio Recording On or Off

### NOTICE

Some jurisdictions may prohibit recording audio in the vehicle or may require that all passengers have knowledge of the recording and provide consent before you record audio in the vehicle. It is your responsibility to know and follow all laws and restrictions for your jurisdiction.

The device can record audio using the integrated microphone while recording video. You can turn audio recording on or off at any time.

Select  > **Dash Cam** > **Record Audio**.

## Viewing Videos and Photos

**NOTE:** The device stops recording video while you view videos or photos.

1 Select **Gallery** > **Yes**.

2 Select a video or photo.

The device displays the video or photo. Videos start playing automatically. If the video or photo includes location information, a map shows the location.

## Videos on Your Computer

Media is stored in the DCIM folder on the camera memory card. Videos are stored in MP4 file format. Photos are stored in JPG format. You can view and transfer media by connecting the memory card or the device to your computer ([Connecting the Device to Your Computer, page 67](#)).

The media is sorted into several folders.

**100EVENT:** Contains videos saved automatically when the device detected an incident.

**101PHOTO:** Contains photos.

**102SAVED:** Contains videos saved manually by the user.

**105UNSVD:** Contains unsaved video footage. The device overwrites the oldest unsaved video when the storage space for unsaved video is full.

## Deleting a Video or Photo

1 Select **Gallery** > **Yes**.

2 Select a video or photo.

3 Select  > **Yes**.

## Vault Storage

**NOTE:** This feature is not available for all countries.

You can upload, manage, and share dash camera footage on a secure, online storage drive using the Vault. The dash camera uploads saved videos to the Vault automatically while it is connected to a Wi-Fi® network.

You can store videos in the Vault for up to 24 hours with your dēzl account. There is no size limit to the amount of data you can store. You can purchase an optional Vault subscription from the dēzl app on your smartphone to extend your storage time.

**NOTE:** Your dash camera must be connected to a Wi-Fi network to use this feature.

## Upgrading Your Vault Subscription

You can purchase an optional Vault subscription to extend your storage time.

1 From the dēzl app on your smartphone, select  > **Vault Access** > **Need More Time?**

2 Follow the on-screen instructions.

## Sharing a Video

You can share a secure link to a dash camera video from the Vault.

- 1 From the dēzl app on your smartphone, select **Vault**.
- 2 Select a video, and select **Secure Share**.
- 3 Follow the on-screen instructions.

## Editing and Exporting a Video

You can trim the length of your video to remove unnecessary footage before exporting it to the Vault.

- 1 While viewing a video, drag the trimming handles ① on the video progress bar left or right to trim the video length.

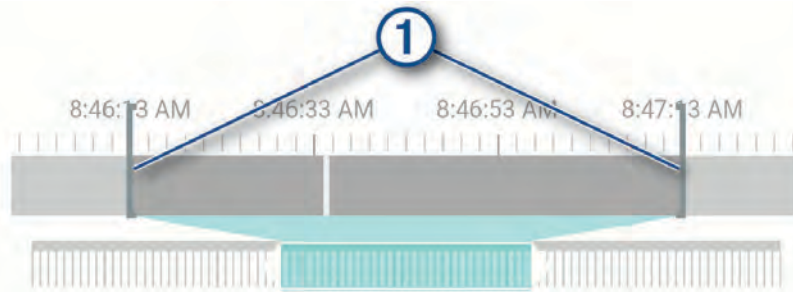

- 2 Select the **Include Audio** check box to include the recorded audio (optional).
- 3 Select **>** or select **Export**.  
**NOTE:** You must keep the app in the foreground while exporting a video.  
The app exports the trimmed video to the Vault and saves the video to your smartphone.
- 4 After the video export is complete, select an option (optional):
  - To remove the video from the camera memory card, select **Remove From Camera**.
  - To return to the gallery, select **>** or select **Done**.

## Disabling a Shared Video Link

You can disable a link to a video that you previously shared from the Vault. When you disable a shared video link, the video is set to private and the shared link and passcode are disabled.

- 1 From the dēzl app on your smartphone, select **Vault**.
- 2 Select a video, and select **Disable Link > Continue**.

## Removing a Video from the Vault

- 1 From the dēzl app on your smartphone, select **Vault**.
- 2 Select a video, and select **Remove From Vault > Continue**.

# Driver Awareness Features and Alerts

## CAUTION

The driver alerts and speed limit features are for information only and do not replace your responsibility to abide by all posted speed limit signs and to use safe driving judgment at all times. Garmin® is not responsible for any traffic fines or citations you receive for failing to follow all applicable traffic laws and signs.

Your device provides features that can help encourage safer driving and increase efficiency, even when you are driving in a familiar area. The device plays an audible tone or message and displays information for each alert. You can enable or disable the audible tone for some types of driver alerts. Not all alerts are available in all areas.

**Schools:** The device plays a tone and displays the speed limit (if available) for an upcoming school or school zone.

**Speed limit exceeded:** The device displays a red border on the speed limit icon when you exceed the posted speed limit for the current road.

**Speed limit reduced:** The device plays a tone and displays the upcoming speed limit so you can be prepared to adjust your speed.

**Wrong way on a one-way street:** The device plays a message and displays a full-screen warning if you travel the wrong way on a one-way street. The edges of the screen appear red and an alert remains at the top of the screen until you leave the one-way street or correct your direction of travel.

**Railroad crossing:** The device displays the distance to an upcoming railroad crossing.

**Animal crossing:** The device plays a tone to indicate an upcoming animal crossing area.

**Curves:** The device plays a tone to indicate a bend in the road.

**Slower traffic:** The device plays a tone to indicate slower traffic when you approach slower traffic at a higher speed. Your device must be receiving traffic information to use this feature ([Traffic, page 41](#)).

**Construction zone:** The device plays a tone and displays a message when you approach a construction zone.

**Lane closure:** The device plays a tone and displays a message when you approach a lane closure.

**Break planning:** The device plays a tone and suggests upcoming rest stops after you have been driving for a long time.

**No trucks allowed:** The device plays a tone when you approach a road where no trucks are allowed.

**Risk of grounding:** The device plays a tone and displays a message when you approach a road where your vehicle could become grounded.

**Lateral wind:** The device plays a tone and displays a message when you approach a road where there is risk of lateral wind.

**Narrow road:** The device plays a tone and displays a message when you approach a road that may be too narrow for your vehicle.

**Steep hill:** The device plays a tone and displays a message when you approach a steep hill.

**State and country borders:** The device plays a tone and displays a message when you approach the border of a state or country.

**Forward collision warning:** The device alerts you when it detects that there is not a safe distance between your vehicle and the vehicle in front of you.

**Lane departure warning:** The device alerts you when it detects you may be crossing a lane boundary unintentionally.

## Enabling or Disabling Driver Alerts

You can enable or disable several types of driver alerts.

- 1 Select  > **Driver Assistance** > **Driver Alerts**.
- 2 Select or clear the check box next to each alert.

## Red Light and Speed Cameras

### NOTICE

Garmin is not responsible for the accuracy of or the consequences of using a red light or speed camera database.

**NOTE:** This feature is not available for all regions or product models.

Information about red light and speed camera locations is available in some areas for some product models. The device alerts you when you approach a reported speed or red light camera.

- In some areas, your device can receive red light and speed camera data while connected to a smartphone running the *dēzl* app.
- You can use the Garmin Express™ software ([garmin.com/express](http://garmin.com/express)) to update the camera database stored on your device. You should update your device frequently to receive the most up-to-date camera information.

## Advanced Driver Assistance System

Your device includes an advanced driver assistance system (ADAS), which uses the integrated dash camera to provide warnings and alerts about your driving environment.

You can enable or disable each of the advanced driver assistance features in the Driver Assistance settings (*Driver Assistance Settings*, page 59).

## Forward Collision Warning System

### ⚠ WARNING

The forward collision warning system (FCWS) feature is for information only and does not replace your responsibility to observe all road and driving conditions, abide by all traffic regulations, and use safe driving judgment at all times. The FCWS relies on the camera to provide a warning of upcoming vehicles and, as a result, may have limited functionality in low visibility conditions. For more information, go to [garmin.com/warnings](http://garmin.com/warnings).

The FCWS feature alerts you when the device detects that there is not a safe distance between your vehicle and the vehicle in front of you. The device determines your vehicle speed using GPS, and it calculates an estimated safe following distance based on your speed. The FCWS activates automatically when your vehicle speed exceeds 65 km/hr (40 mph).

When the device detects that you are too close to the vehicle in front of you, the device plays an audible alert, and a warning appears on the screen.



### Forward Collision Warning System Performance Tips

Several factors affect the performance of the forward collision warning system (FCWS). Some conditions may prevent the FCWS feature from detecting a vehicle in front of you.

- The FCWS feature activates only when your vehicle speed exceeds 65 km/h (40 mph).
- The FCWS feature may not detect a vehicle in front of you when the camera's view of the vehicle is obscured by rain, fog, snow, sun or headlight glare, or darkness.
- The FCWS feature may not function properly if the camera is incorrectly aligned .
- The FCWS feature may not detect vehicles farther away than 40 m (130 ft.) or closer than 5 m (16 ft.).
- The FCWS feature may not function properly if the camera placement settings do not correctly indicate your vehicle height or the placement of your device in the vehicle .

## Lane Departure Warning System

### ⚠ WARNING

The lane departure warning system (LDWS) feature is for information only and does not replace your responsibility to observe all road and driving conditions, abide by all traffic regulations, and use safe driving judgment at all times. The LDWS relies on the camera to provide warnings for lane markers and, as a result, may have limited functionality in low visibility conditions. For more information, go to [garmin.com/warnings](https://garmin.com/warnings).

The LDWS feature alerts you when the device detects you may be crossing a lane boundary unintentionally. For example, the device alerts you if you cross some solid-painted lane boundaries. The LDWS feature provides alerts only when your vehicle speed exceeds 65 km/h (40 mph). The alert appears on the left or right side of the screen to indicate which lane boundary you crossed.

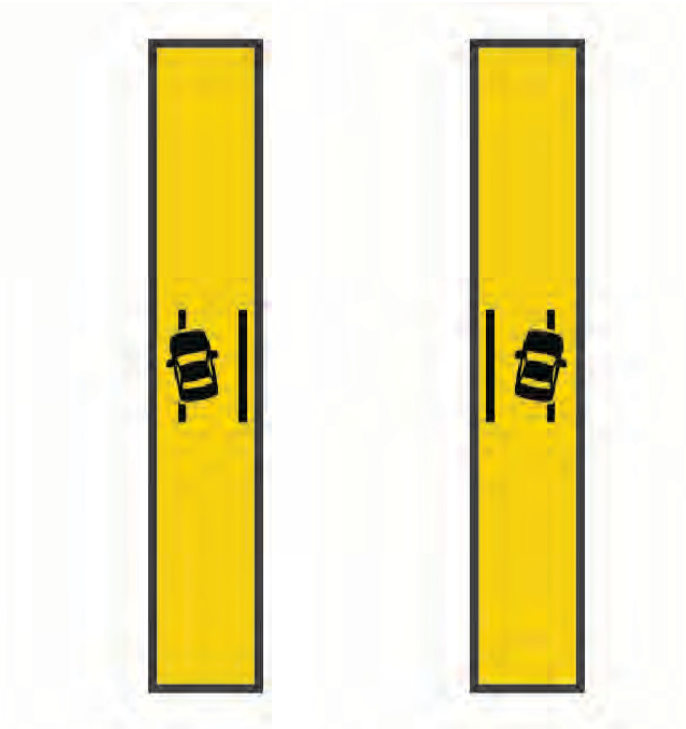

**NOTE:** For the best LDWS performance, you should set the Camera Placement option to indicate the location of the device in your vehicle.

### Setting the Camera Placement

You can mount the device in the left, center, or right of your windshield or dash. For the best LDWS performance, you should set the Camera Placement option to indicate the location of your device in the vehicle.

- 1 Select  > **Dash Cam** > **Camera Placement** > **Horizontal Placement**.
- 2 Select the location of the device.

## Lane Departure Warning Performance Tips

Several factors affect the performance of the lane departure warning system (LDWS). Some conditions may prevent the LDWS feature from detecting lane departures.

- The LDWS feature provides alerts only when your vehicle speed exceeds 65 km/h (40 mph).
- The LDWS feature may not function properly if the camera is incorrectly aligned.
- The LDWS feature may not function properly if the camera placement settings do not correctly indicate your vehicle height or the placement of your device in the vehicle .
- The LDWS feature requires a clear, continuous view of the lane divider lines.
  - Lane departures may not be detected when divider lines are obscured by rain, fog, snow, extreme shadows, sun or headlight glare, road construction, or any other visual obstruction.
  - Lane departures may not be detected if lane divider lines are misaligned, missing, or heavily worn.
- The LDWS feature may not detect lane departures on extremely wide, narrow, or winding roads.

## Finding and Saving Locations

The maps loaded in your device contain locations, such as restaurants, hotels, auto services, and detailed street information. The Where To? menu helps you find your destination by providing several methods to browse, search, and save this information.

From the main menu, select **Where To?**.

- To quickly search all locations on your device, select **Search** (*Finding a Location Using the Search Bar, page 17*).
- To find an address, select **Address** (*Finding an Address, page 17*).
- To browse or search pre-loaded points of interest by category, select **Categories** (*Finding a Location by Category, page 20*).
- To search near a different city or area, select  next to the current search area (*Changing the Search Area, page 19*).
- To view and edit your saved locations, select **Saved** (*Saving Locations, page 23*).
- To view locations you have recently selected from the search results, select **Recent**.
- To search for truck stops and services, select **Categories > Trucking** (*Finding Trucking Points of Interest, page 19*).
- To browse and search Tripadvisor® traveler ratings, select **Tripadvisor**.
- To navigate to specific geographic coordinates, select **Coordinates** (*Finding a Location Using Coordinates, page 21*).

## Finding a Location Using the Search Bar

You can use the search bar to search for locations by entering a category, brand name, address, or city name.

- 1 Select **Where To?**.
- 2 Select **Search** in the search bar.
- 3 Enter all or part of the search term.  
Suggested search terms appear below the search bar.
- 4 Select an option:
  - To search for a type of business, enter a category name (for example, "movie theaters").
  - To search for a business name, enter all or part of the name.
  - To search for an address near you, enter the house number and street name.
  - To search for an address in another city, enter the house number, street name, city, and state.
  - To search for a city, enter the city and state.
  - To search for coordinates, enter latitude and longitude coordinates.
- 5 Select an option:
  - To search using a suggested search term, select the term.
  - To search using the text you entered, select **Q**.
- 6 If necessary, select a location.

## Finding an Address

**NOTE:** The order of the steps may change depending on the map data loaded on your device.

- 1 Select **Where To?**.
- 2 If necessary, select  to search near a different city or area.
- 3 Select **Address**.
- 4 Follow the on-screen instructions to enter address information.
- 5 Select the address.

## Location Search Results

The location search results appear in a list, with the nearest location at the top. Each numbered location also appears on the map. You can scroll down to view more results.

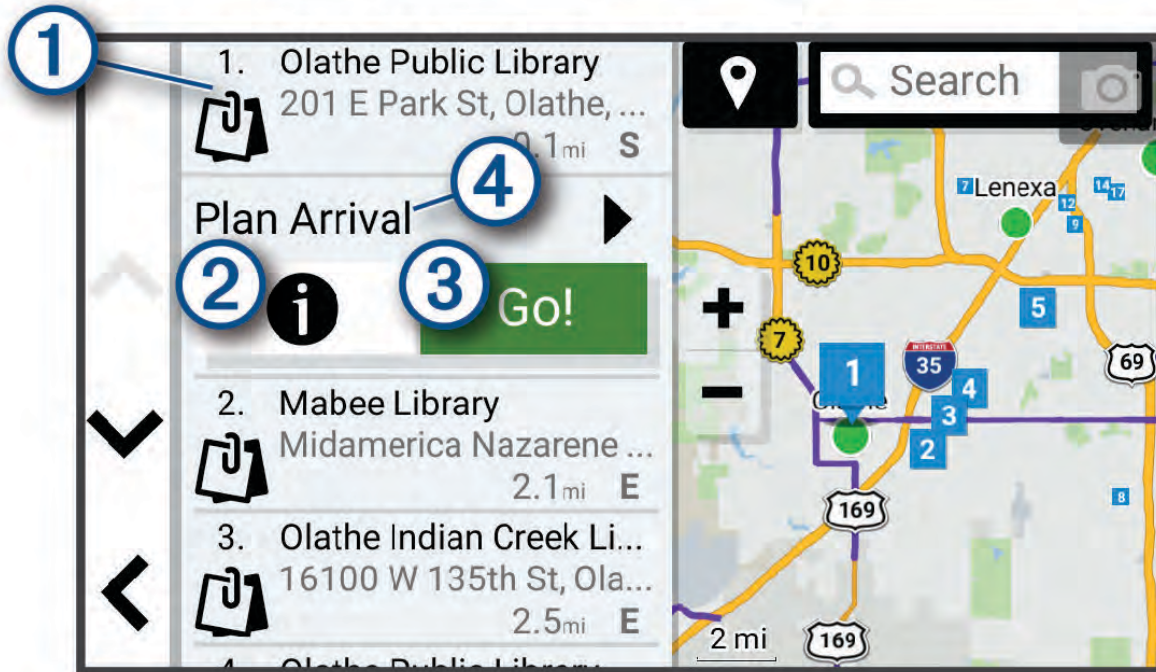



①	Select a location to view the option menu.
② <b>i</b>	Select to view detailed information about the location.
③ Go!	Select to start navigating to the location using the recommended route.
④ Plan Arrival	Select to view a map of your destination and find a truck destination.



## Changing the Search Area

By default, the device searches for locations near your current location. You can also search other areas, such as near your destination, near another city, or along your active route.

- 1 Select **Where To?**.
- 2 Select  next to the current search area .

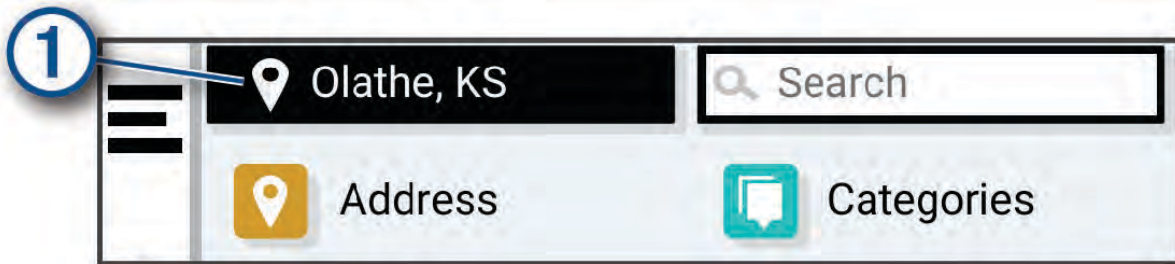

- 3 Select a search area.
- 4 If necessary, follow the on-screen instructions to select a specific location.

The selected search area appears next to . When you search for a location using any of the options in the Where To? menu, the device suggests locations near this area first.

## Points of Interest

### NOTICE

You are responsible for understanding and complying with any applicable rules, laws, or regulations associated with points of interest.

A point of interest is a place that you may find useful or interesting. Points of interest are organized by category and can include popular travel destinations such as gas stations, restaurants, hotels, and entertainment venues.

## Finding Trucking Points of Interest

### NOTICE

You are responsible for understanding and complying with any applicable rules, laws, or regulations associated with points of interest.

The detailed maps loaded in your device contain trucking points of interest, such as truck stops, rest areas, and weigh stations.

Select **Where To?** > **Categories** > **Trucking**.

## Finding TruckDown® Points of Interest

The TruckDown directory lists businesses for the trucking industry such as truck repair and tire sales.

The TruckDown directory is available only in North America.

- 1 Select **Where To?**.
- 2 Select an option:
  - Select **Truck Locations** to find points of interest compatible with trucks.
  - Select **Truck Services** to find service locations for your truck.
- 3 Select a category.
- 4 If necessary, select **Search Filters**, select one or more amenities, and select **Save**.  
**NOTE:** This option is available for truck stops only.
- 5 Select a destination.

## Finding a Location by Category

- 1 Select **Where To?**.
- 2 Select a category, or select **Categories**.
- 3 If necessary, select a subcategory.
- 4 Select a location.

### Searching Within a Category

After you have performed a search for a point of interest, certain categories may display a Quick Search list that shows the last four destinations you selected.

- 1 Select **Where To? > Categories**.
- 2 Select a category.
- 3 Select an option:
  - Select a destination from the quick search list on the right side of the screen.  
The quick search list provides a list of recently found locations in the selected category.
  - Select a subcategory, if necessary, and select a destination.

## Tripadvisor

### NOTICE

Garmin is not responsible for the accuracy or timeliness of the Tripadvisor information.

You are responsible for understanding and complying with any applicable rules, laws, or regulations associated with points of interest.

Your device includes Tripadvisor traveler ratings. Tripadvisor ratings appear automatically in the search results list for restaurants, hotels, and attractions. You can also search for nearby Tripadvisor points of interest and sort by distance or popularity.

### Finding Tripadvisor Points of Interest

- 1 Select **Where To? > Tripadvisor**.
- 2 Select a category.
- 3 If necessary, select a subcategory.  
A list of nearby Tripadvisor points of interest for the category appears.
- 4 Select **Sort Results** to filter the displayed points of interest by distance or popularity (optional).
- 5 Select **Q**, and enter a search term (optional).

### Navigating to Points of Interest Within a Venue

**NOTE:** This feature may not be available in all areas or for all product models.

You can create a route to a point of interest (POI) within a larger venue, such as a store in a shopping mall or a specific terminal in an airport.

- 1 Select **Where To? > Search**.
- 2 Enter the name of the venue, and select **Q**.
- 3 Select the venue.  
A list of categories for POIs within the venue appears.
- 4 Select a category, select a location, and select **Go!**.

The device creates a route to the parking area or venue entrance closest to the POI. When you arrive at the destination, a checkered flag indicates the recommended parking area. A labeled point indicates the location of the POI within the venue.

## Custom Points of Interest

Custom POIs are customized points on the map. They can contain alerts that let you know if you are near a designated point or if you are traveling faster than a specified speed.

## Installing POI Loader

You can create or download custom POI lists on your computer and install them on your device using POI Loader software.

- 1 Go to [www.garmin.com/poiloader](http://www.garmin.com/poiloader).
- 2 Follow the on-screen instructions.

## Finding Custom POIs

Before you can find custom POIs, you must load custom POIs on your device using the POI Loader software (*Installing POI Loader, page 21*).

- 1 Select **Where To? > Categories**.
- 2 Scroll to the Other Categories section, and select a category.

## Search Tools

Search tools allow you to search for specific types of locations by responding to on-screen prompts.

### Finding an Intersection

You can search for an intersection or junction between two streets, highways, or other roads.

- 1 Select **Where To? > Intersections**.
- 2 Follow the on-screen instructions to enter street information.
- 3 Select the intersection.

### Finding a Location Using Coordinates

You can find a location using latitude and longitude coordinates.

- 1 Select **Where To? > Coordinates**.
- 2 If necessary, select , and change the coordinate format or datum.
- 3 Select **Coordinates**.
- 4 Enter the latitude and longitude coordinates, and select **Done**.
- 5 Select an option:
  - To save the coordinates as a location, select **Save**.
  - To start a route to the coordinates, select **Go!**.

## Parking

### Finding Truck Parking

- 1 Select **Where To? > Truck Locations > Parking**.
- 2 If necessary, select **High Capacity Only** to filter locations by parking capacity.
- 3 Select a parking location.
- 4 Select **Go!**.

### Finding Truck Parking in Europe

If you pair your dēzlCam device with the dēzl app and log in to your Truck Parking Europe account, you can view parking availability and ratings on your navigation device.

**NOTE:** This feature is available only in Europe.

- 1 Select **Where To? > Truck Parking Europe**.
- 2 If necessary, select **Search Filters**, select one or more attributes, and select **Search**.
- 3 Select a parking location.
- 4 Select **Go!**.

## Finding Parking Near Your Current Location

- 1 Select **Where To?** > **Categories** > **Parking**.
- 2 Select a parking location.
- 3 Select **Go!**.

## Finding Parking Near a Specified Location

**NOTE:** This feature is available only when you are using the car vehicle profile.

- 1 Select **Where To?**.
- 2 Search for a location.
- 3 From the location search results, select a location.
- 4 Select .  
A list of parking areas near the selected location appears.
- 5 Select a parking location.
- 6 Select **Go!**.

## Viewing Recently Found Locations

Your device stores a history of the last 50 locations you have found.

Select **Where To?** > **Recent**.

## Clearing the List of Recently Found Locations

Select **Where To?** > **Recent** >  > **Clear** > **Yes**.

## Viewing Current Location Information

You can use the **Where Am I?** page to view information about your current location. This feature is helpful if you need to tell emergency personnel your location.

From the map, select the vehicle.

## Finding Emergency Services and Fuel

You can use the **Where Am I?** page to find the nearest hospitals, police stations, and fuel stations.

- 1 From the map, select the vehicle.
- 2 Select **Hospitals**, **Police Stations**, or **Fuel**.  
**NOTE:** When a truck vehicle profile is active, an option for truck stops appears instead of fuel.  
A list of locations for the selected service appears, with the nearest locations at the top.
- 3 Select a location.
- 4 Select an option:
  - To navigate to the location, select **Go!**
  - To view the phone number and other location details, select .

## Getting Directions to Your Current Location

If you need to tell another person how to get to your current location, your device can give you a list of directions.

- 1 From the map, select the vehicle.
- 2 Select  > **Directions to Me**.
- 3 Select a starting location.
- 4 Select **Select**.

## Saving Locations

### Saving a Location

- 1 Search for a location (*Finding a Location by Category*, page 20).
- 2 From the search results, select a location.
- 3 Select **i** > **Save**.
- 4 If necessary, enter a name, and select **Done**.
- 5 Select **Save**.

### Saving Your Current Location

- 1 From the map, select the vehicle icon.
- 2 Select **Save**.
- 3 Enter a name, and select **Done**.

### Editing a Saved Location

- 1 Select **Where To? > Saved**.
- 2 If necessary, select a category.
- 3 Select a location.
- 4 Select **i**.
- 5 Select **≡** > **Edit**.
- 6 Select an option:
  - Select **Name**.
  - Select **Phone Number**.
  - Select **Categories** to assign categories to the saved location.
  - Select **Map Symbol** to change the symbol used to mark the saved location on a map.
- 7 Edit the information.
- 8 Select **Done**.

### Assigning Categories to a Saved Location

You can add custom categories to organize your saved locations.

**NOTE:** Categories appear in the saved locations menu after you have saved at least 12 locations.

- 1 Select **Where To? > Saved**.
- 2 Select a location.
- 3 Select **i**.
- 4 Select **≡** > **Edit > Categories**.
- 5 Enter one or more category names, separated by commas.
- 6 If necessary, select a suggested category.
- 7 Select **Done**.

### Deleting a Saved Location

**NOTE:** Deleted locations cannot be recovered.

- 1 Select **Where To? > Saved**.
- 2 Select **≡** > **Delete**.
- 3 Select the box next to the saved locations to delete, and select **Delete > Yes**.

# Navigating to Your Destination

## Routes

A route is a path from your current location to one or more destinations.

- The device calculates a recommended route to your destination based on the preferences you set, including the route calculation mode ([Changing the Route Calculation Mode, page 29](#)) and avoidances ([Avoiding Delays, Tolls, and Areas, page 29](#)).
- The device can automatically avoid roads that are not appropriate for the active vehicle profile.
- You can start navigating to your destination quickly using the recommended route, or you can select an alternate route ([Starting a Route, page 24](#)).
- If there are specific roads you need to use or avoid, you can customize the route ([Shaping Your Route, page 28](#)).
- You can add multiple destinations to a route ([Adding a Location to Your Route, page 28](#)).

## Starting a Route

- 1 Select **Where To?**, and search for a location ([Finding and Saving Locations, page 16](#)).
- 2 Select a location.
- 3 Select an option:
  - To start navigating using the recommended route, select **Go!**.
  - To choose an alternate route, select **Y**, and select a route.  
Alternate routes appear to the right of the map.
  - To edit the course of the route, select **Y** > **Edit Route**, and add shaping points to the route ([Shaping Your Route, page 28](#)).

The device calculates a route to the location and guides you using voice prompts and information on the map ([Your Route on the Map, page 25](#)). A preview of the major roads in your route appears at the edge of the map for several seconds.

If you need to stop at additional destinations, you can add the locations to your route ([Adding a Location to Your Route, page 28](#)).

## Starting a Route by Using the Map

You can start a route by selecting a location from the map.

- 1 Select **View Map**.
- 2 Drag and zoom the map to display the area to search.
- 3 Select an option:
  - Select a location marker.
  - Select a point, such as a street, intersection, or address location.
- 4 Select **Go!**.

## Going Home

The first time you start a route home, the device prompts you to enter your home location.

- 1 Select **Where To?** > **Go Home**.
- 2 If necessary, enter your home location.

## Editing Your Home Location

- 1 Select **Where To?** >  > **Set Home Location**.
- 2 Enter your home location.

## Your Route on the Map

As you travel, the device guides you to your destination using voice prompts and information on the map. Instructions for your next turn or exit, or other actions appear across the top of the map.



- ① Next action in the route. Indicates the next turn, exit, or other action and the lane in which you should travel, if available.
- ② Distance to the next action.
- ③ Name of the street or exit associated with the next action.
- ④ Route highlighted on the map.
- ⑤ Next action in the route. Arrows on the map indicate the location of upcoming actions.
- ⑥ Vehicle speed.
- ⑦ Name of the road on which you are traveling.
- ⑧ Estimated arrival time.  
**TIP:** You can touch this field to change the information it shows (*Changing the Map Data Field, page 35*).
- ⑨ Map tools. Provides tools to show you more information about your route and surroundings.
- ⑩ Select to toggle popular truck routes on the map.
- ⑪ Select to search for truck stops and other locations along your route.

## Viewing Popular Truck Paths on the Map

You can enable the device to highlight popular truck paths on the map. This can be useful to help you choose roads that are more accessible for your vehicle.

From the map, select .

## Active Lane Guidance

As you approach some turns, exits, or interchanges in your route, a detailed simulation of the road appears beside the map, if available. A colored line  indicates the proper lane for the turn.

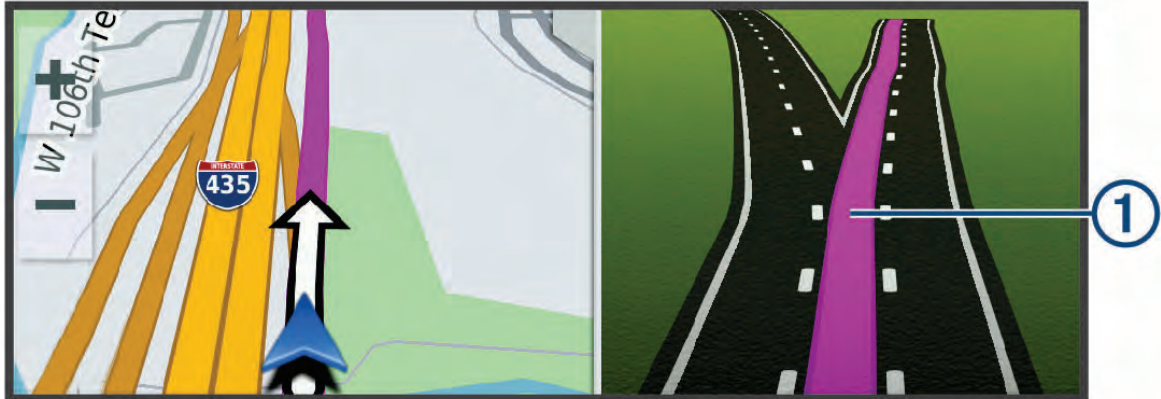

## Viewing Turns and Directions

While navigating a route, you can view upcoming turns, lane changes, or other directions for your route.

1 From the map, select an option:

- To view upcoming turns and directions as you navigate, select  > **Turns**.  
The map tool displays the next several turns or directions beside the map. The list updates automatically as you navigate the route.
- To view the complete list of turns and directions for the entire route, select the text bar at the top of the map.

2 Select a turn or direction (optional).

Detailed information appears. An image of the junction may appear for junctions on major roadways, if available.

## Viewing the Entire Route on the Map

1 While navigating a route, select anywhere on the map.

2 Select .

## Planning Your Arrival

Before you start a route, you can plan to arrive at a popular truck destination, such as a loading dock or truck parking, at the end of your route. You can also add your own destinations to the map.

1 Select **Where To?**, and search for a location (*Finding and Saving Locations, page 16*).

2 Select a location.

3 Select **Plan Arrival**.

A preview of your destination appears on the map. Popular truck destinations appear next to the map. If your dēzlCam device is paired with the dēzl app, it downloads BirdsEye satellite imagery automatically.

4 Select a destination, and select **Go!**.



## Arriving at Your Destination

When you approach your destination, the device provides information to help you complete your route.

- 🚩 indicates the location of your destination on the map, and a voice prompt announces you are approaching your destination.
- When you approach some destinations, the device automatically suggests parking areas. You can select More to view a full list of suggested parking areas ([Parking Near Your Destination, page 28](#)).
- When you approach some destinations while using a truck vehicle profile, the device automatically prompts you to find a truck destination such as a loading dock or truck parking. You can select a suggested point on the map, and then select Go! to navigate to that destination.
- When you stop at your destination, the device automatically ends the route. If the device does not detect your arrival automatically, you can select ☰ > Stop to end your route.

## Completing a Truck Route

When you approach some truck destinations, a map tool appears to help you find common truck destinations such as parking areas and loading docks.

- 1 Select the map tool ①.

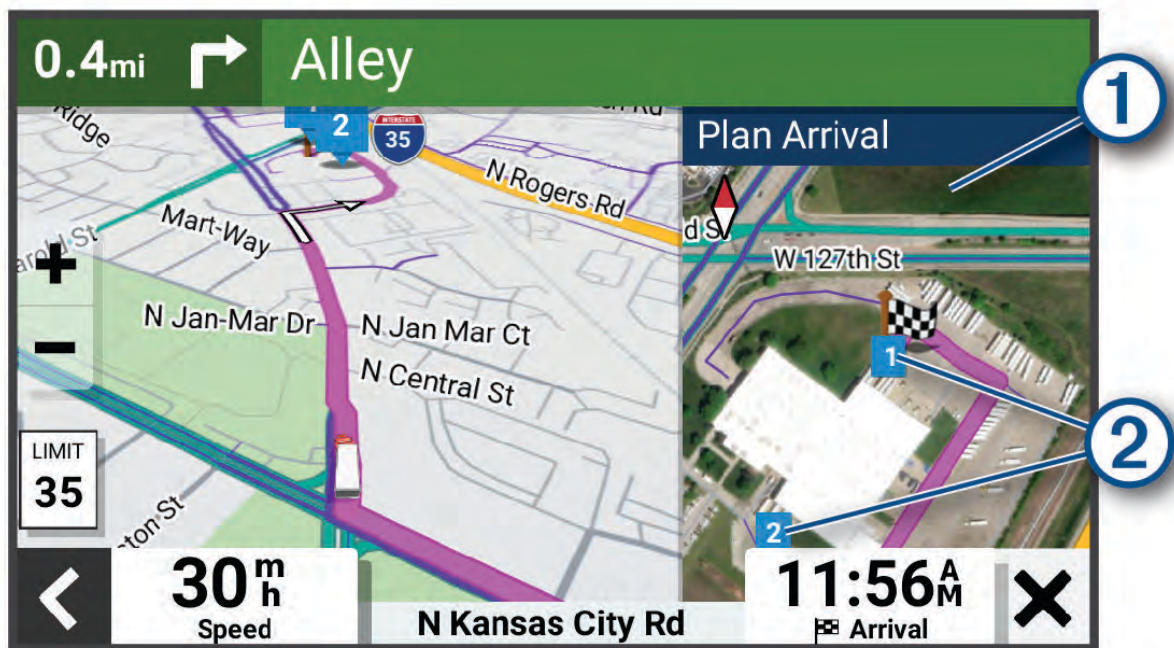

- 2 Touch the map, and select a numbered trucking destination ②.
- 3 Select Go!.

## Parking Near Your Destination

Your device can help you find a parking spot near your destination. When you approach some destinations, the device automatically suggests parking areas.

**NOTE:** This feature should be used only when you are using the car vehicle profile. While using a truck vehicle profile, you can search for truck parking near your destination ([Finding Truck Parking, page 21](#)).

1 Select an option:

- When the device suggests parking, select **More** to see all suggested parking areas.

**NOTE:** When you select a suggested parking area, the device automatically updates your route.

- If the device does not suggest parking locations, select **Where To?** > **Categories** > **Parking**, and select  > **My Destination**.

2 Select a parking location, and select **Go!**.

The device guides you to the parking area.

## Changing Your Active Route

### Adding a Location to Your Route

Before you can add a location to your route, you must be navigating a route ([Starting a Route, page 24](#)).

You can add locations to the middle or end of your route. For example, you can add a fuel station as the next destination in your route.

1 From the map, select  > **Where To?**.

2 Search for a location ([Finding and Saving Locations, page 16](#)).

3 Select a location.

4 Select **Go!**.

5 Select an option:

- To add the location as the next destination in your route, select **Add As Next Stop**.
- To add the location to the end of your route, select **Add As Last Stop**.
- To add the location and edit the order of destinations in your route, select **Add to Active Route**.

The device re-calculates the route to include the added location and guides you to the destinations in order.

### Shaping Your Route

Before you can shape your route, you must start a route ([Starting a Route, page 24](#)).

You can manually shape your route to change its course. This allows you to direct the route to use a certain road or go through a certain area without adding a destination to the route.

1 From the map, select  > **Edit Route** > **Shape Route**.

**TIP:** You can select  to zoom in on the map and select a more precise location.

The device enters route shaping mode and recalculates the route to travel through the selected location.

2 Select  > .

3 If necessary, select an option:

- To add more shaping points to the route, select additional locations on the map.
- To remove a shaping point, select the shaping point and select .

### Taking a Detour

You can take a detour for a specified distance along your route or detour around specific roads. This is useful if you encounter construction zones, closed roads, or poor road conditions.

1 From the map, select  > **Edit Route**.

2 Select an option:

- To detour your route for a specific distance, select **Detour by Distance**.
- To detour around a specific road on the route, select **Detour by Road**.

## Changing the Route Calculation Mode

- 1 Select  > **Navigation** > **Calculation Mode**.
- 2 Select an option:
  - Select **Faster Time** to calculate routes that are faster to drive but can be longer in distance.
  - Select **Straight Line** to calculate point-to-point routes (without roads).

## Stopping the Route

From the map, select  > **Stop**.

## Using Suggested Routes

Before you can use this feature, you must save at least one location and enable the travel history feature ([Device and Privacy Settings, page 61](#)).

Using the myTrends™ feature, your device predicts your destination based on your travel history, the day of the week, and the time of day. After you have driven to a saved location several times, the location may appear in the navigation bar on the map, along with the estimated time of travel, and traffic information.

Select the navigation bar to view a suggested route to the location.

## Avoiding Delays, Tolls, and Areas

### Avoiding Traffic Delays on Your Route

Before you can avoid traffic delays, you must be receiving traffic information.

By default, the device optimizes your route to avoid traffic delays automatically. If you have disabled this option in the traffic settings ([Traffic Settings, page 60](#)), you can view and avoid traffic delays manually.

- 1 While navigating a route, select  > **Traffic**.
- 2 Select **Alternate Route**, if available.
- 3 Select **Go!**.

### Avoiding Road Features

- 1 Select  > **Navigation** > **Avoidances**.
- 2 Select the road features to avoid on your routes, and select **Save**.

### Avoiding Environmental Zones On Your Route

Your device can avoid areas with environmental or emissions restrictions that may apply to your vehicle.

Before you can use this feature, you must add an environmental zone vehicle profile to your device ([Adding an Environmental Zone Vehicle Profile, page 9](#)).

Before you can avoid environmental zones on your route, you must start a route.

**NOTE:** This feature is not available for all regions or product models.

When the device prompts you, select **Go!** to take an alternate route.

### Custom Avoidances

Custom avoidances allow you to select specific areas or sections of road to avoid. When the device calculates a route, it avoids these areas and roads unless no other reasonable route is available.

## Avoiding a Road



- 1 Select  > **Navigation** > **Custom Avoidances**.
- 2 If necessary, select **Add Avoidance**.
- 3 Select **Add Avoid Road**.
- 4 Select the starting point of the section of road to avoid, and select **Next**.
- 5 Select the ending point of the road section, and select **Next**.
- 6 Select **Done**.

## Avoiding an Area



- 1 Select  > **Navigation** > **Custom Avoidances**.
- 2 If necessary, select **Add Avoidance**.
- 3 Select **Add Avoid Area**.
- 4 Select the upper-left corner of the area to avoid, and select **Next**.
- 5 Select the lower-right corner of the area to avoid, and select **Next**.  
The selected area is shaded on the map.
- 6 Select **Done**.

## Disabling a Custom Avoidance

You can disable a custom avoidance without deleting it.





- 1 Select  > **Navigation** > **Custom Avoidances**.
- 2 Select an avoidance.
- 3 Select  > **Disable**.

## Deleting Custom Avoidances

- 1 Select  > **Navigation** > **Custom Avoidances** > .
- 2 Select an option:
  - To delete all custom avoidances, select **Select All** > **Delete**.
  - To delete one custom avoidance, select the avoidance, and select **Delete**.

# Using the Map

You can use the map to navigate a route ([Your Route on the Map, page 25](#)) or to view a map of your surroundings when no route is active.

- 1 Select **View Map**.
- 2 Touch anywhere on the map.
- 3 Select an option:
  - Drag the map to pan left, right, up, or down.
  - To zoom in or out, select  or .
  - To switch between North Up, 2D, and 3D views, select .
  - To open the route planner, select  ([Route Planner, page 47](#)).
  - To start a route, select a location on the map, and select **Go!** ([Starting a Route by Using the Map, page 24](#)).

## Map Tools

Map tools provide quick access to information and device functions while you view the map. When you activate a map tool, it appears in a panel at the edge of the map.

**Stop:** Stops navigation of the active route.

**Camera:** Provides dash cam controls and displays forward collision and lane departure alerts. Also allows you to open the dash cam viewfinder and the driver assistance settings.

**Edit Route:** Allows you to take a detour or skip locations in your route ([Changing Your Active Route, page 28](#)).

**Mute:** Mutes the device audio.

**Cities Ahead:** Displays upcoming cities and services along your active route or along a highway ([Cities Ahead, page 32](#)).

**Up Ahead:** Displays upcoming locations along the route or the road on which you are traveling ([Up Ahead, page 31](#)).

**Elevation:** Displays upcoming elevation changes.

**Traffic:** Displays traffic conditions along your route or in your area ([Viewing Upcoming Traffic, page 35](#)). This feature is not available in all areas or for all device models.

**Trip Data:** Displays customizable trip data, such as speed or mileage ([Viewing Trip Data from the Map, page 34](#)).

**Turns:** Displays a list of upcoming turns in your route ([Viewing Turns and Directions, page 26](#)).

**Phone:** Displays a list of recent phone calls from your connected phone, and displays in-call options while a phone call is active ([Using In-Call Options, page 40](#)).

**Weather:** Displays weather conditions for your area.

**Garmin eLog:** Displays hours of service information from the Garmin eLog app.

**Music Controls:** Displays media controls and media information.

**PrePass®:** Shows notifications for upcoming weigh stations and bypass decisions ([PrePass®, page 46](#)).

**Plan Arrival:** Displays a map of your destination and allows you to find a truck destination.

**Love's:** Displays upcoming Love's Travel Stops® along your route.

**NOTE:** This feature is available only in North America.

**Pilot Flying J:** Displays upcoming Pilot Flying J Travel Centers™ along your route.

**NOTE:** This feature is available only in North America.

**Break Planner:** Displays daily hours driven, total hours driven, and the time to your next break.

## Viewing a Map Tool

1 From the map, select .

2 Select a map tool.

The map tool appears in a panel at the edge of the map.

3 When you are done using the map tool, select .

## Up Ahead

The Up Ahead tool provides information about upcoming locations along your route or the road on which you are traveling. You can view upcoming points of interest by category, such as restaurants, fuel stations, or rest areas.

You can customize the categories that show in the Up Ahead tool.

## Viewing Upcoming Locations

- 1 From the map, select  > **Up Ahead**.

While you are traveling, the map tool shows the next location along your road or route.

- 2 Select an option:

- If the map tool shows categories, select a category to view a list of nearby locations in that category.
- If the map tool shows upcoming locations, select a location to view location details or start a route to the location.

## Customizing the Up Ahead Categories

You can change the location categories that appear in the Up Ahead tool.

- 1 From the map, select  > **Up Ahead**.

- 2 Select a category.

- 3 Select .

- 4 Select an option:

- To move a category up or down in the list, select and drag the arrow next to the category name.
- To change a category, select the category.
- To create a custom category, select a category, select **Custom Search**, and enter the name of a business or category.

- 5 Select **Save**.

## Cities Ahead

While you are traveling on a highway or navigating a route that includes a highway, the Cities Ahead tool provides information about upcoming cities along the highway. For each city, the map tool shows the distance to the highway exit and the services available, similar to the information on highway road signs.

## Viewing Upcoming Cities and Exit Services

- 1 From the map, select  > **Cities Ahead**.

While you are traveling along a highway or an active route, the map tool shows information about upcoming cities and exits.

- 2 Select a city.

The device shows a list of points of interest located at the selected city exit, such as fuel stations, lodging, or restaurants.

- 3 Select a location, and select **Go!** to start navigating.

## Warning and Alert Symbols

### **WARNING**

Entering your vehicle profile characteristics does not guarantee that your vehicle's characteristics will be accounted for in all route suggestions or that you will receive the warning icons in all cases. Limitations may exist in the map data such that your device cannot account for these restrictions or road conditions in all cases. Always defer to all posted road signs and road conditions when making driving decisions.

Warning and alert symbols may appear on the map or in route directions to alert you to potential hazards, road conditions, and upcoming weigh stations.



## Restriction Warnings

	Height
	Weight
	Axle Weight
	Length
	Width
	No Trucks Allowed
	No Trailers Allowed
	Material Restrictions
	No Flammables or Explosives Allowed
	No Water Pollutants Allowed
	No Left Turn
	No Right Turn
	No U Turn

## Road Condition Warnings

	Risk of grounding
	Lateral wind
	Narrow road
	Sharp curve
	Steep down hill
	Steep up hill
	Tree overhang

## Alerts

	Weigh station
	Road not verified for trucks

## Trip Information

### Viewing Trip Data from the Map

Before you can view trip data on the map, you must add the tool to the map tools menu.

From the map, select  > **Trip Data**.



### Viewing Customized Trip Information on the Map

You can use the trip data map tool to show customized trip information on the map.

1 From the map, select  > **Trip Data**.

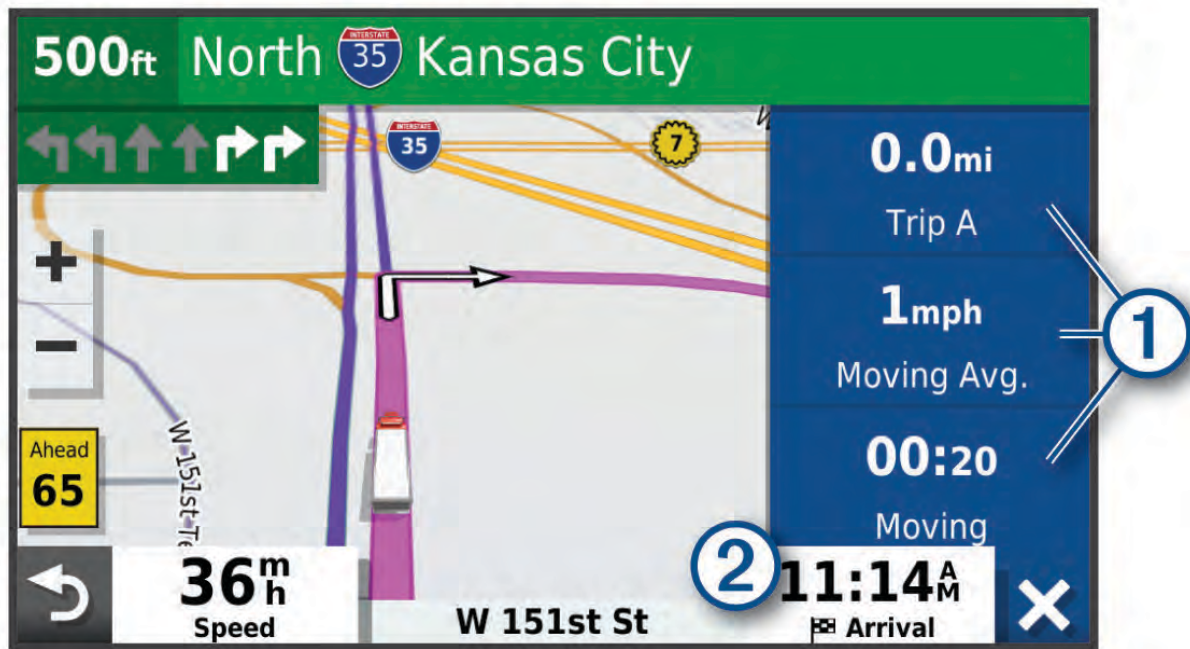
2 Select an option:



- Select a data field in the trip data tool , and select the information to show in the field.
- Select the customizable map data field , and select the information to show in the field.

### Viewing the Trip Information Page

The trip information page displays your speed and provides statistics about your trip.

From the map, select **Speed**.



## Resetting Trip Information

- 1 From the map, select **Speed**.
- 2 Select  > **Reset Field(s)**.
- 3 Select an option:
  - When not navigating a route, select **Select All** to reset every data field except the speedometer, on the first page.
  - Select **Reset Overall Data** to reset Trip A and total data.
  - Select **Reset Trip B** to reset the odometer.
  - Select **Reset Max. Speed** to reset the maximum speed.

## Viewing Upcoming Traffic

### NOTICE

Garmin is not responsible for the accuracy or timeliness of the traffic information.



Before you can use this feature, your device must be receiving traffic data ([Traffic](#), page 41).

You can view traffic incidents coming up along your route or along the road on which you are traveling.



- 1 While navigating a route, select  > **Traffic**.  
The nearest upcoming traffic incident appears in a panel on the right side of the map.
- 2 Select the traffic incident to view additional details.

## Viewing Traffic on the Map

The traffic map shows color-coded traffic flow and delays on nearby roads.

- 1 From the main menu, select  > **Traffic**.
- 2 If necessary, select  > **Legend** to view the legend for the traffic map.

## Searching for Traffic Incidents

- 1 From the main menu, select  > **Traffic**.
- 2 Select  > **Incidents**.
- 3 Select an item in the list.
- 4 If there is more than one incident, use the arrows to view additional incidents.

## Customizing the Map

### Customizing the Map Layers

You can customize which data appear on the map, such as topographic maps and BirdsEye imagery.

- 1 Select  > **Map Display** > **Map Layers**.
- 2 Select the check box next to each layer you want to show on the map.

### Changing the Map Data Field

- 1 From the map, select a data field.  
**NOTE:** You cannot customize Speed.
- 2 Select a type of data to display.

## Changing the Map Perspective

- 1 Select  > **Map Display** > **Driving Map View**.
- 2 Select an option:
  - Select **Track Up** to display the map in two dimensions (2-D), with your direction of travel at the top.
  - Select **North Up** to display the map in 2-D with north at the top.
  - Select **3-D** to display the map in three dimensions.

## Live Services, Traffic, and Smartphone Features

### **WARNING**

Do not read or interact with notifications while driving, because doing so can cause distraction that could lead to an accident resulting in serious personal injury or death.

The dēzl app allows your device to receive smart notifications and live information, such as live traffic data and weather information.

**Live traffic data:** Sends real-time traffic data to your device, such as traffic incidents and delays, construction zones, and road closings ([Traffic](#), page 41).

**Weather information:** Sends real-time weather forecasts, road conditions, and weather radar to your device ([Viewing the Weather Forecast](#), page 46).

**Hands-Free calling:** Allows you to place and receive phone calls using your device, and allows you to use the device as a hands-free speaker phone.

**Send locations to device:** Allows you to send locations from your smartphone to your navigation device.

## Pairing with Your Smartphone

You can pair your dēzlCam device with your smartphone and the dēzl app to enable additional features and access live information ([Live Services, Traffic, and Smartphone Features](#), page 36).

- 1 From the app store on your smartphone, install the dēzl app.
- 2 Turn on your dēzlCam device, and place the device and your smartphone within 3 m (10 ft.) of each other.
- 3 On your phone, open the dēzl app.
- 4 Follow the on-screen instructions to sign in to a Garmin account and complete the pairing and setup process.

The main app dashboard appears. After the devices are paired, they connect automatically when they are turned on and within range.

## Disabling Bluetooth Features (Android™)

By default, all compatible Bluetooth features are enabled when you pair your phone. You can disable specific Bluetooth features and remain connected to the other features.

- 1 Select  > **Wireless Networks**.
- 2 Select an option:
  - To disable all Bluetooth features, clear the Bluetooth check box.
  - To disable only hands-free calling, select the phone name and clear the **Phone calls** check box.

## Showing or Hiding App Notifications (Android)

You can use the dēzl app to customize which types of smartphone notifications appear on your dēzlCam device.

- 1 On your phone, open the dēzl app.
- 2 Select  > **Smart Notifications**.  
A list of your smartphone apps appears.
- 3 Select the toggle switch next to an app to enable or disable notifications for the app.

## Disabling Bluetooth Features (iPhone)

By default, all compatible Bluetooth features are enabled when you pair your phone. You can disable specific Bluetooth features and remain connected to the other features.



1 Select  > **Wireless Networks**.

2 Select an option:

- To disable hands-free calling, select the phone name, and clear the **Phone calls** check box.

**TIP:**  appears colored next to the phone name used for hands-free calling.

- To disable dēzl app data and smartphone notifications, select **iOS Services**, and clear the **iOS Services** check box.



**TIP:**  and  appear colored when the services are active.

## Showing or Hiding Notification Categories (iPhone)

You can filter the notifications shown on your device by showing or hiding categories.

1 Select  > **Wireless Networks**.

2 Select **iOS Services**.

**TIP:**  and  appear colored when the services are active.

3 Select **Smart Notifications**.

4 Select the check box next to each notification to show.

## Viewing Videos and Photos on Your Smartphone

Before you can view videos and photos on your smartphone, you must pair your dēzlCam device with the dēzl app ([Pairing with Your Smartphone, page 36](#)).

**NOTE:** The device stops recording and alerts are disabled while viewing videos or photos.

1 From the dēzl app on your smartphone, select **Videos and Photos**.

2 Select an option:

- To view a photo or video you saved, select a file from the **Saved** category.
- To view recent video footage that has not been saved, select a video from the **Temporary** category.

## Deleting a Video or Photo Using Your Smartphone

1 When you are viewing the list of saved videos or photos on your smartphone, select **Select**.

2 Select one or more files.

3 Select .

## Bluetooth Feature Status Icons

Status icons appear in the Bluetooth settings next to each paired device.

Select  > **Wireless Networks**.

- A gray icon indicates the feature is disabled or disconnected for that device.
- A colored icon indicates the feature is connected and active for that device.

	Hands-free calling
	dēzl features and services

## Smart Notifications

While your device is connected to the dēzl app, you can view notifications from your smartphone on your dēzlCam device, such as text messages, incoming calls, and calendar appointments.

**NOTE:** You may need to wait a few minutes to receive notifications on your navigation device after it connects to the dēzl app.  appears colored in the Bluetooth settings when smart notifications are connected and active ([Bluetooth Feature Status Icons, page 37](#)).

## Receiving Notifications

### WARNING

Do not read or interact with notifications while driving, because doing so can cause distraction that could lead to an accident resulting in serious personal injury or death.

Before you can use this feature, your device must be connected to a supported phone running the dēzl app ([Live Services, Traffic, and Smartphone Features, page 36](#)).

From most pages, a popup appears when the device receives a notification from your smartphone. If the device is moving, you must verify you are a passenger and not the driver before you can view notifications.

**NOTE:** If you are viewing the map, notifications appear in a map tool.

- To ignore a notification, select **OK**.  
The popup closes, but the notification remains active on your phone.
- To view a notification, select **View**.
- To listen to the notification, select **View > Play**.  
The device reads the notification using text-to-speech technology. This feature is not available for all languages.
- To perform additional actions, such as dismissing the notification from your phone, select **View**, and select an option.

**NOTE:** Additional actions are available for only some notification types and must be supported by the app generating the notification.

## Receiving Notifications while Viewing the Map

### WARNING

Do not read or interact with notifications while driving, because doing so can cause distraction that could lead to an accident resulting in serious personal injury or death.

Before you can use this feature, your device must be connected to a supported phone running the dēzl app ([Live Services, Traffic, and Smartphone Features, page 36](#)).

When you are viewing the map, new notifications appear in a map tool at the edge of the screen. If the device is moving, you must verify you are a passenger and not the driver before you can view notifications.

- To ignore a notification, select **X**, or wait for popup to expire.  
The popup closes, but the notification remains active on your phone.
- To view a notification, select the notification text.
- To listen to the notification, select **Play Message**.  
The device reads the notification using text-to-speech technology. This feature is not available for all languages.

## Viewing the List of Notifications

You can view a list of all active notifications.

- 1 Select  > **Smart Notifications**.

The list of notifications appears. Unread notifications appear black, and previously read notifications appear gray.

- 2 Select an option:

- To view a notification, select the notification description.
- To listen to a notification, select .

The device reads the notification using text-to-speech technology. This feature is not available for all languages.

## Going to an Address or Location Using the dēzl App

You can use the dēzl app to search for an address, business, or point of interest, and send it to your dēzlCam device for navigation.

- 1 From the dēzl app, select **Where To?**.

- 2 Select an option:

- To search for an address near you, enter the house number and street name.
- To search for an address in another city, enter the house number, street name, city, and state.
- To search for a business name, enter all or part of the name.
- To search for a city, enter the city and state.

As you type, suggestions appear below the search field.

- 3 Select a suggested search result.

The app displays the location on a map.

- 4 Select **Go!** to start a route.

The dēzlCam device starts navigating to the selected location, and the location is added to your recent searches in the Where To? menu.

## Hands-Free Calling

**NOTE:** While most phones are supported and can be used, it cannot be guaranteed that a particular phone can be used. All features may not be available for your phone.

Using Bluetooth wireless technology, your device can connect to your mobile phone to become a hands-free device (*Live Services, Traffic, and Smartphone Features, page 36*). While connected, you can place or receive calls using your device.

## Placing a Call

### Dialing a Number



- 1 Select  > **Phone** > **Dial**.
- 2 Enter the number.
- 3 Select **Dial**.

### Calling a Contact in Your Phone Book

Your phone book is loaded from your phone to the device each time your phone and the device connect. It may take a few minutes for the phone book to be available. Some phones do not support this feature.

- 1 Select  > **Phone** > **Phone Book**.
- 2 Select a contact.
- 3 Select **Call**.

## Calling a Location

- 1 Select  > **Phone** > **Browse Categories**.
- 2 Select a point of interest.
- 3 Select  > **Call**.

## Placing a Call Using Voice Dial

- 1 Select  > **Phone** > **Voice Dial**.
- 2 Listen for the voice prompt.
- 3 Say **Call**, and say the contact name, phone number, or location you want to call.

## Receiving a Call

When you receive a call, select **Answer** or **Ignore**.



## Using the Call History

Your call history is loaded from your phone to the device each time your phone and the device connect. It may take a few minutes for the call history to be available. Some phones do not support this feature.

- 1 Select  > **Phone** > **Call History**.
- 2 Select a category.  
A list of calls appears, with the most recent calls at the top.
- 3 Select a call.

## Using In-Call Options

In-call options appear on the map when you answer a call. Some options may not be compatible with your phone.

**TIP:** If you close the in-call options page, you can open it again by selecting  from the main menu. You can also select  > **Phone** from the map.



- To set up a conference call, select the caller ID, and select **Add Call**.
- To transfer audio to your phone, select **Handset**.

**TIP:** You can use this feature if you want to disconnect the Bluetooth connection and remain on the call, or if you need privacy.

- To use the dial pad, select the caller ID, and select **Keypad**.  
**TIP:** You can use this feature to use automated systems, such as voice mail.
- To mute the microphone, select **Mute**.
- To hang up, select **End**.

## Saving a Home Phone Number

**TIP:** After you save a home number, you can edit the home number by editing “Home” in your list of saved locations ([Editing a Saved Location, page 23](#)).

- 1 Select  > **Phone** >  > **Set Home Number**.
- 2 Enter your phone number.
- 3 Select **Done**.

## Calling Home

Before you can call home, you must enter a phone number for your home location.

Select  > **Phone** > **Call Home**.

## Deleting a Paired Phone

You can delete a paired phone to prevent it from automatically connecting to your device in the future.

- 1 Select  > **Wireless Networks**.
- 2 Select the phone, and select **Forget Device**.

## Traffic

### NOTICE

Garmin is not responsible for the accuracy or timeliness of the traffic information.

Your device can provide information about traffic on the road ahead or on your route. You can set your device to avoid traffic when calculating routes, and to find a new route to your destination if a large traffic delay occurs on your active route ([Traffic Settings, page 60](#)). The traffic map allows you to browse the map for traffic delays in your area.

To provide traffic information, your device must be receiving traffic data.

- All product models can receive subscription-free traffic data using the dēzl app ([Receiving Traffic Data Using Your Smartphone, page 41](#)).

Traffic data is not available in all areas. For information about traffic coverage areas, go to [garmin.com/traffic](http://garmin.com/traffic).

## Receiving Traffic Data Using Your Smartphone

Your device can receive subscription-free traffic data while connected to a smartphone running the dēzl app.

- 1 Connect your device to the dēzl app ([Live Services, Traffic, and Smartphone Features, page 36](#)).
- 2 On your dēzlCam device, select  > **Traffic**, and verify the **Traffic** option is selected.

## Enabling Traffic

You can enable or disable traffic data.



- 1 Select  > **Traffic**.
- 2 Select the **Traffic** check box.

## Viewing Traffic on the Map

The traffic map shows color-coded traffic flow and delays on nearby roads.

- 1 From the main menu, select  > **Traffic**.
- 2 If necessary, select  > **Legend** to view the legend for the traffic map.

## Searching for Traffic Incidents

- 1 From the main menu, select  > **Traffic**.
- 2 Select  > **Incidents**.
- 3 Select an item in the list.
- 4 If there is more than one incident, use the arrows to view additional incidents.

# Vehicle and Driver Tools

## Break Planning

### NOTICE

This device by itself is NOT an approved substitute for logbook recording requirements under Federal Motor Carrier Safety Administration (FMCSA) regulations. Drivers should comply with all applicable federal and state hours-of-service requirements. When integrated with a Garmin eLog compliant Electronic Logging Device (ELD), the Garmin eLog device enables a motor carrier to comply with hours of service logging and break requirements. For more information, or to purchase a Garmin eLog device, go to [garmin.com/elog](http://garmin.com/elog).

When the break planning feature is enabled, the device notifies you one hour before suggested break times and drive hour limits and suggests break locations on your route. You can use this feature to keep track of your working hours, which may help you comply with safety regulations.

**NOTE:** Break planning features are not available when using the car vehicle profile.

### Taking a Suggested Break

When it is time for a break, the device notifies you and displays suggested break location POIs along your route.

Select a POI from the list of suggested break locations.

The device adds the break location as the next destination on your route.

### Starting the Break Timer

The break timer starts automatically when the vehicle is moving at least 8 kph (5 mph) for 30 seconds. You can start the timer manually at any time.

- 1 From the map, select  > **Break Planner**.
- 2 Select **Start Timer**.

### Pausing and Resetting the Break Timer

The break timer pauses automatically when the vehicle stops for three minutes or longer. You can pause the timer manually for brief stops, such as parking or stopping at a truck stop. At the end of your drive, you can manually reset the timer.

- 1 Select **Stop Timer**.
- 2 Select an option:
  - To pause the timer, select **Pause**.
  - To stop and reset the timer, select **Reset**.

### Adjusting Drive Hours

You can adjust your total hours driven to more closely match your hours of service records.

- 1 While using the break planner feature, select **Total Hours Driven**.
- 2 Enter the total hours driven.
- 3 Select **Save**.

### Adjusting the Daily Driving Limit

You can adjust the daily driving limit to correspond with legal requirements in your area.

**NOTE:** This feature is not available in all areas.

- 1 While using the break planner feature, select **Daily Hours Driven**.
- 2 Select the daily driving limit for your area.
- 3 Select **Save**.



## Garmin eLog

The Garmin eLog adapter enables a motor carrier to comply with hours of service logging and break requirements. When a Garmin eLog adapter is paired with your compatible mobile device, you can view hours of service information on your dēzlCam device. The Garmin eLog adapter is not available in all areas. For more information, or to purchase a Garmin eLog adapter, go to [garmin.com/elog](http://garmin.com/elog).

**NOTE:** Garmin eLog features are not available when using the car vehicle profile.

### Setting Up Garmin eLog Features On Your dēzl Device

- 1 Pair your Garmin eLog adapter with the Garmin eLog app on your mobile device (*Setting Up Your Garmin eLog Device, page 43*).
- 2 Pair your dēzl device with your compatible mobile device (*Live Services, Traffic, and Smartphone Features, page 36*).
- 3 Enable the Garmin eLog app to pair with a dēzl device (*Enabling the Garmin eLog App to Pair with a dēzl Device, page 43*).
- 4 If necessary, enable the Garmin eLog connection on your dēzl device (*Enabling or Disabling the Garmin eLog Connection on Your dēzl Device, page 43*).

### Setting Up Your Garmin eLog Device

You must set up and pair your Garmin eLog adapter with the Garmin eLog app in order to use the device.

- 1 From the app store on your mobile device, install and open the  Garmin eLog app.
- 2 On your mobile device, follow the on-screen instructions to set up and configure the Garmin eLog system.

**NOTE:** Until you complete the setup process, the device has limited functionality.

### Enabling the Garmin eLog App to Pair with a dēzl Device

- 1 From the Garmin eLog app, log in to a driver profile.
- 2 Select **Settings > Pair to Nearby Garmin dēzl**.

### Enabling or Disabling the Garmin eLog Connection on Your dēzl Device

- 1 From your dēzl device, select  > **Wireless Networks**.
- 2 Select the name of your paired mobile device.
- 3 Select or clear the **Garmin eLog Adapter** check box.

### Viewing Garmin eLog Information on Your dēzl Device

Before you can view Garmin eLog information on your dēzl device, you must complete the setup process (*Setting Up Your Garmin eLog Device, page 43*).

As you drive your vehicle, the device displays your duty status and total drive hours in the Garmin eLog map tool.

Select a field to view a summary of remaining drive hours.

### Viewing Garmin eLog Diagnostic and Malfunction Events

When the Garmin eLog device detects a diagnostic or malfunction event, it displays a notification on the device screen.

Select the diagnostic or malfunction notification to view details about the event.

**NOTE:** You can view additional information about diagnostic and malfunction events in the Garmin eLog app.

## IFTA

**NOTE:** This feature is not available in all areas.



Before you can use this feature, a truck vehicle profile must be active.

You can record data needed for International Fuel Tax Agreement documentation (IFTA), such as fuel-purchase data and miles driven.

## Entering Fuel Data



- 1 Select  > **IFTA** > **At the Pump**.
- 2 Enter the fuel price per gallon.
- 3 Select the **Fuel Used** field.
- 4 Enter the amount of fuel purchased.
- 5 If necessary, select the fuel type:
  - To record the amount in liters, select **Gallons** > **Liters** > **Save**.
  - To record the amount in gallons, select **Liters** > **Gallons** > **Save**.
- 6 If necessary, select the **Tax Included** check box.
- 7 Select **Next**.
- 8 Select an option to record the fuel station where you refueled:
  - Select a nearby fuel station from the list.
  - Select the text field, and enter the fuel station name and address.
- 9 Select the fuel purchaser.

## Editing Fuel Data

- 1 Select  > **IFTA** > **Fuel Journals**.
- 2 If necessary, select a vehicle profile.
- 3 If necessary, select a quarter.
- 4 Select a fuel record.
- 5 Select an option:
  - Select a field to edit the information.
  - Select  to delete the record.





## Viewing and Exporting a Jurisdiction Summary

The jurisdiction summary lists data for each state or province in which your vehicle has operated during each quarter. The jurisdiction summary is available in some areas.

- 1 Select  > **IFTA** > **Jurisdiction Summary**.
- 2 If necessary, select a truck.
- 3 If necessary, select a quarter.
- 4 Select  > **Export** > **OK** to export a jurisdiction summary.

The device exports the summary to a .csv file and stores it in the Reports folder on the device.

## Editing and Exporting Trip Reports

- 1 From the main menu, select  > **IFTA** > **Trip Reports**.
- 2 If necessary, select a truck.
- 3 If necessary, select a quarter.
- 4 Select a report.
- 5 Select an option:
  - Select  > **Delete**, and select the check box to delete a report.
  - Select  > **Combine**, and select the check boxes to combine reports.
  - Select  > **Export** > **OK**. The device exports the report to a .csv file and stores it in the **Reports** folder on the device.

## Viewing Exported Jurisdiction Summaries and Trip Reports

### NOTICE

If you do not know the purpose of a file, do not delete it. Your device memory contains important system files that should not be deleted.



- 1 Connect the device to your computer.
- 2 From the file browser on your computer, browse to the internal device storage, and open the **Reports** folder.
- 3 Open the **IFTA** folder.
- 4 Open the .csv file.

## Logging Service History

You can log the date and odometer reading when service or maintenance is performed on your vehicle. The device provides several service categories, and you can add custom categories ([Adding Service Categories, page 45](#)).



- 1 Select  > **Service History**.
- 2 Select a service category.
- 3 Select **Add Record**.
- 4 Enter the odometer reading, and select **Next**.
- 5 Enter a comment (optional).
- 6 Select **Done**.

## Adding Service Categories



- 1 Select  > **Service History**.
- 2 Select  > **Add Category**.
- 3 Enter a category name, and select **Done**.

## Deleting Service Categories



When you delete a service category, all service records in the category are also deleted.

- 1 Select  > **Service History**.
- 2 Select  > **Delete Categories**.
- 3 Select the service categories to delete.
- 4 Select **Delete**.

## Renaming Service Categories

- 1 Select  > **Service History**.
- 2 Select the category to be renamed.
- 3 Select  > **Rename Category**.
- 4 Enter a name, and select **Done**.

## Deleting Service Records

- 1 Select  > **Service History**.
- 2 Select a service category.
- 3 Select  > **Delete Records**.
- 4 Select the service records to be deleted.
- 5 Select **Delete**.

## Editing a Service Record

You can edit the comment, odometer reading, and date of a service record.

- 1 Select  > **Service History**.
- 2 Select a category.
- 3 Select a field.
- 4 Enter the new information, and select **Done**.

## PrePass<sup>®</sup>

### NOTICE

Garmin is not responsible for the accuracy or timeliness of the information provided by the PrePass app.

**NOTE:** Before you can use this feature, you must have an active PrePass account.

The PrePass app enables drivers to verify the safety, credentials, and weight of a commercial vehicle with upcoming weigh stations. You can pair your dēzlCam device with the dēzl app and the PrePass app to receive upcoming weigh station notifications on your dēzlCam device.

**NOTE:** This feature is available only in the United States.

## Loyalty Programs



From your dēzlCam device, you can access loyalty programs from some of the travel plazas in the United States, including Love's Travel Stops and Pilot Flying J Travel Centers. You can use the loyalty program apps on your dēzlCam device to check reward points balances and other loyalty program information. To activate loyalty program features, sign in to your loyalty program account in the dēzl app.

**NOTE:** This feature is available only in the United States.

# Using the Apps

## Viewing the Owner's Manual on Your Device

You can view the complete owner's manual on the device screen in many languages.

- 1 Select  > **Owner's Manual**.  
The owner's manual appears in the same language as the software text (*Language and Keyboard Settings*, page 61).
- 2 Select  to search the owner's manual (optional).

## Viewing the Weather Forecast

### NOTICE

Garmin is not responsible for the accuracy or timeliness of the weather data.

Before you can use this feature, your device must be receiving weather data. You can connect your device to the dēzl app to receive weather data (*Live Services, Traffic, and Smartphone Features*, page 36).



- 1 Select  > **Weather**.  
The device shows the current weather conditions and a forecast for the next several days.
- 2 Select a day.  
The detailed forecast for that day appears.

## Viewing Weather Near a Different City

- 1 Select  > **Weather** > **Current Location**.
- 2 Select an option:
  - To view weather for a favorite city, select a city in the list.
  - To add a favorite city, select **Add City**, and enter a city name.

## Viewing the Weather Radar

Before you can use this feature, your device must be connected to a supported phone running the dēzl app ([Live Services, Traffic, and Smartphone Features, page 36](#)).



- 1 Select  > **Weather Radar**.
- 2 Select  to animate the radar map.

## Viewing Weather Alerts

Before you can use this feature, your device must be connected to a supported phone running the dēzl app ([Live Services, Traffic, and Smartphone Features, page 36](#)).

**NOTE:** This feature is not available in all areas.



While you are traveling with your device, weather alerts may appear on the map. You can also view a map of weather alerts near your current location or near a selected city.

- 1 Select  > **Weather**.
- 2 If necessary, select a city.
- 3 Select  > **Weather Alerts**.

## Checking Road Conditions

Before you can use this feature, your device must be connected to a supported phone running the dēzl app ([Live Services, Traffic, and Smartphone Features, page 36](#)).

You can view weather-related road conditions for the roads in your area, on your route, or in another city.

- 1 Select  > **Weather**.
- 2 If necessary, select a city.
- 3 Select  > **Road Conditions**.



## Route Planner

You can use the route planner to create and save a route, which you can navigate later. This can be useful for planning a delivery route, a vacation, or a road trip. You can edit a saved route to further customize it, including reordering locations, adding suggested attractions, and adding shaping points.





You can also use the route planner to edit and save your active route.

## Planning a Route

A route can include many locations, and it must include at least a starting location and one destination. The starting location is the location from which you plan to start your route. If you start navigating the route from a different location, the device gives you the option to route to your starting location first. For a round trip, the starting location and final destination can be the same.



- 1 Select  > **Route Planner** > **Create Route**.
- 2 Select **Select Start Location**.
- 3 Choose a location for your starting point, and select **Select**.
- 4 Select **Select Destination**.
- 5 Choose a location for a destination, and select **Select**.
- 6 Select **Add Location** to add more locations (optional).
- 7 After you have added all the necessary locations, select **Next** > .
- 8 Enter a name, and select **Done**.

## Editing and Reordering Locations in a Route

- 1 Select **Route Planner**.
- 2 Select a saved route.
- 3 Select **List**.
- 4 Select a location.
- 5 Select an option:
  - To change the location, select , and enter a new location.
  - To move the location up or down, select , and drag the location to a new position in the route.
  - To add a new location after the selected location, select .
  - To remove the location, select .

## Changing Routing Options for a Route

You can customize how the device calculates your route.

- 1 Select  > **Route Planner**.
- 2 Select a saved route.
- 3 Select .
- 4 Select an option:
  - To add shaping points to your route, select **Shaping**, and select at least one location.
  - To change the calculation mode for the route, touch a route segment, and select a calculation mode.

## Navigating to a Saved Route

- 1 Select  > **Route Planner**.
- 2 Select a saved route.
- 3 Select **Go!**.
- 4 Select the first location to navigate to, and select **OK**.
- 5 Select **Start**.

The device calculates a route from your current location to the selected location, and then it guides you to the remaining route destinations in order.

## Editing and Saving Your Active Route

If a route is active, you can use the route planner to edit and save it.

- 1 Select  > **Route Planner** > **My Active Route**.
- 2 Edit your route using any of the route planner features.

The route recalculates each time you make a change.
- 3 Select **Save** to save your route, which you can navigate again later (optional).

## photoLive Traffic Cameras

Before you can use this feature, your device must be connected to the dēzl app ([Live Services, Traffic, and Smartphone Features, page 36](#)).

photoLive traffic cameras provide live images of traffic conditions on major roadways and intersections. The photoLive service is not available in all areas.

## Viewing and Saving photoLive Traffic Cameras

You can view live images from nearby traffic cameras. You can also save traffic cameras for areas you travel frequently.

1 Select  > **photoLive**.

2 Select **Touch to Add**

3 Select a road.

4 Select a traffic camera location.

A preview of the live image from the camera appears next to a map of the camera's location. You can select the image preview to view the full-sized image.

5 Select **Save** to save the camera (optional).

A thumbnail image preview of the camera is added to the main screen of the photoLive app.

## Viewing photoLive Traffic Cameras on the Map

The photoLive map tool shows traffic cameras from the road ahead of you.

1 From the map, select  > **photoLive**.

The device shows the live image from the nearest traffic camera on the road ahead, along with the distance to the camera. When you pass the camera, the device loads the live image of the next camera on the road.

2 If no cameras are found for the road, select **Find Cameras** to view or save nearby traffic cameras (optional).

## Saving a Traffic Camera

1 Select  > **photoLive**.

2 Select **Touch to Add**.

3 Select a traffic camera.

4 Select **Save**.

## Wireless Cameras

Your device can display the video feed from one or more connected wireless cameras (sold separately).

## Pairing the BC 40 Camera with a Garmin Navigation Device

You can pair the camera with a compatible Garmin navigation device. For more information about compatible Garmin devices, go to the product page at [garmin.com/bc40](http://garmin.com/bc40).

1 Update your navigation device to the latest software.

2 Install batteries in the camera.

The camera enters pairing mode automatically, and the LED flashes blue while the camera is in pairing mode. The camera remains in pairing mode for two minutes. If pairing mode expires, you can remove and reinstall the batteries.

3 Bring the compatible Garmin navigation device outside your vehicle and within 1.5 m (5 ft.) of the camera, and turn on the navigation device.

The device detects your camera automatically and prompts you to pair with it.

4 Select **Yes**.

**TIP:** If the navigation device does not detect the camera automatically, you can select  > **Wireless Camera** > **Add New Camera** to pair with it manually. The location of the pairing menu may vary by device model. See the owner's manual for your navigation device for additional pairing instructions.

The device pairs with your camera.

5 Enter a name for the camera (optional).

You should use a descriptive name that clearly identifies the location of the camera.

6 Select **Done**.

## Pairing a BC 50 Camera with a Garmin Navigation Device

You can pair the BC 50 camera with a compatible Garmin navigation device. Go to [garmin.com/bc50](http://garmin.com/bc50) for more information about device compatibility.

1 Update your navigation device to the latest software.

Your device may not support the BC 50 camera without the latest software. For more information about updating the device software, see the owner's manual for your navigation device.

2 Select  > **Wireless Camera** > **Add New Camera**.

3 Follow the on-screen instructions to finish pairing and setting up the camera.

After you complete the pairing process with a camera for the first time, it connects automatically to the Garmin navigation device when power is applied.

## Viewing the Backup Camera

### **WARNING**

This device is intended to enhance your situational awareness when used properly. If used improperly, you could become distracted by the display, which could lead to an accident causing serious personal injury or death. Only access the information displayed on the device with a glance. Always maintain awareness of your surroundings and do not stare at the display or become distracted by the display. Focusing on the display could prevent you from avoiding obstacles or hazards.

- If your camera is connected to a reverse lamp (recommended), place the vehicle into reverse.
- If your camera is connected to constant power, select .
- To show or hide the camera view using voice commands, say **OK Garmin, Show Video** or **Hide Video**.

**NOTE:** Voice commands are not available on all navigation devices. The voice commands may vary based on your navigation device model. This feature is not available for all languages or may require additional navigation device setup for some languages.



## Aligning the Guidance Lines

For the best reference, the guidance lines should be aligned to reflect the outside edges of the vehicle. You should align the guidance lines separately for each backup camera. When you change the camera angle, you should immediately align the guidance lines again.

- 1 Position your vehicle with the driver's side closely aligned to a curb, driveway, or parking stall lines.  
**TIP:** It can be helpful to position the vehicle in the center of a parking stall, and then pull forward into the next stall. This allows you to use the parking stall lines at the rear of the vehicle as reference points for alignment.
- 2 From the paired Garmin navigation device, select **⚙️ > Wireless Cameras**.
- 3 Select the paired camera name, and select **Guidance Lines > Adjust Guidance Lines**.
- 4 Use the arrows in the corners of the screen to move the ends of the white, driver's-side guidance line. The guidance line should appear directly on top of the curb, driveway, or parking stall line.

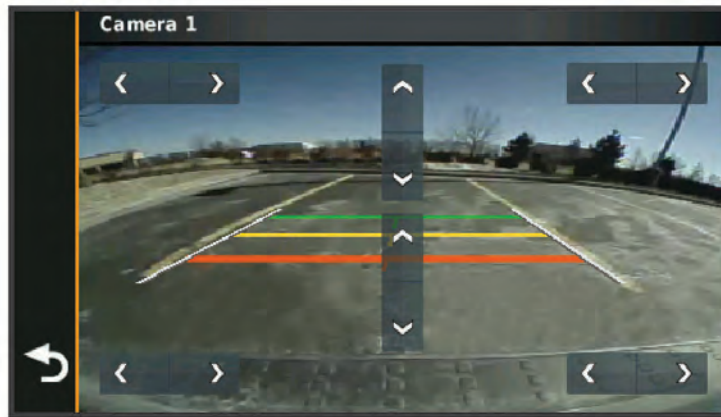

- 5 Use the arrows in the center of the screen to move the colored distance guidance lines up or down. The red guidance line should be aligned with the rearmost part of your vehicle. This could be the rear bumper, a trailer hitch, or another object protruding from the rear of the vehicle.
- 6 Reposition the vehicle with the passenger side closely aligned to a curb, driveway, or parking stall lines, and use the arrows to align the white, passenger-side guidance line. The guidance lines should be symmetrical.

## Viewing Previous Routes and Destinations

Before you can use this feature, you must enable the travel history feature ([Device and Privacy Settings, page 61](#)).

You can view your previous routes and places you have stopped on the map.

Select **☰ > Trip History**.

## Music Player

The music player allows your device to control the music currently playing from a media app on your paired phone. You can open the media player at any time by selecting Music from the main menu.

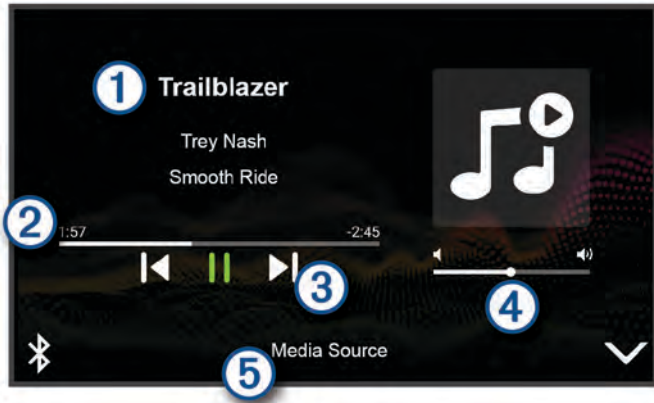

- |   |   |
|---|---|
| ① | Information about the currently playing media, such as title, artist, album, station, or channel. |
| ② | Progress through the current media item.  |
| ③ | Playback controls. The controls change based on the source providing the media.                   |
| ④ | Volume controls. You can use the slider to adjust the volume.                                     |
| ⑤ | The name of the connected media source.   |

### Adding the Music Player Tool to the Map



The music player map tool enables you to control the music player from your map.

- 1 Open the map.
- 2 Select  > **Music**.

The music player controls appear on the map.

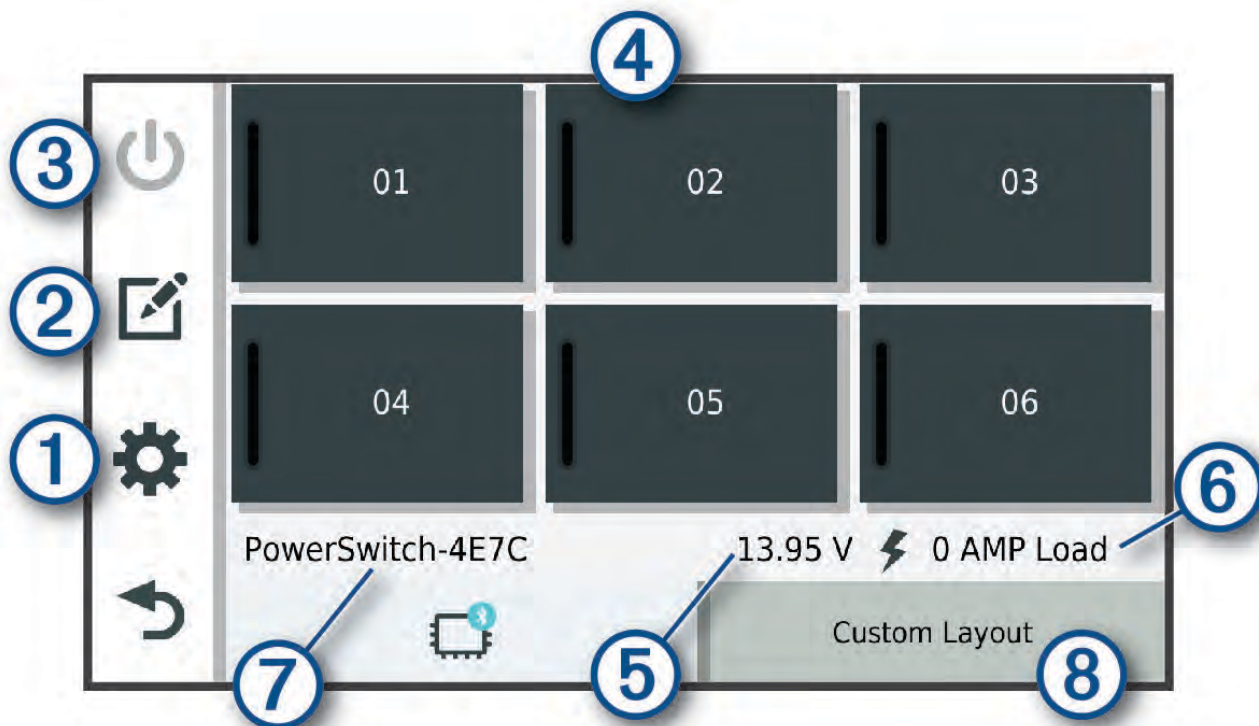
## Garmin PowerSwitch™ App



① 	Opens the app settings menu
② 	Enters editing mode to customize the app layout and functions
③ 	Turns off all outputs
④ Power buttons	Activates each connected output
⑤	Displays input voltage
⑥	Displays the total amperage of the selected Garmin PowerSwitch device
⑦	Displays the device name
⑧	Displays Garmin PowerSwitch device tabs and custom layout tabs

### Activating a Power Switch



Before you can use the Garmin PowerSwitch app to activate a switch, you must install your Garmin PowerSwitch device in your vehicle and pair it with the Garmin PowerSwitch app.

From the Garmin PowerSwitch app, select a power button to turn a switch on or off.

### Turning Off All Switches

Select .

## Customizing a Button

- 1 From the Garmin PowerSwitch app screen, select .  
The app enters editing mode.
- 2 Select  on the button you want to customize.
- 3 Select an option:
  - To change the name of the button, select the **Button Label** field, and enter a name.
  - To add an icon to the button, select the **Icon** field, and select an icon.
  - To change the button color, select a color.
  - To change the button mode, select a button mode.
  - To adjust the intensity of the switch, use the slider.
  - To set the button to activate with a control input, select a control input.
- 4 Select .
- 5 Select **Done**.

## Assigning a Switch to a Control Input



Before you can use control input functions, you must connect a control input to your Garmin PowerSwitch device.

You can assign one or more switches to turn on when the Garmin PowerSwitch device receives a signal from a control input.



- 1 Select .
- 2 Select your Garmin PowerSwitch device.
- 3 Select a control input.
- 4 Select one or more switches.

## Adding a Custom Layout



You can add a custom layout tab to the Garmin PowerSwitch app. Buttons added to a custom layout can control multiple switches at the same time.

- 1 From the Garmin PowerSwitch app, select .  
The device enters editing mode.
- 2 Select .



## Adding a Button to a Custom Layout

- 1 From the Garmin PowerSwitch app, select a custom layout tab.
- 2 Select .  
The app enters editing mode.
- 3 Select **Add Button**.
- 4 On the new button, select .
- 5 Select an option:
  - To change the name of the button, select the **Button Label** field, and enter a name.
  - To add an icon to the button, select the **Icon** field, and select an icon.
  - To change the button color, select a color.
- 6 Select **Add Action**.
- 7 If necessary, select a Garmin PowerSwitch device and a switch.
- 8 Select an action:
  - To set the button to turn the switch on or off with each press, select **Toggle**.
  - To set the button to turn on the switch, select **Turn On**.
  - To set the button to turn off the switch, select **Turn Off**.
- 9 Select a button mode:
  - To set the button to activate with one touch, select **Normal**.
  - To set the button to activate only while touching the button, select **Momentary**.
  - To set the button to turn on and off repeatedly, select **Strobe**, and select time intervals.
- 10 If applicable, use the slider to set the brightness of lights.
- 11 Select .
- 12 If necessary, select **Add Action** to add additional actions for the button.  
You can add one action for every switch on the Garmin PowerSwitch device.

## Arranging Buttons In a Custom Layout

- 1 From the Garmin PowerSwitch app, select a custom layout tab.
- 2 Select .  
The app enters editing mode.
- 3 On the button you want to move, hold  and drag the button to a new location.

## Deleting a Custom Layout or Button

- 1 From the Garmin PowerSwitch app, select a custom layout tab.
- 2 Select .  
The app enters editing mode.
- 3 Select an option:
  - To delete a button, select  on the button you want to delete.
  - To delete a layout tab, select  on the layout tab.



## Routines

Routines automate your Garmin PowerSwitch device. When you define a routine on your compatible Garmin navigation device, it turns switches on or off automatically when the conditions of the routine are met. For example, you can set a routine to turn on a switch at specific time each day or when your vehicle reaches a specific speed. Routines are available only when using a compatible Garmin navigation device.



## Adding a Routine

- 1 From the Garmin PowerSwitch app, select  > **Routines**.
- 2 If necessary, select **Add Routine**.
- 3 Select **When**.
- 4 Select a trigger:
  - To set a switch to trigger when your vehicle reaches a specific speed, select **Speed** > **Next**, and follow the on-screen instructions to enter speed thresholds.
  - To set a switch to trigger at a specific time each day, select **Time** > **Next**, and enter a time.
  - To set a switch to trigger at sunrise, select **Sunrise**.
  - To set a switch to trigger at sunset, select **Sunset**.
- 5 Select **Add Action**.
- 6 Select a device, a switch, an action, and a button mode.
- 7 If necessary, use the slider to adjust the dimmer.
- 8 Select **Save**.

## Editing a Routine

- 1 From the Garmin PowerSwitch app, select  > **Routines**.
- 2 Select  on the routine you want to edit.
- 3 Select an option:
  - To change the trigger for the routine, select **When**, and select a trigger.
  - To change an action, select  on the action you want to change, and update the action.
  - To add an action to the routine, select **Add Action**, and enter information about the action.
- 4 Select **Save**.

## Deleting a Routine

- 1 From the Garmin PowerSwitch app, select  > **Routines**.
- 2 Select  on the routine you want to delete.

# Voice Command

**NOTE:** Voice command is not available for all languages and regions, and may not be available on all models.

**NOTE:** Voice Activated Navigation may not achieve desired performance when in a noisy environment.

Voice command allows you to use your device by saying words and commands. The voice command menu provides voice prompts and a list of available commands.

## Tips for Speaking to the Device

- Speak in a clear voice directed at the device.
- Start each request with *OK, Garmin*.
- Reduce background noise, such as voices or the radio, to help the device interpret your commands more accurately.
- Respond to voice prompts from the device as needed.
- If you do not receive a useful response, try rephrasing your request.
- If the device does not respond to your requests, verify it is not placed near a speaker or air vent, which can produce noise that interferes with the microphone.

## Launching Garmin Voice-Activated Navigation

Garmin voice-activated navigation allows you to use plain language spoken requests to search for locations and addresses, start routes with turn-by-turn directions, place hands-free phone calls, and more.

- Say *OK, Garmin*, and make a spoken request.  
For example, you can say phrases like these:
  - *OK, Garmin, take me home.*
  - *OK, Garmin, where's the library?*

## Controlling the Camera Using Voice Commands

- 1 Say **OK Garmin** to activate the voice control feature.  
The camera plays a tone and starts listening for a command.
- 2 Say a command:
  - To save a video, say **Save Video**.
  - To take a picture, say **Take a Picture**.The camera plays a tone when it recognizes your command.

## Checking Your Arrival Time

While a route is active, you can say a phrase to check your estimated time of arrival at your destination.  
Say *OK, Garmin, what time will we arrive?*.

## Placing a Phone Call Using Your Voice

You can use a voice command to call to a contact from the phone book of your paired smartphone.  
Say *OK, Garmin, call*, and say the contact name.  
For example, you can say *OK, Garmin, call Mom..*

## Changing Device Settings Using Your Voice

- You can say phrases like these to set device settings to a value from 0 to 10.
- *OK, Garmin, increase the volume.*
  - *OK, Garmin, set the volume to 0.*
  - *OK, Garmin, set the volume to 9.*
  - *OK, Garmin, decrease the brightness.*
  - *OK, Garmin, set the brightness to 5.*

# Settings

## Map and Vehicle Settings

Select  > **Map Display**.

**Map Vehicle Icon:** Sets the vehicle icon that represents your position on the map.

**Driving Map View:** Sets the perspective on the map.

**Map Detail:** Sets the level of detail on the map. More detail may cause the map to draw slower.

**Map Theme:** Changes the color of the map data.

**Map Layers:** Sets the data that appears on the map page ([Customizing the Map Layers, page 35](#)).

**Auto Zoom:** Automatically selects the zoom level for optimal use of your map. When disabled, you must zoom in or out manually.

**Skip Next Stop Confirmation:** Sets a confirmation message to appear when skipping a location on your route.

**myMaps:** Sets which installed maps the device uses.

## Enabling Maps

You can enable map products installed on your device.

**TIP:** To purchase additional map products, go to <http://buy.garmin.com>.

- 1 Select  > **Map Display** > **myMaps**.
- 2 Select a map.

## Navigation Settings

Select  > **Navigation**.

**Calculation Mode:** Sets the route calculation method.

**Avoidances:** Sets road features to avoid on a route.

**Custom Avoidances:** Allows you to avoid specific roads or areas.

**Environmental Zones:** Sets the avoidance preferences for areas with environmental or emissions restrictions that may apply to your vehicle.

**Restricted Mode:** Disables all functions that require significant operator attention.

**GPS Simulator:** Stops the device from receiving a GPS signal, and saves battery power.

## Calculation Mode Settings

Select  > **Navigation** > **Calculation Mode**.

The route calculation is based on road speeds and vehicle acceleration data for a given route.

**Faster Time:** Calculates routes that are faster to drive but can be longer in distance.

**Straight Line:** Calculates a direct line from your location to your destination.

## Setting a Simulated Location

If you are indoors or not receiving satellite signals, you can use the GPS simulator to plan routes from a simulated location.

- 1 Select  > **Navigation** > **GPS Simulator**.
- 2 From the main menu, select **View Map**.
- 3 Tap the map twice to select an area.  
The address of the location appears at the bottom of the screen.
- 4 Select the location description.
- 5 Select **Set Location**.



## Wireless Network Settings

The wireless network settings allow you to manage Wi-Fi networks, paired Bluetooth devices, and Bluetooth features.

Select  > **Wireless Networks**.

**Bluetooth:** Enables Bluetooth wireless technology.

**Paired Device Name:** The names of paired Bluetooth devices appear in the menu. You can select a device name to change Bluetooth feature settings for that device.

**Search for Devices:** Searches for nearby Bluetooth devices.

**Friendly Name:** Allows you to enter a friendly name that identifies your device on other devices with Bluetooth wireless technology.

**Wi-Fi:** Enables the Wi-Fi technology.

**Saved Networks:** Allows you to edit or remove saved networks.

**Search for Networks:** Searches for nearby Wi-Fi networks ([Connecting to a Wi-Fi Network, page 62](#)).

## Driver Assistance Settings

Select  > **Driver Assistance**.

**Driver Alerts:** Allows you to enable or disable alerts for upcoming zones or road conditions ([Driver Awareness Features and Alerts, page 13](#)).

**Speeding Alert:** Alerts you when you are exceeding the speed limit.

**Reduced Speed Tone:** Alerts you when the speed limit decreases.

**Route Preview:** Displays a preview of the major roads in your route when you start navigation.

**Break Planning:** Reminds you to take a break, and displays upcoming services after you drive for an extended time. You can enable or disable break reminders and upcoming service suggestions.

**Proximity Alerts:** Alerts you when you approach speed cameras or red light cameras.

**Plan Arrival:** Displays a map of your destination at the end of a route. You can also enable your device to download satellite imagery using the mobile data on your paired smartphone.

**Forward Collision Warning:** Allows you to enable and set the sensitivity of the forward collision warning. A higher sensitivity alerts you sooner than a lower sensitivity.

**Lane Departure Warning:** Enables the device to alert you when it detects you may be crossing a lane boundary unintentionally.

## Proximity Alerts Settings

**NOTE:** You must have custom points of interest (POIs) loaded for proximity points alerts to display.

**NOTE:** This feature is not available in all areas.

Select  > **Driver Assistance** > **Proximity Alerts**.

**Audio:** Sets the style of alert that plays when you approach proximity points.

**Alerts:** Sets the type of proximity points for which alerts are played.

## Dash Cam Settings

Select  > **Dash Cam**.

**Camera Placement:** Allows you to set the vehicle height and camera position, and align the dash cam.

**Record on Startup:** Enables the dash camera to start recording video automatically when you turn on the device.

**Video Resolution:** Sets the resolution and quality for dash cam recordings.

**Incident Detection:** Sets the sensitivity for incident detection features. The device saves video automatically when it detects a possible driving incident.

**Record Audio:** Enables or disables audio recording while you are recording with the dash cam.

**Data Overlay:** Includes date, time, location, and speed information in the recorded video.

**Unsaved Videos:** Determines when the device deletes unsaved video footage. When the **Delete When Full** option is selected, the device deletes the oldest unsaved video when the memory card storage is full. When the **Promptly Delete** option is selected, the device continually deletes unsaved video more than three minutes old and deletes all unsaved video each time it is powered off. This is useful to help protect data privacy. While the Promptly Delete option is selected, you cannot view unsaved video in the gallery.

## Backup Camera Settings

The backup camera settings allow you to manage paired Garmin backup cameras and camera settings. This menu appears on your navigation device only when the device is connected to a wireless camera receiver cable. See the owner's manual for your backup camera for detailed information about pairing cameras and camera settings. Go to [garmin.com/backupcamera](http://garmin.com/backupcamera) to purchase a Garmin backup camera.

Select  > **Wireless Camera**, and select a paired camera.

**Unpair:** Removes the paired camera. You must pair the camera again before you can view it using this device and cable.

**Rename:** Allows you to rename the paired camera.

**Guidance Lines:** Shows or hides guidance lines and allows you to adjust the position of the guidance lines.

## Display Settings

Select  > **Display**.

**Color Mode:** Allows you to select day or night color mode. If you select the Auto option, the device automatically switches to day or night colors based on the time of day.

**Brightness:** Allows you to adjust the display brightness.

**Display Timeout:** Allows you to set the amount of idle time before your device enters sleep mode while using battery power.

**Screenshot:** Allows you to take a picture of the device screen. Screenshots are saved in the Screenshot folder of the device storage.

## Traffic Settings

From the main menu, select  > **Traffic**.

**Traffic:** Enables the traffic feature.

## Units and Time Settings

To open the Units and Time settings page, from the main menu, select  > **Units & Time**.

**Current Time:** Sets the device time.

**Time Format:** Allows you to select a 12-hour, 24-hour, or UTC display time.

**Units:** Sets the unit of measure used for distances.

**Position Format:** Sets the coordinate format and datum used for geographical coordinates.

## Setting the Time

- 1 From the main menu, select the time.
- 2 Select an option:
  - To set the time automatically using GPS information, select **Automatic**.
  - To set the time manually, drag the numbers up or down.

## Language and Keyboard Settings

To open the Language and Keyboard settings, from the main menu, select  > **Language & Keyboard**.

**Voice Language:** Sets the language for voice prompts.

**Text Language:** Sets all on-screen text to the selected language.

**NOTE:** Changing the text language does not change the language of user-entered data or map data, such as street names.

**Keyboard Language:** Enables keyboard languages.

## Device and Privacy Settings

Select  > **Device**.

**About:** Displays the software version number, the unit ID number, and information on several other software features.

**Regulatory:** Displays regulatory markings and information.

**EULAs:** Displays the end-user license agreements.

**NOTE:** You need this information when you update the system software or purchase additional map data.

**Software Licenses:** Displays software licensing information.

**Device Data Reporting:** Shares anonymous data to improve the device.

**Travel History:** Allows the device to store a record of the places you go. This allows you to view the trip log, use the Trip History feature, and use myTrends suggested routes.

**Reset:** Allows you to clear your travel history, reset settings, or delete all user data.

## Resetting Data and Settings

The device offers several options for deleting your user data and resetting all settings to the factory default values.

- 1 Select  > **Device** > **Reset**.
- 2 Select an option:
  - To clear your travel history, select **Clear Travel History**.  
This option deletes all records of the places you have traveled. It does not delete saved locations or installed maps.
  - To reset all settings to the factory default values, select **Reset Default Settings**.  
This option does not delete any user data.
  - To delete all user data and reset all settings to the factory default values, select **Delete Data and Reset Settings**.  
This option deletes all user data, including your saved locations, recently found locations, and travel history. Installed maps are not deleted.

# Device Information

## Viewing E-label Regulatory and Compliance Information

- 1 From the settings menu, swipe to the bottom of the menu.
- 2 Select **Device** > **Regulatory**.

## Specifications

Operating temperature range	From -20° to 55°C (from -4° to 131°F)
Charging temperature range	From 0° to 45°C (from 32° to 113°F)
Power input	Vehicle power using the included vehicle power cable. AC power using an optional accessory (for home and office use only).
Battery type	Rechargeable lithium-ion

## Charging the Device

**NOTE:** This Class III product shall be powered by an LPS power supply.

You can charge the battery in the device using any of these methods.

- Connect the device to vehicle power.
- Connect the device to an optional power adapter accessory, such as a wall power adapter.

You can purchase an approved Garmin AC-DC adapter suitable for home or office use from a Garmin dealer or [www.garmin.com](http://www.garmin.com). The device may charge slowly when connected to a third-party adapter.

## Device Maintenance

### Garmin Support Center

Go to [support.garmin.com](http://support.garmin.com) for help and information, such as product manuals, frequently asked questions, videos, and customer support.

### Map and Software Updates

For the best navigation experience, you should keep the maps and software on your device up to date.

Map updates provide the newest available changes to roads and locations in the maps used by your device. Keeping maps up to date helps your device find recently added locations and calculate more accurate routes. Map updates are large and may take several hours to complete.

Software updates provide changes and improvements to the device features and operation. Software updates are small and take a few minutes to complete.

You can update your device using two methods.

- You can connect the device to a Wi-Fi network to update directly on the device (recommended). This option allows you to update your device conveniently without connecting it to a computer.
- You can connect the device to a computer and update it using the Garmin Express application ([garmin.com/express](http://garmin.com/express)).

### Connecting to a Wi-Fi Network

The first time you turn on the device, it prompts you to connect to a Wi-Fi network and register your device. You can also connect to a Wi-Fi network using the settings menu.

- 1 Select  > **Wireless Networks**.
- 2 If necessary, select **Wi-Fi** to enable Wi-Fi technology.
- 3 Select **Search for Networks**.  
The device displays a list of nearby Wi-Fi networks.
- 4 Select a network.
- 5 If necessary, enter the password for the network, and select **Done**.

The device connects to the network, and the network is added to the list of saved networks. The device reconnects to this network automatically when it is within range.

## Updating Maps and Software Using a Wi-Fi Network

### NOTICE

Map and software updates may require the device to download large files. Regular data limits or charges from your internet service provider apply. Contact your internet service provider for more information about data limits or charges.

You can update the maps and software by connecting your device to a Wi-Fi network that provides access to the internet. This allows you to keep your device up to date without connecting it to a computer.

- 1 Connect the device to a Wi-Fi network ([Connecting to a Wi-Fi Network, page 62](#)).

While connected to a Wi-Fi network, the device checks for available updates. When an update is available,  appears on the  icon in the main menu.

- 2 Select  > **Updates**.

The device checks for available updates. When an update is available, **Update Available** appears below Map or Software.

- 3 Select an option:

- To install all available updates, select **Install All**.
- To install only map updates, select **Map > Install All**.
- To install only software updates, select **Software > Install All**.

- 4 Read the license agreements, and select **Accept All** to accept the agreements.

**NOTE:** If you do not agree with the license terms, you can select **Reject**. This stops the update process. You cannot install updates until you accept the license agreements.

- 5 Using the included USB cable, connect the device to external power, and select **Continue** ([Charging the Device, page 62](#)).

For the best results, a USB wall charger that provides at least 2 A power output is recommended. Many USB power adapters for smartphones, tablets, or portable media devices may be compatible.

- 6 Keep the device connected to external power and within range of the Wi-Fi network until the update process is complete.

**TIP:** If a map update is interrupted or canceled before it completes, your device may be missing map data. To repair missing map data, you must update the maps again using either Wi-Fi or Garmin Express.

## Updating Maps and Software with Garmin Express

You can use the Garmin Express application to download and install the latest map and software updates for your device.

1 If you do not have the Garmin Express application installed on your computer, go to [garmin.com/express](http://garmin.com/express) and follow the on-screen instructions to install it (*Installing Garmin Express, page 65*).

2 Open the  Garmin Express application.

3 Connect your device to your computer using a USB cable.

The small end of the cable connects to the USB port  on your dēzlCam device, and the large end connects to an available USB port on your computer.



4 From your dēzlCam device, select **Tap to Connect to Computer**.

5 When your dēzlCam device prompts you to enter file transfer mode, select **Continue**.

6 In the Garmin Express application, click **Add a Device**.

The Garmin Express application searches for your device and displays the device name and serial number.

7 Click **Add Device**, and follow the on-screen instructions to add your device to the Garmin Express application.

When setup is complete, the Garmin Express application displays the updates available for your device.

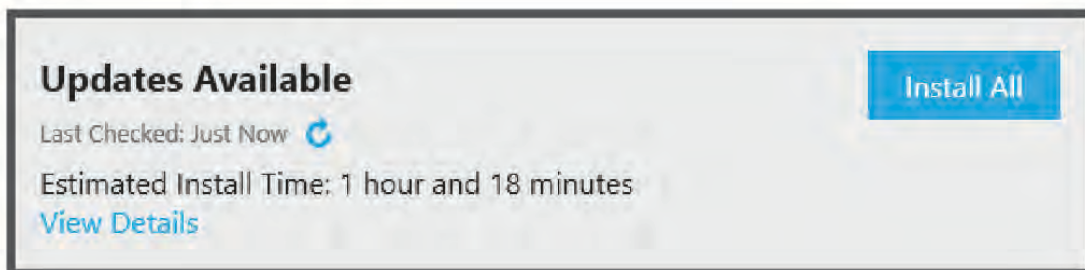

## 8 Select an option:

- To install all available updates, click **Install All**.
- To install a specific update, click **View Details**, and click **Install** next to the update you want.

The Garmin Express application downloads and installs the updates onto your device. Map updates are very large, and this process may take a long time on slower internet connections.

**NOTE:** If a map update is too large for the internal storage of the device, the software may prompt you to install a microSD card in your device to add storage space (*Installing a Memory Card for Maps and Data*, page 69).

## 9 Follow the on-screen instructions during the update process to finish installing updates.

For example, during the update process, the Garmin Express application may instruct you to disconnect and reconnect your device.

## Installing Garmin Express

The Garmin Express application is available for Windows® and Mac® computers.

### 1 On your computer, go to [garmin.com/express](http://garmin.com/express).

### 2 Select an option:

- To view the system requirements and verify the Garmin Express application is compatible with your computer, select **System Requirements**.
- To install on a Windows computer, select **Download for Windows**.
- To install on a Mac computer, select **Download for Mac**.

### 3 Open the downloaded file, and follow the on-screen instructions to complete the installation.

## Device Care

### NOTICE

Avoid dropping your device.

Do not store the device where prolonged exposure to extreme temperatures can occur, because it can cause permanent damage.

Never use a hard or sharp object to operate the touchscreen, or damage may result.

Do not expose the device to water.

## Cleaning the Outer Casing

### NOTICE

Avoid chemical cleaners and solvents that can damage plastic components.

- 1 Clean the outer casing of the device (not the touchscreen) using a cloth dampened with a mild detergent solution.
- 2 Wipe the device dry.

## Cleaning the Touchscreen

- 1 Use a soft, clean, lint-free cloth.
- 2 If necessary, lightly dampen the cloth with water.
- 3 If using a dampened cloth, turn off the device and disconnect the device from power.
- 4 Gently wipe the screen with the cloth.

## Cleaning the Camera Lens

### NOTICE

Avoid chemical cleaners and solvents that can damage plastic components.

You should clean the camera lens regularly to improve the quality of recorded video.

- 1 Wipe the lens with a non-scratch lens cloth, optionally dampened with isopropyl alcohol.
- 2 Allow the lens to air dry.

## Avoiding Theft

- Remove the device and mount from sight when not in use.
- Remove the residue left on the windshield by the suction cup.
- Do not keep your unit in the glove compartment.
- Register your device using the Garmin Express software ([garmin.com/express](http://garmin.com/express)).

## Restarting the Device

You can restart your device if it stops functioning.

Hold the power key for 12 seconds.

## Removing the Device, Mount, and Suction Cup

### Removing the Device from the Mount

- 1 Press the release tab or button on the mount.
- 2 Tilt the top of the device downward, and lift the device from the mount.

### Removing the Mount from the Suction Cup

- 1 Turn the device mount to the right or left.
- 2 Apply pressure until the socket on the mount releases the ball on the suction cup.

### Removing the Suction Cup from the Windshield

- 1 Flip the lever on the suction cup toward you.
- 2 Pull the tab on the suction cup toward you.

## Data Management

The device has a memory card slot for additional data storage.

**NOTE:** The device is compatible with Windows 7 and newer, and Mac OS 10.7 and newer.

## About Memory Cards

You can purchase memory cards from an electronics supplier, or purchase pre-loaded Garmin mapping software ([www.garmin.com](http://www.garmin.com)). Memory cards can be used to store files such as maps and custom POIs.



## Formatting the Dash Cam Memory Card

The dash cam requires a memory card formatted using the FAT32 file system. You can use the device to format your card using this file system.

You should format your memory card at least one time every 6 months to help extend the useful life of the memory card. You must also format a brand new memory card if it is not formatted using the FAT32 file system.

**NOTE:** Formatting the memory card deletes all data on the card.

- 1 Select  > **Gallery**.
- 2 Select  > **Format Memory Card**.

## Connecting the Device to Your Computer

You can connect the device to your computer using a USB cable.

- 1 Plug the small end of the USB cable into the port on the device.
- 2 Plug the larger end of the USB cable into a port on your computer.
- 3 From your dēzlCam device, select **Tap to Connect to Computer**.
- 4 When your dēzlCam device prompts you to enter file transfer mode, select **Continue**.

A picture of your device connected to a computer appears on the device screen.

Depending on your computer operating system, the device appears as either a portable device, a removable drive, or a removable volume.

## Transferring Data From Your Computer

- 1 Connect the device to your computer ([Connecting the Device to Your Computer, page 67](#)).  
Depending on your computer operating system, the device appears as either a portable device, a removable drive, or a removable volume.
- 2 On your computer, open the file browser.
- 3 Select a file.
- 4 Select **Edit > Copy**.
- 5 Browse to a folder on the device.  
**NOTE:** For a removable drive or volume, you should not place files in the Garmin folder.
- 6 Select **Edit > Paste**.

## Disconnecting the USB Cable

If your device is connected to your computer as a removable drive or volume, you must safely disconnect your device from your computer to avoid data loss. If your device is connected to your Windows computer as a portable device, it is not necessary to safely disconnect the device.

- 1 Complete an action:
  - For Windows computers, select the **Safely Remove Hardware** icon in the system tray, and select your device.
  - For Apple® computers, select the device, and select **File > Eject**.
- 2 Disconnect the cable from your computer.

# Troubleshooting

## My video recordings are blurry

- Clean the camera lens ([Cleaning the Camera Lens, page 66](#)).
- Clean the windshield in front of the camera.
- Verify the area of the windshield in front of the camera is cleared by the windshield wipers, and move the device, if necessary.

## My memory card has degraded and needs to be replaced

All microSD memory cards wear out after they are overwritten a large number of times. Periodically formatting the card can extend the useful life and improve performance. Because the dash camera records continuously, you may need to replace the memory card periodically. Your device detects memory card errors automatically and alerts you when it is time to format or replace your memory card.

You can take these actions to help extend the useful life of the memory card.

- Format the memory card at least one time every six months.
- If the device displays a memory card error alert, first try formatting the memory card and then, if necessary, replace the memory card.

- Turn off the device when your vehicle is not in use.

If your device is not connected to an ignition-switched vehicle power outlet, you should turn off the device when your vehicle is not in use to prevent the dash camera from recording unneeded footage.

- Use a memory card with a higher storage capacity.  
Because higher-capacity memory cards are overwritten less frequently, they usually last longer.
- Use a high-quality memory card with a speed rating of class 10 or higher.
- Purchase your replacement memory card from a high-quality manufacturer and a reputable vendor.

## My video recordings are choppy or incomplete

- For the best camera and video results, use a high-quality memory card with a speed rating of class 10 or higher.

A slower memory card may not record video quickly enough.

- If you are viewing videos on your smartphone using a wireless connection to the camera, try viewing them in another location with less wireless interference, or try transferring videos to the smartphone.
- Transfer important recordings to a computer or smartphone, and format the memory card.
- If the device displays a memory card error alert, first try formatting the memory card and then, if necessary, replace the memory card.
- Update your device to the latest software ([Map and Software Updates, page 62](#)).

## The suction cup will not stay on my windshield

- 1 Clean the suction cup and windshield with rubbing alcohol.
- 2 Dry with a clean, dry cloth.
- 3 Mount the suction cup ([Mounting Considerations, page 2](#)).

## My device is not acquiring satellite signals

- Verify the GPS simulator is turned off ([Navigation Settings, page 58](#)).
- Take your device out of parking garages and away from tall buildings and trees.
- Remain stationary for several minutes.

## The device does not charge in my vehicle

- Verify the vehicle is turned on and is supplying power to the power outlet.
- Verify the interior temperature of the vehicle is within the charging temperature range indicated in the specifications.
- In the vehicle fuse box, verify the fuse for the vehicle power outlet is not broken.

## My battery does not stay charged for very long

- Decrease the screen brightness (*Display Settings, page 60*).
- Shorten the display timeout (*Display Settings, page 60*).
- Decrease the volume (*Adjusting the Volume, page 7*).
- Turn off the wi-fi radio when it is not in use (*Wireless Network Settings, page 59*).
- Put the device in power saving mode when not in use.
- Keep your device away from extreme temperatures.
- Do not leave your device in direct sunlight.

## My device does not connect to my phone

- Select  > **Wireless Networks** > **Bluetooth**.  
The Bluetooth option must be enabled.
- Enable Bluetooth wireless technology on your phone and bring your phone within 10 m (33 ft.) of the device.
- Verify your phone is compatible.  
Go to [www.garmin.com/bluetooth](http://www.garmin.com/bluetooth) for more information.
- Complete the pairing process again.  
To repeat the pairing process, you must unpair your phone and device (*Deleting a Paired Phone, page 41*), and complete the pairing process (*Live Services, Traffic, and Smartphone Features, page 36*).

# Appendix

## Installing a Memory Card for Maps and Data

You can install a memory card to increase the storage space for maps and other data on your device. You can purchase memory cards from an electronics supplier. The device supports microSD memory cards from 4 to 256 GB. Memory cards must use the FAT32 file system format. Memory cards greater than 32 GB must be formatted using the device.

- 1 Locate the map and data memory card slot on your device (*dēzlCam Device Overview, page 1*).
- 2 Insert a memory card into the slot.
- 3 Press it in until it clicks.

## Viewing GPS Signal Status

Hold  for three seconds.

## Purchasing Additional Maps

- 1 Go to your device product page at [garmin.com](http://garmin.com).
- 2 Click the **Maps** tab.
- 3 Follow the on-screen instructions.

## Purchasing Accessories

- Optional accessories are available at [garmin.com](http://garmin.com) or from your Garmin dealer.

## European Emission Standards

The European Emission Standards are standards for exhaust emissions that limit the amount of air pollutants that are released from new vehicles sold in Europe.

You can find your vehicle's emission standards in your vehicle's owner's manual, your vehicle registration documents, or printed on your vehicle's door frame. If you are unable to locate the emission standard for your vehicle, you can contact your vehicle dealer or manufacturer for more information.

## Garmin PowerSwitch

### ⚠ WARNING

Garmin strongly recommends having an experienced installer with the proper knowledge of electrical systems install the device. Incorrectly wiring the power cable can result in damage to the vehicle or the battery and can cause bodily injury.

You can use a connected Garmin PowerSwitch device to control lights, fans, and more from your dēzlCam device.

### Mounting Considerations

- The device must be mounted close to the battery and within the range of the supplied power cable.
- The mounting surface must be strong enough to support the weight of the device.
- The location must allow room for the routing and connection of all cables.

### Mounting the Device

Before you can mount the device, you must select a mounting location and purchase the appropriate hardware for your mounting surface.

### NOTICE

Avoid wires, gauges, air bags, air bag covers, HVAC, and other items when drilling pilot holes and attaching the mount to the vehicle. Garmin is not responsible for any damages or consequences arising from the installation.

- 1 Place the mount on the selected location.



- 2 Using the mount as a template, mark the two screw locations ①.
- 3 Drill pilot holes (optional).  
For some types of mounting material, drilling pilot holes is necessary. Do not drill through the mount.
- 4 Securely fasten the mount to the surface using the appropriate hardware for your mounting surface.

## Opening the Front Cover

You must open the front cover to make electrical connections.

- 1 Lift the front cover latch ① and rotate it counter-clockwise.



- 2 Pull the front cover off of the device.



## Connecting Accessories

### NOTICE

Do not use the device to control or power a winch. Failure to follow this notice could cause damage to your vehicle or your device.

Do not connect a power source to an accessory output terminal. Failure to follow this notice could cause damage to your vehicle or your device.

Accessory requirements:

- Verify the amperage rating of each accessory before wiring it to the Garmin PowerSwitch device. The device supports accessories up to 30 A for each channel and a maximum of 100 A for the entire system.
- Use 10 AWG (6 mm<sup>2</sup>) wires for accessories that use 20 to 30 A.
- Use 12 AWG (4 mm<sup>2</sup>) wires for accessories that use 10 to 20 A.
- Use 14 AWG (2.5 mm<sup>2</sup>) wires for accessories that use less than 10 A.
- Use the appropriate size terminals for all accessory connections.
- Crimp all terminal connectors securely.

- 1 Connect the positive wire from the accessory ① to one of the accessory terminals ② on the Garmin PowerSwitch device.

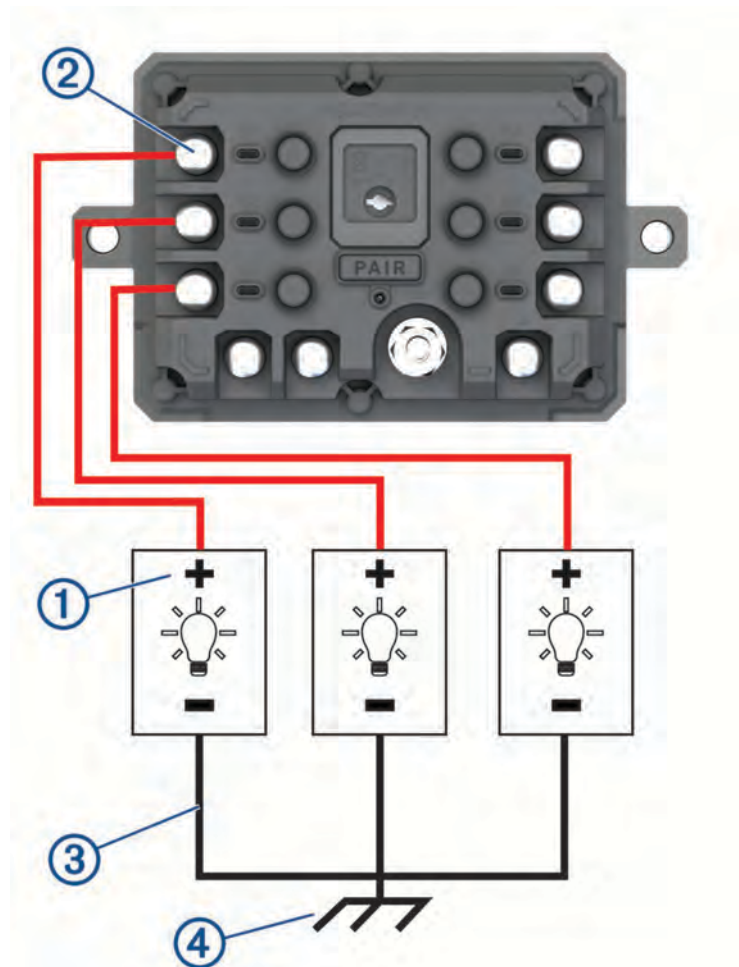

- 2 Connect the negative or ground wire ③ to an unpainted ground stud ④ on the vehicle frame, to a ground distribution block, or directly to the negative terminal on the battery.

### ⚠ CAUTION

Do not connect the accessory ground wires to the ground terminal (GND) on the Garmin PowerSwitch device, as doing so could result in personal injury or property damage, or could negatively impact device functionality.

- 3 Verify that all electrical connections are tight and will not come loose during use.

### Connecting a Control Input

You can connect to the control terminals to enable the Garmin PowerSwitch device to turn on customizable outputs. For example, you can connect your vehicle ignition switch to a control input terminal to turn on accessories automatically each time you start your vehicle. The control terminals detect a signal from 3.3 V to 18 V. You can configure output functions with the Garmin PowerSwitch app.

Connect the control wire from the control source in your vehicle to one of the two control terminals on the Garmin PowerSwitch device.

### Connecting the Device to Vehicle Power

Before you can connect the device to vehicle power, you must remove the warning tag from the +12V terminal on the device.

You should always confirm all electrical connections are secure and will not come loose while operating the device.

- 1 Connect the large ring end of the included ground wire ① to the negative terminal on the vehicle battery.

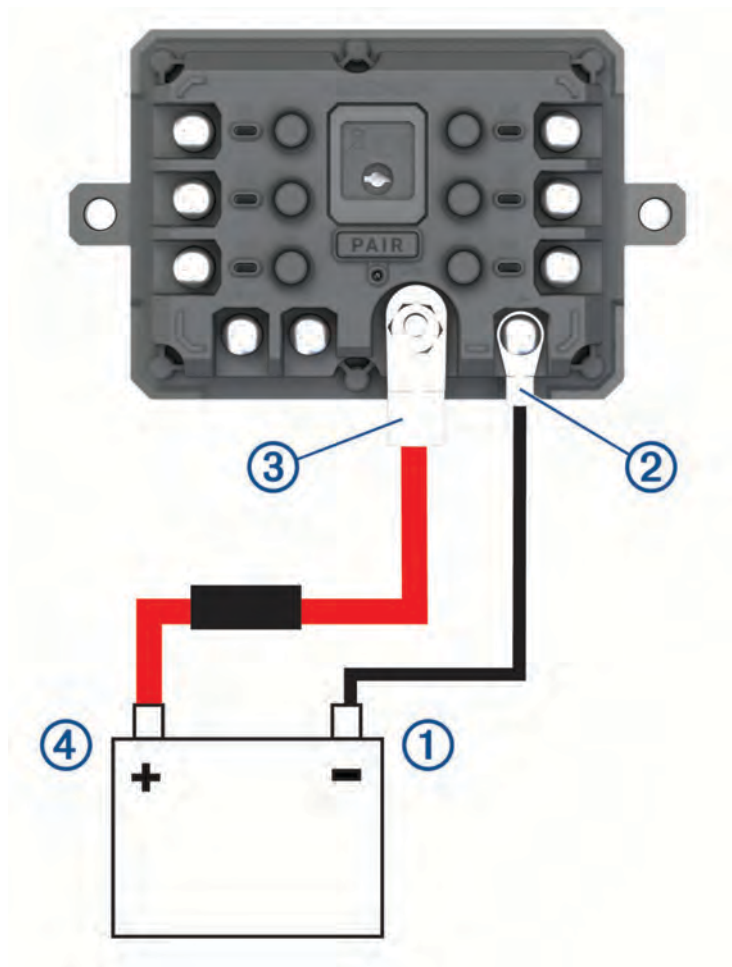

- 2 Connect the small ring end of the ground wire to the **GND** terminal ② on the device.
- 3 Connect the small ring end of the included 12V cable to the **+12V** terminal ③ on the device.

- 4 Tighten the  $\frac{3}{8}$  in. nut on the +12V terminal to a maximum torque specification of 4.52 N-m (40 lbf-in.). You should confirm the nut cannot be loosened by hand.

#### NOTICE

Do not overtighten the +12V terminal to prevent damage to the terminal.

- 5 Connect the large ring end of the 12V cable ④ to the positive terminal on the vehicle battery.

## Pairing with a Garmin Navigation Device

You can pair your Garmin PowerSwitch device with a compatible Garmin navigation device.

- 1 Turn on power to your Garmin PowerSwitch device, and place your compatible Garmin navigation device within 1 m (3.3 ft.) of it.
- 2 On your compatible navigation device, open the Garmin PowerSwitch app.
- 3 Follow the on-screen instructions to complete the pairing and setup process.

The main app dashboard appears. After the devices are paired, they connect automatically when they are turned on and within range.

## Garmin PowerSwitch Specifications

Dimensions (D x W x H)	75 x 125 x 32 mm (2.95 x 4.92 x 1.26 in.)
Operating temperature range	From -25° to 85°C (from -13° to 185°F)
Wireless frequency	2.4 GHz @ 13 dBm
Power input	From 12 to 16 V using the included vehicle power cable.
Maximum accessory output	30 A
Maximum system output	100 A
Current draw with all outputs off	3 mA
Water rating	IEC 60529 IPX7 <sup>1</sup>

## Troubleshooting

### My Garmin PowerSwitch will not stay connected

- Verify the Garmin PowerSwitch device is receiving power.
- Verify that Bluetooth technology is enabled on your paired navigation device or smartphone.
- Move the navigation device or smartphone closer to your Garmin PowerSwitch device.
- Verify that your vehicle's battery is supplying at least 12 V of power.

The Garmin PowerSwitch device turns off all outputs automatically to preserve your vehicle's battery if it is receiving less than 11 V of power (*My accessories are not receiving power*, page 75).

<sup>1</sup> The device withstands incidental exposure to water of up to 1 m for up to 30 min. For more information, go to [www.garmin.com/waterrating](http://www.garmin.com/waterrating).



### **My accessories are not receiving power**

- Verify the Garmin PowerSwitch device is receiving power from the vehicle battery.
- Verify that your vehicle's battery is supplying at least 12 V of power.

The Garmin PowerSwitch device turns off all outputs automatically to preserve your vehicle's battery if it is receiving less than 11 V of power. Outputs turn back on when the device detects more than 12 V of power.

- Verify that all electrical connections are secure and will not come loose while operating the vehicle.
- Verify that each connected accessory draws less than 30 A.

If an accessory draws more than 30 A, the device turns off that output automatically.

- Verify that the total system load is less than 100 A.

If the device detects a system load of more than 100 A, it turns off all outputs automatically.

- Inspect all electrical connections for an electrical short circuit.

