

2009-05-14 14:25:48 RM547-RM566 User guide publication 2

# Nokia 6730 classic User Guide

---

D  
R  
A  
F  
T

9213962  
Issue draft

Cyan Magenta Yellow Black



© 2009 Nokia. All rights reserved.

DECLARATION OF CONFORMITY

**CE 0434** Hereby, NOKIA CORPORATION declares that this RM-566 product is in compliance with the essential requirements and other relevant provisions of Directive 1999/5/EC. A copy of the Declaration of Conformity can be found at [www.nokia.com/phones/declaration\\_of\\_conformity/](http://www.nokia.com/phones/declaration_of_conformity/).

Nokia, Nokia Connecting People, Navi, OVI, and Nokia Original Enhancements logo are trademarks or registered trademarks of Nokia Corporation. Nokia tune is a sound mark of Nokia Corporation. Other product and company names mentioned herein may be trademarks or tradenames of their respective owners.

Reproduction, transfer, distribution, or storage of part or all of the contents in this document in any form without the prior written permission of Nokia is prohibited.

**symbian** This product includes software licensed from Symbian Software Ltd ©1998-2008. Symbian and Symbian OS are trademarks of Symbian Ltd.



**Java**  
POWERED Java and all Java-based marks are trademarks or registered trademarks of Sun Microsystems, Inc.

Portions of the Nokia Maps software are ©1996-2008 The FreeType Project. All rights reserved.

This product is licensed under the MPEG-4 Visual Patent Portfolio License (i) for personal and noncommercial use in connection with information which has been encoded in compliance with the MPEG-4 Visual Standard by a consumer engaged in a personal and noncommercial activity and (ii) for use in connection with MPEG-4 video provided by a licensed video provider. No license is granted or shall be implied for any other use. Additional information, including that related to promotional, internal, and commercial uses, may be obtained from MPEG LA, LLC. See <http://www.mpegla.com>

TO THE MAXIMUM EXTENT PERMITTED BY APPLICABLE LAW, UNDER NO CIRCUMSTANCES SHALL NOKIA OR ANY OF ITS LICENSORS BE RESPONSIBLE FOR ANY LOSS OF DATA OR INCOME OR ANY SPECIAL, INCIDENTAL, CONSEQUENTIAL OR INDIRECT DAMAGES HOWSOEVER CAUSED.

THE CONTENTS OF THIS DOCUMENT ARE PROVIDED "AS IS". EXCEPT AS REQUIRED BY APPLICABLE LAW, NO WARRANTIES OF ANY KIND, EITHER EXPRESS OR IMPLIED, INCLUDING, BUT NOT LIMITED TO, THE IMPLIED WARRANTIES OF MERCHANTABILITY AND FITNESS FOR A PARTICULAR PURPOSE, ARE MADE IN RELATION TO THE ACCURACY, RELIABILITY OR CONTENTS OF THIS DOCUMENT. NOKIA RESERVES THE RIGHT TO REVISE THIS DOCUMENT OR WITHDRAW IT AT ANY TIME WITHOUT PRIOR NOTICE.

Reverse engineering of any software in the Nokia device is prohibited to the extent permitted by applicable law. Insofar as this user guide contains any limitations on Nokia's representations, warranties, damages and liabilities, such limitations shall likewise limit any representations, warranties, damages and liabilities of Nokia's licensors.

2009-05-14 14:25:48 RM547-RM566 User guide publication 2

The availability of particular products and applications and services for these products may vary by region. Please check with your Nokia dealer for details, and availability of language options.

**FCC/INDUSTRY CANADA NOTICE**

Your device may cause TV or radio interference (for example, when using a telephone in close proximity to receiving equipment). The FCC or Industry Canada can require you to stop using your telephone if such interference cannot be eliminated. If you require assistance, contact your local service facility. This device complies with part 15 of the FCC rules. Operation is subject to the following two conditions: (1) This device may not cause harmful interference, and (2) this device must accept any interference received, including interference that may cause undesired operation. Any changes or modifications not expressly approved by Nokia could void the user's authority to operate this equipment.

9213962/Issue draft EN

D  
R  
A  
F  
T



## Contents

|                                   |           |  |           |
|-----------------------------------|-----------|--|-----------|
| <b>Safety</b> .....               | <b>7</b>  | Connect a USB data cable.....              | 18        |
| About your device.....            | 7         | Wrist strap.....                           | 18        |
| Network services.....             | 8         | <b>3. Support</b> .....                    | <b>18</b> |
| <b>1. Get started</b> .....       | <b>9</b>  | In-device help.....                        | 18        |
| Insert SIM card and battery.....  | 9         | My Nokia.....                              | 19        |
| Insert a memory card.....         | 9         | Nokia support and contact information..... | 19        |
| Remove a memory card.....         | 10        | Software updates.....                      | 19        |
| Charge the battery.....           | 10        | <b>4. Call functions</b> .....             | <b>20</b> |
| Switch the device on and off..... | 11        | Voice calls.....                           | 20        |
| Antenna locations.....            | 11        | Video calls.....                           | 22        |
| Configuration settings.....       | 11        | Call settings.....                         | 23        |
| Settings wizard.....              | 12        | Video sharing.....                         | 25        |
| <b>2. Your device</b> .....       | <b>12</b> | <b>5. Music</b> .....                      | <b>26</b> |
| Keys and parts.....               | 12        | Music player.....                          | 26        |
| Own key.....                      | 13        | FM Radio.....                              | 27        |
| Home screen.....                  | 13        | <b>6. Positioning</b> .....                | <b>28</b> |
| Offline profile.....              | 14        | About GPS.....                             | 28        |
| Display indicators.....           | 14        | Assisted GPS (A-GPS).....                  | 28        |
| Power saver.....                  | 15        | Maps.....                                  | 29        |
| Menu.....                         | 15        | Landmarks.....                             | 30        |
| Volume control.....               | 16        | GPS data.....                              | 30        |
| Keypad lock (keyguard).....       | 16        | About Nokia Sports Tracker.....            | 31        |
| Access codes.....                 | 16        | <b>7. Write text</b> .....                 | <b>31</b> |
| Remote lock.....                  | 17        | Traditional text input.....                | 31        |
| About Download!.....              | 17        |  |           |
| Installations.....                | 17        |  |           |
| Connect a compatible headset..... | 17        |  |           |

**Contents**

|  |           |                                     |           |
|--|-----------|-------------------------------------|-----------|
| Predictive text input.....                             | 32        | <b>13. Personalisation.....</b>     | <b>46</b> |
| Change the writing language.....                       | 32        | Themes.....                         | 46        |
| Copy and delete text.....                              | 33        | Profiles .....                      | 46        |
| <b>8. Messaging.....</b>                               | <b>33</b> | <b>14. Time management.....</b>     | <b>47</b> |
| Write and send messages.....                           | 33        | Calendar.....                       | 47        |
| E-mail.....  | 35        | Alarm clock.....                    | 48        |
| <b>9. Contacts.....</b>                                | <b>37</b> | Clock settings.....                 | 48        |
| Manage names and numbers.....                          | 38        | <b>15. Office applications.....</b> | <b>48</b> |
| Save and edit names and numbers.....                   | 38        | PDF reader.....                     | 48        |
| Ringing tones, images, and call text for contacts..... | 38        | Dictionary.....                     | 48        |
| Copy contacts.....                                     | 38        | About Quickoffice.....              | 49        |
| <b>10. Gallery.....</b>                                | <b>38</b> | Converter.....                      | 49        |
| About Photos.....                                      | 39        | Calculator.....                     | 50        |
| <b>11. Camera.....</b>                                 | <b>39</b> | Active notes .....                  | 50        |
| Capture an image.....                                  | 39        | Notes.....                          | 51        |
| Record videos.....                                     | 40        | Zip manager.....                    | 51        |
| <b>12. Internet.....</b>                               | <b>40</b> | <b>16. Settings.....</b>            | <b>51</b> |
| Web browser .....                                      | 40        | Application settings.....           | 52        |
| Connect PC to web.....                                 | 42        | Device and SIM card security.....   | 52        |
| About Contacts on Ovi.....                             | 42        | Common accessory settings.....      | 52        |
| Ovi Files.....   | 43        | Restore original settings.....      | 52        |
| Nokia Music Store.....                                 | 43        | <b>17. Data management.....</b>     | <b>53</b> |
| Share online.....                                      | 43        | Install or remove applications..... | 53        |
| Nokia Video Centre.....                                | 44        | File manager.....                   | 54        |
| Search.....  | 46        | Device manager.....                 | 55        |
|  |           | Update device software.....         | 56        |

**Contents**

|  |           |                   |           |
|--|-----------|-------------------|-----------|
| <b>18. Connectivity.....</b>                 | <b>56</b> | <b>Index.....</b> | <b>69</b> |
| Transfer content from another device.....    | 56        |                   |           |
| PC connections.....                          | 57        |                   |           |
| Bluetooth.....                               | 57        |                   |           |
| Data cable.....                              | 60        |                   |           |
| Sync.....                                    | 60        |                   |           |
| <b>19. Green tips.....</b>                   | <b>61</b> |                   |           |
| Save energy.....                             | 61        |                   |           |
| Recycle.....                                 | 61        |                   |           |
| Save paper.....                              | 61        |                   |           |
| Learn more.....                              | 62        |                   |           |
| <b>Accessories.....</b>                      | <b>63</b> |                   |           |
| <b>Battery.....</b>                          | <b>63</b> |                   |           |
| Battery and charger information.....         | 63        |                   |           |
| Nokia battery authentication guidelines..... | 64        |                   |           |
| <b>Taking care of your device.....</b>       | <b>64</b> |                   |           |
| Recycle.....                                 | 65        |                   |           |
| <b>Additional safety information.....</b>    | <b>66</b> |                   |           |
| Small children.....                          | 66        |                   |           |
| Operating environment.....                   | 66        |                   |           |
| Medical devices.....                         | 66        |                   |           |
| Vehicles.....                                | 67        |                   |           |
| Potentially explosive environments.....      | 67        |                   |           |
| Emergency calls.....                         | 67        |                   |           |
| Certification information (SAR).....         | 68        |                   |           |

## Safety

Read these simple guidelines. Not following them may be dangerous or illegal. Read the complete user guide for further information.



### SWITCH ON SAFELY

Do not switch the device on when wireless phone use is prohibited or when it may cause interference or danger.



### ROAD SAFETY COMES FIRST

Obey all local laws. Always keep your hands free to operate the vehicle while driving. Your first consideration while driving should be road safety.



### INTERFERENCE

All wireless devices may be susceptible to interference, which could affect performance.



### SWITCH OFF IN RESTRICTED AREAS

Follow any restrictions. Switch the device off in aircraft, near medical equipment, fuel, chemicals, or blasting areas.



### QUALIFIED SERVICE

Only qualified personnel may install or repair this product.



### ACCESSORIES AND BATTERIES

Use only approved accessories and batteries. Do not connect incompatible products.



### WATER-RESISTANCE

Your device is not water-resistant. Keep it dry.

## About your device

The wireless device described in this guide is approved for use on the (E)GSM 850, 900, 1800 and 1900 networks, and UMTS 900 and 2100 HSDPA and HSUPA networks. Contact your service provider for more information about networks.

When using this device, obey all laws and respect local customs, privacy and legitimate rights of others, including copyrights. Copyright protection may prevent some images, music (including ringing tones), and other content from being copied, modified, or transferred.

Your device supports several methods of connectivity. Like computers, your device may be exposed to viruses and other harmful content. Exercise caution with messages, connectivity requests, browsing, and downloads. Only install and use services and other software from trustworthy sources that offer adequate security and protection against harmful software, such as applications that are Symbian Signed or have passed the Java Verified™ testing. Consider installing antivirus and other security software on your device and any connected computer.

Your device may have preinstalled bookmarks and links for third-party internet sites. You may also access other third-

## Safety

party sites through your device. Third-party sites are not affiliated with Nokia, and Nokia does not endorse or assume liability for them. If you choose to access such sites, you should take precautions for security or content.

 **Warning:** To use any features in this device, other than the alarm clock, the device must be switched on. Do not switch the device on when wireless device use may cause interference or danger.

Make back-up copies or keep a written record of all important information stored in your device.

When connecting to any other device, read its user guide for detailed safety instructions. Do not connect incompatible products.

The images in this guide may differ from your device display. Refer to the user guide for other important information about your device.

## Network services

To use the device you must have service from a wireless service provider. Some features are not available on all

networks; other features may require that you make specific arrangements with your service provider to use them.

Network services involve transmission of data. Check with your service provider for details about fees in your home network and when roaming on other networks. Your service provider can explain what charges will apply. Some networks may have limitations that affect how you can use some features of this device requiring network support such as support for specific technologies like WAP 2.0 protocols (HTTP and SSL) that run on TCP/IP protocols and language-dependent characters.

Your service provider may have requested that certain features be disabled or not activated in your device. If so, these features will not appear on your device menu. Your device may also have customized items such as menu names, menu order, and icons.



## 1. Get started

### Insert SIM card and battery

A USIM card is an enhanced version of the SIM card and is supported by 3G mobile devices.

1. To remove the back cover of the device, press the back cover with your fingers, slide the cover open, and lift the cover off.

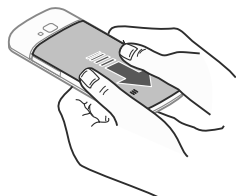

2. Slide the SIM card into the SIM card holder.

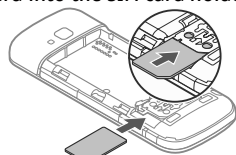

Make sure that the gold-coloured contact area on the card is facing down on the device, and the bevelled corner is facing away from the card holder slot.

3. Insert the battery.

4. Replace the back cover.

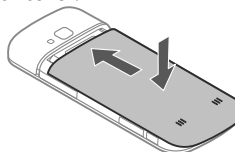

**Important:** To prevent damage to the SIM card, always remove the battery before you insert or remove the card.

Switch the device off and disconnect the charger before removing the battery.

### Insert a memory card

The memory card may be supplied with the device, and may already be inserted.

1. Open the memory card slot cover (1).

### Get started

2. Place the card in the slot with the contact area facing down (2).
3. Push the card gently to lock it into place. Close the slot cover (3).

Use only compatible microSD cards approved by Nokia for use with this device. Nokia uses approved industry standards for memory cards, but some brands may not be fully compatible with this device. Incompatible cards may damage the card and the device and corrupt data stored on the card.

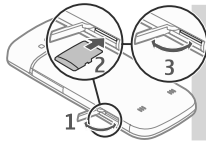

### Remove a memory card

 **Important:** Do not remove the memory card in the middle of an operation when the card is being accessed. Removing the card in the middle of an operation may damage the memory card as well as the device, and data stored on the card may be corrupted.

1. Press the power key briefly, and select **Remove memory card** > **Yes**.
2. Open the memory card slot cover.
3. Press the memory card gently to release it.
4. Pull the card out, and select **OK**.
5. Close the slot cover.

### Charge the battery

Your battery has been partially charged at the factory. If the device indicates a low charge, do the following:

1. Connect the charger to a wall outlet.
2. Connect the charger to the device.

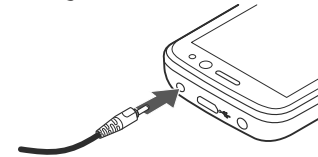

3. When the battery is fully charged, disconnect the charger from the device, then from the wall outlet.

You do not need to charge the battery for a specific length of time, and you can use the device while it is charging. If the battery is completely discharged, it may take several minutes before the charging indicator appears on the display or before any calls can be made.

 **Tip:** If you have old compatible Nokia chargers, you can use them with your device by attaching the CA-44 charger adapter to the old charger. The adapter is available as a separate accessory.

### USB charging

You can use USB charging when a wall outlet is not available. When charging your device with the USB data cable, the charging time is longer. USB charging efficiency varies significantly. In some cases, it may take a very long time for charging to start and the device to start functioning.

With USB charging, you can also transfer data with the USB data cable while charging the device.

1. Connect a compatible USB device to your device using a compatible USB data cable.  
Depending on the type of the device that is used for charging, it may take a while for charging to start.
2. If the device is switched on, select from the available USB mode options on the display of the device.

### Switch the device on and off

Press and hold the power key to switch the device on and off. Press the power key briefly to end a call or close an application.

If the device asks for a PIN code, enter the PIN code, and select **OK**.

If the device asks for the lock code, enter the lock code, and select **OK**. The factory setting for the lock code is 12345.

To set the correct time zone, time, and date, select the country you are presently in, then enter the local time and date.

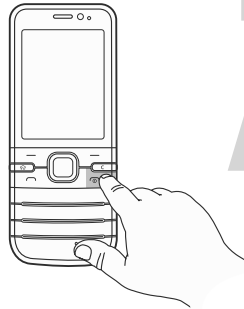

### Antenna locations

Your device may have internal and external antennas. As with any radio transmitting device, avoid touching the antenna area unnecessarily while the antenna is transmitting or receiving. Contact with such an antenna affects the communication quality and may cause the device to operate at a higher power level than otherwise needed and may reduce the battery life.



### Configuration settings

Before you can use multimedia messaging, e-mail, synchronisation, streaming, and the browser, you must have the proper configuration settings in your device. Your device may automatically configure browser, multimedia messaging, access point, and streaming settings based on the SIM card used. If not, you can use the Settings wizard application to configure the settings. You may receive the settings as a configuration message that you can save to your device. For more information on availability, contact your service provider or nearest authorised Nokia dealer.

### Your device

When you receive a configuration message, and the settings are not automatically saved and activated, **1 new message** is displayed. To save the settings, select **Show > Options > Save**. You may need to enter a PIN code provided by the service provider.

### Settings wizard

Select  > **Settings** > **Sett. wizard**.

Use Settings wizard to define e-mail and connection settings. The availability of the items in Settings wizard depends on the features of the device, SIM card, network operator, and the data in the Settings wizard database.

To start Settings wizard, select **Start**.

To get the best results when using the settings wizard, keep your SIM card inserted in the device. If the SIM card is not inserted, follow the instructions on the display.

Select from the following:

- **Operator** — Define the operator-specific settings, such as MMS, internet, WAP, and streaming settings.
- **E-mail setup** — Create a new mailbox.
- **Video sharing** — Configure video sharing settings.

The settings available for editing may vary.

## 2. Your device

### Keys and parts

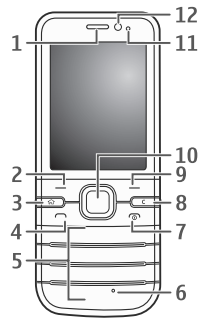

- 1 — Earpiece
- 2 — Left selection key
- 3 — Home key
- 4 — Call key
- 5 — Number keys
- 6 — Microphone
- 7 — End/Power key
- 8 — Clear key **C**
- 9 — Right selection key
- 10 — Navi™ key; hereafter referred to as scroll key
- 11 — Light sensor

## Your device

12 — Secondary camera lens

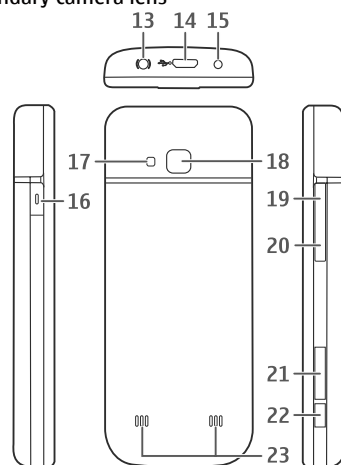

13 — Nokia AV connector (2.5 mm)

14 — Micro USB connector

15 — Charger connector

16 — Own key

17 — Camera flash

18 — Main camera lens

19 — Volume up key

20 — Volume down key

21 — Memory card slot

22 — Capture key

23 — Loudspeaker

The surface of this device is nickel-free.

## Own key

You can change the function that is activated when you press the Own key. For example, you can set the key to open an application or a web page.

To change the function, select  > **Settings** > **Settings** and **General** > **Own key** > **Change**.

## Home screen

When you have switched on the device, and it is registered to a network, the device is in the home screen and ready for use.

To open a list of most recently dialled numbers, press the call key.

To use voice commands or voice dialling, press and hold the right selection key.

To change the profile, press the power key briefly, and select a profile.

To open a connection to the web, press and hold **0**.

To activate or deactivate Bluetooth connectivity, press and hold **\***.

**Your device**

To modify the home screen, select  > **Settings** > **Settings** and **General** > **Personalisation** > **Standby mode** and from the available options.

**Offline profile**

To quickly activate the Offline profile, press the power key briefly, and select **Offline**.











To switch to another profile, press the power key briefly, and select a profile.

When the Offline profile is active, all connections that use radio frequencies are closed. However, you can use your device without the SIM card and listen to the radio or music. Remember to switch off your device when wireless phone use is prohibited.















 **Important:** In the offline profile you cannot make or receive any calls, or use other features that require cellular network coverage. Calls may still be possible to the official emergency number programmed into your device. To make calls, you must first activate the phone function by changing profiles. If the device has been locked, enter the lock code.





**Display indicators**

 The device is being used in a UMTS network or a GSM network (network service). The bar next to the icon indicates the signal strength of the network at your current location. The higher the bar, the stronger the signal.

-  High-speed downlink packet access (HSDPA) / high-speed uplink packet access (HSUPA) (network service) in the UMTS network is activated.
-  The device is using the Offline profile and is not connected to a cellular network.
-  The battery charge level. The higher the bar, the stronger the charge in the battery.
-  You have unread messages in the Inbox folder in Messaging.
-  You have received new e-mail in the remote mailbox.
-  There are messages waiting to be sent in the Outbox folder in Messaging.
-  You have missed calls.
-  The keys of the device are locked.
-  An alarm is active.
-  You have activated the Silent profile, and the device does not ring for an incoming call or message.

**Your device**

-  Bluetooth connectivity is activated.
-  A Bluetooth connection is established. When the indicator is blinking, your device is trying to connect with another device.
-  A GPRS packet data connection is available (network service).  indicates that the connection is active.  indicates that the connection is on hold.
-  An EGPRS packet data connection is available (network service).  indicates that the connection is active.  indicates that the connection is on hold.
-  A UMTS packet data connection is available (network service).  indicates that the connection is active.  indicates that the connection is on hold.
-  HSDPA/HSUPA is supported and available (network service). The icon may vary between regions.  indicates that the connection is active.  indicates that the connection is on hold.
-  Your device is connected to a computer with a USB data cable.

-  The second phone line is being used (network service).
  -  All calls are forwarded to another number. If you have two phone lines, a number indicates the active line.
  -  A headset or a loopset is connected to the device.
  -  A hands-free car kit is connected to the device.
  -  Your device is synchronising.
- Other indicators may also be displayed.

**Power saver**

Select  > **Settings** > **Settings**.

To define the screen saver settings, select **General** > **Personalisation** > **Display** and from the following:

- **Power saver time-out** — Set the length of time that the device is inactive before the power saver is activated.
- **Light time-out** — Set the length of time that the device is inactive before the screen is dimmed.

**Menu**

Press .

In the menu, you can access the functions in your device.

### Your device

To open an application or a folder, select the item.

If you change the order of the functions in the menu, the order may differ from the default order described in this user guide.

To mark or unmark an item in applications, press #.

To mark or unmark several consecutive items, press and hold #, and scroll up or down.

To change the menu view, select **Options > Change Menu view**.

To close an application or a folder, select **Options > Exit**.

To display and switch between open applications, press and hold the home key, and select an application.

Leaving applications running in the background increases the demand on battery power and reduces the battery life.

### Volume control

To adjust the earpiece or loudspeaker volume during a call or when listening to an audio file, use the volume keys.

To activate or deactivate the loudspeaker during a call, select **Loudsp.** or **Handset**.

 **Warning:** Listen to music at a moderate level. Continuous exposure to high volume may damage your hearing.

### Keypad lock (keyguard)

To lock the keypad in the home screen, press the left selection key and \* within 1.5 seconds.

To set the device to automatically lock the keypad after a certain time, select  > **Settings > Settings and General > Security > Phone and SIM card > Keypad autolock period > User defined**, and select the desired time.

To unlock the keypad, select **Unlock**, and press \*. When the device or keypad is locked, calls may be possible to the official emergency number programmed into your device.

### Access codes

Select  > **Settings > Settings**.

To define how your device uses the access codes and security settings, select **General > Security > Phone and SIM card** and from the following:

- The PIN (UPIN) code, supplied with the SIM (USIM) card, helps to protect the card against unauthorised use.
- The PIN2 (UPIN2) code, supplied with some SIM (USIM) cards, is required to access certain services.
- PUK (UPUK) and PUK2 (UPUK2) codes may be supplied with the SIM (USIM) card. If you enter the PIN code incorrectly three times in succession, you are asked for the PUK code. If the codes are not supplied, contact your service provider.
- The security code helps to protect your phone against unauthorised use. You can create and change the code, and set the phone to request the code. Keep the code



## Your device

secret and in a safe place separate from your phone. If you forget the code and your phone is locked, your phone will require service and additional charges may apply. For more information, contact your service provider.

- The barring password is required when using the call barring service to restrict calls to and from your phone (network service).

## Remote lock

You can lock your device from another device using a text message. To enable your device to be locked remotely, and to define the lock message to be used, select  > **Settings** > **Settings** > **General** > **Security and Phone and SIM card** > **Remote phone locking**. When you have entered the message, select **OK**. The message can be up to 20 characters long.

To lock your device, send the lock message as a text message to your mobile phone number. To unlock your device later, select **Unlock**, and enter the lock code.

## About Download!

Select  > **Download!**.

With Download!, you can discover, preview, buy, download, and upgrade content, services, and applications. Games, ringing tones, wallpapers, applications, and much more are easily accessible. The items are categorised under catalogues and folders from different service providers. The available content depends on your service provider.

Download! uses your network services to access the most up-to-date content. For information on additional items available through Download!, contact your service provider or the supplier or manufacturer of the item.

Download! receives updates continuously and provides you with the latest content your service provider offers for your device.

Items may be chargeable, but you can usually preview them free of charge. For more information about the charges, contact your service provider or the provider of the item.

To update the content in Download! manually, select **Options** > **Refresh content**.

## Installations

Select  > **Applications** > **Installations**.

You can find additional applications and download applications into this folder.

 **Important:** Only install and use applications and other software from trusted sources, such as applications that are Symbian Signed or have passed the Java Verified™ testing.

## Connect a compatible headset

Do not connect products that create an output signal as this may cause damage to the device. Do not connect any voltage source to the Nokia AV Connector.

### Support

When connecting any external device or any headset, other than those approved by Nokia for use with this device, to the Nokia AV Connector, pay special attention to volume levels.

connection mode or change the active mode, select  > **Settings and Connectivity** > **USB** > **USB connection mode**, and select the desired mode.

To select whether the default mode is activated automatically, select **Ask on connection**.

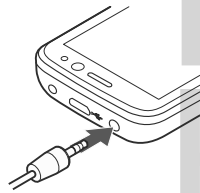

### Connect a USB data cable

Connect a compatible USB data cable to the USB connector.  
To select the default USB

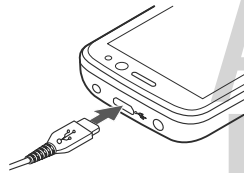

### Wrist strap

Thread the wrist strap, and tighten it.

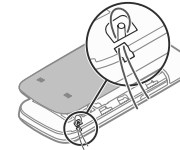

## 3. Support



### In-device help

Your device contains instructions to help to use the applications in your device.

To open help texts from the main menu, select  > **Applications** > **Help** > **Help** and the application for which you want to read instructions.

When an application is open, to access the help text for the current view, select **Options** > **Help**.

When you are reading the instructions, to change the size of the help text, select **Options > Decrease font size** or **Increase font size**.

You can find links to related topics at the end of the help text. If you select an underlined word, a short explanation is displayed. Help texts use the following indicators:  shows a link to a related help topic.  shows a link to the application being discussed.

When you are reading the instructions, to switch between help texts and the application that is open in the background, press and hold the menu key, and select from the list of open applications.

## My Nokia

My Nokia is a free service that regularly sends you text messages containing tips, tricks, and support for your Nokia device. If My Nokia is available in your country and supported by your service provider, your device invites you to join the My Nokia service after you have set the time and the date.

To sign-up to My Nokia, select **Accept** and follow the instructions on the display.

Call charges apply when you send messages to sign up or unsubscribe.

For terms and conditions, see the documentation supplied with your device or [www.nokia.com/mynokia](http://www.nokia.com/mynokia).

To sign-up to My Nokia later, select  > **Applications > Installations > My Nokia**. After the invitation to join My Nokia, the Phone setup application starts.

To open the Phone setup application later, select  > **Settings > Help > Phone setup**.

## Nokia support and contact information

Check [www.nokia.com/support](http://www.nokia.com/support) or your local Nokia Web site for the latest version of this guide, additional information, downloads, and services related to your Nokia product.

On the website, you can get information on the use of Nokia products and services. If you need to contact customer service, check the list of local Nokia contact centers at [www.nokia.com/customerservice](http://www.nokia.com/customerservice).

For maintenance services, check your nearest Nokia service center at [www.nokia.com/repair](http://www.nokia.com/repair).

## Software updates

Nokia may produce software updates that offer new features, enhanced functions, and improved performance. You may be able to request these updates through the Nokia Software Updater PC application. Software updates may not be available for all products or their variants. Not all operators may endorse the latest software versions available.

To update the device software, you need the Nokia Software Updater application and a compatible PC with Microsoft Windows 2000, XP, or Vista operating system, broadband internet access, and a compatible data cable to connect your device to the PC.

## Call functions

 **Warning:** If you install a software update, you cannot use the device, even to make emergency calls, until the installation is completed and the device is restarted. Be sure to back up data before accepting installation of an update.

The download and installation may take up to 20 minutes with Device manager and up to 30 minutes with Nokia Software Updater.

To get more information and to download the Nokia Software Updater application, visit [www.nokia.com/softwareupdate](http://www.nokia.com/softwareupdate) or your local Nokia website.

## 4. Call functions

### Voice calls

#### Make a call

 **Important:** If the device has been locked, enter the lock code to activate the phone function.

When the device is locked, calls may be possible to the official emergency number. Making an emergency call in the offline profile or when the device is locked requires that the device recognise the number to be an official emergency number. It is advisable to change the profile or unlock the device by entering the lock code before you make the emergency call.

To make a call, enter the phone number, including the area code, and press the call key.

If software updates over the air are supported by your network, you may also be able to request updates through the device.

 **Tip:** To check the software version in your device, enter **\*#0000#** in the home screen.

 **Tip:** For international calls, add the + character that replaces the international access code, and enter the country code, area code (omit the leading 0, if necessary), and phone number.

To end the call or cancel the call attempt, press the end key.

To make a call using the saved contacts, open the contacts. Enter the first letters of the name, scroll to the name, and press the call key.

To make a call using the log, press the call key to view up to 20 numbers that you last called or attempted to call. Scroll to the desired number or name, and press the call key.

To adjust the volume of an active call, use the volume keys.

**Call functions**

To switch from a voice call to a video call, select **Options** > **Switch to video call**. The device ends the voice call and makes a video call to the recipient.

**Speed dialling** 

Select  > **Settings** > **Settings and Phone** > **Call** > **Speed dialling**.

Speed dialling allows you to make a call by pressing and holding a number key in the home screen.

To activate speed dialling, select **On**.

To assign a number key to a phone number, select  > **Settings** > **Speed dial**. Scroll to the number key (2 - 9) on the display, and select **Options** > **Assign**. Select the desired number from the contacts list.

To delete the phone number assigned to a number key, scroll to the speed dialling key, and select **Options** > **Remove**.

To modify a phone number assigned to a number key, scroll to the speed dialling key, and select **Options** > **Change**.

**Voice mail** 

Select  > **Settings** > **Call mailbox**.

When you open the Voice mail application for the first time, you are asked to enter the number of your voice mailbox.

To call your voice mailbox, scroll to Voice mailbox, and select **Options** > **Call voice mailbox**.

To call your mailbox in the home screen, press and hold **1**; or press **1** and then the call key. Select the mailbox you want to call.

To change the mailbox number, select the mailbox and **Options** > **Change number**.

**Voice dialling**

Make a phone call by saying the name that is saved in the contacts list.

 **Note:** Using voice tags may be difficult in a noisy environment or during an emergency, so you should not rely solely upon voice dialling in all circumstances.

1. In the home screen, press and hold the right selection key. A short tone sounds, and **Speak now** is displayed.
2. Say the name of the contact you want to dial. If the voice recognition is successful, a list of proposed matches is displayed. The phone plays the voice command of the first match on the list. If it is not the correct command, scroll to another entry.

**Make a conference call**

1. To make a conference call, enter a participant's phone number, and press the call key.
2. When the participant answers, select **Options** > **New call**.

### Call functions

3. When you have made a phone call to all the participants, select **Options > Conference** to merge the calls into a conference call.

To mute the microphone of your device during the call, select **Options > Mute**.

To drop a participant from the conference call, scroll to the participant, and select **Options > Conference > Drop participant**.

To discuss privately with a conference call participant, scroll to the participant, and select **Options > Conference > Private**.

### Answer a call

To answer a call, press the call key.

To reject a call, press the end key.

To mute the ringing tone instead of answering a call, select **Silence**.

When you have an active call and the call waiting function (network service) is activated, press the call key to answer a new incoming call. The first call is put on hold. To end the active call, press the end key.

### Call and data registers

Select  > **Log**.

To view recently missed, received, and dialled calls, select **Recent calls**.



**Tip:** To view the dialled numbers when in the home screen, press the call key.

To view the approximate duration of calls to and from your device, select **Call duration**.

To view the amount of data transferred during packet data connections, select **Packet data**.

### Video calls

#### Make a video call



**Warning:** Do not hold the device near your ear when the loudspeaker is in use, because the volume may be extremely loud.

To make a video call, enter the phone number or select the recipient from the contacts list and **Options > Call > Video call**. When the video call starts, the camera of the device is activated. If the camera is already in use, video sending is disabled. If the recipient of the call does not want to send video back to you, a still image is shown instead. To define the still image sent from your device instead of video, select  > **Settings > Settings** and **Phone > Call > Image in video call**.

To disable the sending of audio, video, or video and audio, select **Options > Disable > Sending audio, Sending video, or Sending aud. & video**.

To adjust the volume of an active video call, use the volume keys.

## Call functions

To use the loudspeaker, select **Options > Activate loudspeaker**. To mute the loudspeaker and use the earpiece, select **Options > Activate handset**.

To swap the places of images, select **Options > Swap images**.

To zoom the image on the display, select **Options > Zoom** and scroll up or down.

To end the video call and make a new voice call to the same recipient, select **Options > Switch to voice call**.

### Answer or reject a video call

When a video call arrives,  is displayed.

1. To answer the video call, press the call key.
2. To start sending live video image, select **Yes**.

If you do not activate the video call, you only hear the voice of the caller. A grey screen replaces the video image. To replace the grey screen with a still image captured by the camera in your device, select  > **Settings** and **Telephony > Call > Image in video call**.

## Call settings

### Call settings

Select  > **Settings > Settings and Phone > Call**.

Select from the following:

- **Send my caller ID** — Display your phone number to the person you are calling.

- **Call waiting** — Set the device to notify you of incoming calls while you are in a call (network service).
- **Reject call with message** — Reject a call, and send a text message to the caller.
- **Message text** — Write the standard text message that is sent when you reject a call.
- **Own video in recvd. call** — Allow or deny video sending during a video call from your device.
- **Image in video call** — Display a still image if video is not sent during a video call.
- **Automatic redial** — Set your device to make a maximum of 10 attempts to connect the call after an unsuccessful call attempt. To stop automatic redialling, press the end key.
- **Show call duration** — Display the length of a call during the call.
- **Summary after call** — Display the length of a call after the call.
- **Speed dialling** — Activate speed dialling.
- **Anykey answer** — Activate anykey answer.
- **Line in use** — This setting (network service) is shown only if the SIM card supports two subscriber numbers, that is, two phone lines. Select which phone line you want to use for making calls and sending text messages. Calls on both lines can be answered irrespective of the selected line. If you select **Line 2** and have not subscribed to this network service, you are not able to make calls. When line 2 is selected, **2** is displayed in the home screen.
- **Line change** — Prevent line selection (network service), if supported by your SIM card. To change this setting, you need the PIN2 code.

## Call functions

### Call divert

Select  > **Settings** > **Settings and Phone** > **Call divert**.

Divert incoming calls to your voice mailbox or to another phone number. For details, contact your service provider.

Select the type of calls to divert and from the following options:

- **If busy** — Divert incoming calls if you have an active call.
- **If not answered** — Divert incoming calls after your device rings for a specified length of time. Select the length of time for the device to ring before diverting the call.
- **If out of reach** — Divert calls when the device is switched off or out of network coverage.
- **If not available** — Divert calls if you have an active call, do not answer, or the device is switched off or out of network coverage.

To divert calls to your voice mailbox, select a call type, a diverting option, and **Options** > **Activate** > **To voice mailbox**.

To divert calls to another phone number, select a call type, a diverting option, and **Options** > **Activate** > **To other number**. Enter the number, or select **Find** to retrieve a number saved in Contacts.

To check the current diverting status, scroll to the diverting option, and select **Options** > **Check status**.

To stop diverting calls, scroll to the diverting option, and select **Options** > **Deactivate**.

### Call barring

Select  > **Settings** > **Settings and Phone** > **Call barring**.

You can bar the calls that can be made or received with the device (network service). To change the settings, you need the barring password from your service provider. Call barring affects all call types.

Call barring and call diverting cannot be active at the same time.

When calls are barred, calls may be possible to certain official emergency numbers.

To bar calls, select from the following:

- **Outgoing calls** — Prevent making voice calls with your device.
- **Incoming calls** — Prevent incoming calls.
- **International calls** — Prevent calling to foreign countries or regions.
- **Incoming calls when roaming** — Prevent incoming calls when outside your home country.
- **International calls except to home country** — Prevent calls to foreign countries or regions, but allow calls to your home country.

To check the status of voice call barrings, select the barring option and **Options** > **Check status**.

To deactivate all voice call barrings, select a barring option and **Options** > **Deactivate all barrings**.



## Call functions

### Network settings

Select  > **Settings** > **Settings and Phone** > **Network**.

To select the network mode, select **Network mode** and **Dual mode**, **UMTS**, or **GSM**. In dual mode, the device switches automatically between networks.

 **Tip:** Selecting **UMTS** enables faster data transfer, but may increase the demand on battery power and reduce the battery life. In regions close to both GSM and UMTS networks, selecting **Dual mode** may cause constant jumping between the two networks, which also increases the demand on battery power.

To select the operator, select **Operator selection** and **Manual** to select from available networks, or **Automatic** to set the device to select the network automatically.

To set the device to indicate when it is used in a microcellular network (MCN), select **Cell info display** > **On**.

### Video sharing

#### Video sharing requirements

Video sharing requires a UMTS connection. For more information on the service, UMTS network availability, and fees associated with using this service, contact your service provider.

To use video sharing you must do the following:

- Ensure that your device is set up for person-to-person connections.

- Ensure you have an active UMTS connection and are within UMTS network coverage. If you move outside the UMTS network during a video sharing session, the sharing stops while your voice call continues.
- Ensure that both the sender and recipient are registered to the UMTS network. If you invite someone to a sharing session and the recipient's device is not within UMTS network coverage, does not have video sharing installed, or person-to-person connections set up, the recipient does not receive invitations. You receive an error message that indicates that the recipient cannot accept the invitation.

#### Share live video or video clips

During an active voice call, select **Options** > **Share video**.

1. To share live video during the call, select **Live video**.

To share a video clip, select **Video clip** and the clip you want to share.









You may need to convert the video clip into a suitable format to be able to share it. If your device notifies you that the video clip must be converted, select **OK**. Your device must have a video editor for the conversion to work.

2. If the recipient has several SIP addresses or phone numbers including the country code saved in the contacts list, select the desired address or number. If the SIP address or phone number of the recipient is not available, enter the address or number of the recipient including the country code, and select **OK** to send the invitation. Your device sends the invitation to the SIP address.

## Music

Sharing begins automatically when the recipient accepts the invitation.

### Options during video sharing

-  Zoom the video (available for sender only).
-  Adjust the brightness (available for sender only).
-  or  Mute or unmute the microphone.
-  or  Turn the loudspeaker on and off.
-  or  Pause and resume video sharing.
-  Switch to full screen mode (available for receiver only).

## 5. Music

 **Warning:** Listen to music at a moderate level. Continuous exposure to high volume may damage your hearing. Do not hold the device near your ear when the loudspeaker is in use, because the volume may be extremely loud.

You can listen to music also when the offline profile is activated. See "Offline profile", p. 14.

### Music player

#### Play a song

Select  > **Applications** > **Music player**.

3. To end the sharing session, select **Stop**. To end the voice call, press the end key. When you end the call, video sharing also ends.

To save the live video you shared, select **Yes** when prompted. The device notifies you of the location of the saved video.

If you access other applications while you are sharing a video clip, the sharing is paused. To return to the video sharing view, and to continue sharing, in the home screen, select **Options** > **Continue**.

To add all available songs to the music library, select **Options** > **Refresh library**.

To play a song, select the desired category, and the song.

To pause playback, press the scroll key; to resume, press the scroll key again. To stop playback, scroll down.

To fast-forward or rewind, press and hold the scroll key to the right or left.

To skip to the next item, scroll right. To return to the beginning of the item, scroll left. To skip to the previous item, scroll left again within 2 seconds after a song or podcast has started.

**Music**

To modify the tone of the music playback, select **Options** > **Equaliser**.

To modify the balance and stereo image, or to enhance the bass, select **Options** > **Audio settings**.

To view a visualisation during playback, select **Options** > **Show visualisation**.

To return to the home screen and leave the player playing in the background, press the end key briefly.

 **Warning:** Listen to music at a moderate level. Continuous exposure to high volume may damage your hearing.

**Say and Play**

With Say and Play, you can start playing the music you wish by saying, for example, the artist's name.

To start the Say and Play application, select  > **Applications** > **Music search**. When the tone sounds, say an artist's name, artist's name and song title, album title, or playlist title. Hold the device about 20 cm (8 inches) from your mouth, and speak in a regular tone. Do not cover the device microphone with your hand.

When you use Say and Play for the first time, and after you have downloaded new songs to your device, to update voice commands, select **Options** > **Refresh**.

The voice commands are based on the metadata (artist's name and song title) of the songs in your device. Say and Play supports two spoken languages: English and the language

you have chosen as the device language. The written language of the song metadata must match either English or your chosen device language.



**Tip:** To improve search accuracy, use the voice commands for dialling. The dialler adapts to your voice and uses it also for music search.

**Transfer music from PC**

1. Ensure that a compatible memory card is inserted in the device.
2. Connect your device to the PC using Bluetooth connectivity or a compatible USB data cable.
3. If you are using a USB data cable, select **Media transfer** as the connection mode.

If you select **Media transfer** as the connection mode, you can use Windows Media Player to synchronise music between your device and PC.

**FM Radio****Listen to the radio**

Select  > **Applications** > **Radio**.

The FM radio depends on an antenna other than the wireless device antenna. A compatible headset or accessory needs to be attached to the device for the FM radio to function properly.



## Positioning

 **Warning:** Listen to music at a moderate level. Continuous exposure to high volume may damage your hearing. Do not hold the device near your ear when the loudspeaker is in use, because the volume may be extremely loud.

The quality of the radio broadcast depends on the coverage of the radio station in that particular area.

You can make a call or answer an incoming call while listening to the radio. The radio is muted when there is an active call.

To start a station search, select  or .

If you have saved radio stations in your device, to go to the next or previous saved station, select  or .

Select **Options** and from the following:

- **Activate loudspeaker** — Listen to the radio using the loudspeaker.
- **Manual tuning** — Change the frequency manually.
- **Station directory** — View available stations based on location (network service).
- **Save station** — Save the station to which you are currently tuned to your station list.
- **Stations** — Open the list of your saved stations.
- **Play in background** — Return to the home screen while listening to the FM radio in the background.

## 6. Positioning

### About GPS

The coordinates in the GPS are expressed in the degrees and decimal degrees format using the international WGS-84 coordinate system.

Different positioning methods can be enabled or disabled in positioning settings.

### Assisted GPS (A-GPS)

Your device also supports assisted GPS (A-GPS).

A-GPS is a network service.

When you activate A-GPS, your device receives useful satellite information from an assistance data server over the cellular network. With the help of assisted data, your device can obtain the GPS position faster.

Your device is preconfigured to use the Nokia A-GPS service, if no service provider-specific A-GPS settings are available. The assistance data is retrieved from the Nokia A-GPS service server only when needed.

To disable the A-GPS service, select  > **Applications** > **GPS data** and **Options** > **Positioning settings** > **Positioning methods** > **Assisted GPS** > **Disable**.

You must have an internet access point defined in the device to retrieve assistance data from the Nokia A-GPS service over a packet data connection. The access point for A-GPS can be defined in positioning settings. Only a packet data internet access point can be used. Your device asks you to select the internet access point when GPS is used for the first time.

## Maps

Select  > **Maps**.

### About Maps

With Maps, you can see your current location on the map, browse maps of different cities and countries, search for places, plan routes from one location to another, save locations, and send them to compatible devices. You can also purchase licences for traffic information and navigation services, if available for your country or region.

When you use Maps for the first time, you may need to select an internet access point for downloading maps.

If you browse to an area which is not covered by maps already downloaded in your device, a map for the area is automatically downloaded through the internet. Some maps may be available in your device or on a memory card. You can also use the Nokia Map Loader PC software to download maps. To install Nokia Map Loader to a compatible PC, see [www.nokia.com/maps](http://www.nokia.com/maps).



**Tip:** To avoid data transfer costs, you can also use Maps without an internet connection, and browse the maps that are saved in your device or memory card.



**Note:** Downloading maps may involve the transmission of large amounts of data through your service provider's network. Contact your service provider for information about data transmission charges.

Almost all digital cartography is inaccurate and incomplete to some extent. Never rely solely on the cartography that you download for use in this device.

For instructions on how to use the various features of Maps, select  > **Applications** > **Help** > **Help and Maps**, or when using Maps, select **Options** > **Help**.

### Move on a map

When the GPS connection is active,  shows your current location on the map.

To zoom in to your current or last known location, select **Options** > **My position**.

To move on the map, scroll up, down, left, or right with the scroll key. The map is oriented towards north by default.

When you have an active GPS connection and browse the map on the display, a new map is automatically downloaded if you scroll to an area not covered by the maps that have already been downloaded. The maps are automatically saved in the device memory or on a compatible memory card, if inserted.

To change the map type, select **Options** > **Map mode**.

## Positioning

### Display indicators

The GPS indicator  shows the availability of the satellite signals. One bar is one satellite. When the device tries to find satellite signals, the bar is yellow. When the device receives enough data from the satellites for GPS to calculate your location, the bar turns green. The more green bars, the more reliable the location calculation.

Initially, your device must receive signals from at least four satellites to calculate the coordinates of your location. After the initial calculation, signals from three satellites may be enough.

The data transfer indicator  shows the internet connection used, and the amount of data transferred since the application started.

### Landmarks

Select  > **Applications** > **Landmarks**.

With Landmarks, you can save the position information of specific locations in your device. You can sort the saved locations into different categories, such as business, and add other information to them, such as addresses. You can use your saved landmarks in compatible applications, such as GPS data.

GPS coordinates are expressed in the degrees and decimal degrees format using the international WGS-84 coordinate system.

Select **Options** and from the following:

- **New landmark** — Create a new landmark. To make a positioning request for your current location, select **Current position**. To select the location from map, select **Select from map**. To enter the position information manually, select **Enter manually**.
- **Edit** — Edit or add information to a saved landmark (for example, a street address).
- **Add to category** — Add a landmark to a category in Landmarks. Select each category to which you want to add the landmark.
- **Send** — Send one or several landmarks to a compatible device. Your received landmarks are placed in the Inbox folder in Messaging.

You can sort your landmarks into preset categories, and create new categories. To edit and create new landmark categories, open the categories tab, and select **Options** > **Edit categories**.

### GPS data

#### Route guidance

Select  > **Applications** > **GPS data** and **Navigation**.

Start the route guidance outdoors. If started indoors, the GPS receiver may not receive the necessary information from the satellites.

Route guidance uses a rotating compass on the device display. A red ball shows the direction to the destination, and the approximate distance to it is shown inside the compass ring.

Write text

Route guidance is designed to show the straightest route and the shortest distance to the destination, measured in a straight line. Any obstacles on the route, such as buildings and natural obstacles, are ignored. Differences in altitude are not taken into account when calculating the distance. Route guidance is active only when you move.

To set your trip destination, select **Options > Set destination** and a landmark as the destination, or enter the latitude and longitude coordinates.

To clear the destination set for your trip, select **Stop navigation**.

### Retrieve position information

Select **Home > Applications > GPS data and Position**.

In the position view, you can view the position information of your current location. An estimate of the accuracy of the location is displayed.

To save your current location as a landmark, select **Options > Save position**. Landmarks are saved locations with more information, and they can be used in other compatible applications and transferred between compatible devices.

## 7. Write text

### Traditional text input

**Abc** is shown on the top right of the display when you are writing text using traditional text input.

### Trip meter

Select **Home > Applications > GPS data and Trip distance**.

To turn trip distance calculation on or off, select **Options > Start or Stop**. The calculated values remain on the display. Use this feature outdoors to receive a better GPS signal.

To set the trip distance and time and average and maximum speeds to zero, and to start a new calculation, select **Options > Reset**. To set the trip meter and total time to zero, select **Restart**.

### About Nokia Sports Tracker

Nokia Sports Tracker is a GPS-based workout tracker. You can monitor, analyse, and share your sports activities. The application automatically stores information such as speed, distance, and time to your training diary. You can visualise and replay your workouts, and analyse your progress. You can also share workouts over a mobile network, and compete against yourself or a friend.

**ABC** and **abc** indicate the selected case. **Abc** indicates that the first letter of the sentence is written in uppercase and all the other letters are automatically written in lowercase. **123** indicates the number mode.

**Write text**

To write text with the keypad, press a number key **2-9** repeatedly until the desired character appears. There are more characters available for a number key than are printed on the key. If the next letter is located on the same key as the present one, wait until the cursor appears, and enter the letter.

To insert a number, press and hold the number key.

To switch between the upper and lower case mode and the number mode, press **#**.

To erase a character, press the clear key. Press and hold the clear key to erase more than one character.

To erase a character, press the backspace key. Press and hold the backspace key to erase more than one character.

To access the most common punctuation marks, press the **1** key. Press **1** repeatedly to reach the desired punctuation mark.

To add special characters, press **\***. Scroll to the desired character and press the scroll key.

To insert a space, press **0**. To move the cursor to the next line, press **0** three times.

To switch between the different character cases, press **#**.

**Predictive text input**

1. To activate predictive text input, press **#** twice quickly. This activates predictive text input for all editors in the device. The indicator  is shown on the display.

2. To write the desired word, press **2-9**. Press each key only once for one letter.

3. When you have finished writing the word and it is correct, scroll right to confirm it, or press **0** to add a space.

If the word is not correct, press **\*** repeatedly to view the matching words the dictionary has found.

If the **?** character is shown after the word, the word you intended to write is not in the dictionary. To add a word to the dictionary, select **Spell**, enter the word (up to 32 letters) using traditional text input, and select **OK**. The word is added to the dictionary. When the dictionary is full, the new word replaces the oldest added word.

Write the first half of a compound word; to confirm it, scroll right. Write the last part of the compound word. To complete the compound word, press **0** to add a space.

To switch predictive text input off for all editors in the device, press **#** twice quickly.

**Change the writing language**

When you are writing text, you can change the writing language. For example, if you press the **6** key repeatedly to reach a specific character, changing the writing language gives you access to characters in a different order.

If you are writing text using a non-Latin alphabet and want to write Latin characters, for example e-mail or web addresses, you may need to change the writing language. To change the writing language, select **Options > Writing language**, and a writing language that uses Latin characters.



## Copy and delete text

1. To select letters and words, press and hold #, and at the same time scroll left or right. To select lines of text, press and hold #, and at the same time scroll up or down.
2. To copy the text, press and hold #, and at the same time select **Copy**.
3. To delete the selected text, press the clear key C. To paste the text, scroll to the desired location, press and hold #, and at the same time select **Paste**.

## 8. Messaging

Select  > **Messaging**.

In Messaging (network service), you can send and receive text, multimedia, audio, and e-mail messages. You can also receive web service messages, cell broadcast messages, and special messages containing data, and send service commands.

The available messaging types may vary. For more information, contact your service provider.

Before sending or receiving messages, you may need to do the following:

- Insert a valid SIM card in the device and be located in the service area of a cellular network.
- Verify that the network supports the messaging features you want to use and that they are activated on your SIM card.
- Define the internet access point settings on the device.
- Define the e-mail account settings on the device.
- Define the text message settings on the device.

- Define the multimedia message settings on the device. The device may recognise the SIM card provider and automatically configure some of the message settings. If not, you may need to define the settings manually; or contact your service provider to configure the settings.

The appearance of a picture message may vary depending on the receiving device.

Only devices that have compatible features can receive and display multimedia messages. The appearance of a message may vary depending on the receiving device.

## Write and send messages

Select  > **Messaging**.

 **Important:** Exercise caution when opening messages. Messages may contain malicious software or otherwise be harmful to your device or PC.

## Messaging

Before you can create a multimedia message or write an e-mail, you must have the correct connection settings in place. The wireless network may limit the size of MMS messages. If the inserted picture exceeds this limit the device may make it smaller so that it can be sent by MMS.

Check the size limit of e-mail messages with your service provider. If you attempt to send an e-mail message that exceeds the size limit of the e-mail server, the message is left in the Outbox folder, and the device attempts to resend it periodically. Sending an e-mail requires a data connection, and continuous attempts to resend the e-mail may increase your phone bill. In the Outbox folder, you can delete such a message, or move it to the Drafts folder.

1. Select **New message** > **Message** to send a text or multimedia message (MMS), **Audio message** to send a multimedia message that includes one sound clip, or **E-mail** to send an e-mail message.
2. In the To field, press the scroll key to select recipients or groups from the contacts list, or enter the recipient's phone number or e-mail address. To add a semicolon (;) that separates the recipients, press \*. You can also copy and paste the number or address from the clipboard.
3. In the subject field, enter the subject of the e-mail. To change the fields that are visible, select **Options** > **Message header fields**.
4. In the message field, write the message. To insert a template or note, select **Options** > **Insert content** > **Insert text** > **Template** or **Note**.

5. To add a media file to a multimedia message, select **Options** > **Insert content**, the file type or source, and the desired file. To insert a business card, slide, note, or some other file to the message, select **Options** > **Insert content** > **Insert other**.
6. To capture an image or record a video or sound clip for a multimedia message, select **Options** > **Insert content** > **Insert image** > **New**, **Insert video clip** > **New**, or **Insert sound clip** > **New**.
7. To add an attachment to an e-mail, select **Options** and the attachment type. E-mail attachments are indicated by .
8. To send the message, select **Options** > **Send**, or press the call key.

 **Note:** The message sent icon or text on your device screen does not indicate that the message is received at the intended destination.

Your device supports text messages beyond the limit for a single message. Longer messages are sent as two or more messages. Your service provider may charge accordingly. Characters with accents or other marks, and characters from some language options, take up more space, and limit the number of characters that can be sent in a single message.

You may not be able to send video clips that are saved in the MP4 file format or that exceed the size limit of the wireless network in a multimedia message.

## E-mail

### Set up your e-mail

With the Nokia e-mail wizard, you can set up your corporate e-mail account, such as Microsoft Outlook, Mail for Exchange, or Intellisync, and your internet e-mail account.

When setting up your corporate e-mail, you may be prompted for the name of the server associated with your e-mail address. Ask your company IT department for details.

1. To start the wizard, go to the home screen, scroll to the e-mail wizard, and press the scroll key.
2. Enter your e-mail address and password. If the wizard is not able to configure your e-mail settings automatically, you need to select your e-mail account type and enter the related account settings.

If your device contains any additional e-mail clients, those are offered to you when you start the e-mail wizard.

### Send e-mail

Select  > **Messaging**.

1. Select your mailbox and **Options > Create email**.
2. In the To field, enter the recipient's e-mail address. If the recipient's e-mail address can be found in Contacts, start entering the recipient's name, and select the recipient from the proposed matches. If you add several recipients, insert ; to separate the e-mail addresses. Use the Cc field to send a copy to other recipients, or the Bcc field to send a blind copy to recipients. If the Bcc field is not visible, select **Options > More > Show Bcc field**.

3. In the Subject field, enter the subject of the e-mail.
4. Enter your message in the text area.
5. Select **Options** and from the following:
  - **Add attachment** — Add an attachment to the message.
  - **Priority** — Set the priority of the message.
  - **Flag** — Flag the message for follow-up.
  - **Insert template** — Insert text from a template.
  - **Add recipient** — Add recipients to the message from Contacts.
  - **Editing options** — Cut, copy, or paste the selected text.
  - **Writing language:** — Select the writing language.
6. Select **Options > Send**.

### Add attachments

Select  > **Messaging**.

To write an e-mail message, select your mailbox and **Options > Create email**.

To add an attachment to the e-mail message, select **Options > Add attachment**.

To remove the selected attachment, select **Options > Remove attachment**.

### Read e-mail

Select  > **Messaging**.

## Messaging



**Important:** Exercise caution when opening messages. Messages may contain malicious software or otherwise be harmful to your device or PC.

To read a received e-mail message, select the mailbox, and select the message from the list.

To reply to the message sender, select **Options** > **Reply**. To reply to the sender and all other recipients, select **Options** > **Reply to all**.

To forward the message, select **Options** > **Forward**.

### Download attachments

Select  > **Messaging** and a mailbox.

To view the attachments in a received e-mail message, scroll to the attachment field, and select **Options** > **Actions** > **Open**. If there are several attachments in the message, a list opens showing which attachments have been downloaded or not.

To download the selected attachment or all the attachments from the list to your device, select **Options** > **Download** or **Download all**. The attachments are not saved in your device, and are deleted when you delete the message.

To save the selected attachment or all the downloaded attachments in your device, select **Options** > **Save** or **Save all**.

To open the selected, downloaded attachment, select **Options** > **Actions** > **Open**.

### Reply to a meeting request

Select  > **Messaging** and a mailbox.

Select a received meeting request, **Options**, and from the following:

- **Accept** — Accept the meeting request.
- **Decline** — Decline the meeting request.
- **Forward** — Forward the meeting request to another recipient.
- **Remove from calendar** — Remove a cancelled meeting from your calendar.

### Search for e-mail messages

Select  > **Messaging** and a mailbox.

To search for items within the recipients, subjects, and body texts of the e-mail messages in the mailbox, select **Options** > **Search**.

To stop the search, select **Options** > **Stop search**.

To start a new search, select **Options** > **New search**.

### Delete e-mails

Select  > **Messaging** and a mailbox.

To delete the selected e-mail message, select **Options** > **Delete**. The message is placed in the Deleted items folder, if available.

To empty the Deleted items folder, select the folder and **Options** > **Empty deleted items**.

### Switch between e-mail folders

Select  > **Messaging** and a mailbox.

To open another e-mail folder or mailbox, select **Inbox** at the top of the display. Select the e-mail folder or mailbox from the list.

### Disconnect from the mailbox

Select  > **Messaging** and a mailbox.

To cancel the synchronisation between the device and the e-mail server, and to work with e-mail without a wireless connection, select **Options** > **Disconnect**. If your mailbox does not have the **Disconnect** option, select **Options** > **Exit** to disconnect from the mailbox.

To start the synchronisation again, select **Options** > **Connect**.

### Set on an out-of-office reply

Select  > **Messaging**.

To set on an out-of-office reply, select your mailbox and, depending on your mailbox type, either **Options** >

**Settings** > **Mailbox settings** > **Out of office** > **On** or **Options** > **Settings** > **Intellisync** > **Mailbox settings** > **Out of office** > **On**.

To enter the text for the reply, select **Out of office reply**.

### General e-mail settings

Select  > **Messaging**, mailbox, and **Options** > **Settings** > **Global settings** and from the following:

- **Message list layout** — Select whether the e-mail messages in Inbox display one or two lines of text.
- **Body text preview** — Select whether to preview messages when scrolling through the list of e-mail messages in Inbox.
- **Title dividers** — Select **On** to be able to expand and collapse the list of e-mail messages.
- **Download notifications** — Select whether to have the device to display a notification when an e-mail attachment has been downloaded.
- **Home screen** — Define how many lines of e-mail are shown in the home screen information area.

## 9. Contacts

Select  > **Contacts**.

In Contacts, you can save and update contact information, such as phone numbers, home addresses, or e-mail addresses of your contacts. You can add a personal ringing tone or a thumbnail image to a contact card. You can also create

contact groups, which allow you to send text messages or e-mail to many recipients at the same time.

For more information on Contacts and SIM contacts, see the extended user guide on the product support pages of the Nokia website.

## Gallery

### Manage names and numbers

To send contact information, select a card, **Options** > **Send**, and the desired option.

To listen to the voice tag assigned to the contact, select a contact card and **Options** > **Voice tag details** > **Play voice tag**.

### Save and edit names and numbers

1. To add a new contact to the contacts list, select **Options** > **New contact**.

2. Fill in the fields that you want, and select **Done**.

To edit contacts, select a contact and **Options** > **Edit**.

### Ringing tones, images, and call text for contacts

You can define a ringing tone for a contact or group, and an image and a call text for a contact. When the contact calls you, the device plays the selected ringing tone and shows the call text or image (if the caller's phone number is sent with the call and your device recognises it).

To define a ringing tone for a contact or a contact group, select the contact or contact group and **Options** > **Ringing tone**, and a ringing tone.

## 10. Gallery

Select  > **Gallery**.

To define a call text for a contact, select the contact and **Options** > **Add text for call**. Enter the call text, and select **OK**.

To add an image for a contact saved in the device memory, select the contact, **Options** > **Add image**, and an image from Gallery.

To remove the ringing tone, select **Default tone** from the list of ringing tones.

To view, change or remove the image from a contact, select the contact, **Options** > **Image**, and the desired option.

### Copy contacts

When you open the contacts list for the first time, the device asks if you want to copy names and numbers from the SIM card to your device.

To start copying, select **OK**.

If you do not want to copy the contacts from the SIM card to your device, select **Cancel**. The device asks if you want to view the SIM card contacts in the contacts directory. To view the contacts, select **OK**. The contacts list opens, and the names stored on your SIM card are indicated with .

**Camera**

Use Gallery to access different types of media, such as images and videos, music, sound clips, streaming links and presentations. All viewed images and videos, and music and sound clips are automatically saved to Gallery. Sound clips and music are played in the Music player, streaming links by the Video centre. Images are viewed and videos are played with the Photos application.

**About Photos**

Select  > **Gallery** > **Images & videos** and from the following:

- **Captured** — View all the images and videos you have captured.
- **Months** — View images and videos categorised by the month they were captured.

**11. Camera****Capture an image**

To activate the camera, press and hold the capture key. When the camera is activated, the screen is automatically rotated to landscape mode.

To capture an image, use the display as a viewfinder, and press the capture key. The device saves the image in Gallery.







To zoom in or out before capturing an image, use the volume keys.

- **Albums** — View the default albums and the ones you have created.
- **Tags** — View the tags you have created for each item.
- **Downloads** — View items and videos downloaded from the web or received as a multimedia or e-mail message.
- **All** — View all items.
- **Share online** — Post images or videos to the web.



Files stored on your compatible memory card (if inserted) are indicated with .

To copy or move files to another memory location, select a file, **Options** > **Move and copy**, and from the available options.

The toolbar provides you with shortcuts to different items and settings before and after capturing an image or recording a video clip. Select from the following:

-  Switch between video and image mode.
-  Select the scene.
-  Turn the video light on (video mode only).
-  Select the flash mode (images only).
-  Activate the self-timer (images only).
-  Activate sequence mode (images only).

## Internet

-  Select a colour effect.
-  Adjust the white balance.
-  Go to Gallery.

The available options vary depending on the capture mode and view you are in. The settings return to the default values when you close the camera.

To customise the camera toolbar, select **Options** > **Customise toolbar**.

To activate the toolbar when it is hidden, press the scroll key.

Keep a safe distance when using the flash. Do not use the flash on people or animals at close range. Do not cover the flash while taking a picture.

## 12. Internet

With your device, you can browse both the internet and your company's intranet, and download and install new applications to your device. You can also use your device as a modem and connect your PC to the internet.

### Web browser

With the Web browser application, you can view hypertext markup language (HTML) web pages on the internet as originally designed. You can also browse web pages that are designed specifically for mobile devices, and use extensible hypertext markup language (XHTML), or the wireless markup language (WML).

## Record videos

1. If the camera is in the image mode, select the video mode from the toolbar.
2. To start recording, press the capture key.
3. To pause recording at any time, select **Pause**. Select **Continue** to resume recording.
4. To stop recording, select **Stop**. The video clip is automatically saved in Gallery. The maximum length of the video clip depends on the available memory.

To browse the web, you need to have an internet access point configured in your device.

### Browse the web

Select  > **Web**.

 **Shortcut:** To start the browser, press and hold **0** in the home screen.

To browse the web, in the bookmarks view, select a bookmark, or start to enter a web address (the  field opens automatically), and select **Go to**.



Some web pages may contain material, such as graphics and sounds, that requires a large amount of memory to view. If your device runs out of memory while loading such a web page, the graphics on the page are not shown.

To browse web pages with graphics disabled, to save memory and increase the page loading speed, select **Options > Settings > Page > Load content > Text only**.

To enter a web address, select **Options > Go to > New web page**.

 **Tip:** While browsing, to visit a web page saved as a bookmark in the bookmarks view, press **1**, and select a bookmark.

To refresh the content of the web page, select **Options > Web page options > Reload**.

To save the current web page as a bookmark, select **Options > Web page options > Save as bookmark**.

To view snapshots of the web pages you have visited during the current browsing session, select **Back** (available if **History list** is activated in the browser settings and the current web page is not the first web page you visit).

To prevent or allow the automatic opening of multiple windows, select **Options > Web page options > Block pop-ups** or **Allow pop-ups**.

To view the shortcut key map, select **Options > Keypad shortcuts**. To edit the shortcut keys, select **Edit**.



**Tip:** To minimise the browser without exiting the application or connection, press the end key once. To end the connection, press and hold the end key.

## Web feeds and blogs

Select  > **Web**.

Web feeds are XML files on web pages that are used to share, for example, the latest news headlines or blogs. It is common to find web feeds on web, blog, and wiki pages.

The browser application automatically detects if a web page contains web feeds.

If web feeds are available, to subscribe to a web feed, select **Options > Subscribe to web feeds**.

To update a web feed, in the Web feeds view, select a feed and **Options > Web feed options > Refresh**.

To define whether the web feeds are updated automatically, in the Web feeds view, select **Options > Edit > Edit**. This option is not available if one or more feeds are marked.

## Empty the cache

The information or services you have accessed are stored in the cache memory of the device.

A cache is a memory location that is used to store data temporarily. If you have tried to access or have accessed confidential information requiring passwords, empty the cache after each use.

To empty the cache, select **Options > Clear privacy data > Cache**.

## Internet

### End the connection

To end the connection and close the browser, select **Options > Exit**.

To delete the information the network server collects about your visits to various web pages, select **Options > Clear privacy data > Cookies**.

### Connection security

If the security indicator (🔒) is displayed during a connection, the data transmission between the device and the internet gateway or server is encrypted.

The security icon does not indicate that the data transmission between the gateway and the content server (or the place where the requested resource is stored) is secure. The service provider secures the data transmission between the gateway and the content server.

Security certificates may be required for some services, such as banking services. You are notified if the identity of the server is not authentic or if you do not have the correct security certificate in your device. For more information, contact your service provider.

 **Important:** Even if the use of certificates makes the risks involved in remote connections and software installation considerably smaller, they must be used correctly in order to benefit from increased security. The existence of a certificate does not offer any protection by itself; the certificate manager must contain correct, authentic, or trusted certificates for increased security to be available.

Certificates have a restricted lifetime. If "Expired certificate" or "Certificate not valid yet" is shown, even if the certificate should be valid, check that the current date and time in your device are correct.

Before changing any certificate settings, you must make sure that you really trust the owner of the certificate and that the certificate really belongs to the listed owner.

### Connect PC to web

You can use your device to connect your PC to the web.

1. Connect the data cable to the USB connectors of your device and your PC.
2. Select **Connect PC to web**. The necessary software is automatically installed from your device to the PC.
3. Accept the installation in your PC. Accept also the connection, if prompted. When the connection to the web is established, the web browser of your PC opens.

You must have administrator rights to your PC, and the autorun option enabled in the PC.

### About Contacts on Ovi

With Contacts on Ovi, you can stay connected to the people who matter most. Search for contacts, and discover friends in the Ovi community. Keep in touch with your friends - chat, share your location and presence, and easily follow what your friends are up to and where they are. You can even chat with friends who use Google Talk™. Sync your contacts, calendar, and other content between your Nokia device and Ovi.com.

Your important information is stored and kept up-to-date both in your device and on the web. With Contacts on Ovi, you can make your contacts list dynamic and be confident that your contacts are stored on Ovi.com.

You must have a Nokia Account to use the service. Create an account on your mobile device, or go to [www.ovi.com](http://www.ovi.com) on your PC.

## Ovi Files

With Ovi Files, you can use your device to access content on your computer if it is switched on and connected to the internet. You will need to install the Ovi Files application to every computer you want to access with Ovi Files.

With Ovi Files, you can do the following:

- Browse, search, and view your images. You do not need to upload the images to the website; you can access your computer content with your mobile device.
- Browse, search, and view your files and documents. You do not need any special applications on your device.
- Download songs from your computer to your device. Later, you can use the music player on your device to listen to the songs as you normally would.
- Send files and folders from your computer without moving them to and from your device first.
- Access files on your computer even when your computer is switched off. Select which folders and files you want to be available, and Ovi Files automatically keeps an up-to-date copy stored in protected, online storage.

## To install Ovi Files:

1. Select  > **Applications** and **Ovi Files**.
2. Read the information, and select **Continue**.
3. Select the Email field, and enter your e-mail address.
4. Select **Done**.
5. Select **Send**. The Ovi Files service sends you an e-mail with information to get you started.

For support, see <http://files.ovi.com/support>.

## Nokia Music Store

Select  > **Applications** > **Music store**.

In the Nokia Music Store (network service) you can search, browse, and purchase music to download to your device. To purchase music, you first need to register for the service.

To access the Nokia Music Store, you must have a valid internet access point defined in the device.

Nokia Music Store is not available for all countries or regions.

To find more music in the different categories, select **Options** > **Find in Music store**.

To select the access point to use with the Nokia Music Store, select **Default access point**.

## Share online

### About Share online

Select  > **Applications** > **Share online**.

## Internet

With Share online, you can post images, video clips, and sound clips from your device to compatible online sharing services, such as albums and blogs. You can also view and send comments to the posts in these services, and download content to your compatible Nokia device.

The supported content types and the availability of the Share online service may vary.

### Subscribe to services

Select  > **Applications** > **Share online**.

To subscribe to an online sharing service, go to the service provider's website, and check that your Nokia device is compatible with the service. Create an account as instructed on the website. You receive a user name and password needed to set up your device with the account.

1. To activate a service, open the Share online application in your device, select a service and **Options** > **Activate**.
2. Allow the device to create a network connection. If you are prompted for an internet access point, select one from the list.
3. Sign in to your account as instructed on the service provider's website.

Nokia's services in the online sharing service are free of charge. Any data transferred over the network may incur charges from your service provider. For the availability and cost of the third party services and data transfer costs, contact your service provider or the relevant third party.

### Create a post

Select  > **Applications** > **Share online**.

To post multimedia files to a service, select a service and **Options** > **New post**. If the online sharing service provides channels for posting files, select the desired channel.

To add an image, video clip, or sound clip to the post, select **Options** > **Insert**.

To add a title or description to the post, enter text directly to the fields, if available.

To add tags to the post, select **Tags**.

To select whether to enable the posting of location information contained in the file, select **Location**.

To set the level of privacy for a file, select **Privacy**. To allow everyone to view your file, select **Public**. To restrict others from seeing your files, select **Private**. You can define the **Default** setting on the service provider's website.

To send the post to the service, select **Options** > **Upload**.

### Nokia Video Centre

With Nokia Video Centre (network service), you can download and stream video clips over the air from compatible internet video services using a packet data connection. You can transfer video clips from a compatible PC to your device and view them in Video centre.

Using packet data access points to download videos may involve the transmission of large amounts of data through

**Internet**

your service provider's network. Contact your service provider for information about data transmission charges. Your device may have predefined services. Service providers may provide free content or charge a fee. Check the pricing in the service or from the service provider.

**View and download video clips****Connect to video services**

1. Select  > **Applications** > **Video centre**.
2. To connect to a service to install video services, select **Video directory** and the desired video service from the service catalogue.



**Tip:** You can access the video services on the TV & video tab in the multimedia menu.

**View a video clip**

To browse the content of installed video services, select **Video feeds**.

The content of some video services is divided into categories. To browse video clips, select a category.

To search for a video clip in the service, select **Video search**. Search may not be available in all services.

Some video clips can be streamed over the air, but others must be first downloaded to your device. To download a video clip, select **Options** > **Download**. Downloads continue in the background if you exit the application. The downloaded video clips are saved in My videos.

To stream a video clip or view a downloaded one, select **Options** > **Play**. When the video clip is playing, use the selection keys and the scroll key to control the player. To adjust the volume, use the volume key.



**Warning:** Listen to music at a moderate level. Continuous exposure to high volume may damage your hearing.

Select **Options** and from the following:

- **Resume download** — Resume a paused or failed download.
- **Cancel download** — Cancel a download.
- **Preview** — Preview a video clip.
- **Feed details** — View information about a video clip.
- **Refresh list** — Refresh the list of video clips.
- **Open link in browser** — Open a link in the web browser.

**Schedule downloads**

Setting the application to download video clips automatically may involve the transmission of large amounts of data through your service provider's network. For information about data transmission charges, contact your service provider. To schedule an automatic download for video clips in a service, select **Options** > **Schedule downloads**. Video centre automatically downloads new video clips daily at the time you define.

To cancel scheduled downloads, select **Manual download** as the download method.

## Personalisation

### Search

Select  > **Search**.

Search enables you to use various internet-based search services to find and connect to, for example, local services,

websites, and images. The content and availability of the services may vary.

## 13. Personalisation

### Themes

#### Change the display theme

Select  > **Settings** > **Themes**.

To change the theme used in all applications, select **General**.

To change the theme used in the main menu, select **Menu view**.

To change the theme used in the home screen, select **Standby theme**.

To change the background image of the home screen, select **Wallpaper**.

To select an animation for the screen saver, select **Power saver**.

To turn theme effects on or off, select **General** > **Options** > **Theme effects**.

#### Download a theme

To download a theme, select **General** or **Menu view** > **Download themes**. Enter the link from which you want to

download your theme. Once the theme is downloaded, you can preview, activate, or edit it.

To preview a theme, select **Options** > **Preview**.

To start using the selected theme, select **Options** > **Set**.

### Profiles

Select  > **Settings** > **Profiles**.

You can adjust and customise the ringing tones, alert tones, and other device tones for different events, environments, or caller groups. The active profile is shown at the top of the display in the home screen. However, if the active profile is General, only today's date is shown.

To create a new profile, select **Options** > **Create new**, and define the settings.

To customise a profile, select a profile and **Options** > **Personalise**.

To change a profile, select a profile and **Options** > **Activate**. The Offline profile prevents your device from accidentally switching on, sending or receiving messages, or using Bluetooth connectivity, GPS, or FM radio; it also closes

**Time management**

any internet connection that may be in operation when the profile is selected. The Offline profile does not prevent you from establishing a Bluetooth connection at a later time, or from restarting the GPS or FM radio, so comply with any applicable safety requirements when establishing and using these features.

To set the profile to be active until a certain time within the next 24 hours, scroll to the profile, select **Options** >

**Timed**, and set the time. When the time expires, the profile changes back to the previously active non-timed profile. When the profile is timed, ⌚ is displayed in the home screen. The Offline profile cannot be timed.

To delete a profile that you created, select **Options** > **Delete profile**. You cannot delete the predefined profiles.

## 14. Time management

### Calendar

Select  > **Calendar**.

#### Create a calendar entry

- To add a new calendar entry, scroll to the desired date, select **Options** > **New entry** and from the following:
  - **Meeting** — Add a reminder of your meeting.
  - **Meeting request** — Create and send a new meeting request. You must have a mailbox set up for sending requests.
  - **Memo** — Write a general note for the day.
  - **Anniversary** — Add a reminder of birthdays or special dates (entries are repeated annually).
  - **To-do** — Add a reminder of a task that must be done by a specific date.
- To add a description to an entry, select **Options** > **Add description**.

- To save the entry, select **Done**.



**Tip:** In the day, week, or month calendar view, press a key (0-9). An appointment entry opens, and the characters you enter are added to the subject field. In the to-do view, a to-do note entry opens.

When the calendar alarm sounds, select **Silence** to mute the alarm.

To stop the calendar alarm, select **Stop**.

To set the alarm to snooze, select **Snooze**.

To define the period after which the calendar alarm sounds again when set to snooze, select **Options** > **Settings** > **Alarm snooze time**.

#### Calendar views

To switch between month, week, and to-do note view, select **Options** > **Month view**, **Week view**, or **To-do view**.

### Office applications

To change the starting day of the week, the view that is shown when you open the calendar, or the calendar alarm settings, select **Options** > **Settings**.

To go to a certain date, select **Options** > **Go to date**. To go to today, press #.

### Alarm clock

Select  > **Applications** > **Clock**.

To view your active and inactive alarms, open the alarms tab. To set a new alarm, select **Options** > **New alarm**. Define the repetition, if needed. When an alarm is active,  is displayed.

To turn off the sounding alarm, select **Stop**. To stop the alarm for a certain time period, select **Snooze**. If your device is switched off when an alarm is due, your device switches itself on and starts sounding the alarm tone.

 **Tip:** To define the time period after which the alarm sounds again when you set it to snooze, select **Options** > **Settings** > **Alarm snooze time**.

## 15. Office applications

### PDF reader

Select  > **Applications** > **Office** > **Adobe PDF**.

With PDF reader, you can read PDF documents on the display of your device; search for text in the documents; modify

To cancel an alarm, select **Options** > **Remove alarm**.

To change the time, date, and clock type settings, select **Options** > **Settings**.

### Clock settings

Select **Options** > **Settings**.

To change the time or date, select **Time** or **Date**.

To change the clock shown on the home screen, select **Clock type** > **Analogue** or **Digital**.

To allow the mobile phone network to update the time, date, and time zone information to your device (network service), select **Automatic time update** > **On**.

To change the alarm tone, select **Clock alarm tone**.

settings, such as zoom level and page views; and send PDF files using e-mail.

### Dictionary

Select  > **Applications** > **Office** > **Dictionary**.



To translate words from one language to another, enter text in the search field. As you enter text, suggestions of words to translate are displayed. To translate a word, select the word from the list.

Select **Options** and from the following:

- **Listen** — Listen to the selected word.
- **History** — Find previously translated words from the current session.
- **Languages** — Change the source or target language.
- **Languages** — Download languages from the internet or remove a language from the dictionary. You cannot remove the English language from the dictionary. You can have two additional languages installed, besides English.
- **Speech** — Edit the voice feature settings. You can adjust the speed and volume of the voice.

## About Quickoffice

Select  > **Applications** > **Office** > **Quickoffice**.

Quickoffice consists of Quickword for viewing Microsoft Word documents, Quicksheet for viewing Microsoft Excel worksheets, Quickpoint for Microsoft PowerPoint presentations, and Quickmanager for purchasing software. You can view Microsoft Office 2000, XP, and 2003 documents (DOC, XLS, and PPT file formats) with Quickoffice. If you have the editor version of Quickoffice, you can also edit files.

Not all file formats or features are supported.

## Converter

With Converter, you can convert measures from one unit to another.

The converter has limited accuracy, and rounding errors may occur.

## Currency converter

Select  > **Applications** > **Office** > **Converter**.

Select **Type** > **Currency**. Before you can make currency conversions, you must select a base currency and add exchange rates. The default base currency is Home. The rate of the base currency is always 1.

1. Select **Options** > **Currency rates**.
2. The default name for the currency items is Foreign. To rename a currency, select **Options** > **Rename currency**.
3. Add the exchange rates for the currencies, and select **Done**.
4. In the other Unit field, select the currency to which you want to convert.
5. In the first Amount field, enter the value you want to convert. The other Amount field shows the converted value automatically.

To change the base currency, select **Options** > **Currency rates**, a currency and **Options** > **Set as base currency**.

## Office applications

When you change base currency, you must enter new exchange rates because all previously set exchange rates are cleared.

### Convert measures

Select  > **Applications** > **Office** > **Converter**.

1. In the Type field, select the measure you want to use.
2. In the first Unit field, select the unit from which you want to convert.
3. In the other Unit field, select the unit to which you want to convert.
4. In the first Amount field, enter the value you want to convert.

The other Amount field shows the converted value automatically.

### Calculator

Select  > **Applications** > **Office** > **Calculator**.

This calculator has limited accuracy and is designed for simple calculations.

To make a calculation, enter the first number of the calculation. Select a function such as add or subtract from the function map. Enter the second number of the calculation, and select =. The calculator performs operations in the order they are entered. The result of the calculation remains in the editor field and can be used as the first number of a new calculation.

The device saves the result of the last calculation in its memory. Exiting the Calculator application or switching off the device does not clear the memory. To recall the last saved result the next time you open the Calculator application, select **Options** > **Last result**.

To save the numbers or results of a calculation, select **Options** > **Memory** > **Save**.

To retrieve the results of a calculation from the memory and use them in a calculation, select **Options** > **Memory** > **Recall**.

### Active notes

Active notes allows you to create notes that contain images and sound or video clips. You can also link a note to a contact. The note is displayed during a call with the contact.

### Create and edit notes

Select  > **Applications** > **Office** > **Active notes**.

To create a note, start writing.

To edit a note, select the note and **Options** > **Editing options**.

Select **Options** and from the following:

- **Insert object** — Insert images, sound or video clips, business cards, web bookmarks, and files.
- **Insert new** — Add new items to the note. You can record sound and video clips, and capture images.
- **Send** — Send the note.

- **Link note to call** — Select **Add contacts** to link a note to a contact. The note is displayed when making a call to or receiving a call from the contact.

### Settings for Active notes

Select  > **Applications** > **Office** > **Active notes** and **Options** > **Settings**.

To select where to save notes, select **Memory in use** and the desired memory.

To change the layout of active notes, or to view the notes as a list, select **Change view** > **Grid** or **List**.

To see a note in the background when making or receiving phone calls, select **Show note during call** > **Yes**.

 **Tip:** If you temporarily do not want to see notes during phone calls, select **Show note during call** > **No**. This way you do not have to remove the links between notes and contact cards.

## Notes

### Write notes

Select  > **Applications** > **Office** > **Notes**. To write a note, start entering the text. The note editor opens automatically.

You can save plain text files (.txt file format) you receive to Notes.

### Manage notes

Select  > **Applications** > **Office** > **Notes**.

Select **Options** and from the following:

- **Open** — Open the note.
- **Send** — Send the note to other compatible devices.
- **Delete** — Delete a note. You can also delete several notes at once. To mark each note you want to delete, select **Options** > **Mark/Unmark**, and delete the notes.
- **Synchronisation** — Synchronise the notes with compatible applications on a compatible device, or define the synchronisation settings.

### Zip manager

Select  > **Applications** > **Office** > **Zip**.

With Zip manager, you can create new archive files to store compressed ZIP formatted files; add single or multiple compressed files or directories to an archive; set, clear, or change the archive password for protected archives; and change settings, such as compression level, and file name encoding.

You can save the archive files in the device memory or on a memory card.

## Settings

# 16. Settings

## Application settings

Select  > **Settings** > **Settings and Applications**.  
Select an application from the list to adjust its settings.

## Device and SIM card security

Select  > **Settings** > **Settings** > **General** > **Security**.

To change the PIN code, select **Phone and SIM card** > **PIN code**. The new code must be 4 to 8 digits long. The PIN code protects your SIM card against unauthorised use and is provided with the SIM card. After three consecutive incorrect PIN code entries, the code is blocked, and you need to use the PUK code to unblock it before you can use the SIM card again.

To set the keypad to lock automatically after a defined period, select **Phone and SIM card** > **Keypad autolock period**.

To set a time-out period after which the device is automatically locked and can be used only if the correct lock code is entered, select **Phone and SIM card** > **Phone autolock period**. Enter the length of the time-out period in minutes, or select **None** to deactivate the autolock feature. When the device is locked, you can still answer incoming calls, and calls may still be possible to the official emergency number programmed into your device.

To change the lock code, select **Phone and SIM card** > **Lock code**. The default lock code is 12345. Enter the current code and then the new code twice. The new code must be 4-255

characters long. Alphanumeric (uppercase and lowercase) characters can be used. The device notifies you if the lock code is not properly formatted.

## Common accessory settings

Select  > **Settings** > **Settings and General** > **Enhancement**.

With most accessories, you can do the following:

To define which profile is activated when you attach an accessory to your device, select the accessory and **Default profile**.

To set the device to answer phone calls automatically after 5 seconds when an accessory is attached, select **Automatic answer** > **On**. If the ringing type is set to **Beep once** or **Silent** in the selected profile, automatic answering is disabled.

To illuminate the device while it is attached to an accessory, select **Lights** > **On**.

## Restore original settings

To restore the original device settings, select  > **Settings** > **Settings and General** > **Factory settings**. To do this, you need your device lock code. After resetting, the device may take a longer time to switch on. Documents,

contact information, calendar entries, and files are unaffected.

## 17. Data management

### Install or remove applications

#### Install applications

Select  > **Applications** > **Installations** > **App. mgr..**

You can transfer installation files to your device from a compatible computer, download them during browsing, or receive them in a multimedia message, as an e-mail attachment, or using other connectivity methods, such as Bluetooth connectivity. You can use Nokia Application Installer in Nokia Ovi Suite to install an application to your device.

Icons in Application manager indicate the following:

 SIS or SISX application

 Java™ application

 **Important:** Only install and use applications and other software from trusted sources, such as applications that are Symbian Signed or have passed the Java Verified testing.

Before installation, note the following:

- To view the application type, version number, and the supplier or manufacturer of the application, select **Options** > **View details**.

To display the security certificate details of the application, select **Details:** > **Certificates:** > **View details**.

- If you install a file that contains an update or repair to an existing application, you can only restore the original application if you have the original installation file or a full backup copy of the removed software package. To restore the original application, remove the application, and install the application again from the original installation file or the backup copy.

The JAR file is required for installing Java applications. If it is missing, the device may ask you to download it. If there is no access point defined for the application, you are asked to select one. When you are downloading the JAR file, you may need to enter a user name and password to access the server. You obtain these from the supplier or manufacturer of the application.

To install software or an application, do the following:

1. To locate an installation file, select  > **Applications** > **Installations** > **App. mgr..** Alternatively, search for installation files using File manager, or select **Messaging** > **Inbox**, and open a message that contains an installation file.
2. In Application manager, select **Options** > **Install**. In other applications, select the installation file to start the installation.

## Data management

During installation, the device displays information about the progress of the installation. If you install an application without a digital signature or certification, the device displays a warning. Continue installation only if you are sure of the origin and contents of the application.

To start an installed application, locate the application in the menu, and select the application.

To see which software packages are installed or removed and when, select **Options** > **View log**.



**Important:** Your device can only support one antivirus application. Having more than one application with antivirus functionality could affect performance and operation or cause the device to stop functioning.

After you install applications to a compatible memory card, installation files (.sis, .sisx) remain in the device memory. The files may use large amounts of memory and prevent you from storing other files. If the .sis file is a message attachment, delete the message from the Messaging inbox.

## Remove applications and software

Select  > **Applications** > **Installations** > **App. mgr..**

Scroll to a software package, and select **Options** > **Remove**. Select **Yes** to confirm.

If you remove software, you can only reinstall it if you have the original software package or a full backup of the removed software package. If you remove a software package, you

may no longer be able to open documents created with that software.

If another software package depends on the software package that you removed, the other software package may stop working. For more information, see the documentation of the installed software package.

## File manager

### About File manager

Select  > **Applications** > **Office** > **File mgr..**

With File manager, you can browse, manage, and open files.

The available options may vary.

To map or delete drives, or to define settings for a compatible remote drive connected to your device, select **Options** > **Remote drives**.

### Find and organise files

Select  > **Applications** > **Office** > **File mgr..**

To find a file, select **Options** > **Find**. Enter a search term that matches the file name.

To move and copy files and folders, or to create new folders, select **Options** > **Organise**.



**Shortcut:** To apply actions to multiple items at once, mark the items. To mark or unmark items, press #.

### Back up files to a memory card

Select  > **Applications** > **Office** > **File mgr..**

**Data management**

To back up files to a memory card, select the file types you want to back up, and **Options** > **Back up phone memory**. Ensure that your memory card has enough free memory for the files that you have chosen to back up.

**Manage a memory card**

Select  > **Applications** > **Office** > **File mgr.**.

These options are available only if a compatible memory card is inserted in the device.

Select **Options** and from the following:

- **Memory card options** — Rename or format a memory card.
- **Memory card password** — Password protect a memory card.
- **Unlock memory card** — Unlock a memory card.

**Device manager****Remote configuration**

Select  > **Settings** > **Device manager**.

With Device manager, you can manage settings, data, and software on your device remotely.

You can connect to a server, and receive configuration settings for your device. You may receive server profiles and different configuration settings from your service providers or company information management department. Configuration settings may include connection and other settings used by different applications in your device. The available options may vary.

The remote configuration connection is usually started by the server when the device settings need to be updated.

To create a new server profile, select **Options** > **Server profiles** > **Options** > **New server profile**.

You may receive these settings from your service provider in a configuration message. If not, define the following:

- **Server name** — Enter a name for the configuration server.
- **Server ID** — Enter the unique ID to identify the configuration server.
- **Server password** — Enter a password to identify your device to the server.
- **Session mode** — Select the preferred connection type.
- **Access point** — Select the access point to use for the connection, or create a new access point. You can also choose to be asked for the access point every time you start a connection. This setting is available only if you have selected **Internet** as the bearer type.
- **Host address** — Enter the web address of the configuration server.
- **Port** — Enter the port number of the server.
- **User name and Password** — Enter your user ID and password for the configuration server.
- **Allow configuration** — Select **Yes** to allow the server to initiate a configuration session.
- **Auto-accept all requests** — Select **Yes** if you do not want the server to ask for your confirmation when it initiates a configuration session.
- **Network authentication** — Select whether to use http authentication.

## Connectivity

- **Network user name** and **Network password** — Enter your user ID and password for the http authentication. This setting is available only if you have selected **Network authentication** to be used.

To connect to the server and receive configuration settings for your device, select **Options** > **Start configuration**.

To view the configuration log of the selected profile, select **Options** > **View log**.

To update the device software over the air, select **Options** > **Settings**. The update does not erase your settings. When you receive the update package on your device, follow the instructions on the display. Your device is restarted once the installation is complete. Downloading software updates may involve the transmission of large amounts of data through your service provider's network. Contact your service provider for information about data transmission charges. Make sure that the device battery has enough power, or connect the charger before starting the update.

## Update device software

Software updates may include new features and enhanced functions that were not available at the time of purchase of

your device. Updating the software may also improve the device performance.

Nokia Software Updater is a PC application that enables you to update your device software. To update your device software, you need a compatible PC, broadband internet access, and a compatible USB data cable to connect your device to the PC.

To get more information, to check the release notes for the latest software versions, and to download the Nokia Software Updater application, see [www.nokia.com/softwareupdate](http://www.nokia.com/softwareupdate) or your local Nokia website.

To update the device software, do the following:

1. Download and install the Nokia Software Updater application to your PC.
2. Connect your device to the PC using a USB data cable, and start the Nokia Software Updater application. The Nokia Software Updater application guides you to back up your files, update the software, and restore your files.

# 18. Connectivity

## Transfer content from another device

Select  > **Settings** > **Switch**.

With the Switch application, you can transfer content, such as contacts, between two compatible Nokia devices.

The type of content that can be transferred depends on the model of the device from which you want to transfer content.



**Connectivity**

If the other device supports synchronisation, you can also synchronise data between the other device and your device. Your device notifies you if the other device is not compatible.

If the other device cannot be switched on without a SIM card, you can insert your SIM card in it. When your device is switched on without a SIM card, the offline profile is automatically activated.

**Transfer content**

To retrieve data from your other device for the first time:

1. Select the connection type you want to use to transfer the data. Both devices must support the selected connection type.
2. Select the device from which you want to transfer content. You are asked to enter a code on your device. Enter a code (1-16 digits), and select **OK**. Enter the same code on the other device, and select **OK**. The devices are now paired.

For some device models, the Switch application is sent to the other device as a message. To install the Switch application on the other device, open the message, and follow the instructions.

3. From your device, select the content you want to transfer from the other device.

Content is transferred from the memory of the other device to the corresponding location in your device.

Transfer time depends on the amount of data to be transferred. You can cancel the transfer and continue later.

The synchronisation is two-way, and the data in both devices is the same. If an item is deleted from either device, it is

deleted from the other device when synchronising; you cannot restore deleted items by synchronising.

To view the log of the last transfer, select a shortcut in the main view and **Options > View log**.

**PC connections**

You can use your mobile device with a variety of compatible PC connectivity and data communications applications. With Nokia Ovi Suite, you can, for example, transfer files and images between your device and a compatible computer.

For more information about Ovi Suite and the download link, see [www.ovi.com](http://www.ovi.com).

**Bluetooth  
About Bluetooth**

Bluetooth technology enables wireless connections between electronic devices within a range of 10 metres (33 feet). A Bluetooth connection can be used to send images, videos, text, business cards, calendar notes, or to connect wirelessly to devices that use Bluetooth technology.

Since devices using Bluetooth technology communicate using radio waves, your device and the other devices do not need to be in direct line-of-sight. The two devices only need to be within a maximum of 10 metres of each other, although the connection can be subject to interference from obstructions such as walls or other electronic devices.

Several Bluetooth connections can be active at a time. For example, if your device is connected to a headset, you can

## Connectivity

also transfer files to another compatible device at the same time.

This device is compliant with Bluetooth Specification 2.0 + EDR supporting the following profiles: Advanced Audio Distribution, Audio/Video Remote Control, Basic Imaging, Basic Printing, Device ID, Dial-up Networking, File Transfer, Generic Audio/Video Distribution, Generic Access, Generic Object Exchange, Handsfree, (Human Interface Device) Headset, Object Push, Phone Book Access, Serial Port, and SIM Access. To ensure interoperability between other devices supporting Bluetooth technology, use Nokia approved accessories for this model. Check with the manufacturers of other devices to determine their compatibility with this device.

Features using Bluetooth technology increase the demand on battery power and reduce the battery life.

### Security tips

When you are not using Bluetooth connectivity, select **Bluetooth > Off** or **My phone's visibility > Hidden**.

Do not pair with an unknown device.

### Send and receive data with Bluetooth

Select  > **Settings > Connectivity > Bluetooth**.

1. When you activate Bluetooth connectivity for the first time, you are asked to name your device. Give your device a unique name to make it easy to recognise if there are several Bluetooth devices nearby.
2. Select **Bluetooth > On**.

3. Select **My phone's visibility > Shown to all** or **Define period**. If you select **Define period**, you need to define the time during which your device is visible to others. Your device and the name you entered can now be seen by other users with devices using Bluetooth technology.

4. Open the application where the item you want to send is stored.

5. Select the item and **Options > Send > Via Bluetooth**. The device searches for other devices using Bluetooth technology within range and lists them.



**Tip:** If you have sent data using Bluetooth connectivity before, a list of the previous search results is displayed. To search for more Bluetooth devices, select **More devices**.

6. Select the device with which you want to connect. If the other device requires pairing before data can be transmitted, you are asked to enter a passcode.

When the connection has been established, **Sending data** is displayed.

The Sent folder in the Messaging application does not store messages sent using Bluetooth connectivity.

To receive data using Bluetooth connectivity, select **Bluetooth > On** and **My phone's visibility > Shown to all** to receive data from a non-paired device or **Hidden** to receive data from a paired device only. When you receive data through Bluetooth connectivity, depending on the settings of an active profile, a tone sounds, and you are asked if you want to accept the message in which the data is included. If

**Connectivity**

you accept, the message is placed in the Inbox folder in the Messaging application.

 **Tip:** You can access the files in the device or on the memory card using a compatible accessory that supports the File Transfer Profile Client service (for example, a laptop computer).

A Bluetooth connection is disconnected automatically after sending or receiving data. Only Nokia Ovi Suite and some accessories such as headsets may maintain a connection even if not actively used.

**Pair devices**

Select  > **Settings** > **Connectivity** > **Bluetooth**.

Open the paired devices tab.

Before pairing, decide on your own passcode (1-16 digits), and agree with the user of the other device to use the same code. Devices that do not have a user interface have a fixed passcode. You need the passcode only when you connect the devices for the first time. After pairing, it is possible to authorise the connection. Pairing and authorising the connection makes connecting quicker and easier, as you do not have to accept the connection between paired devices every time you establish a connection.

The passcode for remote SIM access must have 16 digits.

1. Select **Options** > **New paired device**. The device starts to search for Bluetooth devices within range. If you have sent data using Bluetooth connectivity before, a list of the previous search results is displayed. To search for more Bluetooth devices, select **More devices**.

2. Select the device with which you want to pair, and enter the passcode. The same passcode must be entered to the other device as well.

3. Select **Yes** to make the connection between your device and the other device automatic, or **No** to confirm the connection manually every time a connection attempt is made. After pairing, the device is saved to the paired devices page.

To give a nickname to the paired device, select **Options** > **Assign short name**. The nickname is only displayed in your device.

To delete a pairing, select the device whose pairing you want to delete and **Options** > **Delete**. To delete all pairings, select **Options** > **Delete all**. If you are currently connected to a device and cancel the pairing with that device, pairing is removed immediately, and the connection is ended.

To allow a paired device to connect automatically to your device, select **Set as authorised**. Connections between your device and the other device can be made without your knowledge. No separate acceptance or authorisation is needed. Use this status for your own devices, such as your compatible headset or computer, or devices that belong to someone you trust. If you want to accept connection requests from the other device separately every time, select **Set as unauthorised**.

To use a Bluetooth audio accessory such as a Bluetooth handsfree or headset, you need to pair your device with the accessory. For the passcode and further instructions, see the accessory user guide. To connect to the audio accessory,

## Connectivity

switch on the accessory. Some audio accessories connect automatically to your device. Otherwise, open the paired devices tab, select the accessory and **Options > Connect to audio device**.

## Block devices

Select  > **Settings > Connectivity > Bluetooth**.

To block a device from establishing a Bluetooth connection to your device, open the paired devices tab. Select a device you want to block and **Options > Block**.

To unblock a device, open the blocked devices tab, and select **Options > Delete**. To unblock all blocked devices, select **Options > Delete all**.

If you reject a pairing request from another device, you are asked if you want to block all future connection requests from this device. If you accept the query, the remote device is added to the list of blocked devices.

## Data cable

To avoid damaging the memory card or corrupting data, do not disconnect the USB data cable during a data transfer.

### Transfer data between your device and a PC

1. Insert a memory card in your device, and connect the device to a compatible PC using the USB data cable.
2. When the device asks which mode to use, select **Mass storage**. In this mode, you can see your device as a removable hard drive in the PC.

3. Transfer the desired data between the PC and your device.

4. End the connection from the PC (for example, from an Unplug or Eject Hardware wizard in Windows) to avoid damaging the memory card.

To modify the USB mode settings, select  > **Settings > Connectivity > USB**.

To change the USB mode you normally use with the data cable, select **USB connection mode**.

To set the device to ask which mode to use each time you connect the USB data cable to the device, select **Ask on connection > Yes**.

To use Nokia PC Suite with your device, install Nokia PC Suite on your PC, connect the USB data cable, and select **PC Suite**.

## Sync

Select  > **Settings > Connectivity > Sync**.

Sync enables you to synchronise your notes, calendar entries, text and multimedia messages, browser bookmarks, or contacts with various compatible applications on a compatible computer or on the internet.

You may receive synchronisation settings in a special message from your service provider.

A synchronisation profile contains the necessary settings for synchronisation.

When you open the Sync application, the default or previously used sync profile is displayed. To modify the profile, scroll to

### Green tips

a sync item, and select **Mark** to include it in the profile or **Unmark** to leave it out.

To manage sync profiles, select **Options** and the desired option.

To synchronise data, select **Options** > **Synchronise**. To cancel synchronisation before it finishes, select **Cancel**.

## 19. Green tips

Here are tips on how you can contribute to protecting the environment.

### Save energy

When you have fully charged the battery and disconnected the charger from the device, remember to also unplug the charger from the wall outlet.

You do not need to charge your battery so often if you do the following:

- Close and disable applications, services, and connections when you are not using them.
- Decrease the brightness of the screen.
- Set the device to enter the power saver mode after the minimum period of inactivity, if available in your device.
- Disable unnecessary sounds, such as keypad tones. Set the volume of your device to an average level.



### Recycle

Did you remember to recycle your old device? 65-80% of the materials in a Nokia mobile phone can be recycled. Always return your used electronic products, batteries, and packaging materials to a dedicated collection point. By doing this, you help prevent uncontrolled waste disposal and promote the recycling of materials. Check how to recycle your Nokia products at [www.nokia.com/werecycle](http://www.nokia.com/werecycle) or [www.nokia.mobi/werecycle](http://www.nokia.mobi/werecycle).

You may recycle the packaging and user guides at your local recycling scheme.

### Save paper

This user guide helps you get started with your device. For more comprehensive instructions, open the help function that is included in your device (in most applications, select **Options** > **Help**). You can also find user guides and other support at [www.nokia.com/support](http://www.nokia.com/support).

**Green tips**

**Learn more**

For more information on the environmental attributes of your device, see [www.nokia.com/ecodeclaration](http://www.nokia.com/ecodeclaration).

D  
R  
A  
F  
T



## Accessories

For availability of approved accessories, please check with your dealer. When you disconnect the power cord of any accessory, grasp and pull the plug, not the cord.

## Battery

### Battery and charger information

Your device is powered by a rechargeable battery. The battery intended for use with this device is BL-5CT. Nokia may make additional battery models available for this device. This device is intended for use when supplied with power from the following chargers: AC-8. The exact charger model number may vary depending on the type of plug. The plug variant is identified by one of the following: E, EB, X, AR, U, A, C, K, or UB.

The battery can be charged and discharged hundreds of times, but it will eventually wear out. When the talk and standby times are noticeably shorter than normal, replace the battery. Use only Nokia approved batteries, and recharge your battery only with Nokia approved chargers designated for this device.

If a battery is being used for the first time or if the battery has not been used for a prolonged period, it may be necessary to connect the charger, then disconnect and reconnect it to begin charging the battery. If the battery is completely discharged, it may take several minutes before the charging

indicator appears on the display or before any calls can be made.

**Safe removal.** Always switch the device off and disconnect the charger before removing the battery.

**Proper charging.** Unplug the charger from the electrical plug and the device when not in use. Do not leave a fully charged battery connected to a charger, since overcharging may shorten its lifetime. If left unused, a fully charged battery will lose its charge over time.

**Avoid extreme temperatures.** Always try to keep the battery between 15°C and 25°C (59°F and 77°F). Extreme temperatures reduce the capacity and lifetime of the battery. A device with a hot or cold battery may not work temporarily. Battery performance is particularly limited in temperatures well below freezing.

**Do not short-circuit.** Accidental short-circuiting can occur when a metallic object such as a coin, clip, or pen causes direct connection of the positive (+) and negative (-) terminals of the battery. (These look like metal strips on the battery.) This might happen, for example, when you carry a

### Taking care of your device

spare battery in your pocket or purse. Short-circuiting the terminals may damage the battery or the connecting object. Disposal. Do not dispose of batteries in a fire as they may explode. Dispose of batteries according to local regulations. Please recycle when possible. Do not dispose as household waste.

Leak. Do not dismantle, cut, open, crush, bend, puncture, or shred cells or batteries. In the event of a battery leak, prevent battery liquid contact with skin or eyes. If this happens, flush the affected areas immediately with water, or seek medical help.

Damage. Do not modify, remanufacture, attempt to insert foreign objects into the battery, or immerse or expose it to water or other liquids. Batteries may explode if damaged.

Correct use. Use the battery only for its intended purpose. Improper battery use may result in a fire, explosion, or other hazard. If the device or battery is dropped, especially on a hard surface, and you believe the battery has been damaged, take it to a service centre for inspection before continuing to use it. Never use any charger or battery that is damaged. Keep your battery out of the reach of small children.

## Nokia battery authentication guidelines

Always use original Nokia batteries for your safety. To check that you are getting an original Nokia battery, purchase it

from a Nokia authorised service centre or dealer, and inspect the hologram label using the following steps:

### Authenticate hologram

1. When you look at the hologram on the label, you should see the Nokia connecting hands symbol from one angle and the Nokia Original Enhancements logo when looking from another angle.
2. When you angle the hologram left, right, down and up, you should see 1, 2, 3 and 4 dots on each side respectively.

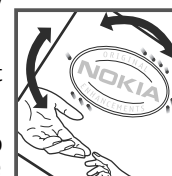
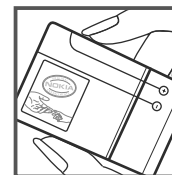

Successful completion of the steps is not a total assurance of the authenticity of the battery. If you cannot confirm authenticity or if you have any reason to believe that your Nokia battery with the hologram on the label is not an authentic Nokia battery, you should refrain from using it, and take it to the nearest Nokia authorised service centre or dealer for assistance.

To find out more about original Nokia batteries, see [www.nokia.com/battery](http://www.nokia.com/battery).



## Taking care of your device

Your device is a product of superior design and craftsmanship and should be treated with care. The following suggestions will help you protect your warranty coverage.

- Keep the device dry. Precipitation, humidity, and all types of liquids or moisture can contain minerals that will corrode electronic circuits. If your device does get wet, remove the battery, and allow the device to dry completely before replacing it.
- Do not use or store the device in dusty, dirty areas. Its moving parts and electronic components can be damaged.
- Do not store the device in high or cold temperature. High temperatures can shorten the life of electronic devices, damage batteries, and warp or melt certain plastics. When the device warms to its normal temperature from a cold temperature, moisture can form inside the device and damage electronic circuit boards.
- Do not attempt to open the device other than as instructed in this guide.
- Do not drop, knock, or shake the device. Rough handling can break internal circuit boards and fine mechanics.
- Do not use harsh chemicals, cleaning solvents, or strong detergents to clean the device. Only use a soft, clean, dry cloth to clean the surface of the device.
- Do not paint the device. Paint can clog the moving parts and prevent proper operation.

- Use only the supplied or an approved replacement antenna. Unauthorised antennas, modifications, or attachments could damage the device and may violate regulations governing radio devices.
- Use chargers indoors.
- Backup all data you want to keep, such as contacts and calendar notes.
- To reset the device from time to time for optimum performance, power off the device and remove the battery.

These suggestions apply equally to your device, battery, charger, or any accessory.

## Recycle

Always return your used electronic products, batteries, and packaging materials to dedicated collection points. This way you help prevent uncontrolled waste disposal and promote the recycling of materials. Check product environmental information and how to recycle your Nokia products at [www.nokia.com/wecycle](http://www.nokia.com/wecycle), or [nokia.mobi/wecycle](http://nokia.mobi/wecycle).

 The crossed-out wheeled-bin symbol on your product, battery, literature, or packaging reminds you that all electrical and electronic products, batteries, and accumulators must be taken to separate collection at the end of their working life. This requirement applies in the European Union. Do not dispose of these products as

### Additional safety information

unsorted municipal waste. For more environmental information, see the product Eco-Declarations at [www.nokia.com/environment](http://www.nokia.com/environment).

## Additional safety information

### Small children

Your device and its accessories are not toys. They may contain small parts. Keep them out of the reach of small children.

### Operating environment

This device meets RF exposure guidelines in the normal use position at the ear or at least 2.2 centimetres (7/8 inch) away from the body. Any carry case, belt clip, or holder for body-worn operation should not contain metal and should position the device the above-stated distance from your body.

To send data files or messages requires a quality connection to the network. Data files or messages may be delayed until such a connection is available. Follow the separation distance instructions until the transmission is completed.

### Medical devices

Operation of radio transmitting equipment, including wireless phones, may interfere with the function of inadequately protected medical devices. Consult a physician or the manufacturer of the medical device to determine whether they are adequately shielded from external RF energy. Switch off your device when regulations posted

instruct you to do so. Hospitals or health care facilities may use equipment sensitive to external RF energy.

### Implanted medical devices

Manufacturers of medical devices recommend a minimum separation of 15.3 centimetres (6 inches) between a wireless device and an implanted medical device, such as a pacemaker or implanted cardioverter defibrillator, to avoid potential interference with the medical device. Persons who have such devices should:

- Always keep the wireless device more than 15.3 centimetres (6 inches) from the medical device.
- Not carry the wireless device in a breast pocket.
- Hold the wireless device to the ear opposite the medical device.
- Turn the wireless device off if there is any reason to suspect that interference is taking place.
- Follow the manufacturer directions for the implanted medical device.

If you have any questions about using your wireless device with an implanted medical device, consult your health care provider.

## Hearing aids

Some digital wireless devices may interfere with some hearing aids.

## Vehicles

RF signals may affect improperly installed or inadequately shielded electronic systems in motor vehicles such as electronic fuel injection, electronic antilock braking, electronic speed control, and air bag systems. For more information, check with the manufacturer of your vehicle or its equipment.

Only qualified personnel should service the device or install the device in a vehicle. Faulty installation or service may be dangerous and may invalidate your warranty. Check regularly that all wireless device equipment in your vehicle is mounted and operating properly. Do not store or carry flammable liquids, gases, or explosive materials in the same compartment as the device, its parts, or accessories. Remember that air bags inflate with great force. Do not place your device or accessories in the air bag deployment area.

Switch off your device before boarding an aircraft. The use of wireless teledevices in an aircraft may be dangerous to the operation of the aircraft and may be illegal.

## Potentially explosive environments

Switch off your device in any area with a potentially explosive atmosphere. Obey all posted instructions. Sparks in such areas could cause an explosion or fire resulting in bodily injury or death. Switch off the device at refuelling points such

## Additional safety information

as near gas pumps at service stations. Observe restrictions in fuel depots, storage, and distribution areas; chemical plants; or where blasting operations are in progress. Areas with a potentially explosive atmosphere are often, but not always, clearly marked. They include areas where you would be advised to turn off your vehicle engine, below deck on boats, chemical transfer or storage facilities and where the air contains chemicals or particles such as grain, dust, or metal powders. You should check with the manufacturers of vehicles using liquefied petroleum gas (such as propane or butane) to determine if this device can be safely used in their vicinity.

## Emergency calls

 **Important:** This device operates using radio signals, wireless networks, landline networks, and user-programmed functions. If your device supports voice calls over the internet (internet calls), activate both the internet calls and the cellular phone. The device may attempt to make emergency calls over both the cellular networks and through your internet call provider if both are activated. Connections in all conditions cannot be guaranteed. You should never rely solely on any wireless device for essential communications like medical emergencies.

To make an emergency call:

1. If the device is not on, switch it on. Check for adequate signal strength. Depending on your device, you may also need to complete the following:
  - Insert a SIM card if your device uses one.

### Additional safety information

- Remove certain call restrictions you have activated in your device.
  - Change your profile from Offline or Flight profile to an active profile.
2. Press the end key as many times as needed to clear the display and ready the device for calls.
  3. Enter the official emergency number for your present location. Emergency numbers vary by location.
  4. Press the call key.

When making an emergency call, give all the necessary information as accurately as possible. Your wireless device may be the only means of communication at the scene of an accident. Do not end the call until given permission to do so.

### Certification information (SAR)

#### This mobile device meets guidelines for exposure to radio waves.

Your mobile device is a radio transmitter and receiver. It is designed not to exceed the limits for exposure to radio waves recommended by international guidelines. These guidelines were developed by the independent scientific organisation ICNIRP and include safety margins designed to assure the protection of all persons, regardless of age and health.

The exposure guidelines for mobile devices employ a unit of measurement known as the Specific Absorption Rate or SAR. The SAR limit stated in the ICNIRP guidelines is 2.0 watts/kilogram (W/kg) averaged over 10 grams of tissue. Tests for SAR are conducted using standard operating positions with

the device transmitting at its highest certified power level in all tested frequency bands. The actual SAR level of an operating device can be below the maximum value because the device is designed to use only the power required to reach the network. That amount changes depending on a number of factors such as how close you are to a network base station. The highest SAR value under the ICNIRP guidelines for use of the device at the ear is 1.24 W/kg.

Use of device accessories may result in different SAR values. SAR values may vary depending on national reporting and testing requirements and the network band. Additional SAR information may be provided under product information at [www.nokia.com](http://www.nokia.com).

Your mobile device is also designed to meet the requirements for exposure to radio waves established by the Federal Communications Commission (USA) and Industry Canada. These requirements set a SAR limit of 1.6 W/kg averaged over one gram of tissue. The highest SAR value reported under this standard during product certification for use at the ear is 1.13 W/kg and when properly worn on the body is 0.62 W/kg.

## Index

### A

- access codes** 16
- accessories**
  - settings 52
- active notes** 50
  - settings 51
- alarm**
  - calendar note 47
- alarm clock** 48
- animated screen saver** 46
- anniversary notes** 47
- antennas** 11
- application settings** 52
- audio messages** 33
- auto-update for time/date** 48
- autolock period** 52

### B

- background image** 46
- barring password** 16
- battery** 9
  - charge level 14
  - charging 10
- birthday notes** 47
- blogs** 41
- Bluetooth**
  - authorising devices 59
  - pairing 59

- passcode 59
- receiving data 58
- security 58
- sending data 58

### Bluetooth connectivity

- blocking devices 60

### browser

- browsing pages 40
- cache memory 41
- security 42

### C

- cable** 60
- cache memory** 41
- calculator** 50
- calendar** 47
- call barring** 24
- call divert** 24
- caller ID** 23
- calls**
  - answering 22
  - call waiting 23
  - caller ID 23
  - conference call 21
  - making 20
  - muting the ringing tone 22
  - rejecting 22
  - rejecting with text message 23
  - selecting type 23

- settings 23
- speed dialling 21
- voice mail 21

### camera

- capturing images 39
- toolbar 39
- video clips 40

### charging the battery

### Clock

- settings 48

### computer connections

See also *data connections*

### conference calls

### configuration settings

### connection methods

- Bluetooth 58
- data cable 60

### connections

- PC connection 42

### contact information

### contacts

- copying 38
- editing 38
- images in 38
- names and numbers 38
- ringing tones 38
- saving 38
- sending 38
- synchronising 60

**Index**

voice tags 38  
**Contacts on Ovi** 42  
**converter** 49, 50  
**currency**  
 converter 49  
**customer service** 19

**D**

**data connections**  
 PC connectivity 57  
 synchronisation 60  
**date and time** 48  
**device manager** 55  
**dictionary** 48  
**display**  
 changing the look 46  
 indicators 14  
**Download!** 17

**E**

**e-mail**  
 accounts 37  
 adding attachments 35  
 deleting 36  
 disconnecting 37  
 downloading attachments 36  
 folders 37  
 general settings 37  
 out-of-office reply 37  
 reading 35  
 searching 36

sending 35  
 set-up 35

**F**

**feeds, news** 41  
**FM radio** 27

**H**

**headphones** 17  
**headset** 17  
**help application** 18  
**home screen** 13

**I**

**indicators** 14  
**installations** 17  
**installing applications** 53  
**internet connection** 40  
*See also browser*

**K**

**keyguard** 16  
**keypad**  
 lock settings 52  
**keypad lock** 16  
**keys and parts** 12

**L**

**landmarks** 30

**language**  
 changing 32  
**lock code** 52  
**locking**  
 device autolock 52  
 keypad 52  
**locking device** 17  
**log** 22

**M**

**maintenance** 19  
**making a call** 20  
**maps** 29  
 browsing 29  
 indicators 30  
**media**  
 radio 27  
**meeting notes** 47  
**meeting requests**  
 receiving 36  
**meetings**  
 setting up 47  
**memo notes**  
*See to-do notes*  
**memory**  
 web cache 41  
**memory card** 9, 10  
**menu** 15  
**menu view** 15  
**messages**  
 call rejection messages 23

**MMS (multimedia message service)** 33  
**modem** 42  
**multimedia messages** 33  
**music player**  
   playing 26  
   transferring music 27  
**music search** 27  
**My Nokia** 19

## N

**network**  
   settings 25  
**news feeds** 41  
**Nokia Sports Tracker** 31  
**notes** 51

## O

**offline** 14  
**operator**  
   selecting 25  
**original settings** 52  
**out-of-office reply** 37  
**Own key** 13

## P

**pairing**  
   devices 59  
   passcode 59  
**PDF reader** 48  
**personalisation** 46

**PIN** 16  
**PIN code**  
   changing 52  
**power saver** 15  
**predictive text input** 32  
**profiles**  
   creating 46  
   customising 46  
**PUK** 16

## R

**radio** 27  
   listening 27  
**remote configuration** 55  
**remote lock** 17  
**repair service** 19  
**restoring original settings** 52

## S

**Say and Play** 27  
**screen saver** 46  
**Search** 46  
**search**  
   music 27  
**security**  
   Bluetooth 58  
   device and SIM card 52  
   web browser 42  
**security code** 16  
**security module** 16

**sending**  
   using Bluetooth 58

## settings

accessories 52  
 active notes 51  
 applications 52  
 calls 23  
 clock 48  
 configuration 11  
 keypad lock 52  
 network 25  
 restoring 52  
**settings wizard** 12

## Share online

activating services 44  
 creating posts 44  
 subscribing 44

**share online** 43  
**signal strength** 14  
**SIM card** 9  
**SMS (short message service)** 33  
**software update** 19  
**software updates** 56  
**speed dialling** 21  
**support information** 19  
**switching the device on and off** 11  
**synchronisation of data** 60

## Index

**Index**

**T**

**text**

- letter mode 31
- number mode 31
- predictive input 32
- traditional input 31

**text messages**

- sending 33

**themes**

- changing 46
- downloading 46

**time and date 48**

**to-do notes 47**

**toolbar**

- camera 39

**traditional text input 31**

**U**

**updates**

- device software 56

**UPIN 16**

**UPIN code**

- changing 52

**USB data cable 60**

**V**

**video calls 23**

- making a call 22
- switching to voice call 22

**Video Centre 44**

**video centre**

- downloading 45
- viewing 45

**video sharing**

- sharing live video 25
- sharing video clips 25

**voice dialling 21**

**voice mail**

- calling 21
- changing number 21

**volume control 16**

**W**

**web connection 40**

**web logs 41**

**week settings**

- calendar alarm 47

**writing language 32**

**Z**

**Zip manager 51**