

Cendence User Guide

V1.0

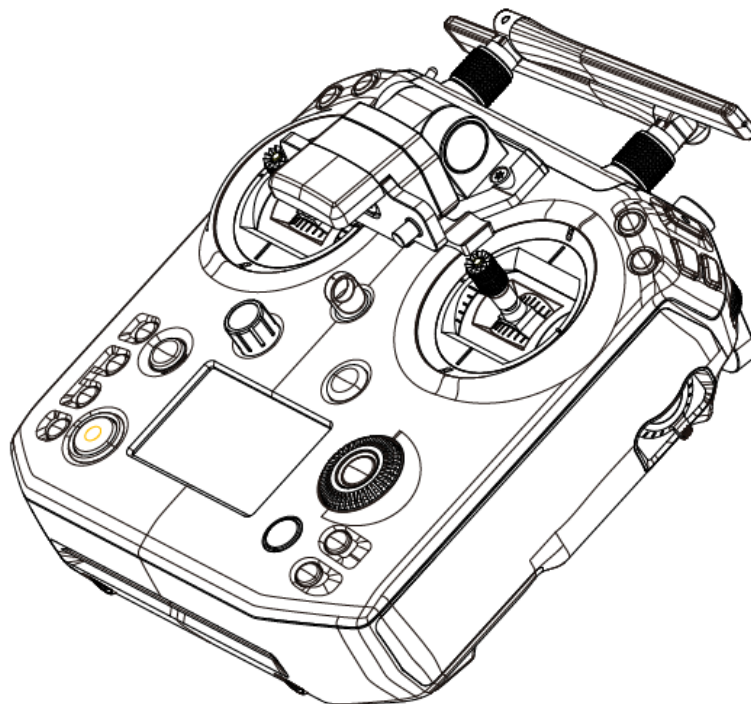

Cendence Remote Controller

The remote controller features DJI's LIGHTBRIDGE™ technology for a maximum transmission distance of up to 4.3 mi (7km).^{*} Dual frequency support makes the HD video downlink more stable. In Dual Remote Controllers, each of the two remote controllers control the aircraft and camera separately. Users can even operate these mechanisms up to 328 feet (100 m) apart. The remote controller works with a WB37 intelligent battery, which can be charged via the charging port (about 2 hours and 24 minutes with an 180W charger) or by the intelligent battery charging hub (about 1 hour and 11 minutes). The maximum run-time of the remote controller is approx. four hours without supplying power to the monitor while master-and-slave function is disabled.^{*}

It can be equipped with a DJI CrystalSky™ monitor (DJI CrystalSky7.85inch is used as example in this guide), you have a live HD view directly within the built-in DJI Pilot™ app or DJI GO™4 app for a precise and responsive flying experience while flying the aircraft.

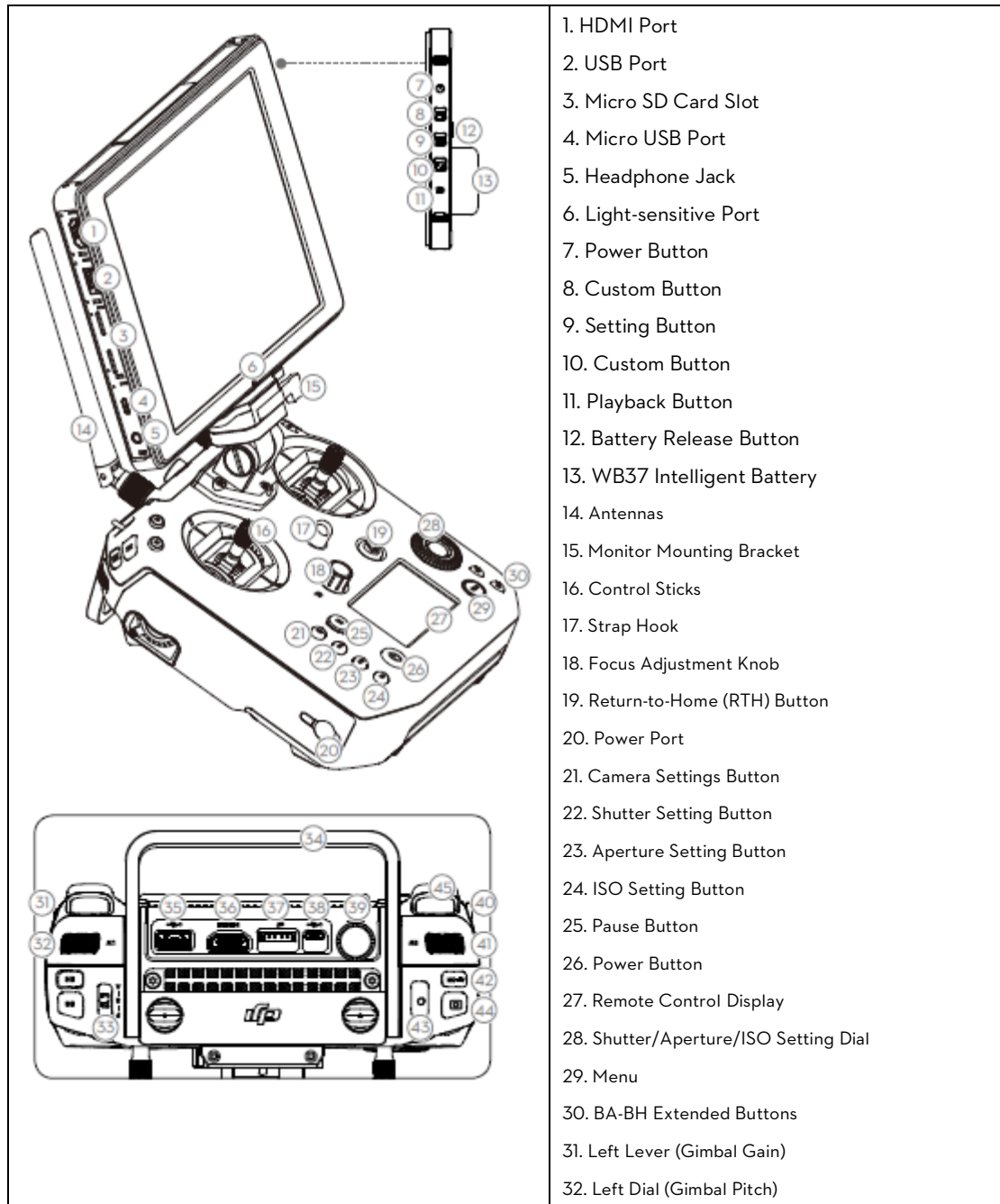

	<ul style="list-style-type: none">33. Flight Mode Switch34. Handle Bar35. USB Port (for Mobile Device Connection)36. HDMI A Port (for Video Output)37. CAN Bus (Extended Port)38. Micro USB Port39. SDI Port (for Video Output)40. Right Lever (Flight Controller Gain)41. Right Dial (Gimbal Pan)42. Focus Button43. Record Button44. Photo Button45. C1-C4 Extended Buttons
--	---

* The remote controller can reach its maximum transmission distance (FCC) in a wide open area with no Electro-Magnetic interference at an altitude of about 400 feet (120 meters).

To comply with local regulations, the operation frequency of 5.8 GHz is not available in some countries.

The maximum run-time is tested without supplying power to a smart device.

Charge the Battery

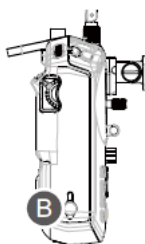

Using IN2CH Charging Hub

Charging Time: 1 hour and 30 min

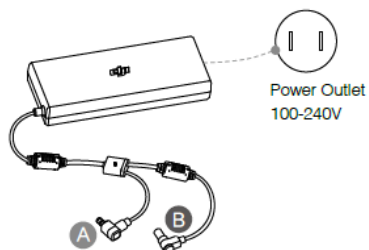

* DJI approved charger

When charging is complete, the display on the remote controller will show 100%.

Prepare the Remote Controller

Mounting the Monitor and Remote Controller's Batteries

It's the same to mount the Monitor and Remote Controller's Batteries.

Put the battery into the Battery Slot, then slide it to the end until you hear a click.

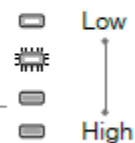
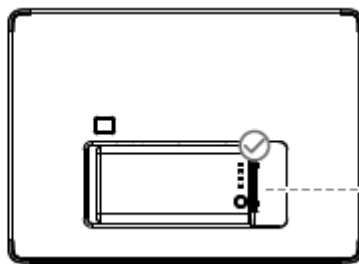
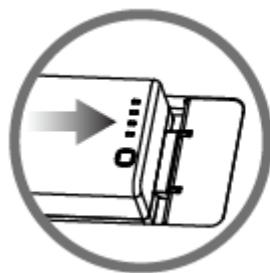

Press the Battery Release Button before removing the battery.

Press the Battery Level Button once to check the battery level.

Mounting the Monitor to the Remote Controller

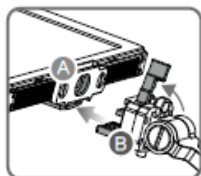

Ensure that Part B is unlocked. Install Part B into Part A.

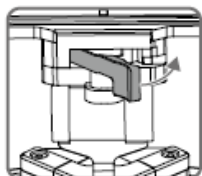

Lock the Mounting Bracket.

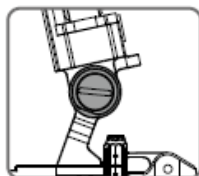

Use a coin to adjust the tightness of the pitch axis.

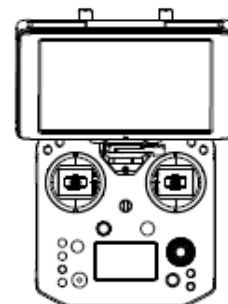

Using the Remote Controller

Stick mode is set to Mode 2 by default (left hand throttle). The left stick controls the aircraft's elevation and heading. The right stick controls the aircraft's forward, backward, and lateral movements. To adjust the FPV camera, press and hold the C2 Button and rotate the left dial.

Left Stick	Right Stick	FPV Camera
	<ul style="list-style-type: none"> You can change the stick mode, and mapping the C1-C4, BA-BH buttons function in the DJI GO app. 	

Specifications

Remote Controller (Cendence)	
Model	GL800A
Power Supply	Extended Intelligent Battery (Model: WB37-4920mAh-7.6V)
Intelligent Battery	4923 mAh LiPo
Charging	DJI charger
Output Power	20 W (supplying power to DJI CS550 monitor); 12 W (without supplying power to monitor)
Video Output Ports	USB, HDMI, SDI
USB Power Supply	iOS: 1 A, 5.2 V (Max); Android: 1.5 A, 5.2 V (Max)
Dual User Capability	Host-and-Slave connection
Operating Temperature	-4° to 104° F (-20° to 40° C)
Storage Temperature	Less than 3 months: -4° to 113° F (-20° to 45° C) More than 3 months: 72° to 82° F (22° to 28° C)
Charging Temperature	32° to 104° F (0° to 40° C)
Charging Time	About 2 hours and 24 minutes (using a 180W charger)
Supply Power Time	About 4 hours (only Master remote controller function enabled and without supplying power to monitor)
Weight	1041 g

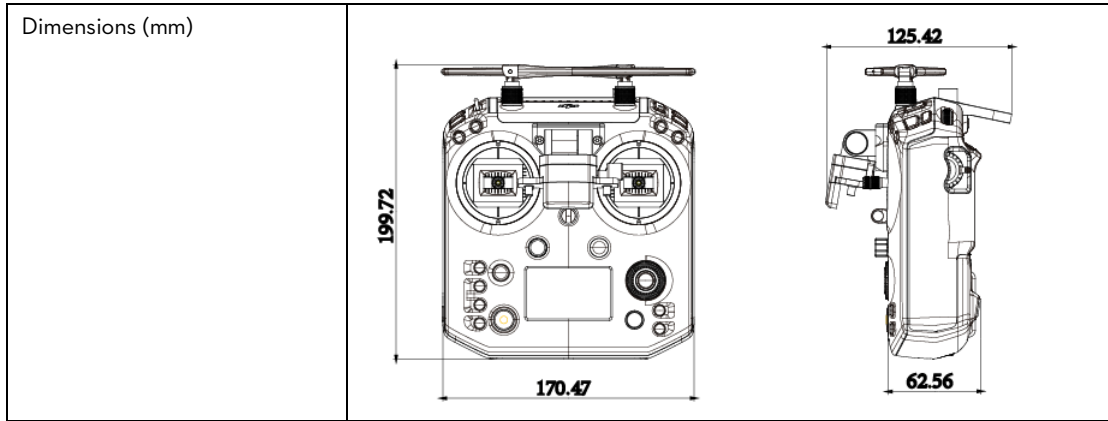

FCC Compliance Notice

This device complies with Part 15 of the FCC Rules. Operation is subject to the following two conditions: (1) This device may not cause harmful interference, and (2) This device must accept any interference received, including interference that may cause undesired operation. Any changes or modifications not expressly approved by the party responsible for compliance could void the user’s authority to operate the equipment.

This equipment has been tested and found to comply with the limits for a Class B digital device, pursuant to part 15 of the FCC Rules. These limits are designed to provide reasonable protection against harmful interference in a residential installation. This equipment generates, uses and can radiate radio frequency energy and, if not installed and used in accordance with the instructions, may cause harmful interference to radio communications. However, there is no guarantee that interference will not occur in a particular installation. If this equipment does cause harmful interference to radio or television reception, which can be determined by turning the equipment off and on, the user is encouraged to try to correct the interference by one or more of the following measures:

- Reorient or relocate the receiving antenna.
- Increase the separation between the equipment and receiver.
- Connect the equipment into an outlet on a circuit different from that to which the receiver is connected.
- Consult the dealer or an experienced radio/TV technician for help.

RF Exposure Information

The device complies with FCC radiation exposure limits set forth for an uncontrolled environment. For model GL800A, SAR tests are conducted using standard operating positions accepted by the FCC/IC with the device transmitting at its highest certified power level in all tested frequency bands, although the SAR is determined at the highest certified power level, the actual SAR level of the device while operating can be well below the maximum value. Before a new model is available for sale to the public, it must be tested and certified to the FCC/IC that it does not exceed the exposure limit established by the FCC/IC. Tests for each product are performed in positions and locations as required by the FCC/IC. For Handheld operation, this device has been tested and meets the FCC RF exposure guidelines when used with an accessory designated for this product.

ISED RSS Warning

This device complies with Industry Canada licence-exempt RSS standard (s). Operation is subject to the following two conditions: (1) this device may not cause interference, and (2) this device must accept any interference, including interference that may cause undesired operation of the device.

Le présent appareil est conforme aux CNR d'Industrie Canada applicables aux appareils radio exempts de licence.

L'exploitation est autorisée aux deux conditions suivantes:

- (1) l'appareil ne doit pas produire de brouillage, et
- (2) l'utilisateur de l'appareil doit accepter tout brouillage radioélectrique subi, même si le brouillage est susceptible d'en compromettre le fonctionnement.

ISED Radiation Exposure Statement:

This equipment complies with ISED RF radiation exposure limits set forth for an uncontrolled environment. This transmitter must not be co-located or operating in conjunction with any other antenna or transmitter.

Cet appareil est

conforme aux limites d'exposition de rayonnement RF ISED établies pour un environnement non contrôlé.

Cet émetteur ne doit pas être co-implanté ou fonctionner en conjonction avec toute autre antenne ou transmetteur.

Any Changes or modifications not expressly approved by the party responsible for compliance could void the user's authority to operate the equipment.