

QUAD BAND OTA
(Verizon)
User's Manual

Notice

Trademark

R-tron is a registered trademark of R-tron Inc.

Other products and company names mentioned here in this manual might be trademarks or trade names of their respective owners.

Copyright

Copyright © R-tron Inc. 2000-2010

All Rights Reserved

Any reproduction, distribution, or revisions of any or all portions of this manual is prohibited without written permission from R-tron Inc.

Notice

This document describes the specifications, installation, and operation of the OTA repeater.

Hardware and software mentioned in this document are subject to continuous development and improvement. Consequently, there may be minor discrepancies between the information in the document, performance, and design of the product.

Specifications, dimensions, and other statements mentioned in this document are subject to change without notice.

Questions or Comments

Address: R-tron America Inc. 6402 College Boulevard, Overland Park, KS 66211

Phone: + 1-913-344-9977, 1-888-31R-TRON

Fax: + 1-913-344-9988

E-mail: info@r-tronamerica.com

Website: www.rtronamerica.com

FCC Part 15.19

This device complies with part 15 of the FCC Rules. Operation is subject to The following two conditions: (1) This device may not cause harmful interference, and (2) this device must accept any interference received, including interference that may cause undesired operation.

FCC Part 15.21

Any changes or modifications (including the antennas) made to this device that are not expressly approved by the manufacturer may void the user's authority to operate the equipment.

RF Exposure Statement

FCC RF Radiation Exposure Statement: This equipment complies with FCC RF Radiation exposure limits set forth for an uncontrolled environment. This device and its antenna must not be co-located or operating in conjunction with any other antenna or transmitter.

Safety Precautions

Warning ⚠

Opening the OTA equipment could result in electric shock and may cause severe injury.

Warning ⚠

Connect the equipment frame ground to the building ground.

Warning ⚠

Operating the OTA with antennas in very close proximity facing each other could lead to severe damage to the repeater.

Caution ⚠

RF EXPOSURE INFORMATION

A minimum separation distance of 27 cm must be maintained between the user and the external antenna of the repeater to satisfy FCC RF exposure requirements. For more information about RF exposure, please visit the FCC website at www.fcc.gov

Caution ⚠

This equipment is for indoor use only and enables the communication wiring to communicate inside the building only.

Contents

Glossary	2
1. Introduction	3
2. Description.....	6
2.1. Main Unit	
Overview.....	
.....7	
2.2. Internal	
Configuration.....	
.....8	
2.2.1. Block	
diagram.....	
.....9	
2.2.2. AC-DC	
Adaptor.....	
.....10	
2.2.3. RFU(RF	
Unit).....	
.....11	
2.2.4. MCU(Main Control	
Unit).....	
.....12	
2.2.5.	
Duplexers.....	
.....13	
3. Hardware Installation	11
3.1. Check List of	
Items.....	
.....14	
3.2.	
Mounting.....	
.....15	
3.3.	
Grounding.....	
.....17	

3.4.		Cable
Connection.....		
.....18		
3.5.		Power
On.....		
.....18		
4. Operation		16
4.1.		System
Requirements.....		
.....21		
4.2.		Network
Setup.....		
.....21		
4.2.1.		Windows
XP.....		
.....21		
4.2.2.		Windows
2000.....		
.....23		
4.2.3.		Windows
Vista.....		
.....24		
4.3.	System	Log
in.....		
.....27		
4.4.		System
Setup.....		
.....27		
5. Troubleshooting		41
6. Specifications.....		48
7. Appendix.....		52

Glossary

The following is a list of abbreviations and terms used in this manual.

Abbreviation	Definition
AC	Alternating Current
ANT	Antenna
ATT	Attenuator / Attenuation
CDMA	Code Division Multiple Access
DC	Direct Current
DL	Downlink
GND	Grounding
GUI	Graphic User Interface
LED	Light Emitting Diode
PLL	Phase-locked loop
PSU	Power Supply Unit
RF	Radio Frequency
RSSI	Received Signal Strength Indication
TEMP	Temperature
UL	Uplink
VSWR	Voltage Standing Wave Ratio

ALC (Automatic Level Control)

ALC feature prevents the repeater from exceeding its maximum output power by reducing the gain automatically. ALC is used to adjust the gain to an appropriate level for a range of input signal levels.

ASD (Automatic Shutdown)

Automatic shut down protects the repeater from the oscillation or excessive input signal and eliminates any degradation to the network.

There are three parameters: **ASD Level**, **ASD Time**, and **ASD Iteration**.

If the output power reaches higher than the “**ASD LEVEL**”, the repeater will shut down for “**ASD TIME**” seconds and then it will turn the amp back on to measure the output power again. If this repeats at “Iteration” times, the repeater will shut down permanently.

1. Introduction

QUAD BAND OTA is used to fill out areas in QUAD BAND systems, such as base station fringe areas, business and industrial building, etc.

QUAD BAND OTA receives signals from a base station, amplifies and retransmits the signals

to the mobile stations. It also receives, amplifies and retransmits signals in the opposite direction. Both directions are served simultaneously with the following features:

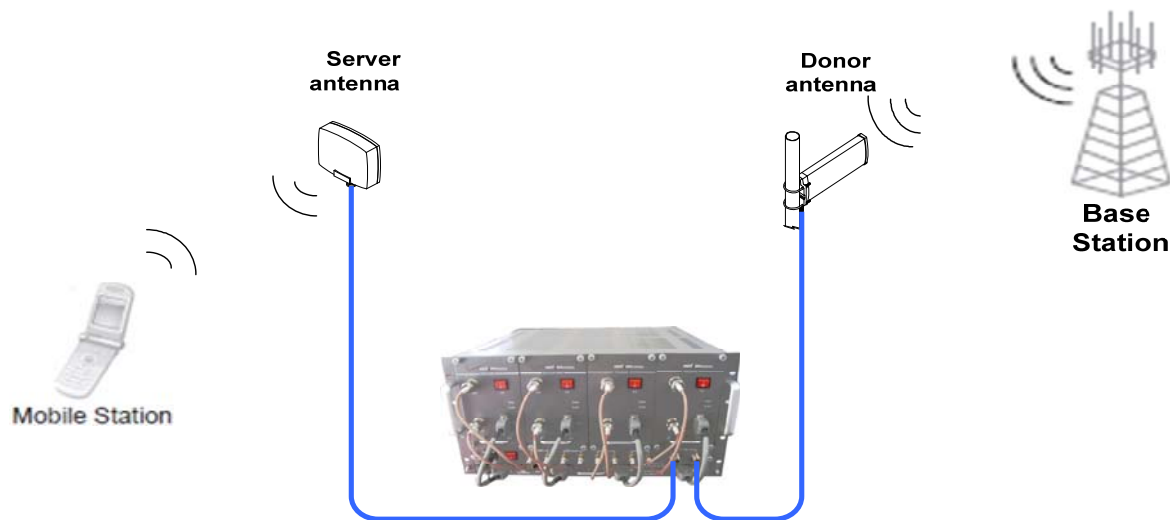

QUAD BAND OTA Key Features

- ◆ Composition(4 BDA by service band and combining Unit)
 - 700MHz Band BDA for LTE Service
 - Cellular Band BDA for EVDO/CDMA2000 Service (LTE Service is possible even the Firmware update only)
 - PCS Band BDA for EVDO/CDMA2000 Service
 - AWS Band BDA for EVDO/CDMA2000 Service (LTE Service is possible even the Firmware update only)
 - Combining Unit (MUX) is for input and output signal of each BDA to a single antenna.
- ◆ Design(Each BDA is possible to service selected channels by the user within a band.)
 - Possible to select any channel combination within a band caused by the Digital Filter.
 - Using the Digital Filter: High quality, out of band rejection, high performance
- ◆ Possible to combine the BDA according to Band.
 - Each BDA can be used as a stand alone unit(Use Privacy Ant Port)
 - Possible to combine the BDA(Dual, Tri, Quad-band)
- ◆ User friendly design.
 - Local monitoring and control through the Web GUI interface
 - Remote monitoring and control through the Remote Access and Control
 - Reports the status of connection as a function of SNMP regularly and reports an alarm if the event occurred.
- ◆ Protection function
 - Isolation and Oscillation Check
 - Isolation cancellation Function
 - Auto Gain Control
 - Auto Shutdown
- ◆ Service Coverage

- Possible to service by 25k square feet
- Use in office buildings, warehouses, underground parking lots, etc.

2. Description

2.1 Main Unit Overview

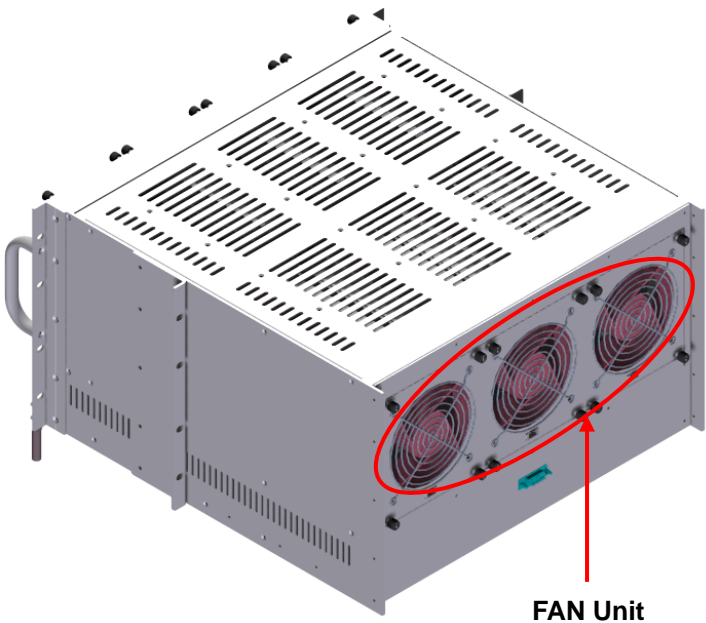
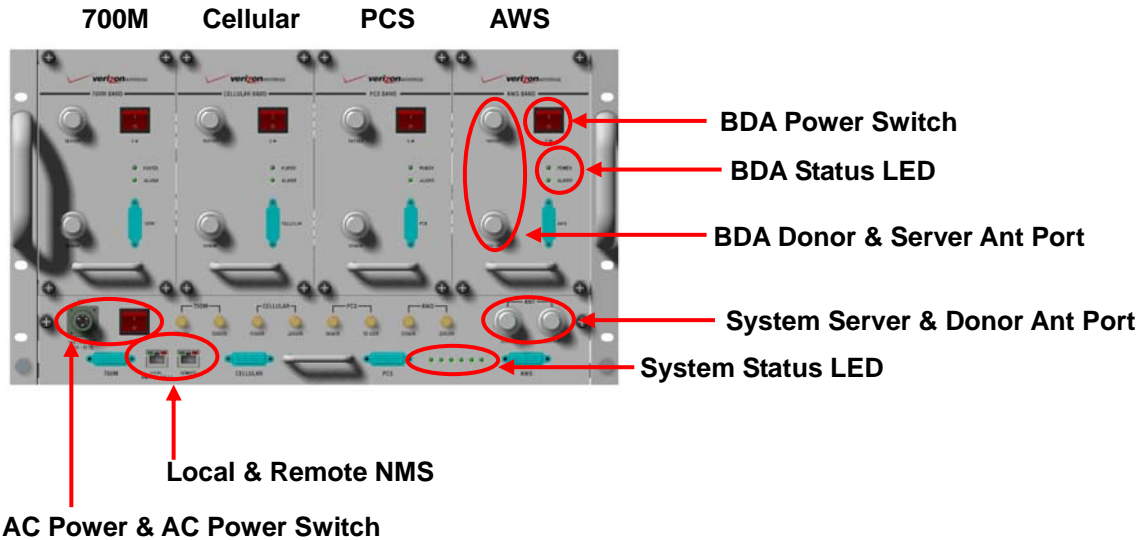

2.2 Internal Configuration

* BDA Unit

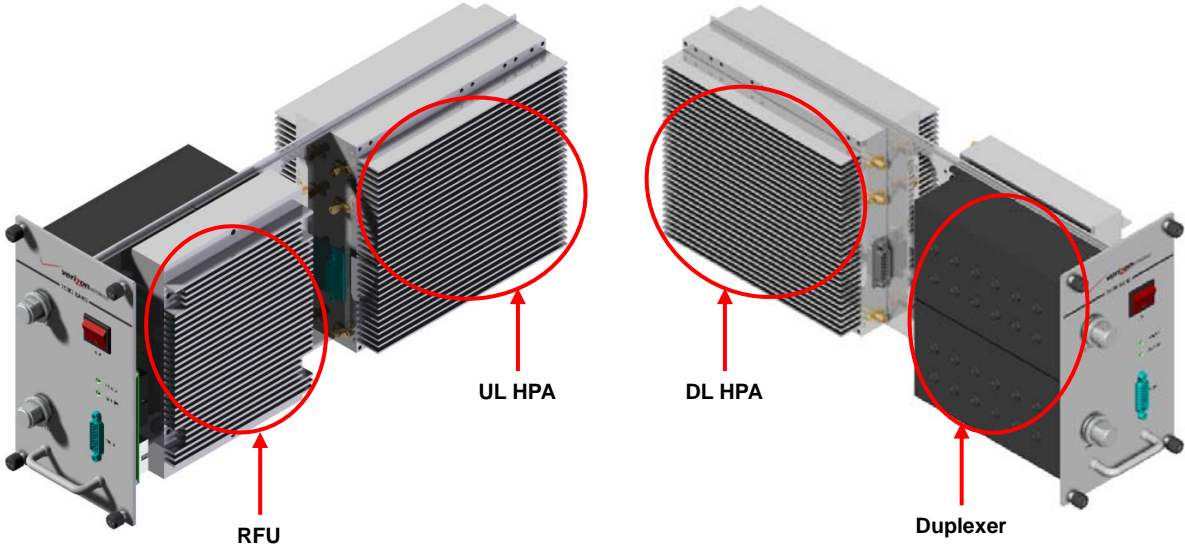

* MUX Unit

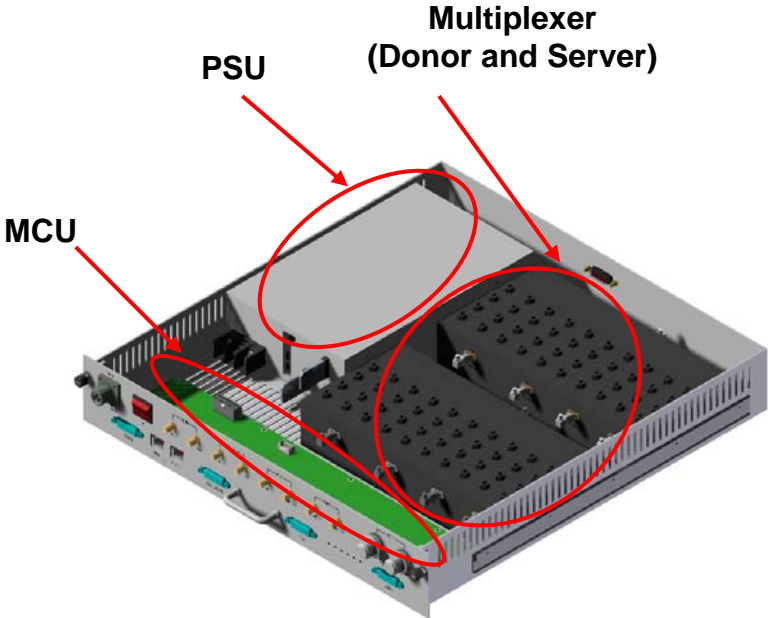

2.2.1 Block Diagram

The following diagram explains how the QUAD BAND OTA services signals.

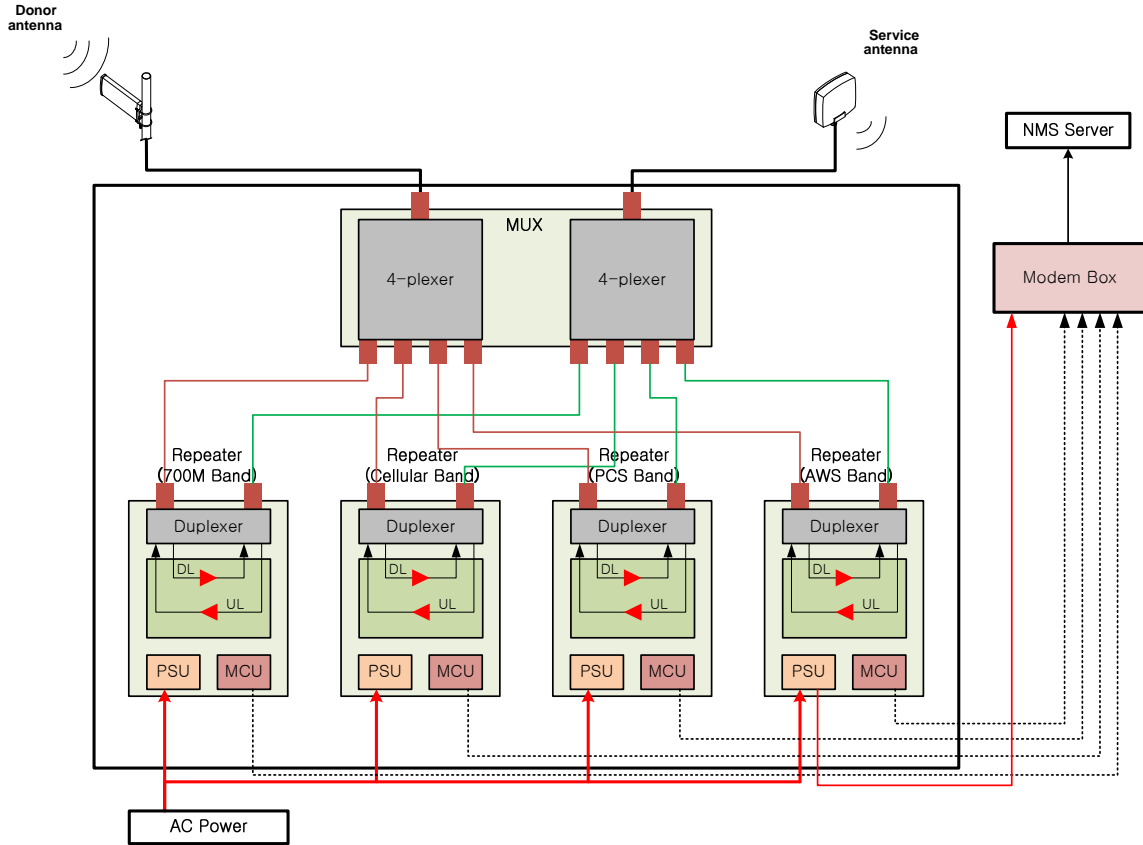

2.2.2 PSU

The AC-DC adaptor supplies a steady DC power to the CDMA MINI equipment by drawing power from the general in-wall AC outlets.



Specification

Item		Specification
Environmental	Operating Temp	-10°C~50°C (14°F~122°F)
	Humidity	20%~90%RH
	Cooling method	Convection.
Voltage		AC 85-264V
Current		+ 24V/27A (600W)
Frequency		50/60(47-63)

2.2.3 RFU (RF Unit)

The RFU (RF Unit) is a bi-directional amplifier that sharply filters out unwanted noise.

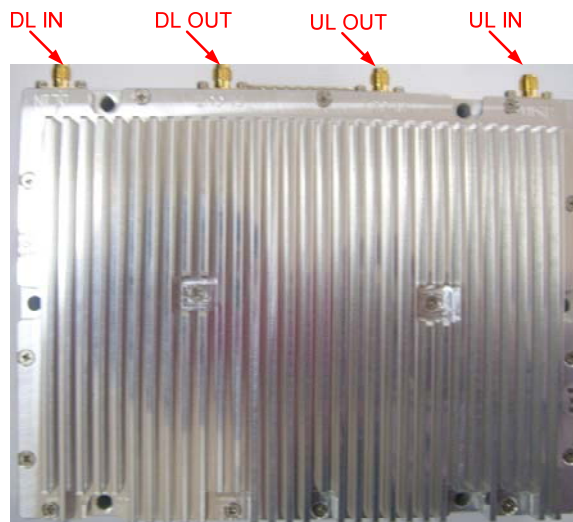

2.2.4 HPA (High Power Amplifier)

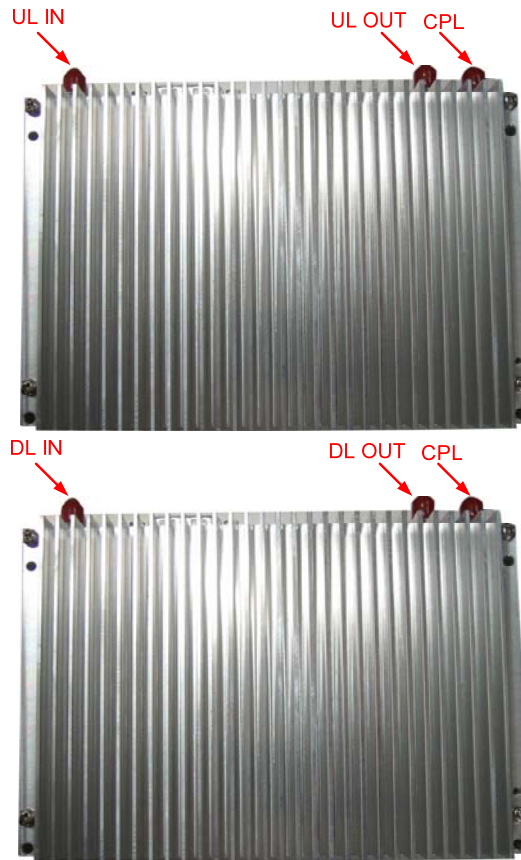

2.2.5 MCU (Main Control Unit)

The MCU (Main Control Unit) is the control unit of a QUAD BAND OTA. It controls and monitors operational parameters. It is also responsible for generating alarms, keeping event logs and performing many other functions of the QUAD BAND OTA.

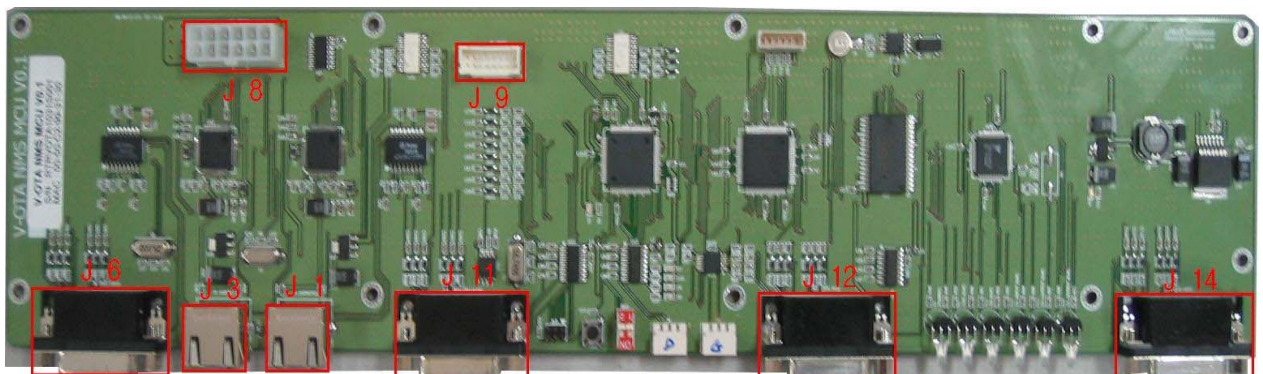

2.2.6 Duplexer

A duplexer is a device that combines two or more signals onto a common channel or medium to increase its transmission efficiency.



2.2.7 Multiplexer

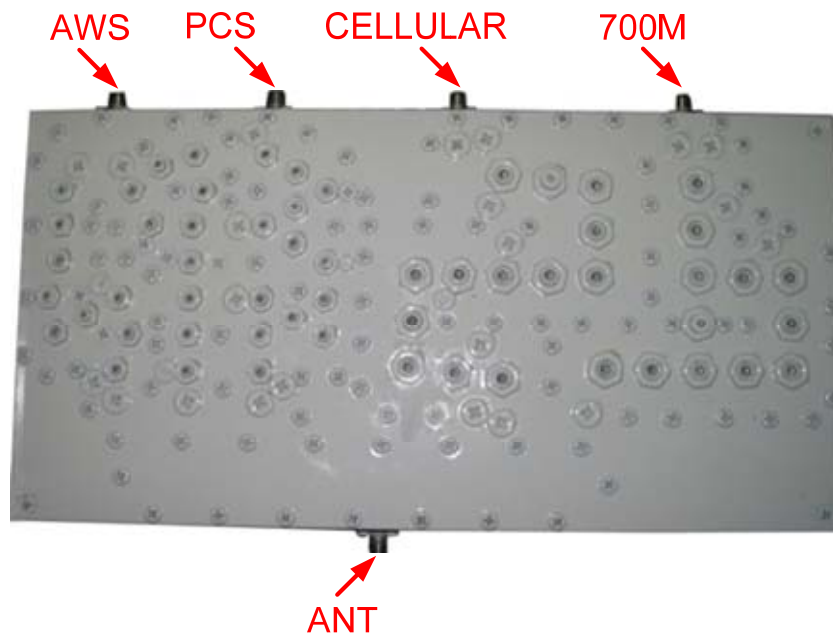

3. Hardware Installation

The installation procedure is as follows:

- Check List of Items

- Mounting
- Grounding
- RF Cable Connection
- Power On

Index	Items	Quantity
1	RF Module	4
2	Shelf	1
3	MUX	1
4	AC Cable	1
5	RF Cable	8
6	LAN Cable	1
7	DATA Cable	4
8	Bolt	4
9	Quick Manual	1
10	User's Manual	1

Item Figure



RF Module

Shelf

MUX

AC Cable

RF Cable



LAN Cable



DATA Cable



Bolt



Quick Manual



User's Manual

3.2 Mounting

Step 1 : Find a location for the Repeater to be installed on a 19 inch rack.



Step 2 : Insert the Repeater on the shelf.



Step 3 : Fix the Repeater shelf using the provided screws.

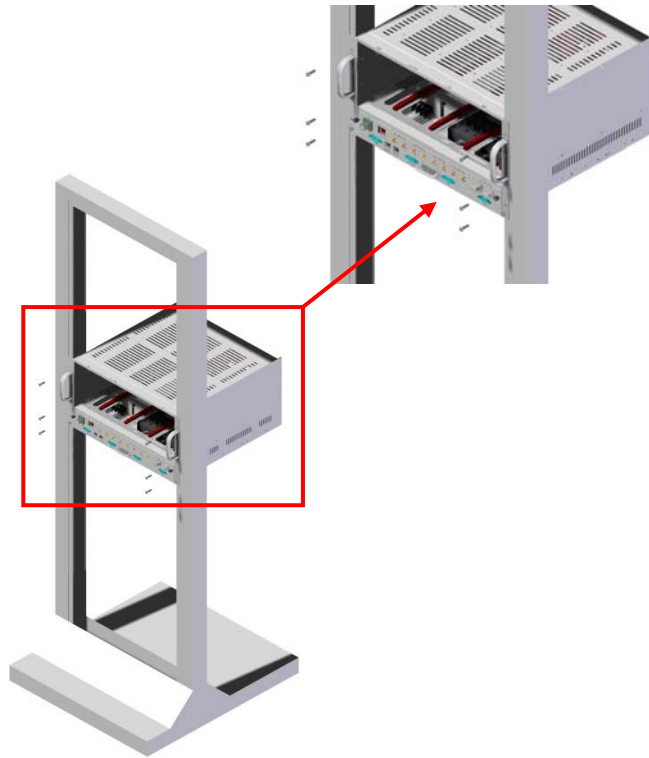

Step 4 : Insert the Combine Unit(MUX) and Fix it.

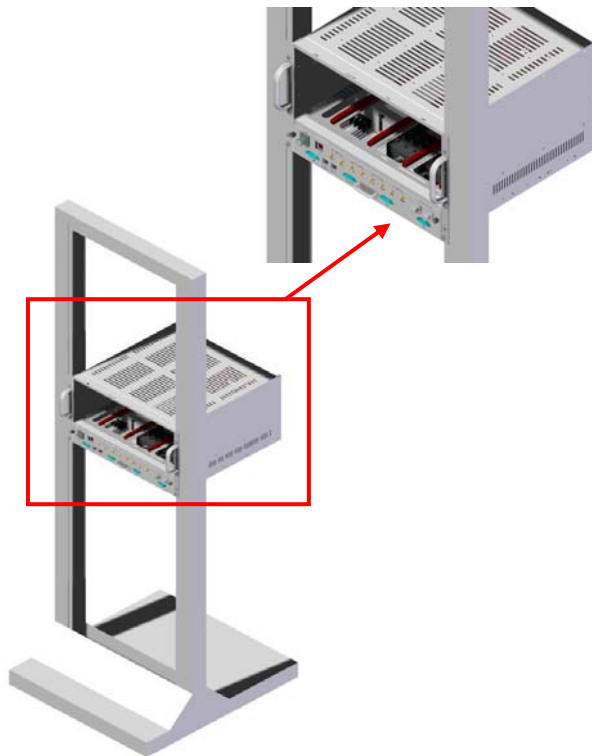



Step 5 : Insert each BDA for the Repeater and secure it.

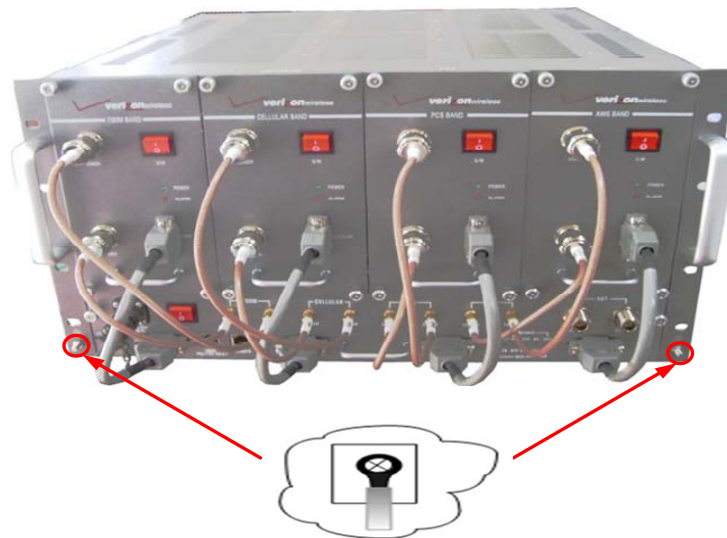

3.3 Grounding

A rod on the left side is intended for a building ground. Connect the ground cable to the rod.



 **Warning** Dangerously high voltages may occur and damage the equipment if the equipment is not grounded properly.

3.4 RF Cable Connection

Step 1 : Connect a cable from the donor antenna to the Donor Antenna Port.

Step 2 : Connect a cable from a repeater's service antenna to the Server Antenna Port.



DO NOT connect or disconnect the coaxial cable while the power is on.

Note

Enough isolation?

Antenna isolation = Path loss between the server antenna port and the donor antenna port

Antenna isolation \geq Repeater max. gain +15dB

If antenna isolation < Repeater max. gain +15dB \rightarrow System oscillation or Low gain

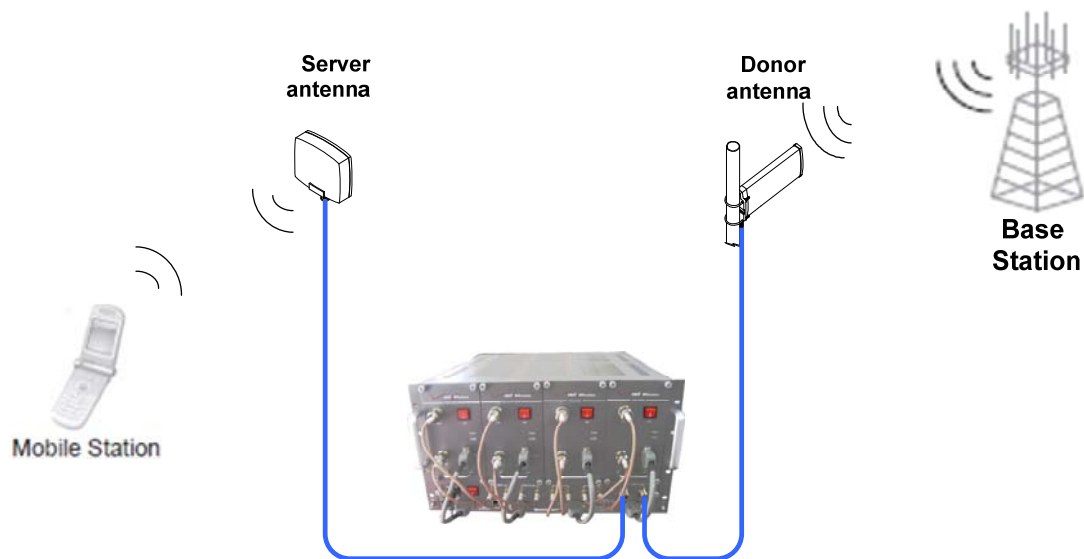

3.5 Power On

Step 1 : Connect the power cord.

Step 2 : Plug the power cord into a wall outlet.

Step 3 : Check if the green LED at the Top turns on.



4. Operation

4.1 System Requirements

QUAD BAND OTA operates on a customer provided PC based platform with the following system requirements:

- Windows® 2000, Windows® XP or Windows® Vista
- Internet Explorer 6.0(Recommended) or higher
- 128 MB RAM or higher
- Pentium III processor or higher
- RJ-45 jack required

4.2 Network Setup

4.2.1 Windows XP

Step 1 : Click the **Start** button and select **My Network Places**.



Step 2 : Click **View network connections**.

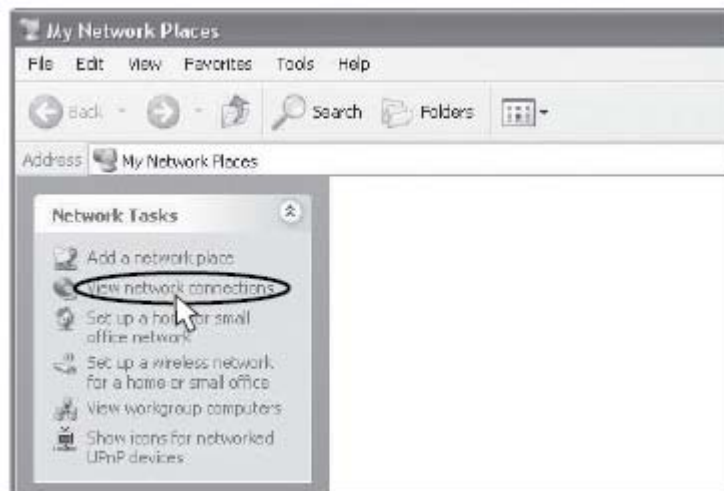

Step 3 : Right-click **Local Area Connection** to see a shortcut menu and click **Properties**.



Step 4 : Select **Internet Protocol (TCP/IP)** and click **Properties**.

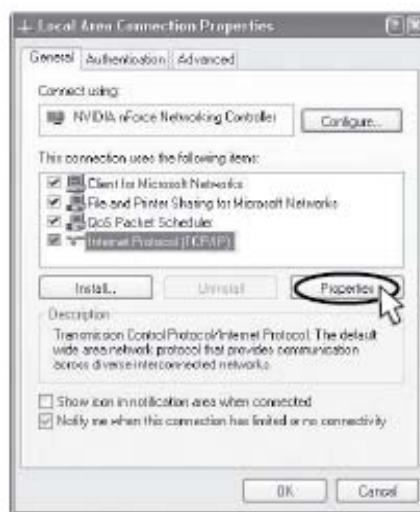

Step 5 : Check **Obtain an IP address automatically** and click **OK**.



Step 6 : Close all windows.

4.2.2 Windows 2000

Step 1 : Click the **Start** button, point to **Settings**, and then click **Network and Dial-up Connections**.

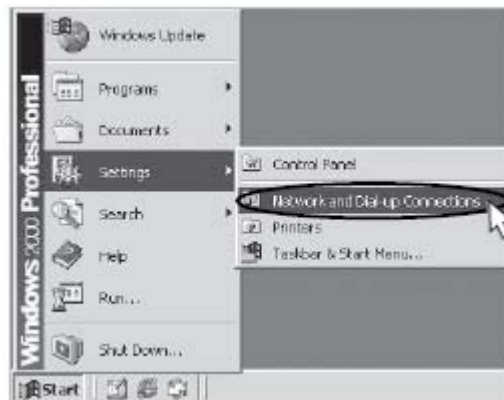

Step 2 : Right-click **Local Area Connection** to see the shortcut menu and click **Properties**.

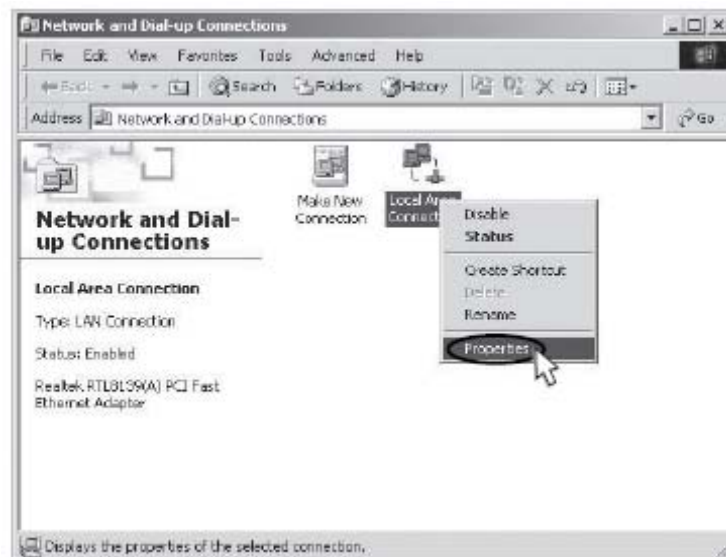

Step 3 : Select **Internet Protocol (TCP/IP)** and click **Properties**.



Step 4 : Check **Obtain an IP address automatically** and click **OK**.



Step 5 : Close all windows.

4.2.3 Windows Vista

Step 1 : Click the **Start** button and select **Control Panel**.



Step 2 : Click **Network and Internet**.

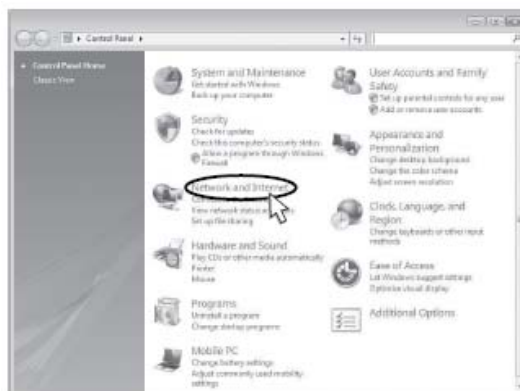

Step 3 : Click **Network and Sharing Center**.

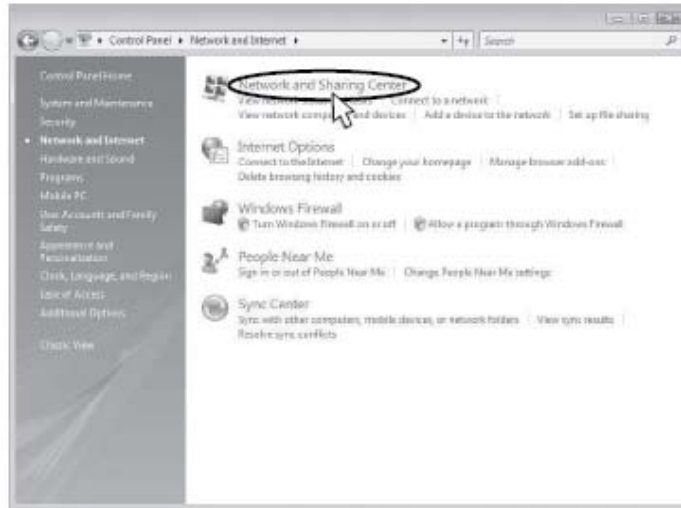

Step 4 : Click **View status of Local Area Connection**.

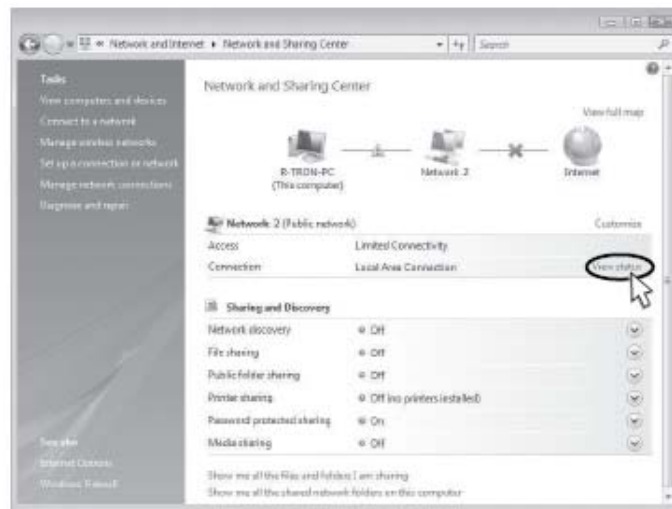

Step 5 : Click **Properties** and a caution pop-up window will appear. Click **OK**.

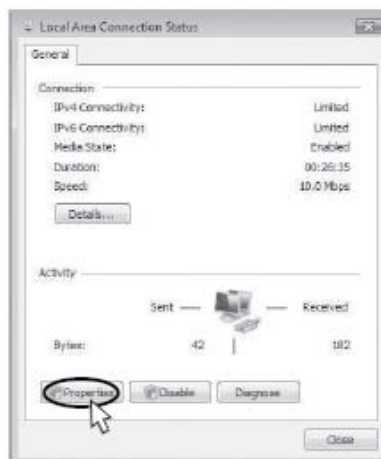

Step 6 : Select **Internet Protocol Version 4 (TCP/IPv4)** and click **Properties**.

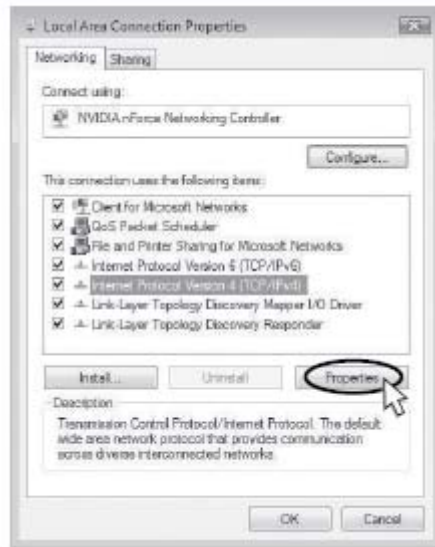

Step 7 : Check **Obtain an IP address automatically** and click **OK**.



Step 8 : Close all windows.

4.3 System Login

Open your Web browser and type “192.168.0.1” into the URL address box. Then press the Enter key.



4.4 System Setup

4.4.1 Clock

The clock will automatically be set to your PC time when you click the APPLY



4.4.2 Network

When you click on the Network, the Web GUI screen is automatically updated every 5 seconds.

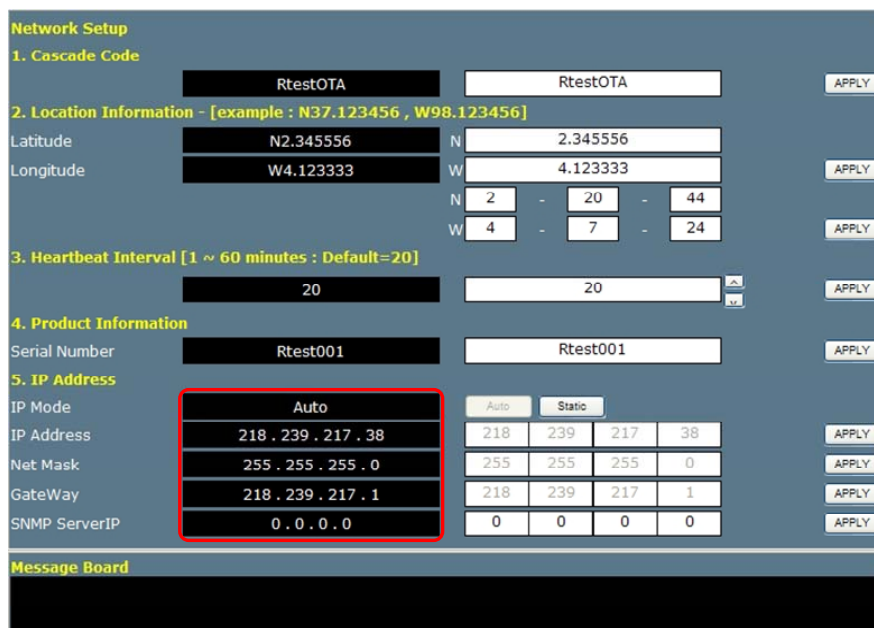

4.4.3 Control

Quad OTA Repeater does not need to be logged-In. The user can control the repeater directly with the WEB GUI.

Case1. 700M BAND

Network Information		System Information	
Cascade Code[Mandatory]	RT VzW OTA	Model Number	RVW-700-30-DC
Latitude/Longitude	12.345678/ 34.123456	Maximum Output Power/Gain	30dBm / 87dB
Serial Number	Test001	Software Version	11.5.5

Path Control		Factory Set & Recommend Max Gain	
DL Path	ON	Factory Default	Enable
UL Path	ON	Recommend Max Gain	104.0 dB

Power Status		Band Setup	
Input Power	Downlink: -56.9 dBm, Uplink: -100.5 dBm	Band Select	
Output Power	30.1 dBm, -13.5 dBm	C1, C, C2	

Power Control		Alarms and Current Status	
ALC [Automatic Level Control]		Tamper detected	Communication failure
DL ALC Level	30 dBm, 30 [0~ 30]	Field replaceable fail	Synthesizer Failure
UL Gain Offset	0 dB, 0 [- 5~ 5]	Hardware Failure	Software Failure
ALC Status	ON	UL Oscillation Detected	DL interferer power exceeded
Manual Gain Control		UL Out-of-band emissions	DL Spurious emission
DL Gain	87 dB, 87 [67~ 87]	Reset alarm	Normal Range
UL Gain	87 dB, 87 [67~ 87]	UL power at coverage high	< -30 dBm
ASD [Automatic Shut Down]		DL donor power Normal	-90~-30 dBm
ASD Level	33 dB, 33 [0~ 33]	DL VSWR	< 3
Status	ON	Power supply out of range	24, 20~28 V
Sleep Mode		Over temperature	81.5, < 176 F
Status	ON	DL Low isolation	119, > 103 dB
		Manual Shutdown	Normal

Message Board	

Solution 1. Manual Gain Setting

Step 1A Select the repeater.

Select	Lock
<input checked="" type="checkbox"/>	<input type="checkbox"/>
<input type="checkbox"/>	<input type="checkbox"/>
<input type="checkbox"/>	<input type="checkbox"/>
<input type="checkbox"/>	<input type="checkbox"/>

Step 2A Select the channel band of the area in use.

Band Setup		
C1	C	C2

Step 3A Turn off the DL and UL Amplifier



Step 4A ALC must be turned off
(700M, PCS, AWS : 30dBm / CELLUAR : 25dBm)



Step 5A The Setup is the Available Maximum Gain which defines as the maximum gain. Change the DL and UL Gain. Turn on the DL and UL Amplifier

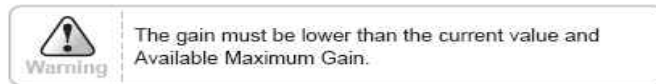

Result 1 DL and UL gain are fixed and the output power depends on the input power

Result 2 Constant Maximum DL Output Power 30dBm

If the DL Input Power ≥ -57 dBm



Solution2 . ALC Gain Setting.

Step 1A ~ Step 3A

Step 4B ALC must be turned on.

(700M, PCS, AWS : 30dBm / CELLUAR : 25dBm)



Step 5B Setup is the Available Maximum Gain which is defined as the maximum gain. Change the DL and UL Gain. Turn on the DL and UL Amplifier

The screenshot displays a configuration interface with several sections:

- Path Control:** DL Path and UL Path are both set to ON.
- Power Status:** A table showing power levels for Downlink and Uplink. The Downlink Input Power is -56.9 dBm and Output Power is 30.1 dBm. The Uplink Input Power is -100.5 dBm and Output Power is -13.5 dBm. A red box highlights the Downlink Input Power value.
- Power Control - ALC [Automatic Level Control]:** DL ALC Level is 30 dBm, UL Gain Offset is 0 dB, and ALC Status is ON. A red box highlights the ALC Status.
- Manual Gain Control:** DL Gain and UL Gain are both set to 87 dB. A red box highlights these values.
- ASD [Automatic Shut Down]:** ASD Level is 33 dB and Status is ON.
- Sleep Mode:** Status is ON.

Section	Parameter	Value
Path Control	DL Path	ON
	UL Path	ON
Power Status	Downlink Input Power	-56.9 dBm
	Uplink Input Power	-100.5 dBm
	Downlink Output Power	30.1 dBm
	Uplink Output Power	-13.5 dBm
Power Control - ALC	DL ALC Level	30 dBm
	UL Gain Offset	0 dB
	ALC Status	ON
	DL Gain	87 dB
Manual Gain Control	UL Gain	87 dB
	ASD Level	33 dB
ASD [Automatic Shut Down]	Status	ON
	Sleep Mode Status	ON

Case2. CELLULAR BAND

Network Information Cascade Code[Mandatory] RT VzW OTA Latitude/Longitude 12.345678/34.123456 Serial Number Test001		System Information Model Number RVW-CEL-27-DC Maximum Output Power/Gain 27dBm / 90dB Software Version 11.5.5	
Path Control DL Path <input checked="" type="checkbox"/> ON <input type="checkbox"/> OFF UL Path <input checked="" type="checkbox"/> ON <input type="checkbox"/> OFF		Factory Set & Recommend Max Gain Factory Default Exclude Recommend Max Gain 93.7 dB	
Power Status Input Power Downlink -62.6 dBm Uplink -108.2 dBm [ELA] Output Power 27.4 dBm -18.2 dBm		Band Setup Band Select <input checked="" type="checkbox"/> A1 <input type="checkbox"/> B1 <input type="checkbox"/> A2 <input type="checkbox"/> B2	
Power Control ALC [Automatic Level Control] DL ALC Level 27 dBm 27 [0~ 27] APPLY UL Gain Offset 0 dB 0 [- 5~ 5] APPLY ALC Status <input checked="" type="checkbox"/> ON <input type="checkbox"/> OFF		Alarms and Current Status Tamper detected <input checked="" type="checkbox"/> Communication failure <input checked="" type="checkbox"/> Field replaceable fail <input checked="" type="checkbox"/> Synthesizer Failure <input checked="" type="checkbox"/> Hardware Failure <input checked="" type="checkbox"/> Software Failure <input checked="" type="checkbox"/> UL Oscillation Detected <input checked="" type="checkbox"/> DL interferer power exceeded <input checked="" type="checkbox"/> UL Out-of-band emissions <input checked="" type="checkbox"/> DL Spurious emission <input checked="" type="checkbox"/> Reset alarm <input checked="" type="checkbox"/> Normal Range UL power at coverage high <input checked="" type="checkbox"/> < -30 dBm DL donor power Normal <input checked="" type="checkbox"/> -90~-30 dBm DL VSWR <input checked="" type="checkbox"/> < 3 Power supply out of range <input checked="" type="checkbox"/> 24 20~28 V Over temperature <input checked="" type="checkbox"/> 69.1 < 176 F DL Low isolation <input checked="" type="checkbox"/> 108.7 > 105 dB Manual Shutdown <input checked="" type="checkbox"/> Normal	
Manual Gain Control DL Gain 90 dB 90 [60~ 90] APPLY UL Gain 90 dB 90 [60~ 90] APPLY			
ASD [Automatic Shut Down] ASD Level 30 dB 30 [0~ 30] APPLY Status <input checked="" type="checkbox"/> ON <input type="checkbox"/> OFF			
Sleep Mode Status <input checked="" type="checkbox"/> ON <input type="checkbox"/> OFF		Message Board	

Solution 1. Manual Gain Setting Gain

Step 1A Select the repeater.

[Home]
 [Network]
 [Control]
 Select Lock
 700M Band
 Cellular Band
 PCS Band
 AWS Band

Step 2A Select the channel band of the area in use.

Band Setup
 A1 B1 A2 B2

Step 3A Turn off the DL and UL Amplifier



Step 4A ALC must be turned off
(700M, PCS, AWS : 30dBm / CELLUAR : 25dBm)



Step 5A Setup is the Available Maximum Gain which is defined as the maximum gain. Change the DL and UL Gain. Turn on the DL and UL Amplifier

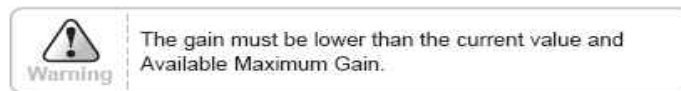

Result 1 DL and UL gain are fixed and the output power depends on the input power

Result 2 Constant Maximum DL Output Power 25dBm

If the DL Input Power \geq -63dBm

Path Control

DL Path ON ON OFF

UL Path ON ON OFF

Power Status

Input Power	Downlink	-62.6 dBm	Uplink	-108.4 dBm	[<input type="button" value="↔"/>]
Output Power		27.4 dBm		-18.4 dBm	

Power Control

ALC [Automatic Level Control]

DL ALC Level dBm [0~ 27]

UL Gain Offset dB [- 5~ 5]

ALC Status OFF ON OFF

Manual Gain Control

DL Gain dB [60~ 90]

UL Gain dB [60~ 90]

ASD [Automatic Shut Down]

ASD Level dB [0~ 30]

Status ON ON OFF

Sleep Mode

Status ON ON OFF

Solution2 . ALC Gain Setting.

Step 1A ~ Step 3A

Step 4B ALC must be turned on.

(700M, PCS, AWS : 30dBm / CELLUAR : 25dBm)



Power Control
ALC [Automatic Level Control]

DL ALC Level	27 dBm	27	[0~ 27]	APPLY
UL Gain Offset	0 dB	0	[- 5~ 5]	APPLY
ALC Status	OFF	ON	OFF	

Step 5B The Setup is the Available Maximum Gain which is defined as the maximum gain. Change the DL and UL Gain. Turn on the DL and UL Amplifier



Path Control

DL Path	ON	ON	OFF
UL Path	ON	ON	OFF

Power Status

Input Power	Downlink: -62.6 dBm	Uplink: -108.2 dBm	[3.6]
Output Power	27.4 dBm	-18.2 dBm	

Power Control
ALC [Automatic Level Control]

DL ALC Level	27 dBm	27	[0~ 27]	APPLY
UL Gain Offset	0 dB	0	[- 5~ 5]	APPLY
ALC Status	ON	ON	OFF	

Manual Gain Control

DL Gain	90 dB	90	[60~ 90]	APPLY
UL Gain	90 dB	90	[60~ 90]	APPLY

ASD [Automatic Shut Down]

ASD Level	30 dB	30	[0~ 30]	APPLY
Status	ON	ON	OFF	

Sleep Mode

Status	ON	ON	OFF	
--------	----	----	-----	--

Case3. PCS BAND

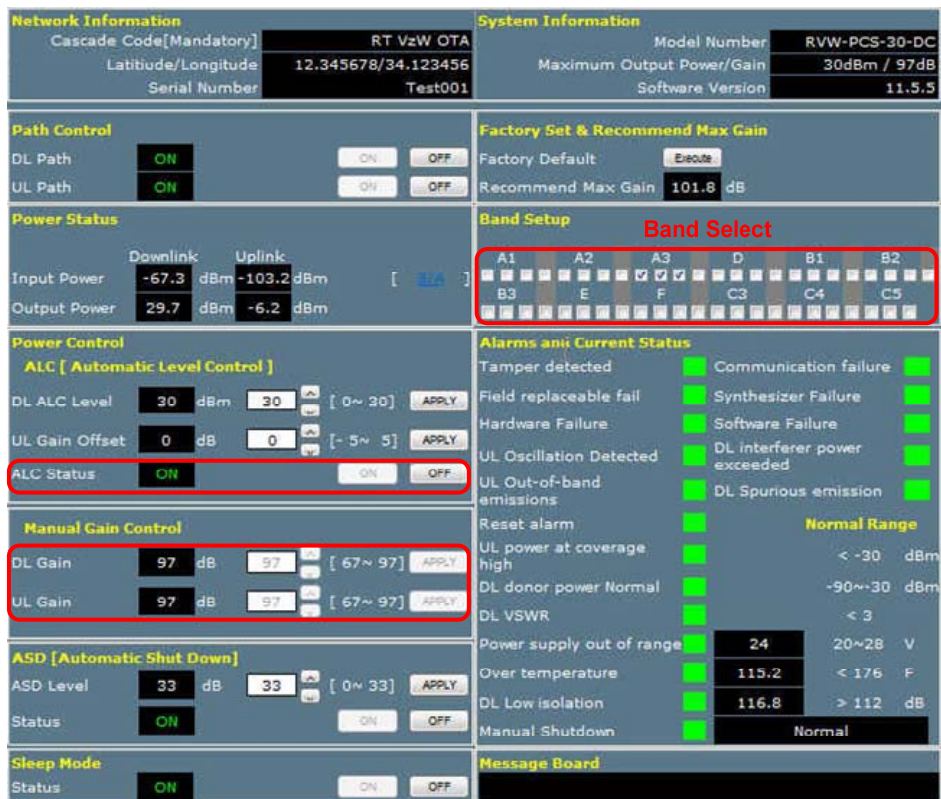

Solution 1. Manual Gain Setting Gain

Step 1A Select the repeater.



Step 2A Select the channel band of the area is use.

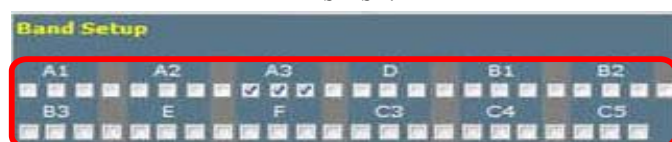

Step 3A Turn off the DL and UL Amplifier



Step 4A ALC must be turned off
 (700M, PCS, AWS : 30dBm / CELLUAR : 25dBm)



Step 5A The Setup is the Available Maximum Gain which is defined as the maximum gain. Change the DL and UL Gain. Turn on the DL and UL Amplifier

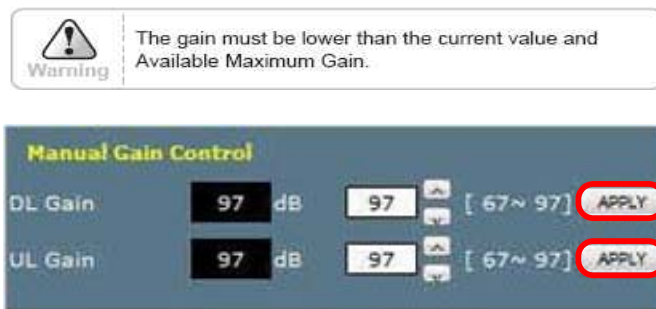

Result 1 DL and UL gain are fixed and the output power depends on the input power
 Result 2 Constant Maximum DL Output Power 30dBm
 If the DL Input Power \geq -67dBm



Solution2 . ALC Gain Setting.

Step 1A ~ Step 3A

Step 4B ALC must be turned on.

(700M, PCS, AWS : 30dBm / CELLUAR : 25dBm)



Step 5B The Setup is the Available Maximum Gain which is defined as the maximum gain. Change the DL and UL Gain. Turn on the DL and UL Amplifier



Case4. AWS BAND

The screenshot displays the configuration interface for an AWS band. Key sections include:

- Network Information:** Cascade Code [Mandatory] RT VzW OTA, Latitude/Longitude 12.345678/34.123456, Serial Number Test001.
- System Information:** Model Number RVW-AWS-30-DC, Maximum Output Power/Gain 30dBm / 97dB, Software Version 11.5.3.
- Path Control:** DL Path ON, UL Path ON.
- Power Status:** Downlink Input Power -66.9 dBm, Uplink Input Power -101.3 dBm, Downlink Output Power 30.1 dBm, Uplink Output Power -4.3 dBm.
- Band Setup:** A red box highlights the 'Band Select' section, showing a grid of channel options labeled A through F.
- Power Control:** ALC [Automatic Level Control] is ON. DL ALC Level is 30 dBm, UL Gain Offset is 0 dB. A red box highlights the ALC Status and gain settings.
- Manual Gain Control:** DL Gain is 97 dB, UL Gain is 97 dB. A red box highlights these gain settings.
- ASD [Automatic Shut Down]:** ASD Level is 33 dB, Status is ON.
- Sleep Mode:** Status is ON.
- Alarms and Current Status:** Lists various alarms such as Tamper detected, Field replaceable fail, Hardware Failure, etc., with their current status (ON/OFF).

Solution 1. Manual Gain Setting Gain

Step 1A Select the repeater.

The screenshot shows a menu for selecting the repeater type. The options are:

- 700M Band
- Celluar Band
- PCS Band
- AWS Band** (highlighted with a red box)

Step 2A Select the channel band of the area in use.

The screenshot shows the 'Band Setup' section with a grid of channel options labeled A through F. A red box highlights the grid, indicating the selection of a channel band.

Step 3A Turn off the DL and UL Amplifier



Step 4A ALC must be turned off
(700M, PCS, AWS : 30dBm / CELLUAR : 25dBm)



Step 5A The Setup is the Available Maximum Gain which is defined as the maximum gain. Change the DL and UL Gain. Turn on the DL and UL Amplifier

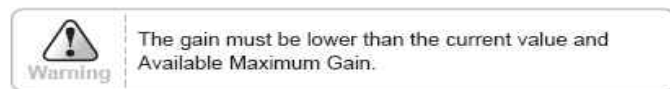

Result 1 DL and UL gain are fixed and the output power depends on the input power

Result 2 Constant Maximum DL Output Power 30dBm

If the DL Input Power \geq -67dBm



Solution2 . ALC Gain Setting.

Step 1A ~ Step 3A

Step 4B ALC must be turned on.

(700M, PCS, AWS : 30dBm / CELLUAR : 25dBm)



Step 5B The Setup is the Available Maximum Gain which is defined as the maximum gain. Change the DL and UL Gain. Turn on the DL and UL Amplifier

Path Control

DL Path ON ON OFF

UL Path ON ON OFF

Power Status

	Downlink	Uplink
Input Power	-66.9 dBm	-101.3 dBm
Output Power	30.1 dBm	-4.3 dBm

Power Control

ALC [Automatic Level Control]

DL ALC Level dBm [0~ 30]

UL Gain Offset dB [- 5~ 5]

ALC Status ON ON OFF

Manual Gain Control

DL Gain dB [67~ 97]

UL Gain dB [67~ 97]

ASD [Automatic Shut Down]

ASD Level dB [0~ 33]

Status ON ON OFF

Sleep Mode

Status ON ON OFF

Solution3. Alarms

Alarms and Current Status

Tamper detected	<input checked="" type="checkbox"/>	Communication failure	<input checked="" type="checkbox"/>
Field replaceable fail	<input checked="" type="checkbox"/>	Synthesizer Failure	<input checked="" type="checkbox"/>
Hardware Failure	<input checked="" type="checkbox"/>	Software Failure	<input checked="" type="checkbox"/>
UL Oscillation Detected	<input checked="" type="checkbox"/>	DL Interferer power exceeded	<input checked="" type="checkbox"/>
UL Out-of-band emissions	<input checked="" type="checkbox"/>	DL Spurious emission	<input checked="" type="checkbox"/>
Reset alarm	<input checked="" type="checkbox"/>		
UL power at coverage high	<input checked="" type="checkbox"/>	Normal Range	
DL donor power Normal	<input checked="" type="checkbox"/>		< -30 dBm
DL VSWR	<input checked="" type="checkbox"/>		-90~-30 dBm
Power supply out of range	<input checked="" type="checkbox"/>		< 3
Over temperature	<input checked="" type="checkbox"/>	24	20~28 V
DL Low isolation	<input checked="" type="checkbox"/>	81.5	< 176 F
Manual Shutdown	<input checked="" type="checkbox"/>	119	> 103 dB
			Normal

- **Alarm** : If an alarm occurs, the alarm LED on the repeater will turn on. Please refer to the troubleshooting section of this manual.
- It is recommended to NOT change any of the values in the alarm range.

Solution4. ALC



- **Automatic Level Control:** Type under 30 and then click **APPLY** and **ON**.
 [Example at the 700M BAND]
 For a repeater with 30dBm maximum output power, 87dB maximum gain/ 30dB gain Control range, → If the signal -57dBm and the ALC is set as 23dBm, the gain will be 80dB to adjust to the output power.
 If the input signal is -50dBm, the output power will be 30dBm by the Limitation of the maximum gain even though the ALC is set as 30dBm

Solution5. ASD

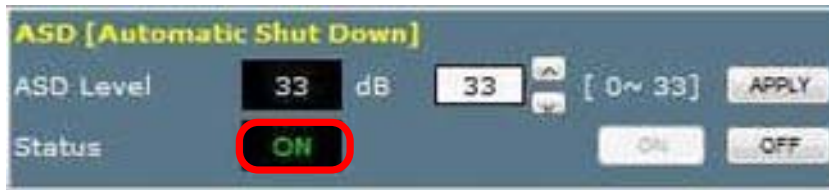

(700, PCS, AWS)



(CELLULAR)

- **Automatic Shutdown:** Type the desired value for the ASD Level and then Click **APPLY** and **ON**.
[Example at the PCS BAND]
For a repeater with 30dBm Maximum Output Power, 97dB Maximum Gain/ 30dB gain control range, assuming **ASD Level: 33dBm, ASD Time, ASD Count** are already fixed at 3seconds, 10times.
If the composite output power is 33dBm(ASD Level) and higher, the repeater will shutdown for 3seconds(ASD Time). If the shutdown occurs 10times(ASD Count), the 11th shutdown will be permanent.
And repeater runs Easy setup automatically. After that, it is activated with the re-calculated antenna isolation value.

5. Troubleshooting

Before contacting your service dealer, please make sure you refer to the following guide. If the QUAD BAND OTA does not work normally after completing the following troubleshooting tips, please contact your local dealer or service center.

Case 1) LED indicator is not normal

Problem	Check Point	Solution
Critical	POR LED is red	Power supply out of range - Confirm AC 85 - 264V common use power and power cable.
	TD LED is red	Tamper detected - Check the status of the BDA equipment.
	BTF LED is red	Built-in test failure - Check which alarm occurred through the WEB GUI Alarm status. - UL Out-of-band emissions, DL Spurious emissions, DL Interferer power exceeded, DL Low isolation, Over temperature - Case 2) Problem solving by Alarm indicator.
	RMF LED is red	Replaceable module failure - select BDA's alarm LED is red - reset BDA's power - BDA's alarm LED is still red, Contact Technical Support
	OSC LED is red	Oscillation detected - Check Donor/Server ant. Isolation and if the value of Gain is less than +5dB, adjust the location of antenna to secure isolation.
	SD LED is red	Shutdown - Check the S/D reason using WEB GUI. - If the Manual HPA is Off, turn it back On. - If Overpower S/D occurred and Manual Gain is setting up, control the Gain setting. - If Overpower S/D occurred and the ALC is On, set up the ALC Level 1 to 3dB low. Fix the ALC Level if it is normal after monitoring for so long. (It can be possible to occur if Input Power change is extreme.)
Minor	DCF LED is orange	Donor Circuitry failure - DL Donor Power too high - After checking the DL input Power, adjust the location of the antenna or install the external antenna to the permitted range if it is over the permitted level
	DPL LED is orange	Donor power too low - DL Donor Power too low - If the DL input Power is too low, adjust the location of the antenna to be at a high input value.
	CCF LED is orange	Coverage Circuitry failure - UL Power at coverage high, DL VSWR - If the DPL LED is normal but the CCF LED is not normal, reduce the UL Gain. (If ALC is On, it can reduce the UL Gain by controlling the Gain Offset.)

	RE LED is orange	Reset engaged - Reset alarm - Do not control the Repeater during reset.
	AGC LED is orange	AGC active - AGC On - It means that ALC is On and operating well not the Alarm.

Case 2) When Alarm indicator

Problem	Check Point	Solution
General	Tamper detected	Install the BDA at the System and set up the Lock using the WEB GUI. Alarm occurred when the BDA unequipped without cancellation of Lock for setting.
	Power supply out of range	- Check if the input power is AC85-264V and if it is normal, Contact Technical Support.
	Communication failure	Check the status of the Data Cable connection. If communication failure occurred at every connected BDA, Reset the MCU. If communication failure occurred at a particular BDA, Reset BDA for the occurred failure.
	Field replaceable module failure	If the same alarm occurs after resetting the BDA, request technical support.
	Reset alarm	Do not control anything during the reset.
	Manual shutdown alarm	If it has no problem regarding the installation, the HPA is On.
	Heartbeat	Check the connection of the Remote NMS Cable. Check the interval of Heartbeat on the WEB GUI.
Uplink	Oscillation detected	Check Donor/Server antenna Isolation value. If the gain value is lower than +5dB, adjust the antenna location to secure Isolation.
	Power at coverage port too high	If the UL Input Power is too high, check the Coverage antenna of the initial installation again.
	Synthesizer failure	If the same alarm occurs after resetting the BDA, request technical support.
	Hardware failure	If the same alarm occurs after resetting the BDA, request technical support.
	Software failure	If the same alarm is occurs after resetting the BDA, request technical support.
	Out-of-band emissions out of spec	It may occur when VSWR is too high and need to adjust the antenna location.
Downlink	Donor Power too high/low	Check the DL Input Power, need to adjust the antenna location.
	Low isolation	Check Donor/Server antenna Isolation value. If the Gain value is lower than +5dB, adjust the antenna location to secure Isolation.
	Synthesizer failure	If the same alarm occurs after resetting the BDA, request technical support.
	Hardware failure	If the same alarm occurs after resetting the BDA, request technical support.
	Software failure	If the same alarm occurs after resetting the BDA, request technical support.
	Spurious emissions out of spec	It may occur when VSWR is too high and need to adjust the antenna location.
	Interferer power exceeded	It may occur when VSWR is too high and need to adjust the antenna location.

Case 3) Cannot communicate with the repeater.

Problem	Check Point	Solution
<p>Cannot communicate with the repeater.</p>		<p>1. Click My Network Places → View network connections. Right-click on the Wireless Network Connection and then click Disable.</p>  <p>The screenshot shows a Windows XP desktop environment. At the top, the Start menu is open, displaying 'My Network Places' as the selected option. Below the Start menu, the 'My Network Places' window is open, showing a 'Network Tasks' pane on the left with 'View network connections' selected. Below this, the 'Network Connections' window is open, displaying a list of network connections. A context menu is open over the 'Wireless Network Connection', with the 'Disable' option highlighted.</p>

2. Right-click on the **Local Area Connection** and then click **Disable**. After clicking **Disable**, click **Enable** again.

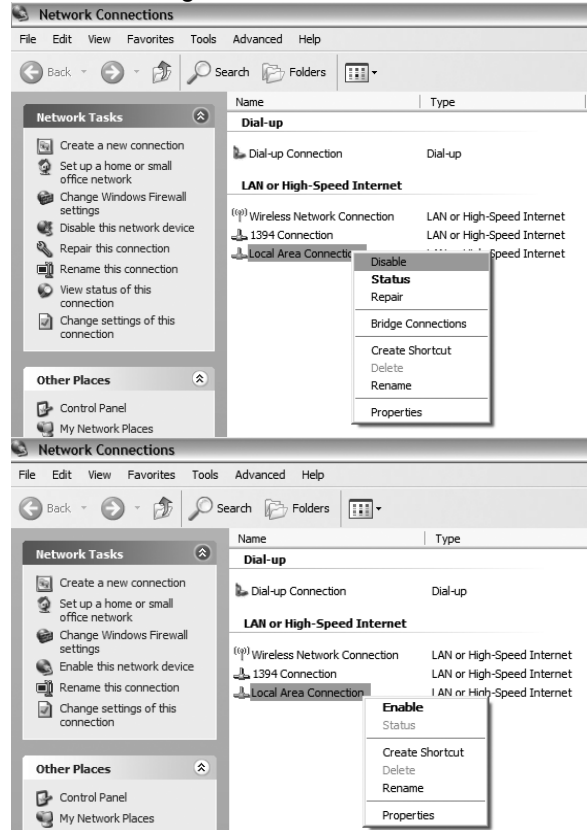

3. Double click the **Local Area Connection** and then click **Support** tab → **Repair**.



4. Open the Internet Browser and then select **Tools** → **Internet Options**. Click **Delete Files** button in the Temporary Internet files section.

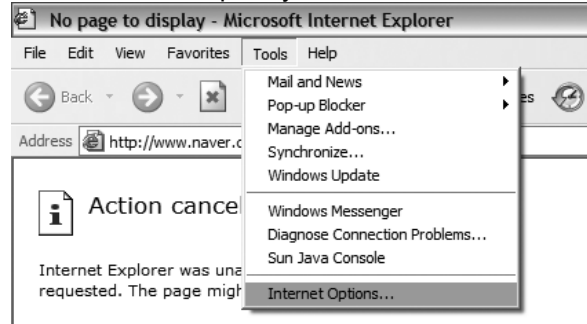

Please try the following:



5. Click **Start** and select **Run**.
Type "ping 192.168.0.1-t" and click **OK**.

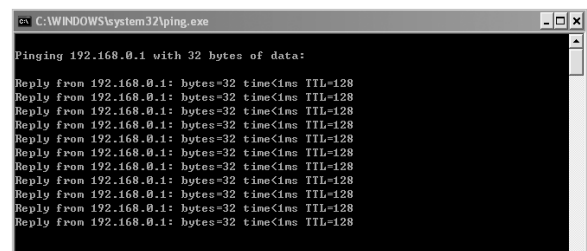
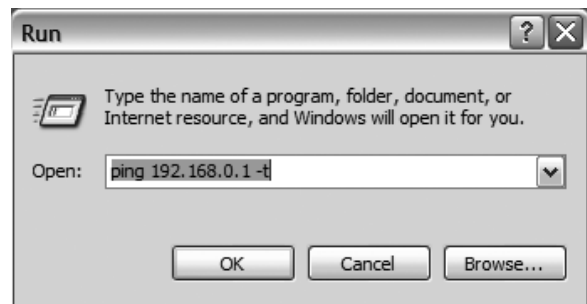

6. Specifications

6.1 RF Characteristics

6.1.1 700MHz Band

Parameter		700MHz Band	
		TX(Down-Link)	RX(Up-Link)
Frequency Range		746 - 756 MHz (C block)	777 - 787 MHz (C block)
Band Select		C block	
Channel Select		Max assumes 1x10 MHz or 2x5 MHz channels	
Service		LTE Service	
Max. Composite Input Power		-27dBm	-27dBm
Composite Output Power Range		30 dBm	30 dBm
Gain Range		57 - 87 dB	57 - 87 dB
Gain Offset			recommend -2dB
ALC	Range	30 dB	
Gain Ripple		± 2 dB peak to peak	
Noise Figure	BDA Only	≤ 5 dB	≤ 5 dB
	System	≤ 7 dB	≤ 7 dB
EVM		8%-12.5%	12.5%-17.5%
Operation at Minimum Stability Point (EVM)	15dB Coupling	8%	12.50%
	10dB Coupling	12.50%	14.50%
	5dB Coupling	17.50%	17.50%
Cancellation Window		1 μsec	
Cancellation Depth		Isolation+5dB	
Roll-off		50 dBc at ± 1 MHz	
Spurious Emission		FCC role	
Return Loss		> 15dB	
Propagation Delay		< 6 μs	
Impedance		50Ω	

6.1.2 Cellular Band

Parameter		Cellular Band	
		TX(Down-Link)	RX(Up-Link)
Frequency Range		869 - 894 MHz (A1,B1,A2,B2)	824 - 849 MHz (A1,B1,A2,B2)
Band Select		(B1 and B2) or (A1 and A2) or (all of A and all of B)	
Channel Select		Max assumes 15 contiguous(non-contiguous) carriers in all of A and all of B	
Service		CDMA2000 or EV-DO Service	
Max. Composite Input Power		-33dBm	-33dBm
Composite Output Power Range		25dBm	25dBm
Gain Range		60 - 90 dB	60 - 90 dB
Gain Offset			±3dB
ALC	Range	25 dB	
Gain Ripple		± 2 dB peak to peak	
Gain Flatness		5 dB peak to peak	
Noise Figure	BDA Only	≤ 5 dB	≤ 5 dB
	System	≤ 7 dB	≤ 7 dB
EVM		12.5% - 14.75% (EV-DO) 14.75% - 17.5% (CDMA2k)	14.75%-17.5% (EV-DO) 14.75% - 17.5% (CDMA 2k)
Operation at Minimum Stability Point (EVM)	15dB Coupling	12.5% (EV-DO) 17% (CDMA2k)	15% (EV-DO) 17% (CDMA2k)
	10dB Coupling	14.75% (EV-DO) 19.25% (CDMA2k)	17% (EV-DO) 19.25% (CDMA2k)
	5dB Coupling	17.5% (EV-DO) 19.25% (CDMA2k)	19.25% (EV-DO) 19.25% (CDMA2k)
Cancellation Window		1 μsec	
Cancellation Depth		Isolation+5dB	
Roll-off	sub-band edge	45dBc at ± 1.5 MHz from each cellular sub-band edge	
	band edge	B1 and B2 30dBc at ±750kHz from band edge	
Spurious Emission		Section 22, 24 and section 15 of FCC	
Return Loss		> 15dB	
Propagation Delay		< 6 μs	
Impedance		50Ω	

6.1.3 PCS Band

Parameter	PCS Band		
	TX(Down-Link)	RX(Up-Link)	
Frequency Range	1930 - 1990 MHz (A,D,B,E,F,C)	1850 - 1910 MHz (A,D,B,E,F,C)	
Band Select	Up to 20 MHz of spectrum in no more than 3 non-contiguous PCS sub-bands of 5, 10 or 15 MHz		
Channel Select	Max assumes 15 contiguous(non-contiguous) carriers in 20MHz		
Service	CDMA2000 or EV-DO Service		
Max. Composite Input Power	-37dBm	-37dBm	
Composite Output Power Range	30 dBm	30 dBm	
Gain Range	67 - 97 dB	67 - 97 dB	
Gain Offset		±3dB	
ALC	Range	30 dB	
Gain Ripple	± 2 dB peak to peak		
Gain Flatness	5 dB peak to peak		
Noise Figure	BDA Only	≤ 5 dB	≤ 5 dB
	System	≤ 7 dB	≤ 7 dB
EVM	12.5% - 14.75% (EV-DO) 14.75% - 17.5% (CDMA2k)	14.75%-17.5% (EV-DO) 14.75% - 17.5% (CDMA 2k)	
Operation at Minimum Stability Point (EVM)	15dB Coupling	12.5% (EV-DO) 17% (CDMA2k)	15% (EV-DO) 17% (CDMA2k)
	10dB Coupling	14.75% (EV-DO) 19.25% (CDMA2k)	17% (EV-DO) 19.25% (CDMA2k)
	5dB Coupling	17.5% (EV-DO) 19.25% (CDMA2k)	19.25% (EV-DO) 19.25% (CDMA2k)
Cancellation Window	1 μsec		
Cancellation Depth	Isolation+5dB		
Roll-off	45dBc at ± 2 MHz from each PCS sub-band edge		
Spurious Emission	Section 22, 24 and section 15 of FCC		
Return Loss	> 15dB		
Propagation Delay	< 6 μs		
Impedance	50Ω		

6.1.4 AWS Band

Parameter	AWS Band		
	TX(Down-Link)	RX(Up-Link)	
Frequency Range	2115 - 2155 MHz (A,B,C,D,E,F)	1715 - 1775 MHz (A,B,C,D,E,F)	
Band Select	Up to 20 MHz of spectrum in no more than 3 non-contiguous AWS sub-bands of 5, 10 or 15 MHz		
Channel Select	Max assumes 15 contiguous(non-contiguous) carriers in 20MHz		
Service	CDMA2000 or LTE Service		
Max. Composite Input Power	-37dBm	-37dBm	
Composite Output Power Range	30 dBm	30 dBm	
Gain Range	67 - 97 dB	67 - 97 dB	
Gain Offset		±3dB	
ALC	Range	30 dB minimum.	
Gain Ripple		± 2 dB peak to peak	
Gain Flatness		5 dB peak to peak	
Noise Figure	BDA Only	≤ 5 dB	≤ 5 dB
	System	≤ 7 dB	≤ 7 dB
EVM		12.5% - 14.75% (EV-DO) 14.75% - 17.5% (CDMA2k)	14.75%-17.5% (EV-DO) 14.75% - 17.5% (CDMA 2k)
Operation at Minimum Stability Point (EVM)	15dB Coupling	12.5% (EV-DO) 17% (CDMA2k)	15% (EV-DO) 17% (CDMA2k)
	10dB Coupling	14.75% (EV-DO) 19.25% (CDMA2k)	17% (EV-DO) 19.25% (CDMA2k)
	5dB Coupling	17.5% (EV-DO) 19.25% (CDMA2k)	19.25% (EV-DO) 19.25% (CDMA2k)
Cancellation Window		1 μsec	
Cancellation Depth		Isolation+5dB	
Roll-off		45dBc at ± 2 MHz from each AWS sub-band edge	
Spurious Emission		Section 22, 24 and section 15 of FCC	
Return Loss		> 15dB	
Propagation Delay		< 6 μs	
Impedance		50Ω	

6.2 Mechanical Specification

Parameter	Specifications	Remark
RF connectors	N-female x 2	
Dimensions (WxHxD)	19 * 10.47 * 17.72 Inch 482.6 * 265.9 * 450 mm	W * D * H
Weight	132.45 lb 60 Kg max	

6.3 Environmental Specification

Parameter	Specifications	Remark
Cooling	Convection	
Working Temperature	-10 - +50 °C	
Splash, Dust	IP -40	Indoor enclosure

7. Appendix

Quad Band Channel

700MHz Band

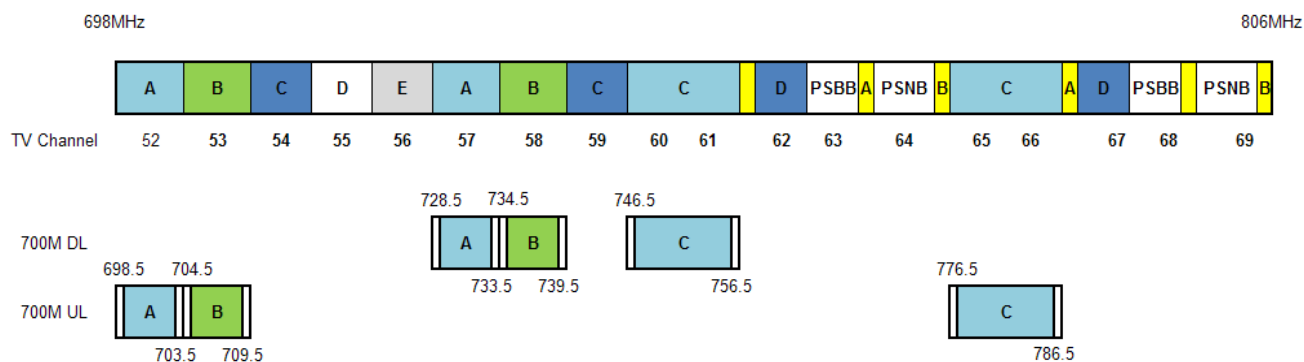

Cellular Band

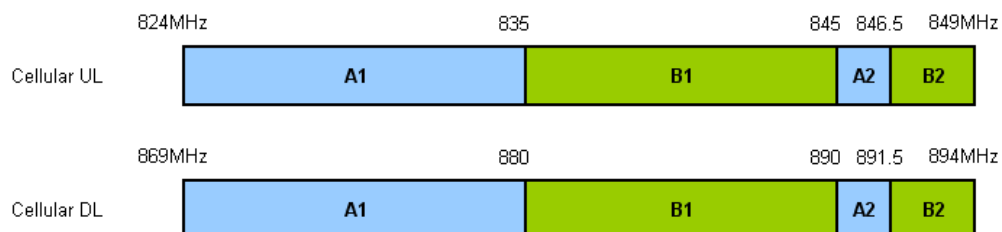

PCS Band

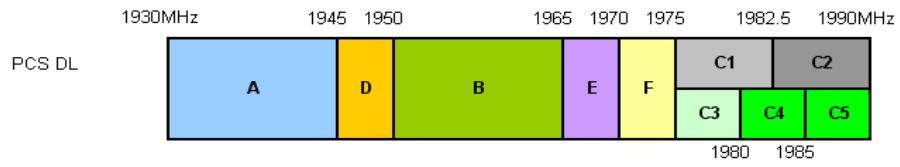
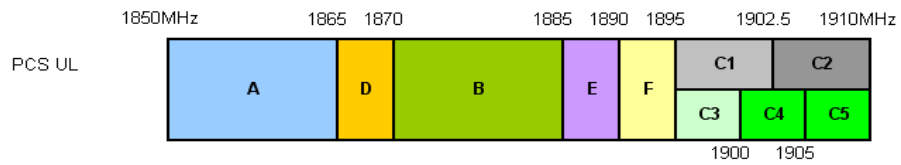

AWS Band

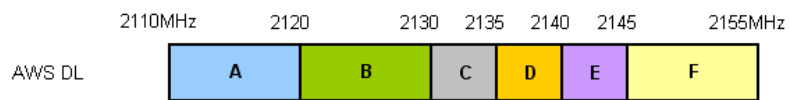
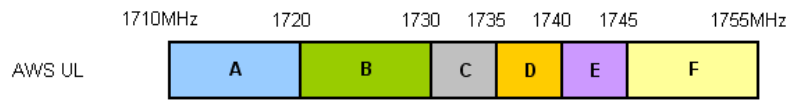

Warranty

LIMITED WARRANTY

This product, as supplied and distributed by R-tron, in the original carton, is warranted by R-tron against manufacturing defects in materials and workmanship for a limited warranty period of:

Five (5) Year Parts and Labor

This limited warranty begins on the original date of purchase, and is valid only on products purchased and used in the United States. R-tron will repair or replace this product, at our option and at no charge as stipulated herein, with new or reconditioned parts or products if found to be defective during the limited warranty period specified above. All replaced parts and products become the property of R-tron and must be returned to R-tron. Replacement parts and products assume the remaining original warranty.

This limited warranty covers manufacturing defects in materials and workmanship encountered in normal, and except to the extent otherwise expressly provided for in this statement, use of this product, and shall not apply to the following, including, but not limited to: damage which occurs in installation; applications and uses for which this product was not intended; altered product or serial numbers; cosmetic damage or exterior finish; accidents, abuse, neglect, fire, water, lightning or other acts of nature; use of products, equipment, systems, utilities, services, parts, supplies, accessories, applications, installations, repairs, external wiring or connectors not supplied or authorized by R-tron which damage this product or result in service problems; or incorrect electrical line voltage, fluctuations and surges; customer adjustments and failure to follow operating instruction. R-tron does not warrant uninterrupted or error-free operation of the product.

THERE ARE NO EXPRESS WARRANTIES OTHER THAN THOSE LISTED AND DESCRIBED ABOVE, AND NO WARRANTIES WHETHER EXPRESS OR IMPLIED, INCLUDING, BUT NOT LIMITED TO, ANY IMPLIED WARRANTIES OF MERCHANTABILITY OR FITNESS FOR A PARTICULAR PURPOSE, SHALL APPLY AFTER THE EXPRESS WARRANTY PERIODS STATED ABOVE, AND NO OTHER EXPRESS WARRANTY OR GUARANTY GIVEN BY ANY PERSON, FIRM OR CORPORATION WITH RESPECT TO THIS PRODUCT SHALL BE BINDING ON R-tron.

Return Material Authorization(RMA) Procedure

The return and exchange of products are not allowed without prior approval from R-tron America, Inc.

Please follow the exchange procedure below.

1. Call Tech Support for troubleshooting.
2. If the device has a hardware problem, R-tron will replace it if it is within warranty. A RMA number will be issued for the return.
3. R-tron will ship the replacement and a return label will be provided.
4. The customer must return the product using the original packaging, including accessories.

