



**MOTOROLA**

**USER'S GUIDE**

**Model: SCOUT1500**

**DIGITAL VIDEO PET MONITOR with  
INDOOR & OUTDOOR PET UNITS**

USER'S GUIDE

The features described in this User's Guide are subject to modifications without prior notice.

# Welcome...

## ***to your new Motorola Digital Video Pet Monitor with Indoor & Outdoor Pet Units!***

Thank you for purchasing your new Digital Video Pet Monitor with Indoor and Outdoor pet units. If you have always wondered what your pet is up to when you are away, wonder no more. Now you can monitor your pet's activities from another room. With the outdoor pet unit, you can also see what your pet(s) is doing in the backyard.

Please retain your original dated sales receipt for your records. For warranty service of your Motorola product, you will need to provide a copy of your dated sales receipt to confirm warranty status. Registration is not required for warranty coverage.

For product related questions, please call:

**US and Canada 1-888-331-3383**

**On the Web: [www.motorola.com](http://www.motorola.com)**

---

This User's Guide provides you with all the information you need to get the most out of your product.

Before you can use your new Digital Video Pet Monitor, we recommend that you fully charge the battery of the digital video pet monitor by inserting it in the owner unit. This will allow it to continue to work even if you disconnect it from the power supply to carry it to another location. Please read the Safety Instructions on page 6 before installation.

## **Got everything?**

- 1 x Owner Unit
- 1 x Indoor Pet Unit
- 1 x Outdoor Pet Unit
- 1 x Rechargeable Ni-MH Battery Pack for the Owner Unit
- 1 x Power adapter for the Owner Unit
- 1 x Power adapter for the Indoor Pet Unit
- 1 x Power adapter with connector for the Outdoor Pet Unit
- 4 x Mounting Screws and Dry Wall Plugs
- 1 x Tamper-proof Screw
- 1 x Metal Bracket
- 1 x Wrench Key

In multi-camera packs, you will find one or more additional pet units with power adapter units.

# Overview of the Owner Unit

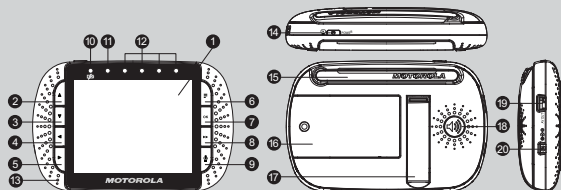

- 1.** Display (LCD screen)
- 2.** Up Key ▲  
Normal Mode: Tilt Up  
Menu Mode: Up
- 3.** Down Key ▼  
Normal Mode: Tilt Down  
Menu Mode: Down
- 4.** Left Key ◀  
Normal Mode: Pan Left  
Menu Mode: Left
- 5.** Right Key ▶  
Normal Mode: Pan Right  
Menu Mode: Right
- 6.** Menu Key ≡  
Press to open the Menu options
- 7.** OK Key **OK**
- 8.** Quick Scan key ▶▶  
Press to double the video pan and tilt speed.  
Press again to return to normal speed.
- 9.** Talk Key 🗣️  
Press and hold to talk to your pet
- 10.** Power Adapter / Battery LED  
BLUE when mains adapter power on.  
RED when battery low.
- 11.** Unit ON/OFF LED (Green)
- 12.** Audio Level LED (Green, Orange, Red, Red)
- 13.** Microphone
- 14.** Power / Video ON-OFF key  
  
Press and Hold to turn the unit ON/OFF  
Press once to turn ON and OFF the LCD display
- 15.** Antenna  
Lift the antenna for optimal reception
- 16.** Battery cover
- 17.** Stand
- 18.** Speaker
- 19.** USB connector  
Connection to AV output  
\* AV Cable (Optional accessory, purchased separately)
- 20.** Power Adapter connector

## Owner unit menu icons

	Signal Level (5 Levels)
	Night Vision Mode (Screen changes to Black/White)
	Talk Mode
	Battery Level Control (4 Levels)
	Pan Left
	Pan Right
	Tilt Up
	Tilt Down
	Volume Level Control (8 Levels)
	Brightness Level Control (8 Levels)
	Soothing Pet Music Control (5 Song Selections)
	Zoom Level Control (1X, 2X)
	Alarm Setting (6h, 4h, 2h, OFF)
	Cam Control (scan, view, add, del)
	Temperature Reading (HH °C / °F or LL °C / °F) Icon & readings turn RED > 29°C / 84°F, and reading display HH °C / °F > 36°C / 97°F) Icon & readings turn RED < 14°C / 57°F, and reading display LL °C / °F < 1°C / 34°F)

## Overview of Indoor Pet Unit

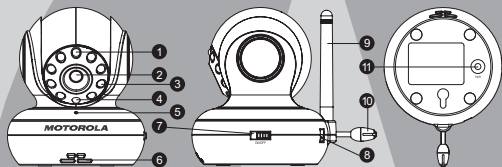

1. Photo Sensor (Night Vision Mode)
2. Camera Lens
3. Infrared LEDs
4. Power LED
5. Microphone
6. Speaker
7. ON/OFF Switch
8. Power Adapter Connector
9. Antenna
10. Temperature Sensor
11. Pair Key

# Overview of Outdoor Pet Unit

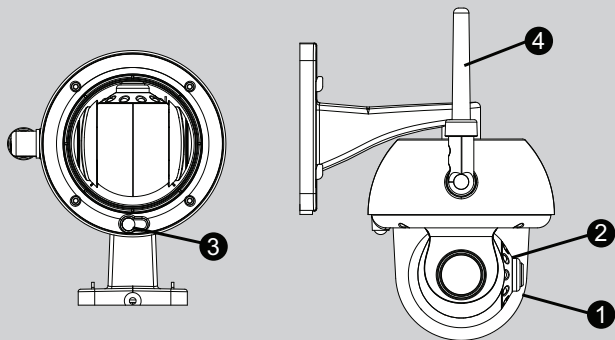

1. Camera Lens
2. Infrared LEDs
3. Pair Key
4. Antenna

## Important guidelines for installing your digital video pet monitor

- To use your Pet Units and Owner Unit together, you must be able to establish a radio link between them, and the range will be affected by environmental conditions.
- Any large metal object, like a refrigerator, a mirror, a filing cabinet, metallic doors or reinforced concrete between the Camera and Owner Unit may block the radio signal.
- The signal strength may also be reduced by other solid structures, like walls, or by radio or electrical equipment, such as TVs, computers, cordless or mobile phones, fluorescent lights or dimmer switches.
- Use of other 2.4GHz products, such as wireless networks Wi-Fi<sup>®</sup> routers), Bluetooth<sup>®</sup> systems, or microwave ovens, may cause interference with this product, so keep the monitor at least 5ft (1.5m) away from these products, or turn them off if they appear to be causing interference.
- If the signal is weak, try moving the Monitor and/or the Pet Units to different positions in the rooms or outdoor area.



## Table of contents

<b>1. Safety Instructions</b> .....	<b>7</b>
<b>2. Getting Started</b> .....	<b>12</b>
2.1 Indoor Pet Unit Power Supply .....	12
2.2 Owner Unit Battery Installation.....	12
2.3 Owner Unit Power Supply .....	13
2.4 Outdoor Pet Unit Installation .....	14
2.4.1 Mounting the Outdoor Pet Unit .....	15
2.5 Registration (Pairing).....	17
2.6 View Video Through TV .....	17
<b>3. Using the Digital Video Pet Monitor</b> .....	<b>18</b>
3.1 Setup.....	18
3.2 Pan and Tilt.....	18
3.3 Night Vision Mode .....	18
3.4 Talk Mode (Not applicable for Outdoor Pet Unit).....	18
3.5 Video ON/OFF .....	19
3.6 Temperature Display (HH °C / °F or LL °C / °F) (Not applicable for Outdoor Pet Unit).....	19
<b>4. Owner Unit Menu Options</b> .....	<b>20</b>
4.1 Volume (Not applicable for Outdoor Pet Unit) .....	20
4.2 Brightness .....	20
4.3 Soothing Pet Music (Not applicable for Outdoor Pet Unit).....	20
4.4 Zoom.....	20
4.5 Alarm.....	21
4.6 Camera Control.....	21
4.6.1 Add (pair) a camera .....	21
4.6.2 View a camera .....	21
4.6.3 Delete a camera.....	22
4.6.4 Scan cameras.....	22
4.7 Temperature (Not applicable for Outdoor Pet Unit).....	22
<b>5. Disposal of The Device (environment)</b> .....	<b>23</b>
<b>6. Cleaning</b> .....	<b>23</b>
<b>7. Help</b> .....	<b>24</b>
<b>8. General Information</b> .....	<b>26</b>



## 1. Safety Instructions



This symbol indicates that dangerous voltage constituting a risk of electric shock is present within this unit.



This symbol indicates that there are important operating and maintenance (servicing) instructions in the literature accompanying the unit.

**WARNING: VOLTAGES IN THIS UNIT ARE HAZARDOUS TO LIFE. DO NOT REMOVE COVERS. THERE IS NO USER SERVICEABLE PARTS INSIDE.**

**CAUTION: TO PREVENT ELECTRIC SHOCK, MATCH THE WIDE BLADE OF THE PLUG TO THE WIDE SLOT**



### **WARNING:**

**STRANGULATION HAZARD –** In case this unit is being used to monitor infants or children, keep the unit and adapter cord more than 3 feet from the crib and out of their reach. Never place camera or cords within a crib or near a bed. Secure the cord away from children's reach. Never use extension cords with AC Adapters. Only use the AC Adapters provided.

As with any electrical device, supervision of your pet's usage should be exercised until your pet is acclimated to the product. If your pet is prone to chewing, we strongly recommend you keep this and all other electrical devices out of its reach.

---

### **CAMERA SET UP & USE:**

---

- Determine a location for the CAMERA that will provide the best view of your pet in its area of activity.
- Place the CAMERA on a flat surface, such as a dresser, desk or shelf.



## **WARNING**

*This digital video pet monitor is compliant with all relevant standards regarding electromagnetic fields and is, when handled as described in the User's Guide, safe to use. Therefore, always read the instructions in this User's Guide carefully before using the device.*

- Adult assembly is required. Keep small parts away from children and pet(s) when assembling.
- This product is not a toy. Do not allow children or pet(s) to play with it.
- This digital video pet monitor is not a substitute for responsible supervision and interaction.
- Keep this User's Guide for future reference.
- Do not place the Indoor Pet Unit or cables in the cot / crib or within reach of the pet (the unit should be at least 3 feet away).
- Keep the cords out of reach of children and pet(s).
- Do not cover the digital video pet monitor with a towel or blanket.
- Never use extension cords with power adapters. Only use the power adapters provided.
- Test this monitor and all its functions so that you are familiar with it prior to actual use.
- Do not use the digital video pet monitor near water.
- Do not install the digital video pet monitor near a heat source.
- Only use the chargers and power adapters provided. Do not use other chargers or power adapters as this may damage the device and battery pack.
- Only insert a battery pack of the same type.
- Do not touch the plug contacts with sharp or metal objects.

## **CAUTION**

*There is a risk of explosion if battery is replaced by an incorrect type. Please dispose of used batteries according to the instructions.*



---

## Important instructions:

- **Read and Follow Instructions** - Please read all the safety and operating instructions before operating the product. Follow all operating instructions.
- **Retain Instructions** - The safety and operating instructions should be retained for future reference.
- **Heed Warnings** - Comply with all warnings on the product and in the operating instructions.
- **Polarization** - Do not defeat the safety purpose of the polarized or grounding-type plug. A polarized plug has two blades with one wider than the other. A grounding type plug has two blades and a third grounding prong. The wide blade or the third prong is provided for your safety. If the supplied plug does not fit into your outlet, consult an electrician for replacement of the obsolete outlet.
- **Power Sources** - This product should be operated only from the type of power source indicated on the marking label. If you are not sure of the type of power supplied to your location, consult your camera dealer or local power company. For products intended to operate from battery power, or other sources, please refer to the operating instructions
- **Overloading** - Do not overload wall outlets or extension cords as this can result in the risk of fire or electric shock. Overloaded AC outlets, extension cords, frayed power cords, damaged or cracked wire insulation, and broken plugs are dangerous. They may result in a shock or fire hazard. Periodically examine the cord, and if its appearance indicates damage or deteriorated insulation, have it replaced by your service technician.
- **Power-Cord Protection** - Power supply cords should be routed so that they are not likely to be walked on or pinched by items placed upon or against them. Pay particular attention to cords at plugs, convenience receptacles, and the point where they exit from the product.



- **Surge Protectors** - It is highly recommended that the camera equipment be connected to a surge protector. Doing so will protect the equipment from damage caused by power surges. Surge protectors should bear the UL listing mark or CSA certification mark.
- **Uninterruptible Power Supplies (UPS)** - Because this product is designed for continuous, 24/7 operation, it is recommended that you connect the product to an uninterruptible power supply. An uninterruptible power supply has an internal battery that will keep the product running in the event of a power outage. Uninterruptible power supplies should bear the UL listing mark or CSA certification mark.  
**CAUTION:** Maintain electrical safety. Power line operated equipment or accessories connected to this product should bear the UL listing mark or CSA certification mark on the accessory itself and should not be modified so as to defeat the safety features. This will help avoid any potential hazard from electrical shock or fire. If in doubt, contact qualified service personnel.
- **Ventilation** - Slots and openings on the case are provided for ventilation to ensure reliable operation of the product and to protect it from overheating. These openings must not be blocked or covered. The openings should never be blocked by placing the camera equipment on a bed, sofa, rug, or other similar surface. This product should never be placed near or over a radiator or heat register. This product should not be placed in a built-in installation such as a bookcase or rack unless proper ventilation is provided and the product manufacturer's instructions have been followed.
- **Attachments** - Do not use attachments unless recommended by the product manufacturer, as they may cause a hazard.
- **Water and Moisture** - Do not use receivers or video monitors near water - for example, near a bath tub, sink or laundry tub, in a wet basement, near a swimming pool, etc.
- **Heat** - The product should be located away from heat sources such as radiators, heat registers, stoves, or other products (including amplifiers) that produce heat.



- **Accessories** - Do not place this camera equipment on an unstable cart, stand, tripod, or table. The camera equipment may fall, causing serious damage to the product. Use this product only with a cart, stand, tripod, bracket, or table recommended by the manufacturer or sold with the product. Any mounting of the product should be according to the manufacturer's instructions and use a mounting accessory recommended by the manufacturer.
- **Camera Extension Cables** - Check the rating of your extension cable to verify its compliance prior to installation.
- **Mounting** - The cameras provided with this system should be mounted only as instructed in this guide or the instructions that came with your cameras, using the supplied mounting brackets.
- **Camera Installation** - Cameras are not intended for submersion in water. Not all cameras can be installed outdoors. Check your camera environmental rating to confirm if they can be installed outdoors. When installing cameras outdoors, installation in a sheltered area is required.



## 2. Getting Started

### 2.1 Indoor Pet Unit Power Supply

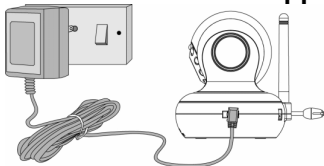

1. Connect the small plug of the power adapter to the Indoor Pet Unit and the other end to the electrical outlet.

#### **NOTE**

*Only use the enclosed power adapter (5.9V DC / 1000mA).*

2. Slide the ON/OFF switch to the ON position. The power LED will light up in green.
3. Slide the ON/OFF switch to the OFF position to turn the Indoor Pet Unit off.

### 2.2 Owner Unit Battery Installation

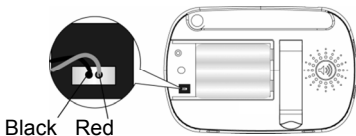

1. Insert the wire tab of the rechargeable battery pack into the contact slot as shown above and fit the battery pack into the compartment.

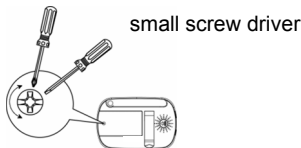

2. Replace the battery cover over the compartment and gently tighten the screw in a clockwise direction using a small screw driver.



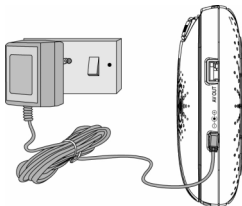

## 2.3 Owner Unit Power Supply



### **IMPORTANT**

*Installing the rechargeable battery pack and charging it fully before use is recommended. This will allow the unit to operate on battery in the event of a power failure.*

1. Connect the small plug of the power adapter to the Owner unit and the other end to the electrical outlet. Only use the enclosed power adapter (6V DC/500mA).
2. Press and hold the  POWER ON/OFF button for 1 second to turn ON the Owner unit.
3. Once the Pet and Owner units are switched on, the display on the Owner unit will show the video captured by the Indoor Pet Unit.
4. If there is no connection or you are out of range, the video display will go off and the words **No Signal** will be shown on the LCD display, and the unit will beep every 5 seconds. Move the Owner unit closer to the Indoor Pet Unit until the link is re-established.
5. Press and hold the  POWER ON/OFF button, until the progress bar finishes scrolling, to turn OFF the Owner unit.

### **NOTE**

*The battery icon  turns RED to indicate that the battery is low, and it gives a beep every 16 seconds. The battery needs to be recharged. The battery pack takes about 16 hours to be fully charged.*

### **When charging**

1. During power OFF, when adapter is plugged in, an adapter logo will display on screen and then a flashing battery logo will display for 45 sec. The Blue LED at top left corner light up indicates that the adapter is plugged in.



2. During power ON, when the adapter is plugged in, the battery icon on screen's top right corner will show that the battery is charging. The Blue LED at the top left corner lights up to indicate that the adapter is plugged in.

## 2.4 Outdoor Pet Unit Installation



### IMPORTANT

- This product is not intended for submersion in water. For outdoor use, mount it in a sheltered place where it is not directly exposed to rain or snow.
- Determine a location for the Pet Unit that will provide the best view of the surrounding environment and activities you wish to monitor.
- Select a location for the camera that has an ambient temperature between 14°F~122°F (-10°C~50°C).
- Avoid installing the camera where there are thick walls or obstructions between the camera and the owner unit.
- Avoid installing in a location which requires the wireless signal to pass through cement, concrete, and metal structures. This will reduce the range of transmission.
- Carefully plan where and how the Pet Unit will be positioned and where you will route the cable that connects the Pet Unit to the power adapter.
- Aim the camera(s) to best optimize the viewing area: select a location for the camera that provides a clear view of the area you want to monitor, that is free from dust, and that is not in line-of-sight to a strong light source or direct sunlight.
- Before starting permanent installation, verify the Pet Unit's performance by observing the image on a monitor when the Pet Unit is positioned in the same location/position where it will be permanently installed.
- Avoid letting power cords rub against any sharp edges or lie across any high traffic areas where people might trip over them.



## 2.4.1 Mounting the Outdoor Pet Unit

The Pet Unit is built with durable aluminum, weather resistant housing\* so you can use it outdoors in almost any weather condition. Use the provided wall mounting accessory pack (4 mounting screws and drywall plugs, 1 tamper-proof screw, 1 metal bracket, 1 wrench key) and follow the process below for installing the Outdoor Pet Unit.

*\*Not for use in direct exposure to water, rain or snow.*

1. Mark the position of the screw holes on the wall.

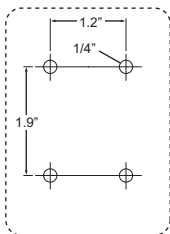

2. Drill 4 holes and hammer the drywall plugs (included) into the holes as needed.

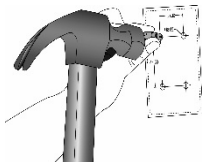
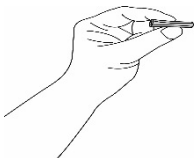
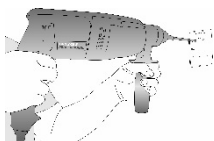

3. Fasten the mounting plate on the wall by 4 provided Philips head screws.

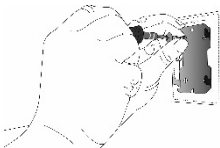



4. Place the 4 mounting slots of the camera base on to 4 catches on the mounting plate. Make sure the Pet Unit sits firmly on the mounting plate with the center holes of 2 parts lined up.

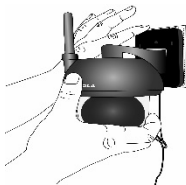

5. Fasten the Pet Unit to the mounting plate at the center hole with the tamper-proof screw by the wrench key provided.



6. Plug the Pet Unit's power adapter into the cord on the camera and then plug the adapter into the electrical outlet.

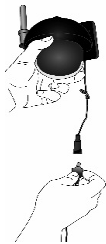

## NOTE

*Only use the enclosed power adapter (5.9V DC / 1000mA).*



## 2.5 Registration (Pairing)

The Indoor and Outdoor Pet Units are pre-registered to your Owner Unit. You do not need to register it again unless the Indoor Pet Unit loses its link with the Owner Unit.

To re-register your Indoor Pet Unit, or register a new Indoor Pet Unit, follow the procedure below:

1. Press the **≡** button of the Owner unit and the menu bar will pop up.
2. Press the **◀ LEFT** button or **▶ RIGHT** button until **@** is highlighted, and the **del/add/view/scan** menu will pop up.
3. Press the **▲ UP** button or **▼ DOWN** button to select **ADD**, and press the **OK** button to confirm.
4. **CAM 1 / CAM 2 / CAM 3 / CAM 4** will pop up, press the **▲ UP** button or **▼ DOWN** button to select the desired CAM and press the **OK** button to start searching for a pet unit. The green audio level LED will flash rapidly while searching.
5. Press the **OK** button to confirm.
6. Press and hold the **PAIR** button underneath the Indoor Pet Unit until the Owner unit finds the camera, beeps and the video from the camera appears.

### **NOTE**

*If a particular Indoor Pet Unit was registered previously, registering this current Indoor Pet Unit again will overwrite the previous registration.*

## 2.6 View Video Through TV

Connect a suitable AV cable into the AV OUT socket on the side of the Owner Unit and into the AV input of the TV. Scroll through the AV inputs on the TV menu until the Indoor Pet Unit picture is visible.

An AV cable is an optional accessory available for purchase separately.

### **NOTE**

*The Indoor Pet Unit's power button must be turned ON and CAM pre-selected before connecting the AV cable. Once the AV cable is connected, the Indoor Pet Unit's controls cannot be activated.*



## 3. Using the Digital Video Pet Monitor

### 3.1 Setting up

- Place the Indoor Pet Unit in a convenient location (e.g. on a table) and point the camera lens towards the area you want to monitor.
- Mount the Outdoor Pet Unit on the wall under the shelter (recommended) and point the camera lens towards the area you want to monitor.
- Adjust the Indoor Pet Unit's head angle by rotating the camera up, down, left and right until you are satisfied with the image in the Owner unit.

#### **NOTE**

*Do not place the Indoor Pet Unit within reach of a child or pet(s)! If there is interference with the picture or sound, try moving the units to different locations, and ensure they are not close to other electrical equipment.*

### 3.2 Pan and Tilt

The camera can be remotely controlled from the Owner unit.

1. Press the ▲ UP button or ▼ DOWN button to tilt upward or downward.
2. Press the ◀ LEFT button or ▶ RIGHT button to pan left or right.

#### **NOTE (applicable for outdoor pet unit video feed)**

*You can press the ►► Quick Scan button to double the pan and tilt speed for quick search. Toggle the button again for returning to normal speed.*

### 3.3 Night Vision Mode

The Indoor Pet Unit has 8 high-intensity infrared LEDs for picking up clear images in the dark. When the built-in photo sensor detects a low level of ambient light, the LEDs will automatically activate and the screen on the Owner unit will display in black and white. The ☾ icon will be displayed on the screen.

### 3.4 Talk Mode (Not applicable for Outdoor Pet Unit)

Press and hold the 🗣️ TALK button on the Owner unit to talk to your pet through the Indoor Pet Unit's loudspeaker. The 🗣️ icon will be displayed at the top of the LCD screen.



### **3.5 Video ON/OFF**

Press  VIDEO ON/OFF key to turn the LCD display on or off, but will still leave the audio monitor on.

### **3.6 Temperature Display (HH °C / °F or LL °C / °F) (Not applicable for Outdoor Pet Unit)**

The temperature reading from the temperature sensor at the back of the Indoor Pet Unit will be displayed at the top of the LCD screen.

The readings will turn RED if the temperature goes above 29°C / 84°F or below 14°C / 57°F. The reading will change to HH °C / °F if the temperature goes above 36°C / 97°F. The reading will change to LL °C / °F if the temperature goes below 1°C / 34°F.



## 4. Owner Unit Menu Options

### 4.1 Volume (Not applicable for Outdoor Pet Unit)

1. Press the button and the menu bar will pop up.
2. Press the LEFT button or button until is highlighted.
3. Press the UP button or DOWN button to select the desired volume level from level 1 ~ 8. (The default volume level setting is level 4.)

### 4.2 Brightness

1. Press the button and the menu bar will pop up.
2. Press the LEFT button or button until is highlighted.
3. Press the UP button or DOWN button to select the desired brightness level from level 1 ~ 8. (The default brightness level setting is level 4.)

### 4.3 Soothing Pet Music (Not applicable for Outdoor Pet Unit)

1. Press the button and the menu bar will pop up.
2. Press the LEFT button or button until is highlighted.
3. Press the UP button or button to select the desired song from the 5 pet songs available, or the cycle option to play all 5 songs in turn. If an individual song is selected it will only play once and then stop. (The default setting is music OFF)
4. Press **OK** on the selected song to select the desired song sound level.

### 4.4 Zoom

1. Press the button and the menu bar will pop up.
2. Press the LEFT button or button until is highlighted.
3. Press the UP button or DOWN button to select the 1X or 2X zoom. (The default setting is 1X.)



## 4.5 Alarm

1. Press the **≡** button and the menu bar will pop up.
2. Press the **◀ LEFT** button or **▶ RIGHT** button until  is highlighted.
3. Press the **▲ UP** button or **▼ DOWN** button to select the alarm time (6h, 4h, 2h). (The default setting is Alarm OFF.)

If an alarm time is selected, the Owner unit will beep for about 45 seconds after every 6, 4 or 2 hour period, and the  alarm icon will flash red.

## 4.6 Camera Control

### 4.6.1 Add (pair) a camera

1. Press the **≡** button and the menu bar will pop up.
2. Press the **◀ LEFT** button or **▶ RIGHT** button until  is highlighted, and the *del/add/view/scan* menu will pop up.
3. Press the **▲ UP** button or **▼ DOWN** button to select **ADD**, and press the **OK** button to confirm.
4. **CAM 1 / CAM 2 / CAM 3 / CAM 4** will pop up, press the **▲ UP** button or **▼ DOWN** button to select the desired CAM, and press the **OK** button to start searching for a pet unit. The green audio level LED will flash rapidly while searching.
5. Press and hold the **PAIR** button underneath the Indoor Pet Unit until the Owner unit finds the camera, beeps and the picture from the camera appears.

### NOTE

*A camera can only be registered to one Owner unit at any one time.*

### 4.6.2 View a camera

1. Press the **≡** button and the menu bar will pop up.
2. Press the **◀ LEFT** button or **▶ RIGHT** button until  is highlighted and the *del/add/view/scan* menu pops up.
3. Press the **▲ UP** button or **▼ DOWN** button to select **VIEW**, and press the **OK** button to confirm.
4. **CAM 1 / CAM 2 / CAM 3 / CAM 4** will pop up, press the **▲ UP** button or **▼ DOWN** button to select desired CAM, and press the **OK** button to view the picture from that camera.

**TIP**

*Quick Method to View Cameras instead of entering into the menu bar:  
Directly press **OK** repeatedly to select CAM 1, CAM 2, CAM 3, CAM 4, SCAN.*

**4.6.3 Delete a camera**

1. Press the **≡** button and the menu bar will pop up.
2. Press the **◀** LEFT button or **▶** RIGHT button until **☺** is highlighted, and the **del/add/view/scan** menu will pop up.
3. Press the **▲** UP button or **▼** DOWN button to select **DEL**, and press the **OK** button to confirm.
4. **CAM 1 / CAM 2 / CAM 3 / CAM 4** will pop up, press the **▲** UP button or **▼** DOWN button to select the desired **CAM**, and press the **OK** button to delete that registration.

**4.6.4 Scan camera**

1. Press the **≡** button and the menu bar will pop up.
2. Press the **◀** LEFT button or **▶** RIGHT button until **☺** is highlighted, and the **del/add/view/scan** menu will pop up.
3. Press the **▲** UP button or **▼** DOWN button to select **SCAN**, and press the **OK** button to confirm.
4. The screen will then display images from different registered cameras in a loop of **CAM 1 / CAM 2 / CAM 3 / CAM 4**, changing about every 12 seconds.

**TIP**

*Quick Method to View Cameras instead of entering into the menu bar:  
Directly press **OK** repeatedly to select CAM 1, CAM 2, CAM 3, CAM 4, SCAN.*

**4.7 Temperature (Not applicable for Outdoor Pet Unit)**

1. Press the **≡** button and the menu bar will pop up.
2. Press the **◀** LEFT button or **▶** RIGHT button until **ℹ** is highlighted.
3. Press the **▲** UP button or **▼** DOWN button to select **°C** or **°F**.

## 5. Disposal of The Device (environment)

At the end of the product lifecycle, you should not dispose of this product with normal household waste. Take this product to a collection point for the recycling of electrical and electronic equipment. The symbol on the product, User's Guide and/or box indicates this.



Some of the product materials can be reused if you take them to a recycling point. By reusing some parts or raw materials from used products, you are making an important contribution to the protection of the environment.

Please contact your local authorities if you need more information on the collection points in your area.

Dispose of the battery pack in an environmentally-friendly manner in accordance with your local regulations.

## 6. Cleaning

Clean your Digital Video Pet Monitor with a slightly damp cloth or with an anti-static cloth. Never use cleaning agents or abrasive solvents.

### Cleaning and care

- Do not clean any part of the product with thinners or other solvents and chemicals -- this may cause permanent damage to the product which is not covered by the warranty.
- Keep your Digital Video Pet Monitor away from hot, humid areas or strong sunlight, and don't let it get wet.
- Every effort has been made to ensure high standards of reliability for your Digital Video Pet Monitor. However, if something does go wrong, please do not try to repair it yourself -- contact Customer Service for assistance.



## 7. Help

### Display

#### *No display*

- Try recharging or replacing the battery pack.
- Reset the units. Disconnect the battery pack of the Owner unit and unplug both the units' electrical power, then plug them back in.
- Is the unit turned on?  
Press and hold the ON/OFF key on the Owner unit to turn it ON.
- Is the correct camera selected?  
Change the camera number, if necessary.
- Is the video display turned on?  
Press the VIDEO ON/OFF key to turn it on.
- When operating using batteries, only the Display will go blank after 2 minutes to save power. The unit is still active and will give you audio alerts. You can reactivate the screen by pressing any key.

### Registration

#### *If the Indoor/Outdoor Pet Unit has lost its link with the Owner Unit*

- Try recharging or replacing the battery pack.
- If the Indoor/Outdoor Pet Unit is too far away it may be going out of range, so move the Camera closer to the Owner Unit.
- Reset the units by disconnecting them from the battery and electrical power. Wait about 15 seconds before reconnecting. Allow up to one minute for the Indoor/Outdoor Pet Unit and the Owner Unit to synchronize.
- See 2.4 Registration (Pairing), if there is a need to re-register the units.



## Interference

### ***Noise interference on your Owner unit***

- Your Camera and Owner units may be too close. Move them farther apart.
- Make sure there is at least 3 to 6 feet between the Camera and Owner units to avoid audio feedback.
- If the Pet Units are too far away it may be out of range, so move the Pet Units closer to the Owner unit.
- Make sure the Camera and Owner units are not near other electrical equipment, such as a television, computer or cordless/mobile telephone.
- Use of other 2.4GHz products, such as wireless networks (Wi-Fi® routers), Bluetooth® systems, or microwave ovens, may cause interference with this product, so keep the monitors at least 5ft (1.5m) away from these types of products, or turn them off if they appear to be causing interference.
- If the signal is weak, try moving the Owner and/or the Pet Units to different positions in the rooms outdoor area.



## 8. General Information

If your product is not working properly....

1. Read this User's Guide or the Quick Start Guide.
2. Visit our website:  
[www.motorola.com](http://www.motorola.com)
3. Contact Customer Service:  
US and Canada 1-888-331-3383

To order a replacement battery pack, contact customer service.

### **Consumer Products and Accessories Limited Warranty ("Warranty")**

Thank you for purchasing this Motorola branded product manufactured under license by Binatone Electronics International LTD ("BINATONE").

#### ***What Does this Warranty Cover?***

Subject to the exclusions contained below, BINATONE warrants that this Motorola branded product ("Product") or certified accessory ("Accessory") sold for use with this product that it manufactured to be free from defects in materials and workmanship under normal consumer usage for the period outlined below. This Warranty is your exclusive warranty and is not transferable.

#### ***Who is covered?***

This Warranty extends only to the first consumer purchaser, and is non-transferable.

***What will BINATONE do?***

BINATONE or its authorized distributor at its option and within a commercially reasonable time, will at no charge repair or replace any Products or Accessories that does not conform to this Warranty. We may use functionally equivalent reconditioned / refurbished / pre-owned or new Products, Accessories or parts.

***What Other Limitations Are There?***

ANY IMPLIED WARRANTIES, INCLUDING WITHOUT LIMITATION THE IMPLIED WARRANTIES OF MERCHANTABILITY AND FITNESS FOR A PARTICULAR PURPOSE, SHALL BE LIMITED TO THE DURATION OF THIS LIMITED WARRANTY, OTHERWISE THE REPAIR OR REPLACEMENT PROVIDED UNDER THIS EXPRESS LIMITED WARRANTY IS THE EXCLUSIVE REMEDY OF THE CONSUMER, AND IS PROVIDED IN LIEU OF ALL OTHER WARRANTIES, EXPRESS OF IMPLIED. IN NO EVENT SHALL MOTOROLA OR BINATONE BE LIABLE, WHETHER IN CONTRACT OR TORT (INCLUDING NEGLIGENCE) FOR DAMAGES IN EXCESS OF THE PURCHASE PRICE OF THE PRODUCT OR ACCESSORY, OR FOR ANY INDIRECT, INCIDENTAL, SPECIAL OR CONSEQUENTIAL DAMAGES OF ANY KIND, OR LOSS OF REVENUE OR PROFITS, LOSS OF BUSINESS, LOSS OF INFORMATION OR OTHER FINANCIAL LOSS ARISING OUT OF OR IN CONNECTION WITH THE ABILITY OR INABILITY TO USE THE PRODUCTS OR ACCESSORIES TO THE FULL EXTENT THESE DAMAGES MAY BE DISCLAIMED BY LAW.

Some jurisdictions do not allow the limitation or exclusion of incidental or consequential damages, or limitation on the length of an implied warranty, so the above limitations or exclusions may not apply to you. This Warranty gives you specific legal rights, and you may also have other rights that vary from one jurisdiction to another.



<b>Products Covered</b>	<b>Length of Coverage</b>
<b>Consumer Products</b>	<b>One (1) year</b> from the date of the products original purchase by the first consumer purchaser of the product.
<b>Consumer Accessories</b>	<b>Ninety (90) days</b> from the date of the accessories original purchase by the first consumer purchaser of the product.
<b>Consumer Products and Accessories that are Repaired or Replaced</b>	<b>The balance of the original warranty or for Ninety (90) days</b> from the date returned to the consumer, whichever is longer.

### **Exclusions**

**Normal Wear and Tear.** Periodic maintenance, repair and replacement of parts due to normal wear and tear are excluded from coverage.

**Batteries.** Only batteries whose fully charged capacity falls below 80% of their rated capacity and batteries that leak are covered by this Warranty.

**Abuse & Misuse.** Defects or damage that result from: (a) improper operation, storage, misuse or abuse, accident or neglect, such as physical damage (cracks, scratches, etc.) to the surface of the product resulting from misuse; (b) contact with liquid, water, rain, extreme humidity or heavy perspiration, sand, dirt or the like, extreme heat, or food; (c) use of the Products or Accessories for commercial purposes or subjecting the Product or Accessory to abnormal usage or conditions; or (d) other acts which are not the fault of MOTOROLA or BINATONE, are excluded from coverage.

**Use of Non-Motorola branded Products and Accessories.** Defects or damage that result from the use of Non-Motorola branded or certified Products or Accessories or other peripheral equipment are excluded from coverage.



**Unauthorized Service or Modification.** Defects or damages resulting from service, testing, adjustment, installation, maintenance, alteration, or modification in any way by someone other than MOTOROLA, BINATONE or its authorized service centers, are excluded from coverage.

**Altered Products.** Products or Accessories with (a) serial numbers or date tags that have been removed, altered or obliterated; (b) broken seals or that show evidence of tampering; (c) mismatched board serial numbers; or (d) nonconforming or non-Motorola branded housings, or parts, are excluded from coverage.

**Communication Services.** Defects, damages, or the failure of Products or Accessories due to any communication service or signal you may subscribe to or use with the Products or Accessories is excluded from coverage.

### ***How to Obtain Warranty Service or Other Information?***

To obtain service or information, please call:

US and Canada 1-888-331-3383

You will receive instructions on how to ship the Products or Accessories at your expense and risk, to a BINATONE Authorized Repair Center.

To obtain service, you must include: (a) the Product or Accessory; (b) the original proof of purchase (receipt) which includes the date, place and seller of the Product; (c) if a warranty card was included in your box, a completed warranty card showing the serial number of the Product; (d) a written description of the problem; and, most importantly; (e) your address and telephone number.

These terms and conditions constitute the complete warranty agreement between you and BINATONE regarding the Products or Accessories purchased by you, and supersede any prior agreement or representations, including representations made in any literature publications or promotional materials issued by BINATONE or representations made by any agent employee or staff of BINATONE, that may have been made in connection with the said purchase.



## FCC and IC regulations

### FCC Part 15

**NOTE:** This equipment has been tested and found to comply with the limits for a Class B digital device, pursuant to Part 15 of the Federal Communications Commission (FCC) rules. These limits are designed to provide reasonable protection against harmful interference in a residential installation. This equipment generates, uses and can radiate radio frequency energy and, if not installed and used in accordance with the instructions, may cause harmful interference to radio communications. However, there is no guarantee that interference will not occur in a particular installation. If this equipment does cause harmful interference to radio or television reception, which can be determined by turning the equipment off and on, the user is encouraged to try to correct the interference by one or more of the following measures:

- Reorient or relocate the receiving antenna.
  - Increase the separation between the equipment and receiver.
  - Connect the equipment into an outlet on a circuit different from that to which the receiver is connected.
  - Consult the dealer or an experienced radio/TV technician for help.
- Changes or modifications to this equipment not expressly approved by the party responsible for compliance could void the user's authority to operate the equipment.

This device complies with Part 15 of the FCC rules. Operation is subject to the following two conditions: (1) this device may not cause harmful interference, and (2) this device must accept any interference received, including interference that may cause undesired operation. Privacy of communications may not be ensured when using this device.

To ensure safety of users, the FCC has established criteria for the amount of radio frequency energy that can be safely absorbed by a user or bystander according to the intended usage of the product. This product has been tested and found to comply with the FCC criteria. The Indoor Pet Unit shall be installed and used such that parts of the user's body other than the hands are maintained at a distance of approximately 20 cm (8 inches) or more.

This Class B digital apparatus complies with Canadian ICES-003.

## **WARNING**

Changes or modifications, to this equipment not expressly approved by the party responsible for compliance could void the user's authority to operate the equipment.

### **Industry Canada**

This device complies with Industry Canada licence-exempt RSS standard(s): Operation is subject to the following Two conditions:

(1) this device may not cause interference, and (2) this device must accept any interference, including interference that may cause undesired operation of the device.

The term "IC:" before the certification/registration number only signifies that the Industry Canada technical specifications were met. This product meets the applicable Industry Canada technical specifications.

Le présent appareil est conforme aux CNR d'Industrie Canada applicables aux appareils radio exempts de licence. L'exploitation est autorisée aux deux conditions suivantes : (1) l'appareil ne doit pas produire de brouillage, et (2) l'utilisateur de l'appareil doit accepter tout brouillage radioélectrique subi, même si le brouillage est susceptible d'en compromettre le fonctionnement.

**Technical Specifications****Indoor Pet Unit (Model: SCOUT1000PU)**

Frequency	2.4GHz to 2.48GHz
Image sensor	Color CMOS 0.3M Pixels
Lens	f 2.5mm, F 1.8
IR LED	8 pcs
Power	Adapter: BLJ5W059100P; Input: 100-240V, 50/60Hz 150mA; Output: 5.9V, 1000mA
	<b>WARNING</b> <i>Use only with provided power supply.</i>

**Outdoor Pet Unit (Model: SCOUT1100PU)**

Frequency	2.4GHz to 2.48GHz
Image sensor	Color CMOS 0.3M Pixels
Lens	f 2.5mm, F 2.0
IR LED	8 pcs
Power	Adapter: BLJ5W059100P; Input: 100-240V, 50/60Hz 150mA; Output: 5.9V, 1000mA
	<b>WARNING</b> <i>Use only with provided power supply.</i>





---

**Owner unit (Model: SCOUT1000MU)**

---

Frequency 2.4GHz to 2.48GHz

Display 3.5" diagonal TFT LCD

Display color 16.7M color LCD

Brightness control 8 steps

Volume control 8 steps

---

Power Adapter: BLJ5W060050P; Input: 100-240V, 50/60Hz 150mA; Output: 6.0V, 500mA

**WARNING**

*Use only with provided power supply.*

OR

Battery: Model - DESAY, Ni-MH AAA 3 x 1.2V 900mAh rechargeable battery pack

**WARNING**

*Do not use non-rechargeable batteries for the Owner Unit. Risk of explosion if battery is replaced by an incorrect type. Dispose of used batteries according to the instructions.*

---



**MOTOROLA**

Manufactured, distributed or sold by Binatone Electronics International LTD., official licensee for this product. MOTOROLA and the Stylized M Logo, are trademarks or registered trademarks of Motorola Trademark Holdings, LLC. and are used under license. All other trademarks are the property of their respective owners.

© 2013 Motorola Mobility LLC. All rights reserved.

Version 4.0

Printed in China

