

TEST REPORT

For

Mobile Phone

In conformity with

**FCC Part24 (Oct 01,2007)
IC RSS-133 Issue4**

Model: F-06A

Test Item: Mobile Phone

Report No: RY0810P17R6

Issue Date: Oct. 17, 2008

Prepared for

Fujitsu Limited.
1-1, Kamikodanaka 4-chome, Nakahara-ku, Kawasaki 211-8588,
Japan

Prepared by

RF Technologies Ltd.
472, Nippa-cho, Kohoku-ku, Yokohama, 223-0057, Japan
Telephone: +81+(0)45- 534-0645
FAX: +81+(0)45- 534-0646

This report shall not be reproduced, except in full, without the written permission of RF Technologies Ltd. The test results relate only to the sample(s) tested. RF Technologies Ltd. is managed to ISO17025 and has the necessary knowledge and test facilities for testing according to the referenced standards.

Table of Contents

1	General information	3
1.1	Product description	3
1.2	Test(s) performed/ Summary of test result	3
1.3	Test facility	4
1.4	Measurement uncertainty	4
1.5	Description of essential requirements and test results.....	5
1.5.1	Transmitter requirements	5
1.5.2	Receiver requirements.....	5
1.5.3	AC Power Line Parameters.....	5
1.5.4	Normal test conditions	5
1.5.5	Extreme test conditions.....	5
1.6	Setup of equipment under test (EUT)	6
1.6.1	Test configuration of EUT	6
1.6.2	Operating condition:	6
1.6.3	Setup diagram of tested system:.....	7
1.7	Equipment modifications	7
1.8	Deviation from the standard.....	7
2	Test procedure and result.....	8
2.1	Transmitter requirements	8
2.1.1	Carrier Output Power (Conducted).....	8
2.1.2	Carrier Output Power (Radiated)	10
2.1.3	Frequency Stability (Temperature)	13
2.1.4	Frequency Stability (Voltage).....	15
2.1.5	Occupied Bandwidth.....	17
2.1.6	Transmitter Out of Band Spurious Emissions (Conducted).....	22
2.1.7	Transmitter Out of Band Spurious Emissions (Radiated).....	28
2.1.8	Band Edge Emissions.....	32
2.1.9	Transmitter AC Power Line Emission requirement.....	35
2.2	Receiver requirement	37
2.2.1	Receiver Spurious Emissions (Radiated).....	37
2.2.2	Receiver AC Power Line Emission requirement	40
3	Test setup photographs.....	42
4	List of utilized test equipment/ calibration.....	45

1 General information

1.1 Product description

Test item : Mobile phone
Manufacturer : Fujitsu Limited
Address : 1-1, Kamikodanaka 4-chome, Nakahara-ku, Kawasaki
211-8588, Japan
Model : F-06A
FCC ID : VQK-F-06A
IC Certification No. : 337E-F06A
Operating frequency range : TX 1850.2-1909.8 MHz (PCS1900)
: RX 1930.2-1989.8 MHz (PCS1900)
Type of Modulation : GMSK
Receipt date of EUT : Oct 03 2008
Nominal power voltages : 3.7 VDC (Lithium-ion battery)
Power Class : 1 (Maximum power 30dBm nominal)
Antenna Type : integral antenna
Serial numbers : 357016011106353

1.2 Test(s) performed/ Summary of test result

Applicable Standard(s) : FCC Part24(Oct 01,2007)
RSS-133 Issue4
Test(s) started : Oct 07, 2008
Test(s) completed : Oct 15, 2008
Purpose of test(s) : Grant for Certification of FCC / IC
Summary of test result : Complied

Note: The above judgment is only based on the measurement data and it does not include the measurement uncertainty. Accordingly, the statement below is applied to the test result. The EUT complies with the limit required in the standard in case that the margin is not less than the measurement uncertainty in the Laboratory. Compliance of the EUT is more probable than non-compliance is case that the margin is less than the measurement uncertainty in the Laboratory.

Test engineer : 
T. Kato (EMC testing department)

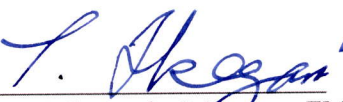
Reviewer : 
T. Ikegami (Manager, EMC testing department)

1.3 Test facility

The Federal Communications Commission has reviewed the technical characteristics of the test facilities at RF Technologies Ltd., located in 472, Nippa-cho, Kohoku-ku, Yokohama, 223-0057, Japan, and has found these test facilities to be in compliance with the requirements of 47 CFR Part 15, section 2.948, per October 01, 2007.

The description of the test facilities has been filed under registration number 879401 at the Office of the Federal Communications Commission. The facility has been added to the list of laboratories performing these test services for the public on a fee basis.

The list of all public test facilities is available on the Internet at <http://www.fcc.gov>.

Registered by Voluntary Control Council for Interference by Information Technology Equipment (VCCI).

Each registered facility number is as follows;

Test site (Semi-anechoic chamber 3m) R-2393

Test site (Shielded room) C-2617

Registered by Industry Canada (IC). The registered facility number is as follows;

Test site No.1(Semi-anechoic chamber 3m) : 6974A-1

1.4 Measurement uncertainty

The treatment of uncertainty is based on the general matters on the definition of uncertainty in “Guide to the expression of uncertainty in measurement (GUM)” published by ISO. The Lab’s uncertainty is determined by referring UKAS Publication LAB34: 2002 “The Expression of Uncertainty in EMC Testing” and CISPR16-4-2: 2003 “Uncertainty in EMC Measurements”.

The uncertainty of the measurement result in the level of confidence of approximately 95% (k=2) is as follows;

RF frequency: $\pm 1 \times 10^{-7}$

RF power conducted: ± 1.0 dB

AC power line emission: ± 1.9 dB

Radiated emission (30 MHz - 1000 MHz): ± 5.7 dB

Radiated emission (1 GHz - 20 GHz): ± 5.8 dB

Temperature: ± 1 degree

Humidity: ± 5 %

1.5 Description of essential requirements and test results

An overview of radio requirements, as laid out in FCC Part24/15, RSS-133 are given below.

1.5.1 Transmitter requirements

Test Description	Section in this report	Applicable	Result
Carrier Output Power (Conducted)	2.1.1	Yes	Passed
Carrier Output Power (Radiated)	2.1.2	Yes	Passed
Frequency Stability (Temperature Variation)	2.1.3	Yes	Passed
Frequency Stability (Voltage Variation)	2.1.4	Yes	Passed
Occupied Bandwidth	2.1.5	Yes	Passed
Out of Band Emissions (Conducted)	2.1.6	Yes	Passed
Out of Band Emissions (Radiated)	2.1.7	Yes	Passed
Band Edge Emissions	2.1.8	Yes	Passed

1.5.2 Receiver requirements

Test Description	Section in this report	Applicable	Result
Spurious Radiated Emissions	2.2.1	Yes	Passed

1.5.3 AC Power Line Parameters

Test Description	Section in this report	Applicable	Result
AC power line Spurious Emissions (Idle mode)	2.3.1	Yes	Passed
AC power line Spurious Emissions (Traffic mode)	2.3.2	Yes	Passed

1.5.4 Normal test conditions

Temperature(*) : +15 degC to +35 degC
 Relative humidity(*) : 20 % to 75 %
 Supply voltage : 3.7 VDC (Nominal)
 Measurement Frequency : 1850.2 MHz(512ch),1880.0 MHz(661ch),1909.8 MHz(810ch)

* When it is impracticable to carry out tests under these conditions, a note to this effect, stating the ambient temperature and relative humidity during the tests, must be stated separately.

1.5.5 Extreme test conditions

Temperature : -30 °C (min) to +50 °C (max)
 Supply voltage : 3.33 VDC (min) to 4.07 VDC (max)

The equipment has a function that it is automatically turned off when min. battery voltage (3.33 V) is detected.

1.6 Setup of equipment under test (EUT)

1.6.1 Test configuration of EUT

Equipment(s) under test:

	Item	Manufacturer	Model No.	Serial No.	FCC ID/ IC Certification No.
A	Mobile phone	Fujitsu Limited	F-06A	357016011106353	VQK-F-06A / 337E-F06A
B	Battery pack	Fujitsu Limited	CA54310-0006	None	N/A
C	AC Adaptor	NEC Corp.	MAS-BH0008-A002	None	N/A
D	Earphone	NTT DOCOMO, INC.	P02	None	N/A

Connected cable(s):

No.	Item	Identification (Manu.e.t.c)	Shielded YES / NO	Ferrite Core YES / NO	Connector Type Shielded YES / NO	Length (m)
1	DC power cable	-	No	No	No	1.5
2	AC power cable	HEWTECH	No	No	No	0.6
3	Earphone cable	-	No	No	No	1.4

1.6.2 Operating condition:

- Traffic mode : EUT is connected with RF tester in Max power level. (Normal and GPRS mode)
 Idle mode : EUT is under idle mode, no output power is transmitted.

1.6.3 Setup diagram of tested system:

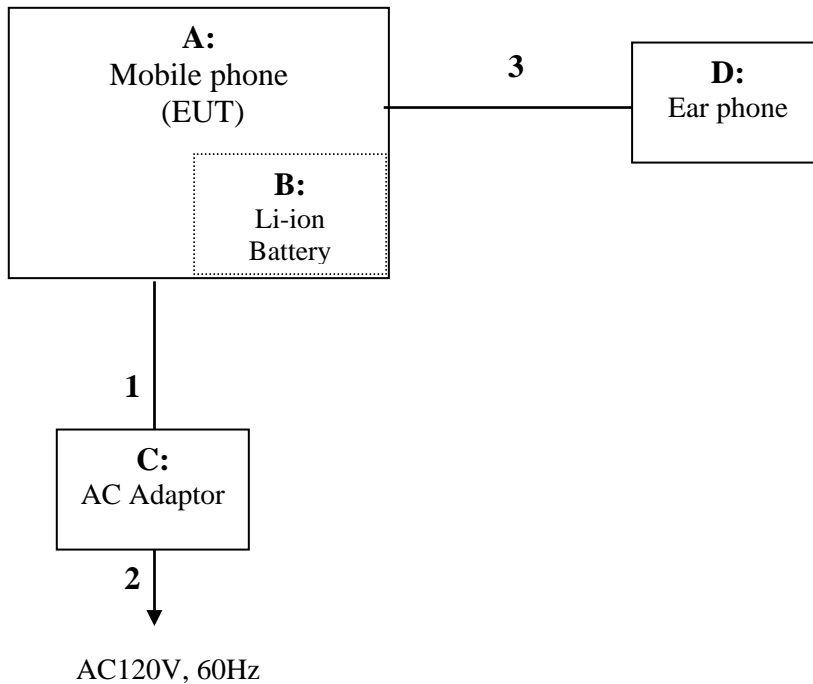

1.7 Equipment modifications

No modifications have been made to the equipment in order to achieve compliance with the applicable standards described in clause 1.2.

1.8 Deviation from the standard

No deviations from the standards described in clause 1.2.

2 Test procedure and result

2.1 Transmitter requirements

2.1.1 Carrier Output Power (Conducted)

Reference Standard

FCC : Part24.232, 2.0146

IC : RSS133 Issue4 Sec6.4, SRSP-510 Issue4 Sec5.1.2

Test Conditions

Date: 2008/10/14

Ambient Temperature: 20 degC

Relative humidity: 67 %

Test Voltage: 3.7 V

Test Method

- a) EUT is connected to RF tester with pseudo random data modulation and set to maximum output power level.
- b) The output power is measured with RF tester (CMU200 etc.).

Test Setup

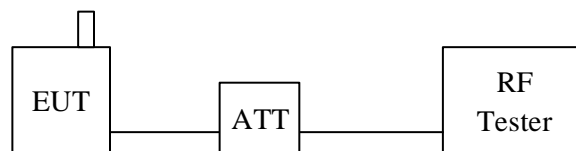

Test Results

Channel	Frequency (MHz)	Output Power (dBm)		Limit (dBm)	Result
		Normal	GPRS		
Bottom (512ch)	1850.2	29.4	29.4	33.0	Pass
Middle (661ch)	1880.0	29.4	29.4	33.0	Pass
Top (810ch)	1909.8	29.1	29.1	33.0	Pass

Test Equipment Used

Equipment name	RFT ID No.
RF tester	RC03

Final Result

The EUT met the requirements of the standard for this test.

EUT can employ a power control function that output power can be controlled from +30dBm to +0dBm (nominal) by 2dB step. So EUT meet the requirement of Part24.232(c).

2.1.2 Carrier Output Power (Radiated)

Reference Standard

FCC : Part24.232, 2.0146

IC : RSS133 Issue4 Sec6.4, SRSP-510 Issue4 Sec5.1.2

Test Conditions

Date: 2008/10/07

Ambient Temperature: 20 degC

Relative humidity: 71 %

Test Voltage: 3.7 V

Test Method

Substitution method is used for this test.

a) EUT is set on non-conducting turntable and the output power is set to the maximum level.

b) As a receive antenna, Horn antenna is used for high frequency range (above 1GHz), and Biological antenna is used for low frequency range (30MHz to 1GHz).

c) Maximum power is measured by a spectrum analyzer(SA) in below conditions.

Turntable is rotated 360 degrees.

The height of receive antenna is changed from 1m to 4m.

Receive antenna polarization is set to vertical and horizontal.

This maximum power is recorded.

During this measurement, receive antenna is adjusted the direction to keep the EUT within the beamwidth of receive antenna.

d) Reference antenna is replaced with EUT, and connected with signal generator(SG).

SG output power is adjusted to get same level as the recorded maximum radiated EUT power by SA.

e) Radiated output power (Pout) is calculated with adjusted SG output (Psg) [dBm], reference antenna gain (Gref) [dBi] and cable loss between SG and reference antenna (Lcab) [dB].

$$P_{out} [\text{dBm e.i.r.p}] = P_{sg} + G_{ref} + L_{cab}$$

Test Setup

[Measurement]

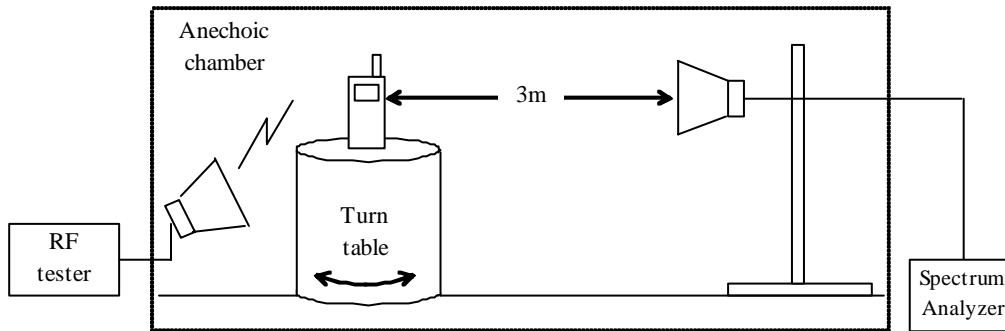

[Substitution]

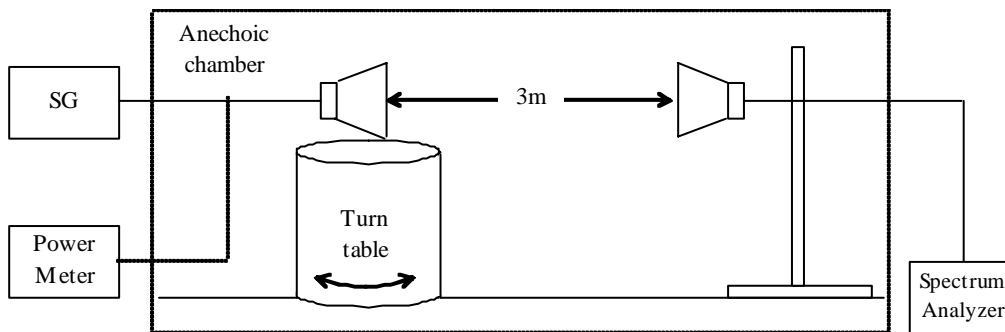

Test Results

Channel	Frequency (MHz)	Output Power (dBm e.i.r.p)	Limit (dBm e.i.r.p)	Result
Bottom (512ch)	1850.2	29.2	33.0	Pass
Middle (661ch)	1880.0	29.7	33.0	Pass
Top (810ch)	1909.8	29.7	33.0	Pass

Test Equipment Used

Equipment name	RFT ID No.
Spectrum Analyzer	TR06
Receive Antenna	DH02
Reference Antenna	DH01
Signal Generator	SG05
Power Meter	PM01
RF tester	RC03

Final Result

The EUT met the requirements of the standard for this test.

2.1.3 Frequency Stability (Temperature)

Reference Standard

FCC : Part24.235, 2.1055

IC : RSS133 Issue4 Sec6.3

Test Conditions

Date: 2008/10/14

Ambient Temperature: 20 degC

Relative humidity: 67 %

Test Voltage: 3.7 V

Test Method

To measure the carrier frequency, “Frequency error measurement” function of RF tester is used.

- a) EUT is hold about 30 minutes under measurement temperature condition.
- b) EUT is powered on with nominal voltage.
- c) EUT is connected to RF tester with Max transmit power level.
- d) Frequency error is measured by RF tester.

Process b) to d) must be finished within 2 minutes to prevent EUT warming.

- e) Process a) to d) is repeated at 10deg increments from -30 to +50degC.

Test Setup

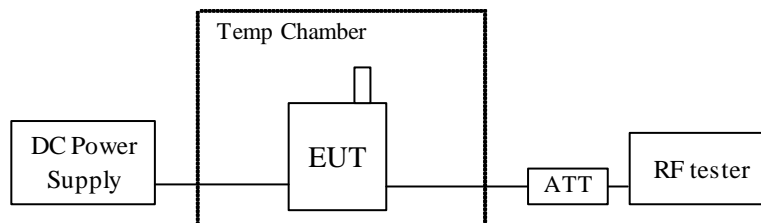

Test Results**Bottom Channel (512ch, Nominal Freq.:1850.2MHz)**

Temperature (deg C)	Frequency Error (Hz)	Frequency Error (ppm)	Limit (ppm)	Result
-30	28	0.02	± 2.5	Passed
-20	30	0.02	± 2.5	Passed
-10	34	0.02	± 2.5	Passed
0	33	0.02	± 2.5	Passed
10	30	0.02	± 2.5	Passed
20	25	0.01	± 2.5	Passed
30	29	0.02	± 2.5	Passed
40	30	0.02	± 2.5	Passed
50	28	0.02	± 2.5	Passed

Test Equipment Used

Equipment name	RFT ID No.
RF tester	RC03

Final Result

The EUT met the requirements of the standard for this test

2.1.4 Frequency Stability (Voltage)

Reference Standard

FCC : Part24.235, 2.1055

IC : RSS133 Issue4 Sec6.3

Test Conditions

Date: 2008/10/14
Ambient Temperature: 20 degC
Relative humidity: 67 %
Test Voltage: 3.33 to 4.07 V

Test Method

To measure the carrier frequency, “Frequency error measurement” function of RF tester is used.

- a) EUT is powered on with nominal voltage. Temperature is 20degC.
- b) EUT is connected to RF tester with Max transmitter power level.
- c) Frequency error is measured by RF tester.
- d) Process a) to c) is repeated at minimum and maximum voltage condition.

Test Setup

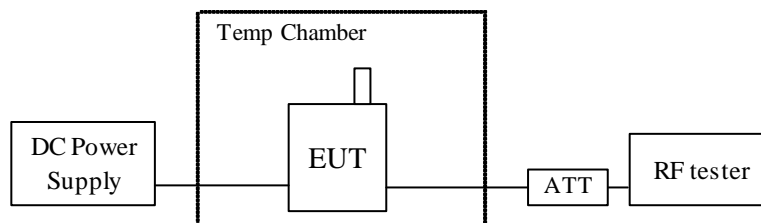

Test Results**Bottom Channel (512ch, Nominal Freq.:1850.2MHz)**

Voltage (V)	Frequency Error (Hz)	Frequency Error (ppm)	Limit (ppm)	Result
3.33	33	0.02	± 2.5	Passed
3.70	25	0.01	± 2.5	Passed
4.07	26	0.01	± 2.5	Passed

Test Equipment Used

Equipment name	RFT ID No.
RF tester	RC03

Final Result

The EUT met the requirements of the standard for this test

2.1.5 Occupied Bandwidth

Reference Standard

FCC : Part24.238

IC : RSS-Gen Issue2 Sec4.6.1

Test Conditions

Date: 2008/10/14

Ambient Temperature: 20 degC

Relative humidity: 67 %

Test Voltage: 3.7 V

Test Method

- a) EUT is connected to RF tester with Max transmitter power level.
- b) 26dB bandwidth is measured by Spectrum Analyzer.
- c) 99% occupied bandwidth of transmitter spectrum is measured by Spectrum Analyzer.

Test Setup

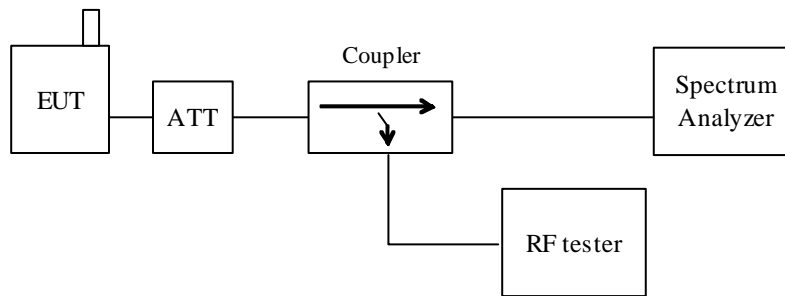

Test Results

Channel	Frequency (MHz)	Resolution Bandwidth (kHz)	Video Bandwidth (kHz)	Occupied Bandwidth (kHz)	26dB Bandwidth (kHz)
Bottom (512ch)	1850.2	3kHz	10kHz	246	306
Middle (661ch)	1880.0	3kHz	10kHz	244	316
Top (810ch)	1909.8	3kHz	10kHz	242	308

Graphical Data

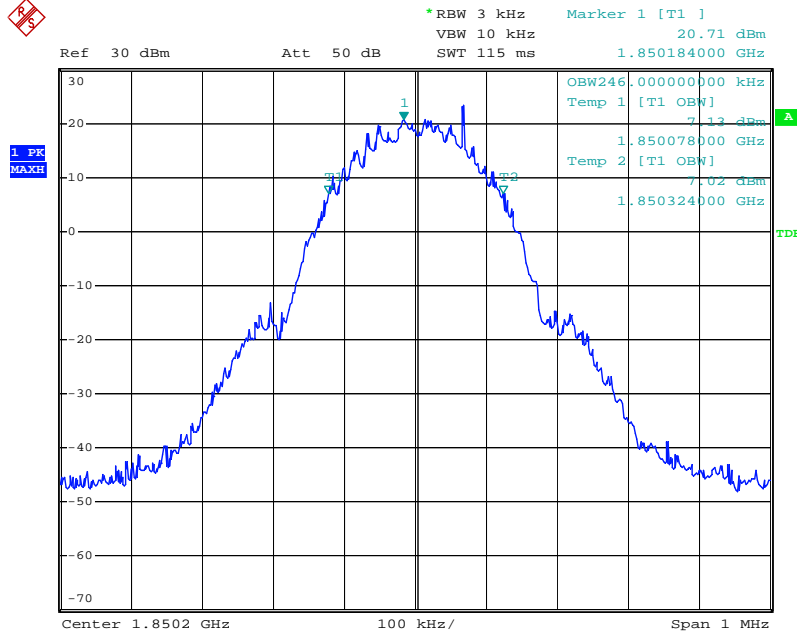

512ch Occupied Bandwidth

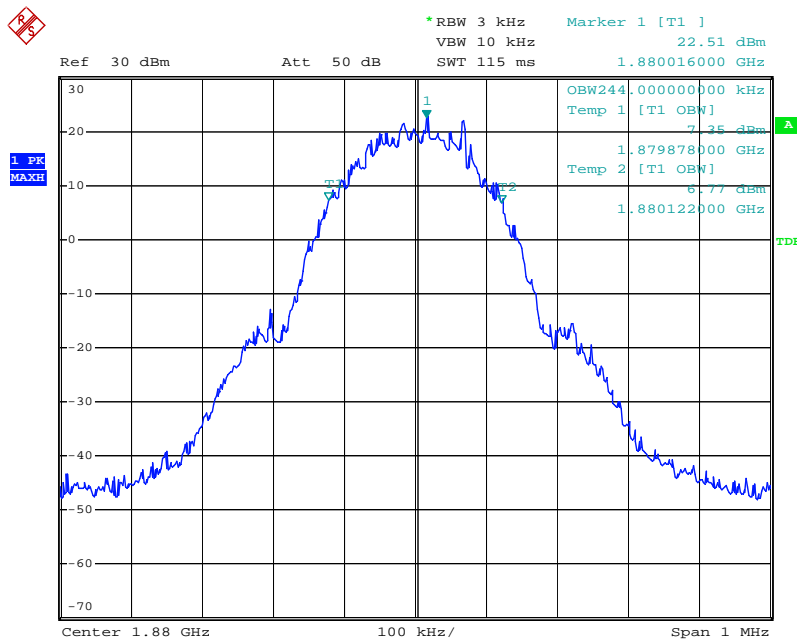

661ch Occupied Bandwidth

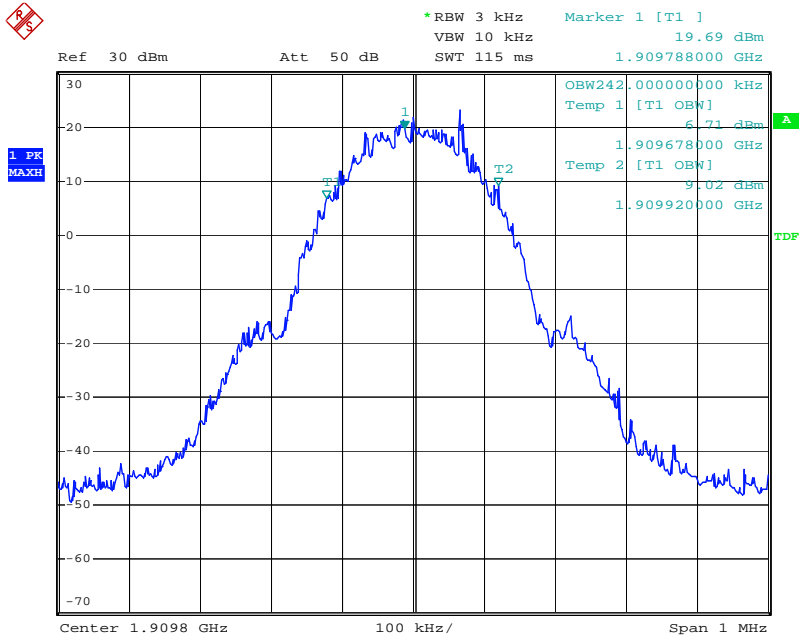

810ch Occupied Bandwidth

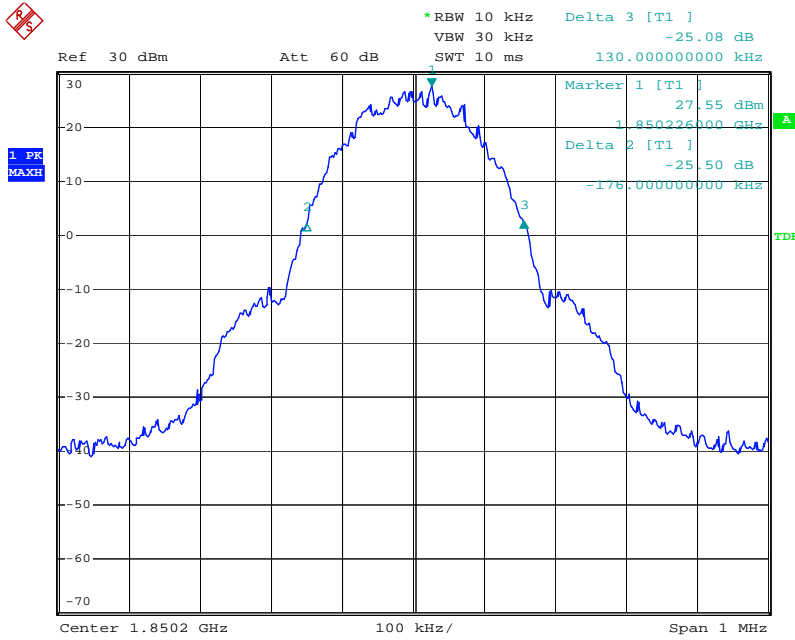

512ch 26dB Bandwidth

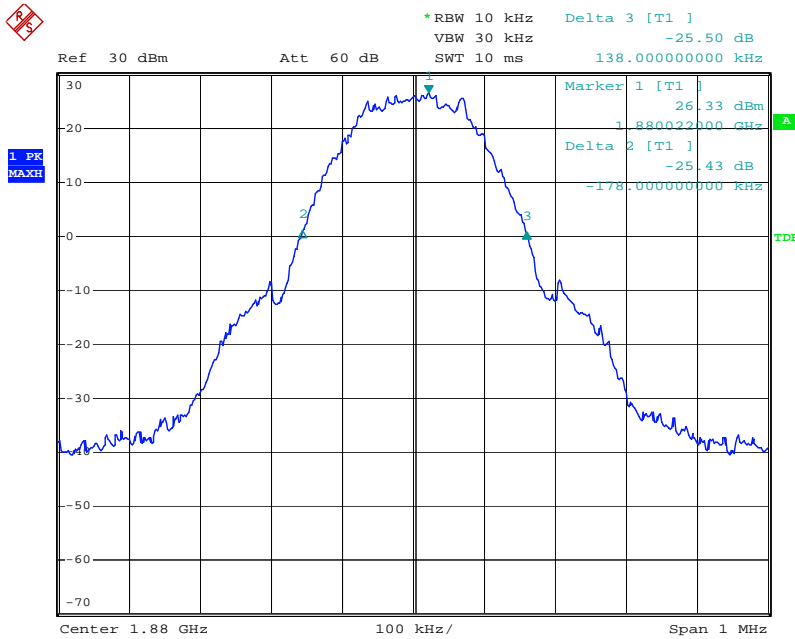

661ch 26dB Bandwidth

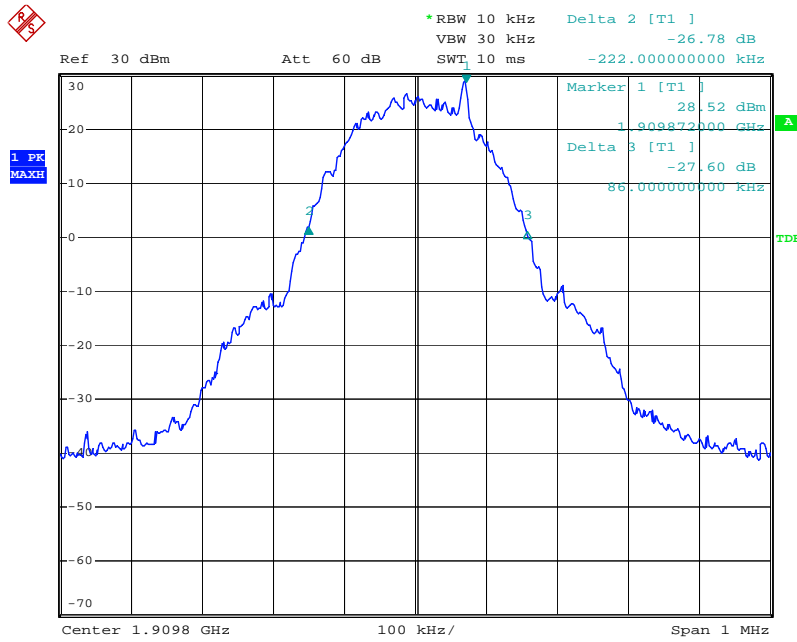

810ch 26dB Bandwidth

Test Equipment Used

Equipment name	RFT ID No.
Spectrum Analyzer	TR06
RF tester	RC03

2.1.6 Transmitter Out of Band Spurious Emissions (Conducted)

Reference Standard

FCC : Part24.238

IC : RSS133 Issue4 Sec6.5

Test Conditions

Date: 2008/10/14

Ambient Temperature: 20 degC

Relative humidity: 67 %

Test Voltage: 3.7 V

Test Method

- EUT is connected to RF tester with Max transmitter power level.
- Out of band Spurious is measured by Spectrum Analyzer.
- Resolution band width of spectrum analyzer is set to 1MHz (above 1GHz) or 100kHz (below 1GHz).

Test Setup

30MHz to 3500MHz

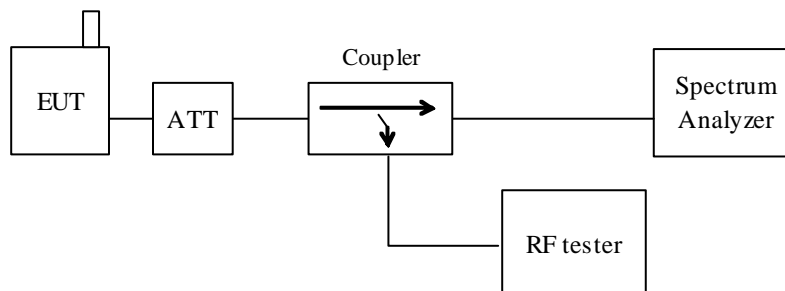

above 3500MHz

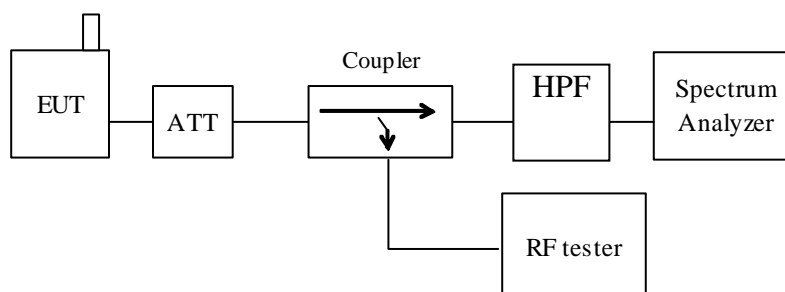

Test Results

Bottom Channel (512ch, Nominal Freq.:1850.2MHz)

Measurement Frequency (MHz)	Measurement Bandwidth (MHz)	Emission Level (dBm)	Limit (dBm)	Result Pass/Fail
3700.4	1	-52.1	-13.0	Pass
5550.6	1	-46.8	-13.0	Pass
7400.8	1	< -60.0	-13.0	Pass
9251.0	1	-57.1	-13.0	Pass
11101.2	1	< -60.0	-13.0	Pass
12951.4	1	< -60.0	-13.0	Pass
14801.6	1	< -50.0	-13.0	Pass
16651.8	1	< -50.0	-13.0	Pass
18502.0	1	< -50.0	-13.0	Pass
others		-	-13.0	Pass

Middle Channel (661ch, Nominal Freq.:1880.0MHz)

Measurement Frequency (MHz)	Measurement Bandwidth (MHz)	Emission Level (dBm)	Limit (dBm)	Result Pass/Fail
3760.0	1	-51.8	-13.0	Pass
5640.0	1	-47.2	-13.0	Pass
7520.0	1	< -60.0	-13.0	Pass
9400.0	1	-56.1	-13.0	Pass
11280.0	1	-57.5	-13.0	Pass
13160.0	1	< -60.0	-13.0	Pass
15040.0	1	< -50.0	-13.0	Pass
16920.0	1	< -50.0	-13.0	Pass
18800.0	1	< -50.0	-13.0	Pass
others		-	-13.0	Pass

Top Channel (810ch, Nominal Freq.:1909.8MHz)

Measurement Frequency (MHz)	Measurement Bandwidth (MHz)	Emission Level (dBm)	Limit (dBm)	Result Pass/Fail
3819.6	1	-50.6	-13.0	Pass
5729.4	1	-46.3	-13.0	Pass
7639.2	1	< -60.0	-13.0	Pass
9549.0	1	< -60.0	-13.0	Pass
11458.8	1	-52.1	-13.0	Pass
13368.6	1	< -60.0	-13.0	Pass
15278.4	1	< -50.0	-13.0	Pass
17188.2	1	< -50.0	-13.0	Pass
19098.0	1	< -50.0	-13.0	Pass
others		-	-13.0	Pass

Graphical Data (661ch)

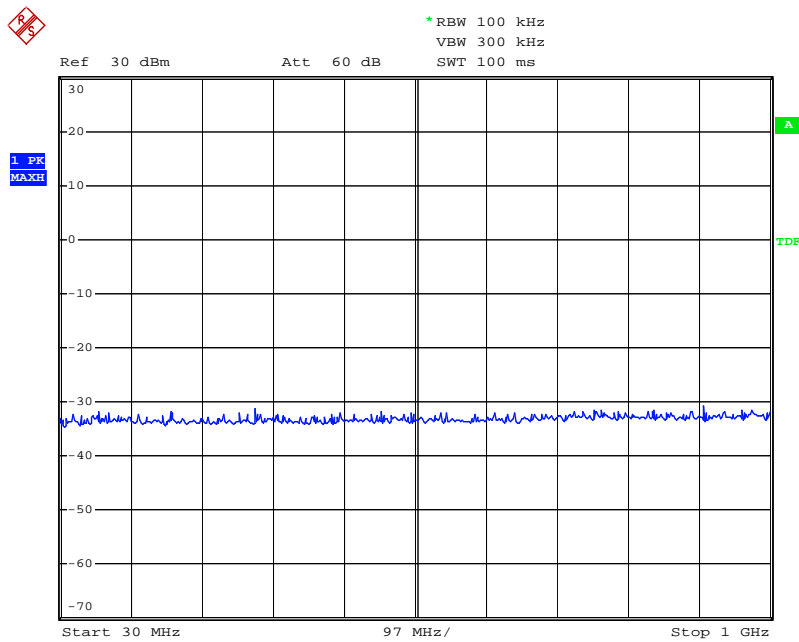

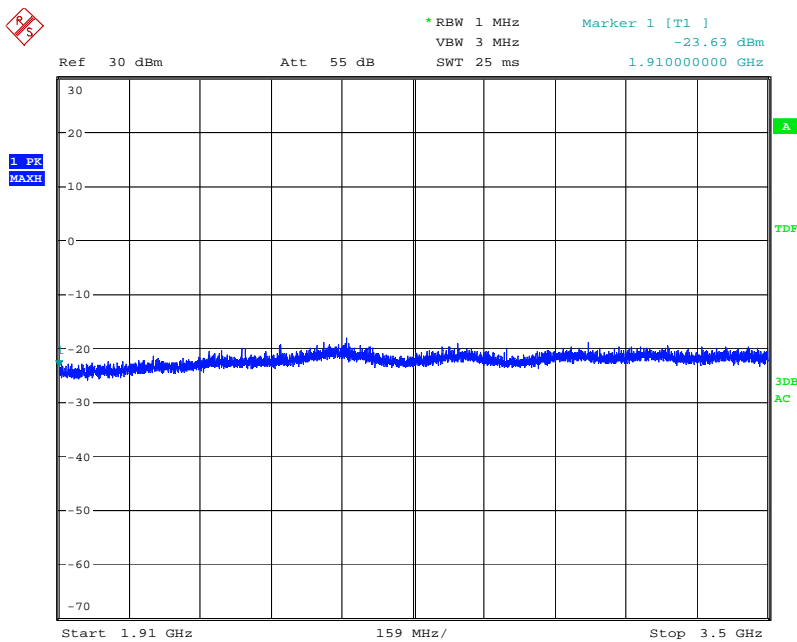
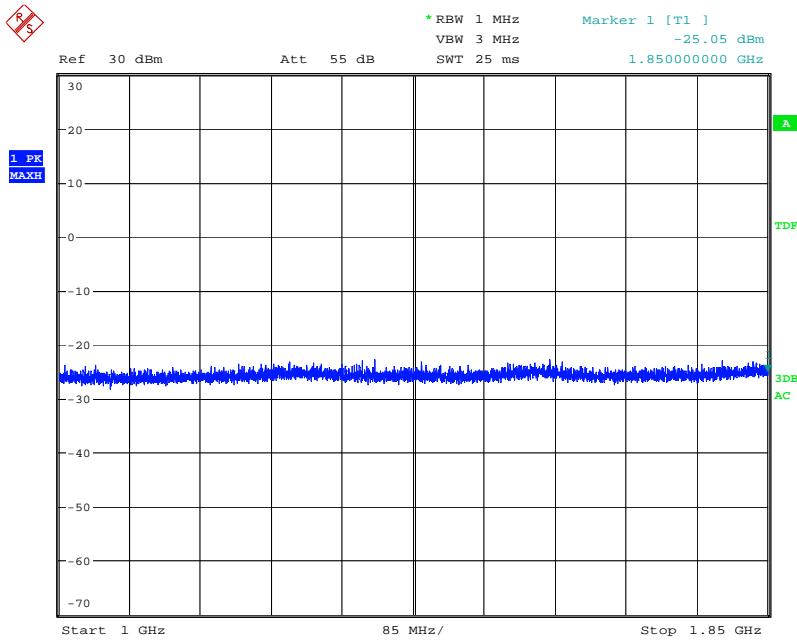

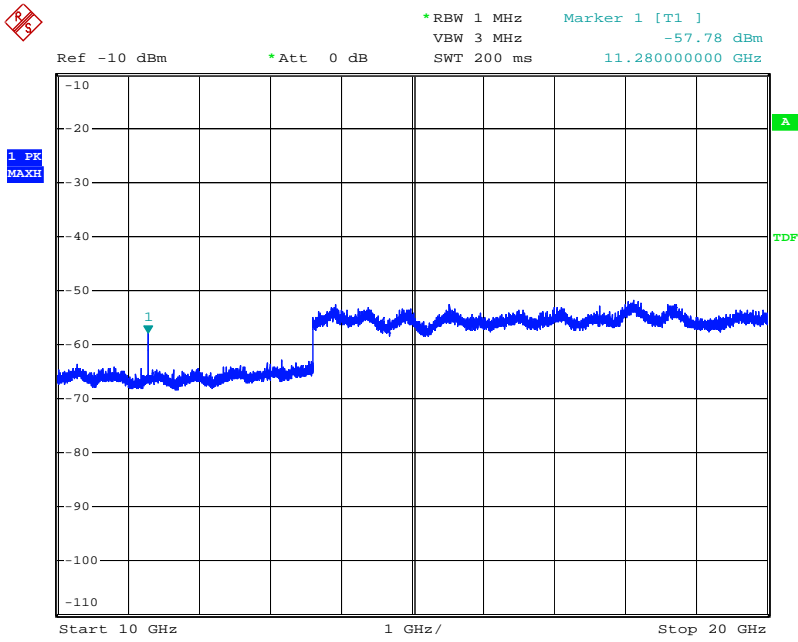
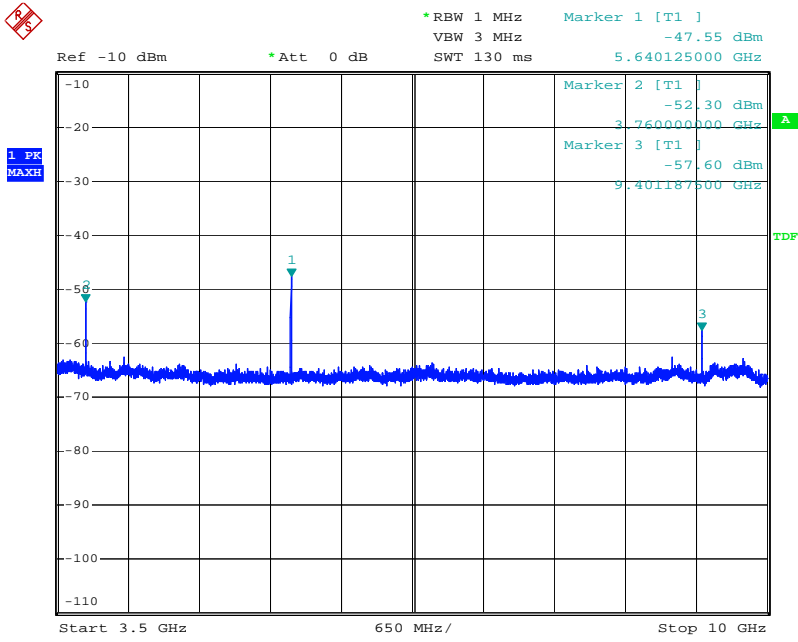

Test Equipment Used

Equipment name	RFT ID No.
Spectrum Analyzer	TR06
RF tester	RC03

Final Result

The EUT met the requirements of the standard for this test.

2.1.7 Transmitter Out of Band Spurious Emissions (Radiated)

Reference Standard

FCC : Part24.238

IC : RSS133 Issue4 Sec6.5

Test Conditions

Date: 2008/10/07

Ambient Temperature: 20 degC

Relative humidity: 71 %

Test Voltage: 3.7 V

Test Method

Substitution method is used for this test.

- a) EUT is set on non-conducting turntable and the output power is set to the maximum level.
- b) As a receive antenna, Horn antenna is used for high frequency range (above 1GHz), and Bilogical antenna is used for low frequency range (30MHz to 1GHz).
- c) The maximum level of each spurious emission is measured by a spectrum analyzer(SA) in below conditions.

Turntable is rotated 360 degrees.

The height of receive antenna is changed from 1m to 4m.

Receive antenna polarization is set to vertical and horizontal.

EUT was placed at three different orientations (X, Y and Z axis) in order to find the worst orientation.

This emission level is recorded.

During this measurement, receive antenna is adjusted the direction to keep the EUT within the beamwidth of receive antenna.

- d) Reference antenna is replaced with EUT, and connected with signal generator(SG).
SG output power is adjusted to get same level as the recorded maximum radiated EUT power by SA.
- e) Radiated output power (Pout) is calculated with adjusted SG output (Psg) [dBm], reference antenna gain (Gref) [dBd] and cable loss between SG and reference antenna (Lcab) [dB].

$$Pout \text{ [dBm e.r.p]} = Psg + Gref + Lcab$$

Test Setup

[Measurement]

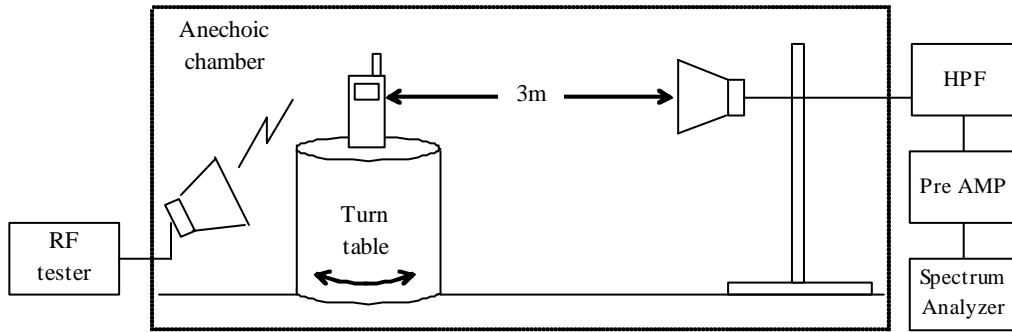

[Substitution]

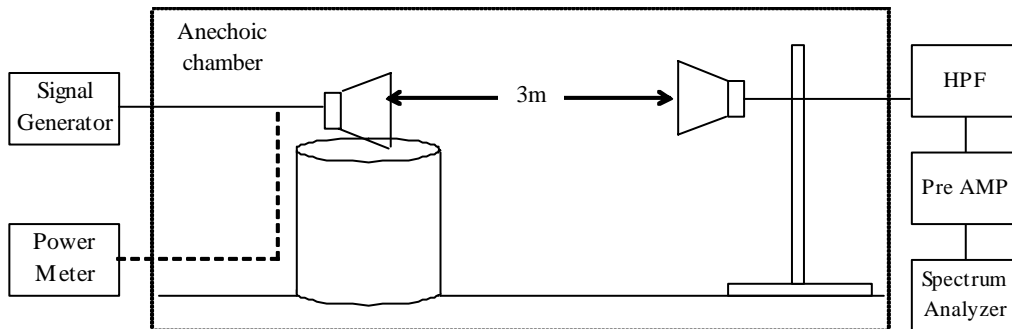

Test Results

Bottom Channel (512ch, Nominal Freq.:1850.2MHz)

Measurement Frequency (MHz)	Measurement Bandwidth (MHz)	Emission Level(dBm)		Limit (dBm)	Result Pass/Fail
		Vertical	Horizontal		
3700.4	1	-39.6	-40.8	-13.0	Pass
5550.6	1	-18.0	-17.2	-13.0	Pass
7400.8	1	-42.8	-43.1	-13.0	Pass
9251.0	1	-31.5	-30.5	-13.0	Pass
11101.2	1	-31.0	-38.7	-13.0	Pass
12951.4	1	-36.1	-36.3	-13.0	Pass
14801.6	1	-38.0	< -37.9	-13.0	Pass
16651.8	1	< -36.7	< -37.0	-13.0	Pass
18502.0	1	< -27.7	< -28.0	-13.0	Pass
others		-	-	-13.0	Pass

Middle Channel (661ch, Nominal Freq.:1880.0MHz)

Measurement Frequency (MHz)	Measurement Bandwidth (MHz)	Emission Level(dBm)		Limit (dBm)	Result Pass/Fail
		Vertical	Horizontal		
3760.0	1	-38.3	-38.7	-13.0	Pass
5640.0	1	-17.4	-16.8	-13.0	Pass
7520.0	1	-41.4	-42.8	-13.0	Pass
9400.0	1	-28.8	-27.4	-13.0	Pass
11280.0	1	-36.6	-35.8	-13.0	Pass
13160.0	1	-32.6	-32.5	-13.0	Pass
15040.0	1	-36.8	-36.5	-13.0	Pass
16920.0	1	< -35.7	< -35.8	-13.0	Pass
18800.0	1	< -22.1	< -22.3	-13.0	Pass
others		-	-	-13.0	Pass

Top Channel (810ch, Nominal Freq.:1909.8MHz)

Measurement Frequency (MHz)	Measurement Bandwidth (MHz)	Emission Level(dBm)		Limit (dBm)	Result Pass/Fail
		Vertical	Horizontal		
3819.6	1	-36.7	-36.5	-13.0	Pass
5729.4	1	-17.4	-18.9	-13.0	Pass
7639.2	1	-42.2	-42.1	-13.0	Pass
9549.0	1	-27.9	-26.3	-13.0	Pass
11458.8	1	-34.1	-32.7	-13.0	Pass
13368.6	1	-30.9	-31.3	-13.0	Pass
15278.4	1	-36.2	-37.5	-13.0	Pass
17188.2	1	< -35.0	< -35.0	-13.0	Pass
19098.0	1	< -24.4	< -24.7	-13.0	Pass
others		-	-	-13.0	Pass

Test Equipment Used

Equipment name	RFT ID No.
Spectrum Analyzer	TR06
Receive Antenna	DH02, SH02
Reference Antenna	DH01, SH01
Signal Generator	SG05
Power Meter	PM01
RF tester	RC03

Final Result

The EUT met the requirements of the standard for this test.

2.1.8 Band Edge Emissions

Reference Standard

FCC : Part24.238

IC : RSS133 Issue4 Sec6.5

Test Conditions

Date: 2008/10/14

Ambient Temperature: 20 degC

Relative humidity: 67 %

Test Voltage: 3.7 V

Test Method

- a) EUT is connected to RF tester with Max transmitter power level.
- b) Lower band edge level is measured in bottom channel transmission.
- c) Higher band edge level is measured in top channel transmission.
- d) 1% of band width is used for resolution band width for spectrum analyzer.

Test Setup

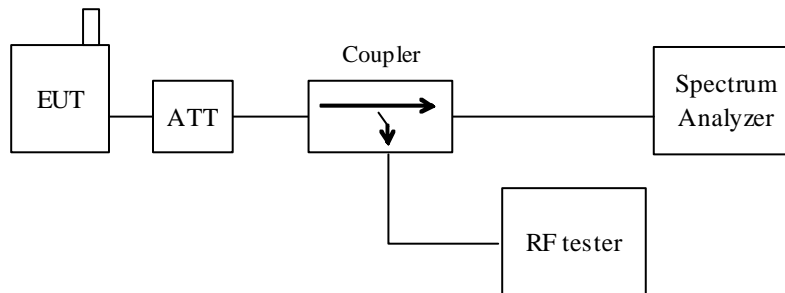

Test Results

Bottom Band Edge

Measured Frequency (MHz)	Peak Level (dBm)	Limit (dBm)	Result
1850.0	-15.3	-13	Passed

Top Band Edge

Measured Frequency (MHz)	Peak Level	Limit	Result
1910.0	-15.3	-13	Passed

Graphical Data

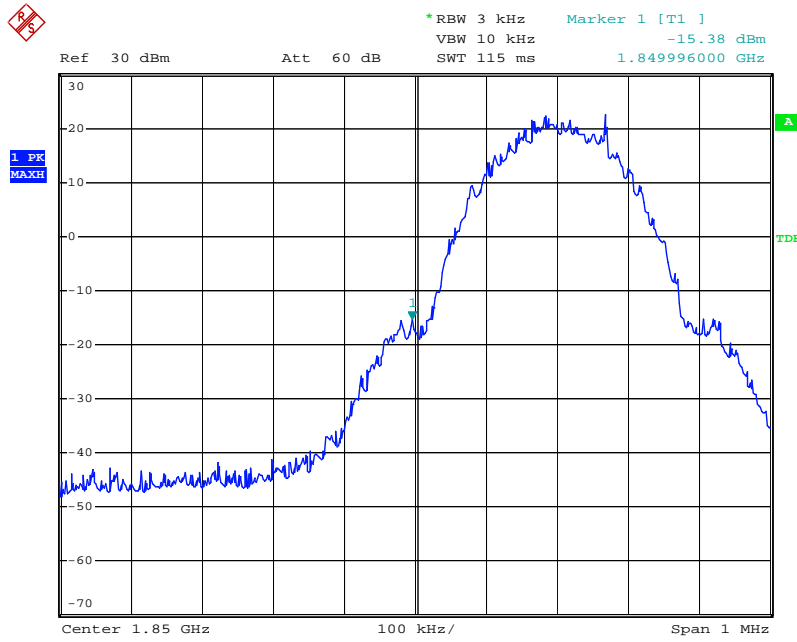

Bottom band edge

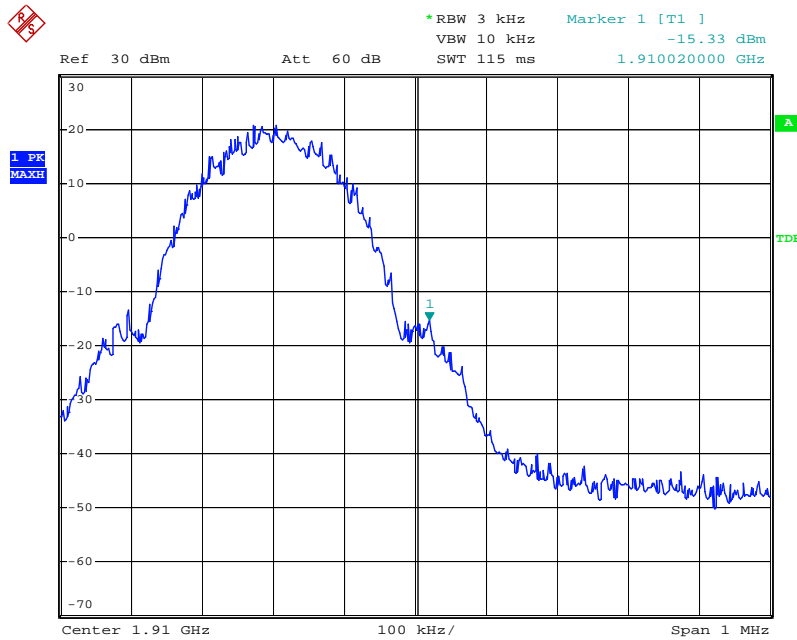

Top band edge

Test Equipment Used

Equipment name	RFT ID No.
Spectrum Analyzer	TR06
RF tester	RC03

Final Result

The EUT met the requirements of the standard for this test.

2.1.9 Transmitter AC Power Line Emission requirement

Reference Standard

FCC : Part15.207

IC : RSS-Gen Issue2 Sec7.2.2

Test Conditions

Date: 2008/10/08

Ambient Temperature: 20 degC

Relative humidity: 64 %

Test Voltage: 3.7 V

Test Method

- a) EUT is connected to RF tester with Max transmitter power level.
- b) AC power is supplied to AC charger through LISN.
- c) AC charger is connected to EUT.
- d) AC Line conducted emission is measured by EMI receiver.
 - Both Live/Neutral is measured emission level.

Test Setup

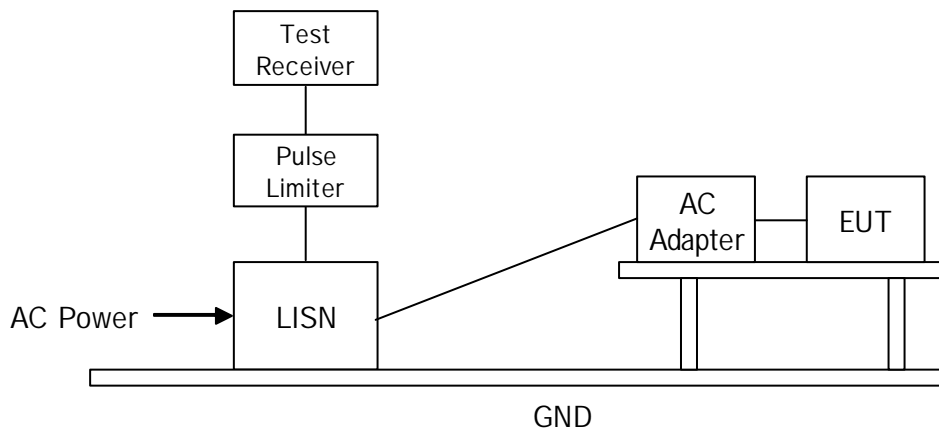

Limit

Frequency (MHz)	Limit QP (dBuV)	Limit AV (dBuV)
0.15 - 0.5	66 - 56	56 - 46
0.5 - 5	56	46
5 - 30	60	50

Test Results

Frequency (MHz)	Line (Live/Neutral)	QP Level (dBuV)	AVE Level (dBuV)	QP Limit (dBuV)	AVE Limit (dBuV)	Result
0.150	Live	42.7	15.0	66.0	56.0	Passed
1.386	Live	34.2	26.3	56.0	46.0	Passed
1.932	Live	32.5	23.5	56.0	46.0	Passed
3.432	Live	27.0	18.0	56.0	46.0	Passed
0.176	Neutral	46.4	30.4	64.7	54.7	Passed
1.826	Neutral	32.6	24.2	56.0	46.0	Passed
3.479	Neutral	24.4	17.1	56.0	46.0	Passed

Graphical Data

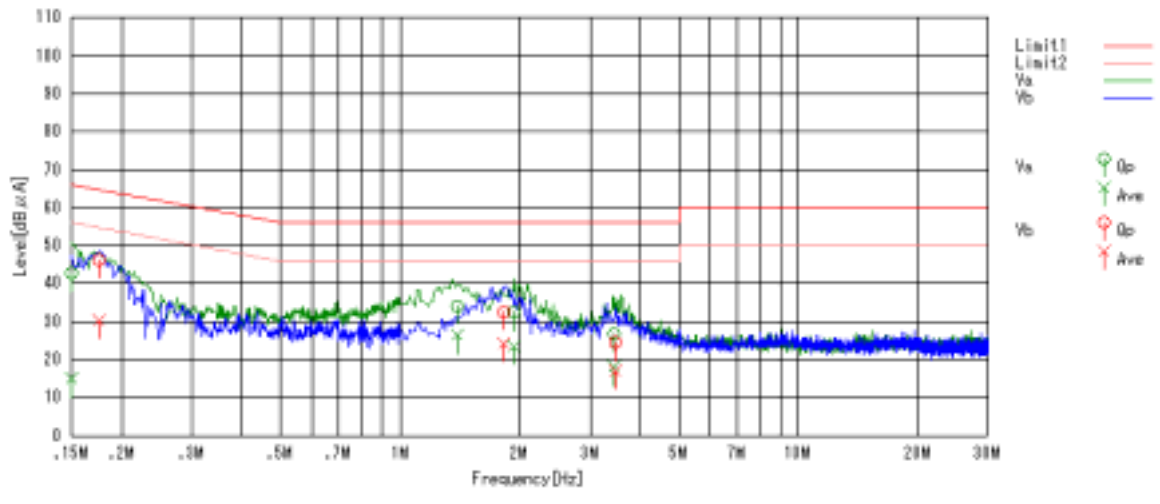

Test Equipment Used

Equipment name	RFT ID No.
EMI Receiver	TR06
LISN	LN05
RF tester	RC03

Final Result

The EUT met the requirements of the standard for this test

2.2 Receiver requirement

2.2.1 Receiver Spurious Emissions (Radiated)

Reference Standard

FCC : Part15.109

IC : RSS133 Issue4 Sec6.6

Test Conditions

Date: 2008/10/08

Ambient Temperature: 20 degC

Relative humidity: 64 %

Test Voltage: 3.7 V

Test Method

- EUT is connected to RF tester with idle mode.
- Radiated receiver spurious emission is received by receive antenna.
- Turn table is rotated 360deg.
- Maximum level of each spurious is measured by spectrum analyzer.
- RBW of spectrum analyzer is set to 100kHz for 30 - 1000MHz, 1MHz for above 1GHz.
- Level is measured with QP detect for 30 - 1000MHz, Average detect for above 1GHz.
- EUT was placed at three different orientations (X, Y and Z axis) in order to find the worst orientation.

Test Setup

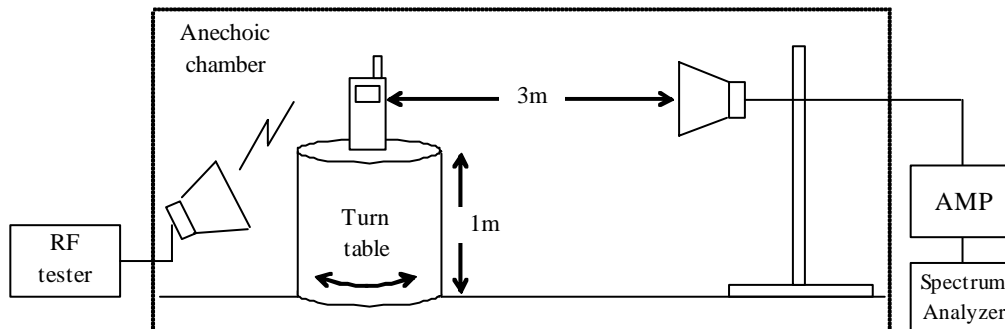

Limit

Frequency (MHz)	Distance (m)	Field strength (uV/m)	Field strength (dBuV/m)
30 - 88	3	100	40
88 - 216	3	150	43.5
216 - 960	3	200	46
above 960	3	500	54

Test Results

Frequency (MHz)	Antenna	Field strength (dBuV/m)	Limit (dBuV/m)	Result
30.570	Vert.	25.5	40.0	Passed
44.569	Vert.	21.8	40.0	Passed
51.623	Vert.	19.8	40.0	Passed
74.288	Vert.	16.7	40.0	Passed
85.440	Vert.	15.5	40.0	Passed
86.666	Vert.	17.4	40.0	Passed
130.000	Vert.	19.8	43.5	Passed
178.942	Hori.	22.8	43.5	Passed
216.666	Hori.	24.5	46.0	Passed

There is no other spurious.

The EUT could not achieved receiving mode only therefore the measurement was carried out under idle mode. The EUT is registered to the RF tester.

Graphical Data

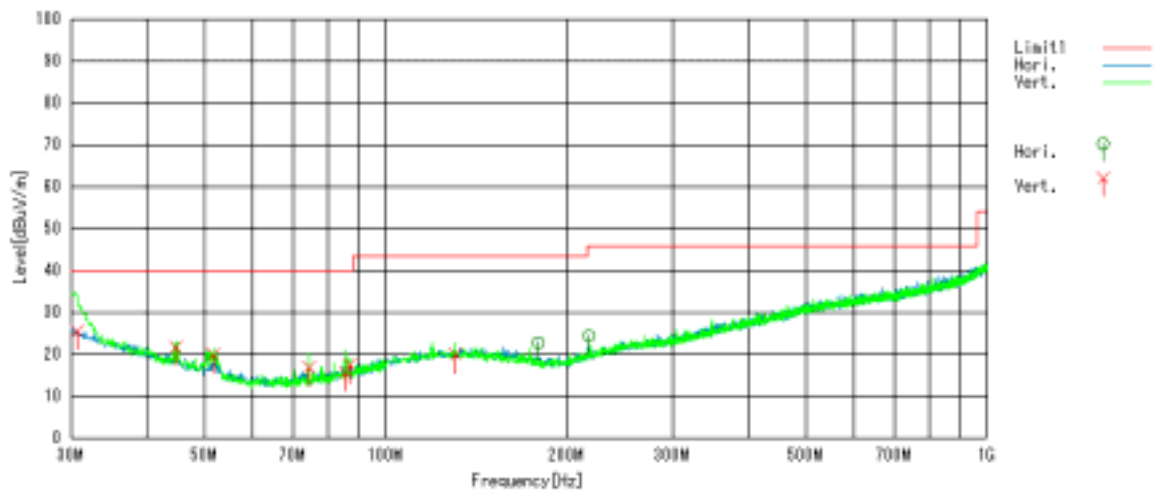

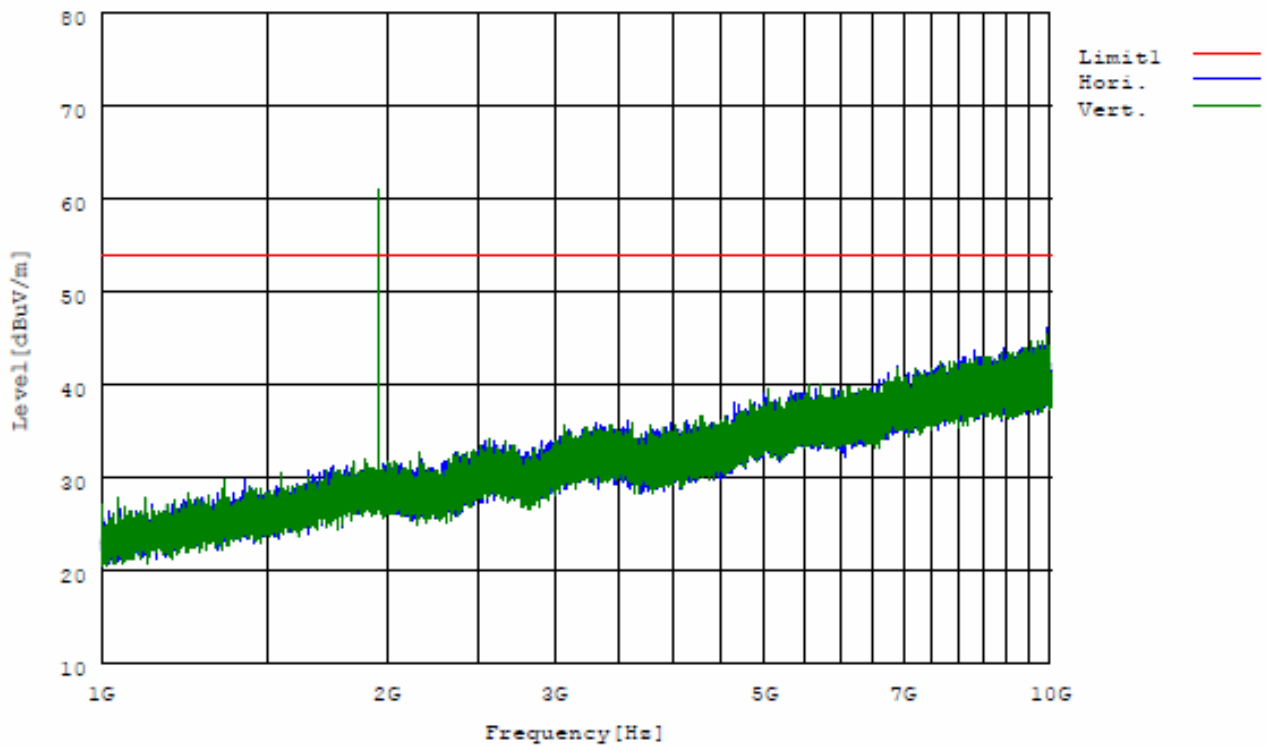

Note : A spectrum @1954MHz is downlink signal from RF tester. This is used to set EUT in idle mode. This is not a spurious emission from EUT.

Test Equipment Used

Equipment name	RFT ID No.
Spectrum Analyzer	TR06
Receive Antenna	DH02, BA03
Pre-AMP	PR04, PR03
RF tester	RC03

Final Result

The EUT met the requirements of the standard for this test.

2.2.2 Receiver AC Power Line Emission requirement

Reference Standard

FCC : Part15.107

IC : RSS-Gen Issue2 Sec7.2.2

Test Conditions

Date: 2008/10/08

Ambient Temperature: 20 degC

Relative humidity: 64 %

Test Voltage: 3.7 V

Test Method

- a) EUT is connected to RF tester with idle mode.
- b) AC power is supplied to AC charger through LISN.
- c) AC charger is connected to EUT.
- d) AC Line conducted emission is measured by EMI receiver.
 - Both Live/Neutral is measured emission level.

Test Setup

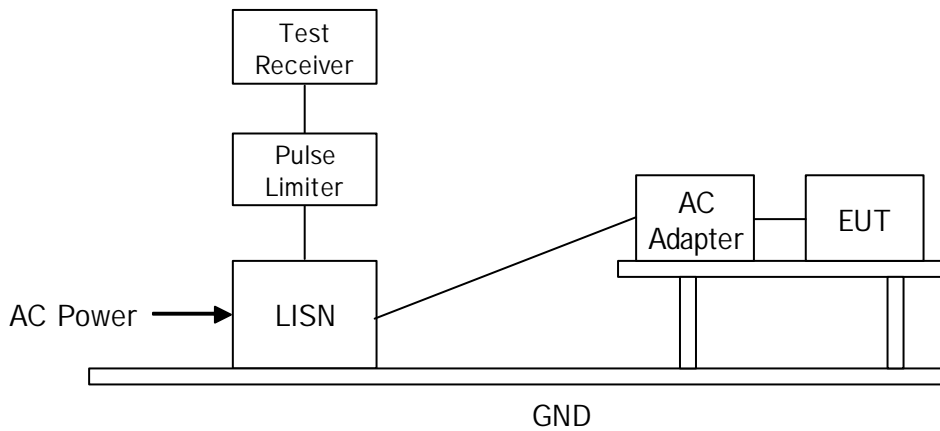

Limit

Frequency (MHz)	Limit QP (dBuV)	Limit AV (dBuV)
0.15 - 0.5	66 - 56	56 - 46
0.5 - 5	56	46
5 - 30	60	50

Test Results

The EUT could not achieved receiving mode only therefore the measurement was carried out under idle mode. The EUT is registered to the RF tester.

Frequency (MHz)	Line (Live/Neutral)	QP Level (dBuV)	AVE Level (dBuV)	QP Limit (dBuV)	AVE Limit (dBuV)	Result
0.173	Live	50.5	37.9	64.8	54.8	Passed
1.298	Live	37.5	28.5	56.0	46.0	Passed
1.910	Live	36.6	27.5	56.0	46.0	Passed
3.394	Live	29.0	21.0	56.0	46.0	Passed
0.173	Neutral	49.2	37.4	64.8	54.8	Passed
1.855	Neutral	34.5	23.9	56.0	46.0	Passed
3.539	Neutral	26.0	18.2	56.0	46.0	Passed

Graphical Data

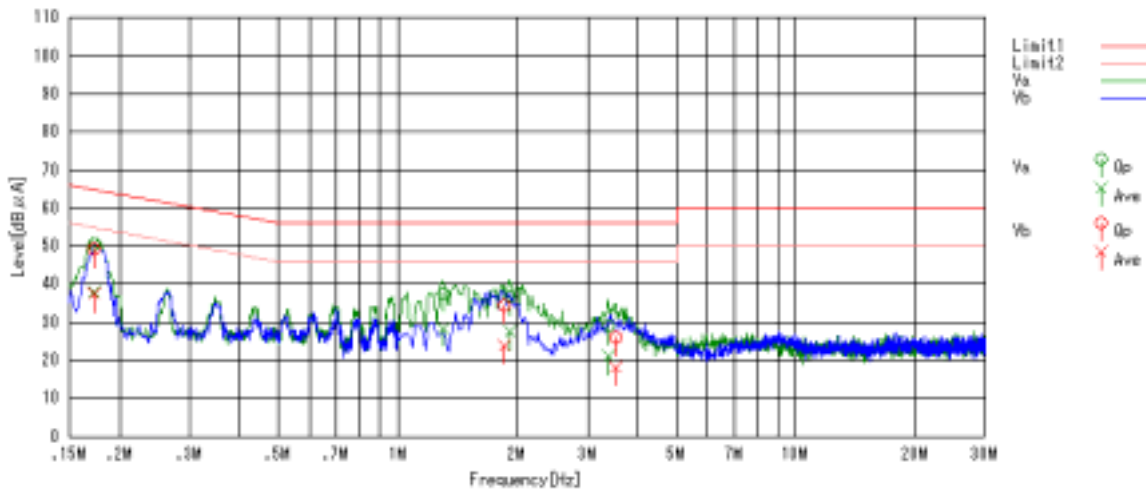

Test Equipment Used

Equipment name	RFT ID No.
EMI Receiver	TR06
LISN	LN05
RF tester	RC03

Final Result

The EUT met the requirements of the standard for this test

4 List of utilized test equipment/ calibration

RFT ID No.	Kind of Equipment and Precision	Manufacturer	Model No.	Serial Number	Calibration Date	Calibrated until
AC01	Anechoic Chamber (1st test room)	JSE	203397C	-	2008/7/4	2009/7/3
AC03	Anechoic Chamber (3rd test room)	JSE	-	-	2008/4/8	2009/4/7
BA03	Biological Antenna	CHASE	CBL6111	1309	2008/5/7	2009/5/6
BA04	Biological Antenna	SCHAFFNER	CA2855	2903	2008/1/4	2009/1/2
BI01	Biconical Antenna	SCHWARZBECK	VHA9103	2359	2008/7/1	2009/6/30
BI02	Biconical Antenna	SCHWARZBECK	VHA9103	2387	2008/7/1	2009/6/30
BRF1	Band Reject Filter (WCDMA2000)	M-City	BRF2000-06	VT0001	2008/4/1	2009/3/31
BRF2	Band Reject Filter (Bluetooth)	MICRO TRONICS	BRM50701	024	2008/4/1	2009/3/31
BRF3	Band Reject Filter (GSM900)	M-City	BRF0897-03	RF0005	2008/4/1	2009/3/31
BRF4	Band Reject Filter (WCDMA850)	M-City	BRF0835-01	RF0004	2008/4/1	2009/3/31
BRF5	Band Reject Filter (GSM1800)	M-City	BRF1750-01	RF0006-01	2008/9/8	2009/9/7
BRF6	Band Reject Filter (GSM1900)	M-City	BRF1880-02	RF0006-02	2008/9/8	2009/9/7
CL11	Antenna Cable	RFT	-	-	2008/6/11	2009/6/10
CL21	RF Cable 0.5m	SUCOFLEX	SF104PE	48772/4PE	2008/6/10	2009/6/9
CL22	RF Cable 2.0m	SUCOFLEX	SF104	274755/4	2008/6/10	2009/6/9
CL23	RF Cable 0.5m	SUCOFLEX	SF104PE	48773/4PE	2008/6/10	2009/6/9
CL24	RF Cable 5.0m	SUCOFLEX	SF104PE	48775/4PE	2008/6/10	2009/6/9
CL25	RF Cable 10m	SUCOFLEX	SF104E	20752/4E	2008/5/9	2009/5/8
DC01	Directional Coupler	KRYTAR	1850	77202	2008/5/9	2009/5/8
HC01	Harmonic Current Analysis system	NF	ES4153	9075640	2008/5/20	2009/5/19
HPF1	High Pass Filter (3500MHz)	TOKIMEC	TF323DCA	603	2008/6/9	2009/6/8
HPF2	High Pass Filter (900MHz)	M-City	HPF0900-01	RF0003-01	2008/6/9	2009/6/8
HPF3	High Pass Filter (2500MHz)	M-City	HPF2500-01	RF0006-03	2008/9/8	2009/9/7
LA01	Logperiodic Antenna	SCHWARZBECK	USLP 9143	338	2008/7/1	2009/6/30
LA02	Logperiodic Antenna	SCHWARZBECK	USLP 9143	339	2008/7/1	2009/6/30
LN02	LISN (3ph 32A)	SCHWARZBECK	NSLK8128	8128-212	2008/1/29	2009/1/27
LN05	LISN	Kyoritsu	KNW-407	8-1773-2	2008/5/21	2009/5/20
LN06	LISN	Kyoritsu	KNW-407	8-1773-3	2008/5/12	2009/5/11
LN11	LISN (for communication line)	FCC	FCC-TLISN-T4-02	20330	2008/1/10	2009/1/8

RFT ID No.	Kind of Equipment and Precision	Manufacturer	Model No.	Serial Number	Calibration Date	Calibrated until
LN13	LISN	Kyoritsu	KNW-407F	8-2003-3	2008/7/14	2009/7/13
LP01	Loop Antenna	EMCO	6502	3436	2008/6/10	2009/6/9
PL06	Pulse Limiter	PMM	PL-01	0000J10109	2008/1/17	2009/1/15
PL07	Transient Limiter	Agilent Technologies	11947A	3107A04000	2007/11/21	2008/11/19
PM03	Power Meter	Anritsu	ML2438A	99070001	2008/7/24	2009/7/23
PR03	Pre. Amplifier	Anritsu	MH648A	M41984	2008/5/12	2009/5/11
PR04	Pre. Amplifier (1-26G)	RFT	LNP126	060208-01	2008/6/10	2009/6/9
PR08	Pre. Amplifier	Sonoma Instrument	315	263504	2008/1/10	2009/1/9
PU03	Power Sensor	Anritsu	MA2472A	990103	2008/7/24	2009/7/23
SA06	Spectrum Analyzer (F/W: 3.60 SP1)	Rohde & Schwarz	FSP40	100071	2007/10/25	2008/10/23
SH01	Standard Horn Antenna (18-26G)	A.H. Systems	SAS-572	208	2008/7/23	2011/7/22
SH02	Standard Horn Antenna (18-26G)	A.H. Systems	SAS-572	209	2008/7/23	2011/7/22
TR04	Test Receiver (F/W : 3.82 SP1)	Rohde & Schwarz	ESCI	100447	2008/9/16	2009/9/15
TR06	Test Receiver (F/W : 3.93 SP2)	Rohde & Schwarz	ESU26	100002	2008/9/2	2009/9/1
DH01	DRG Horn Antenna	A.H. Systems	SAS-571	785	2008/1/31	2010/1/29
DH02	DRG Horn Antenna	A.H. Systems	SAS-200/571	239	2007/4/20	2009/4/18
DH04	DRB Horn Antenna	Schwarzbeck	BBHA9120B	2C-005	2008/2/13	2010/2/11
PM01	Power Meter	Rohde & Schwarz	NRVS	100055	2008/1/30	2009/1/28
PU01	Power Meter Insertion Unit	Rohde & Schwarz	URV5-Z4	100055	2008/1/30	2009/1/28
RC02	Radio communication tester (F/W : V5.00)	Rohde & Schwarz	CMU200	105097	2008/9/17	2009/9/16
RC03	Radio communication tester (F/W : 10.20 #005)	Anritsu	MT8820B	6200636657	2008/6/3	2009/6/2
SG04	Signal Generator	Rohde & Schwarz	SMG	51400285	2008/3/26	2009/3/25
SG05	Signal Generator	Rohde & Schwarz	SMR20	100905	2008/6/10	2009/6/9
SG07	Signal Generator	Agilent Technologies	N5181A	MY47070251	2008/5/12	2009/5/11
TC01	Temperature Chamber	ESPEC	SH-641	92000964	2008/5/7	2009/5/6

The measuring equipment, which was utilized in performing the tests documented herein, has been calibrated in accordance with the manufacturer's recommendations for utilizing calibration equipment, which is traceable to recognized national standards.