

Emissions Test Report

EUT Name: TransAir PTC-3000

Model No.: PTC-3000 RF

CFR 47 Part 80, 90 and RSS 119: 2011

Prepared for:

Lilee Systems, Ltd.
2905 Stender Way, Suite 78
Santa Clara, CA 95054 U.S.A.
Tel: (408) 988-8672

Prepared by:

TUV Rheinland of North America, Inc.
1279 Quarry Lane, Ste. A
Pleasanton, CA 94566
Tel: (925) 249-9123
Fax: (925) 249-9124
<http://www.tuv.com/>

Report/Issue Date: June 25, 2012
Report Number: 31260509.001

Statement of Compliance

Manufacturer: Lilee Systems, Ltd.
2905 Stender Way, Suite 78
Santa Clara, CA 95054 U.S.A.
Requester / Applicant: Lilee Systems, LTD
Name of Equipment: TransAir PTC-3000
Model No. PTC-3000 RF
Type of Equipment: Intentional Radiator
Application of Regulations: CFR 47 Part 80, 90 and RSS 119: 2011 Issue 11
Test Dates: 28 February 2012 to 18 May 2012

Guidance Documents:

Emissions: ANSI/TIA-603-C:2004

Test Methods:

Emissions: ANSI/TIA-603-C:2004

The electromagnetic compatibility test and documented data described in this report has been performed and recorded by TUV Rheinland, in accordance with the standards and procedures listed herein. As the responsible authorized agent of the EMC laboratory, I hereby declare that the equipment described above has been shown to be compliant with the EMC requirements of the stated regulations and standards based on these results. If any special accessories and/or modifications were required for compliance, they are listed in the Executive Summary of this report.

This report must not be used to claim product endorsement by NVLAP or any agency of the U.S. Government. This report contains data that are not covered by NVLAP accreditation. This report shall not be reproduced except in full, without the written authorization of TUV Rheinland of North America.



Suresh Kondapalli June 6, 2012
Test Engineer Date

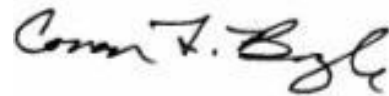

Conan Boyle June 25, 2012
NVLAP Signatory Date

NVLAP[®]
500011-0

FC
US5254

**INDUSTRY
CANADA**
2932M-1

1	Executive Summary	6
1.1	Scope	6
1.2	Purpose	6
1.3	Summary of Test Results	6
1.4	Special Accessories	9
1.5	Equipment Modifications	9
2	Laboratory Information	10
2.1	Accreditations & Endorsements	10
2.1.1	US Federal Communications Commission	10
2.1.2	NIST / NVLAP	10
2.1.3	Canada – Industry Canada	10
2.1.4	Japan – VCCI	10
2.1.5	Acceptance by Mutual Recognition Arrangement	11
2.2	Test Facilities	11
2.2.1	Emission Test Facility	11
2.2.2	Immunity Test Facility	11
2.3	Measurement Uncertainty	12
2.3.1	Sample Calculation – radiated & conducted emissions	12
2.3.2	Measurement Uncertainty	12
2.4	Calibration Traceability	13
3	Product Information	14
3.1	Product Description	14
3.2	Equipment Configuration	14
3.3	Operating Mode	14
3.4	Duty Cycle:	14
3.5	Unique Antenna Connector	15
3.5.1	Results	15
4	Emission Requirements – 216 to 222 MHz Band	16
4.1	Output Power Requirements	16
4.1.1	Test Method	16
4.1.2	Results	17
4.2	Occupied Bandwidth	44
4.2.1	Test Method	44
4.2.2	Results	45
4.3	Spectral Mask requirements	62
4.4	Conducted Spurious Emissions	79
4.4.1	Test Method	79
4.4.2	Results	80

4.5	Transmitter Spurious Emissions	113
4.5.1	Test Methodology	113
4.5.2	Transmitter Spurious Emission Limit	114
4.5.3	Test Results	114
4.5.4	Sample Calculation	128
4.6	Receiver Spurious Emissions	129
4.6.1	Test Methodology	129
4.6.2	Receiver Spurious Emission Limit	130
4.6.3	Test Results	130
4.6.4	Sample Calculation	133
4.7	Frequency Stability	134
4.7.1	Test Methodology	134
4.7.2	Test results	135
5	Test Equipment Use List	141
5.1	Equipment List	141
6	EMC Test Plan	142
6.1.1	Introduction	142
6.1.2	Customer	142
6.1.3	Equipment Under Test (EUT)	143
6.1.4	Test Specifications	147

Table 1:	Summary of Test Results	6
Table 2:	RF Output Power at the Antenna Port – Test Results	17
Table 3:	Occupied Bandwidth – Test Results	45
Table 4:	Spectral Mask Requirements – Test Results	63
Table 5:	Out of band Conducted Emission – Test Results	80
Table 6:	Frequency Stability – Test Results Fixed Mode	135
Table 7:	Frequency Stability – Test Results Fixed Mode	136
Table 8:	Frequency Stability – Test Results Mobile station mode	137
Table 9:	Frequency Stability – Test Results mobile Station mode	138
Table 10:	Customer Information	142
Table 11:	Technical Contact Information	142
Table 12:	EUT Specifications	143
Table 13:	EUT Channel Power Specifications	144
Table 14:	Interface Specifications:	146
Table 15:	Supported Equipment :	146

Index of Tables

Table 16: Description of Sample used for Testing..... 147
Table 17: Description of Test Configuration used for Radiated Measurement. 147
Table 18: Test Specifications 147

1 Executive Summary

1.1 Scope

This report is intended to document the status of conformance with the requirements of the CFR 47 Part 80, 90 and RSS 119: 2011 based on the results of testing performed from February 28 to May 18, 2012, on the TransAir PTC-3000 Model PTC-3000 RF manufactured by *Lilee Systems, LTD*. This report only applies to the specific samples tested under the stated test conditions. It is the responsibility of the manufacturer to assure that additional production units of this model are manufactured with identical or EMI equivalent electrical and mechanical components. This report is further intended to document changes and modifications to the EUT throughout its life cycle. All documentation will be included as a supplement.

1.2 Purpose

Testing was performed to evaluate the EMC performance of the EUT in accordance with the applicable requirements, procedures, and criteria defined in the application of regulations and application of standards listed in this report.

1.3 Summary of Test Results

Table 1: Summary of Test Results

Transmitter Modulation, output power and other parameters

Test	FCC Rule Part	RSS Rule Part	Measured value/ Comments	Limit/Requirement	Result
Frequency ranges (Listed for each channel spacing)	2.1033(C) (5) 80.45, 90.35	RSS-119	25 kHz, 216-222 MHz 12.5 kHz, 216-222 MHz 50 kHz, 216-222 MHz ¹	216-222 MHz ³	Complied
Power	2.1033(C) (6) 2.1033(C) (7) 2.1046 80.215 90.205	RSS-119 5.4.1 SRSP 512	28.2Watts (44.51 dBm) for mobile application ² Fixed station: Maximum conducted power is 35.15 Watts (45.46 dBm) ² . Actual power will be determined at the time installation. Power at antenna port will always less than 35.15Watts Lowest power 0.5watts	30 Watts (mobile) ³ 216 to 220 MHz RSS119 50Watts (mobile) FCC Part 80.215 50 Watts 220 to 222 MHz SRSP 512 110 Watts (Fixed) 216 to 220 MHz RSS 119 5.4.1 125 Watts 220-222 MHz SRSP 512 Table 6.1 and 90.205	Complied
Emission Mask	2.1033(C) (4) 2.1047 80.211(f) 90.210	RSS-119 5.5 table 5	Device Complies with spectral masks – see test data	Masks C & F (FCC) Masks F & J(IC)	Complied
Occupied (99%) Bandwidth	2.1049	RSS-119 5.5 table 3	8.94 kHz 216- 220 MHz 10.13 kHz 216-220 MHz 23.29 kHz 216-220 MHz 9 kHz 220-222 MHz 10.08 kHz 220-222 MHz 16.76 kHz 220-222 MHz	50/25/12.5/6.25 kHz FCC Part 90 11.25 kHz and 4 kHz for RSS119*	Complied

¹ Aggregate of 5 channels; * Authorized BW for single channel

² Power is variable actual power is chosen at the time installation depending on cable losses, ant height, gain and terrain as per FCC/ IC licensing procedures. Transmitter output power for fixed stations is factory set max limit at 45.5dBm (35.15watts). The EIRP calculation is based on max gain antenna of 14.1dBi and cable loss of 9.2dB. The equipment design prevents higher power by lockout/error message. Transmitter output power for mobile stations is factory set max limit at 44.5 dBm(28.2watts). The EIRP calculation is based on max gain antenna of 5.2dBi and cable loss of 2.8dB. The equipment design prevents higher power by lockout/error message. The minimum power of the device is 0.5 watts for both modes. ³ Lower of the FCC part 90 and RSS199 limits was considered; RSS-119 limits operation to 217-218 and 219-222 MHz.

Transmitter spurious emissions

Test	FCC Rule Part	RSS Rule Part	Measured value/ Comments	Limit/Requirement	Result
Transmitter spurious					
At Antenna Terminal	2.1051 2.1057	RSS-119 5.8	-26.61 dBm	-25 dBm	Complied
Radiated (erp)	80.211(f)				
Receiver spurious					
At Antenna terminal	15.111	RSS-GEN	-70.09 dBm	-57 dBm	Complied
Field strength	15.109	RSS-GEN	36.64 dBuV/m at 65 MHz	Refer Section	Complied

§ Calculated from measured field strength using free space propagation equation.

€ EUT is Class A device, at 10 meters

Other parameters

Test	FCC Rule Part	RSS Rule Part	Measured value/ Comments	Limit/Requirement	Result
Frequency Stability	2.1055 90.213(a)	RSS-119 5.3 Table 1	0.7 ppm (Mobile configuration) 0.099 ppm (Base Station Configuration)	216-220 MHz 1.5 ppm 220-222 MHz 0.1 ppm	Complied
RF Exposure	1.1307 (b) 2.1093 80.227	RSS-102	RF Exposure is addressed at time of licensing. MPE calculation is provided here.		
DC voltage and current for final amplifier stage	15.107	RSS-GEN	12 VDC, 6 Amps	Information only	-

1.4 Special Accessories

No special accessories were necessary in order to achieve compliance.

1.5 Equipment Modifications

None

2 Laboratory Information

2.1 Accreditations & Endorsements

2.1.1 US Federal Communications Commission



TUV Rheinland of North America at 1279 Quarry Ln, Pleasanton, CA 94566 is recognized by the commission for performing testing services for the general public on a fee basis. These laboratory test facilities have been fully described in reports submitted to and accepted by the FCC (US5254). The laboratory scope of accreditation includes: Title 47 CFR Parts 15, 18, and 90. The accreditation is updated every 3 years.

2.1.2 NIST / NVLAP



TUV Rheinland of North America is accredited by the National Voluntary Laboratory Accreditation Program, which is administered under the auspices of the National Institute of Standards and Technology. The laboratory has been assessed and accredited in accordance with ISO Guide 17025:2005 and ISO 9002 (Lab Code 500011-0). The scope of laboratory accreditation includes emission and immunity testing. The accreditation is updated annually.

2.1.3 Canada – Industry Canada



TUV Rheinland of North America at the 1279 Quarry Ln, Pleasanton, CA 94566 address is accredited by Industry Canada for performing testing services for the general public on a fee basis. This laboratory test facilities have been fully described in reports submitted to and accepted by Industry Canada (File Number 2932M-1). This reference number is the indication to the Industry Canada Certification Officers that the site meets the requirements of RSS 212, Issue 1 (Provisional). The accreditation is updated every 3 years.

2.1.4 Japan – VCCI



The Voluntary Control Council for Interference by Information Technology Equipment (VCCI) is a group that consists of Information Technology Equipment (ITE) manufacturers and EMC test laboratories. The purpose of the Council is to take voluntary control measures against electromagnetic interference from Information Technology Equipment, and thereby contribute to the development of a socially beneficial and responsible state of affairs in the realm of Information Technology Equipment in Japan. TUV Rheinland of North America at 1279 Quarry Ln, Pleasanton, CA 94566 has been assessed and approved in accordance with the Regulations for Voluntary Control Measures. (Registration Nos. A-0031& A-0032).

2.1.5 Acceptance by Mutual Recognition Arrangement



The United States has an established agreement with specific countries under the Asia Pacific Laboratory Accreditation Corporation (APLAC) Mutual Recognition Arrangement. Under this agreement, all TUV Rheinland at 1279 Quarry Ln, Pleasanton, CA 94566 test results and test reports within the scope of the laboratory NIST / NVLAP accreditation will be accepted by each member country.

2.2 Test Facilities

All of the test facilities are located at 1279 Quarry Lane, Pleasanton, California 94566, USA. The 2305 Mission College, Santa Clara, 95054, USA location is considered a Pleasanton Annex.

2.2.1 Emission Test Facility

The Semi-Anechoic chamber and AC Line Conducted measurement facility used to collect the radiated and conducted data has been constructed in accordance with ANSI C63.7:1992. The site has been measured in accordance with and verified to comply with the theoretical normalized site attenuation requirements of ANSI C63.4-2009, at a test distance of 3 and 5 meters. The site is listed with the FCC and accredited by NVLAP (Lab Code 500011-0). The 3/5-meter semi-anechoic chamber used to collect the radiated data has been verified to comply with the theoretical normalized site attenuation requirements of ANSI C63.4-2009, at a test distance of 3 meter and 5 meters. A report detailing this site can be obtained from TUV Rheinland of North America.

2.2.2 Immunity Test Facility

ESD, EFT, Surge, PQF: These tests are performed in an environmentally controlled room with a 3.7 m x 4.8 m x 3.175 mm thick aluminum floor connected to PE ground.

For ESD testing, tabletop equipment is placed on an insulated mat with a surface resistivity of 10^9 Ohms/square on a 1.6 m x 0.8 m x 0.8 m high non-conductive table with a 3.175 mm aluminum top (Horizontal Coupling Plane). The HCP is connected to the main ground plane via a low impedance ground strap through two 470-k Ω resistors. The Vertical Coupling Plane consists of an aluminum plate 50 cm x 50 cm x 3.175 mm thick. The VCP is connected to the main ground plane via a low impedance ground strap through two 470-k Ω resistors.

For EFT, Surge, PQF, the HCP and VCP are removed.

RF Field Immunity testing is performed in a 7.3m x 4.3m x 4.1m anechoic chamber.

RF Conducted and Magnetic Field Immunity testing is performed on a 4.8m x 3.7m x 3.175mm thick aluminum ground plane.

All test areas allow a minimum distance of 1 meter from the EUT to walls or conducting objects.

2.3 Measurement Uncertainty

Two types of measurement uncertainty are expressed in this report, per *ISO Guide To The Expression Of Uncertainty In Measurement*, 1st Edition, 1995.

The Combined Standard Uncertainty is the standard uncertainty of the result of a measurement when that result is obtained from the values of a number of other quantities; it is equal to the positive square root of the sum of the variances or co-variances of these other quantities, weighted according to how the measurement result varies with changes in these quantities. The term *standard uncertainty* is the result of a measurement expressed as a standard deviation.

2.3.1 Sample Calculation – radiated & conducted emissions

The field strength is calculated by subtracting the Amplifier Gain and adding the Cable Loss and Antenna Correction Factor to the measured reading. The basic equation is as follows:

$$\text{Field Strength (dB}\mu\text{V/m)} = \text{RAW} - \text{AMP} + \text{CBL} + \text{ACF}$$

Where: RAW = Measured level before correction (dBμV)

AMP = Amplifier Gain (dB)

CBL = Cable Loss (dB)

ACF = Antenna Correction Factor (dB/m)

$$\mu\text{V/m} = 10^{\frac{\text{dB}\mu\text{V/m}}{20}}$$

Sample radiated emissions calculation @ 30 MHz

Measurement +Antenna Factor–Amplifier Gain+Cable loss=Radiated Emissions (dBuV/m)

$$25 \text{ dBuV/m} + 17.5 \text{ dB} - 20 \text{ dB} + 1.0 \text{ dB} = 23.5 \text{ dBuV/m}$$

2.3.2 Measurement Uncertainty

	U_{lab}	U_{cispr}
Radiated Disturbance		
30 MHz – 40,000 MHz	3.2 dB	5.2 dB
Conducted Disturbance @ Mains Terminals		
150 kHz – 30 MHz	2.4 dB	3.6 dB
Disturbance Power		
30 MHz – 300 MHz	3.92 dB	4.5 dB

Measurement Uncertainty – Immunity Testing

The estimated combined standard uncertainty for ESD immunity measurements is $\pm 4.1\%$.
The estimated combined standard uncertainty for radiated immunity measurements is ± 2.7 dB.
The estimated combined standard uncertainty for conducted immunity measurements is ± 1.4 dB.
The estimated combined standard uncertainty for damped oscillatory wave immunity measurements is $\pm 8.8\%$.
The estimated combined standard uncertainty for harmonic current and flicker measurements is $\pm 0.45\%$.

Measurement Uncertainty – Radio Testing

The estimated combined standard uncertainty for frequency error measurements is ± 3.88 Hz
The estimated combined standard uncertainty for carrier power measurements is ± 1.59 dB.
The estimated combined standard uncertainty for adjacent channel power measurements is ± 1.47 dB.
The estimated combined standard uncertainty for modulation frequency response measurements is ± 0.46 dB.
The estimated combined standard uncertainty for transmitter conducted emission measurements is ± 4.01 dB

The expanded uncertainty at a level of 95% confidence is obtained by multiplying the combined standard uncertainty by a coverage factor of 2. Compliance criteria are not based on measurement uncertainty.

2.4 Calibration Traceability

All measurement instrumentation is traceable to the National Institute of Standards and Technology (NIST). Measurement method complies with ANSI/NCSL Z540-1-1994 and ISO Standard 17025:2005. Equipment calibration records are kept on file at the test facility.

3 Product Information

3.1 Product Description

PTC-3000 RF is Transceiver module intended for use in Lilee systems TransAir PTC-3000 product family products.

The Lilee Systems TransAir PTC-3000 product family includes three components: TransAir Wayside, TransAir Base Station and TransAir Locomotive radios. The TransAir PTC product family's design is based on both ACSES and an interoperable train control (ITC) architecture that in conjunction with the Lilee Mobility Controller (LMC-5x00 series) enables seamless roaming and constant communication between central traffic control, wayside signals, and onboard locomotive networks. This combined solution can help freight railroads and transit operators maintain compliance with the Federal Rail Safety Improvement Act of 2008.

3.2 Equipment Configuration

A description of the equipment configuration is given in the Test Plan Section. The EUT was tested as called for in the test standard and was configured and operated in a manner consistent with its intended use. The EUT was connected to rated power and allowed to reach intended operating conditions. The placement of the EUT system components was guided by the test standard and selected to represent typical installation conditions.

In the case of EUT that can operate in more than one configuration, preliminary testing was performed to determine the configuration that produced maximum radiation.

The final configuration was selected to produce the worst case radiation for emissions testing and to place the EUT in the most susceptible state for immunity testing.

3.3 Operating Mode

A description of the operation mode is given in the Test Plan Section. For EUT that can operate in more than one state, preliminary testing was performed to determine the operating mode that produced maximum radiation.

The final operating mode was selected to produce the worst case radiation for emissions testing and to place the EUT in the most susceptible state for immunity testing.

3.4 Duty Cycle:

EUT was operated at 100% duty cycle. No duty cycle correction was added to the results.

3.5 Unique Antenna Connector

An intentional radiator shall be designed to ensure that no antenna other than that furnished by the responsible party shall be used with the device. The use of a permanently attached antenna or of an antenna that uses a unique coupling to the intentional radiator shall be considered sufficient to comply with the provisions of this Section. The manufacturer may design the unit so that a broken antenna can be replaced by the user, but the use of a standard antenna jack or electrical connector is prohibited. This requirement does not apply to carrier current devices or to devices operated under the provisions of CFR47 Parts 15.211, 15.213, 15.217, 15.219, or 15.221.

3.5.1 Results

PTC radio module is professionally installed. This requirement is not applicable.

4 Emission Requirements – 216 to 222 MHz Band

Testing was performed in accordance with CFR 47 Part 80, 90 and RSS 119, FCC part 15. These test methods are listed under the laboratory's NVLAP Scope of Accreditation. This test measures the levels emanating from the EUT, thus evaluating the potential for the EUT to cause radio frequency interference to other electronic devices. Procedures described in section 8 of the standard were used.

4.1 Output Power Requirements

The maximum output power requirement is the maximum equivalent isotropic radiated power delivering at the transmitting antenna under specified conditions of measurements in the presence of modulation.

The maximum output power and harmonics shall not exceed CFR47 Part 80, 90 and RSS 119

4.1.1 Test Method

The conducted method was used to measure the power output according to ANSI/TIA-603-C: 2004 The measurement was performed with modulation per ANSI/TIA-603-C: 2004 was conducted on 3 channels in each operating range. The worst mode result indicated below.

Test Setup:

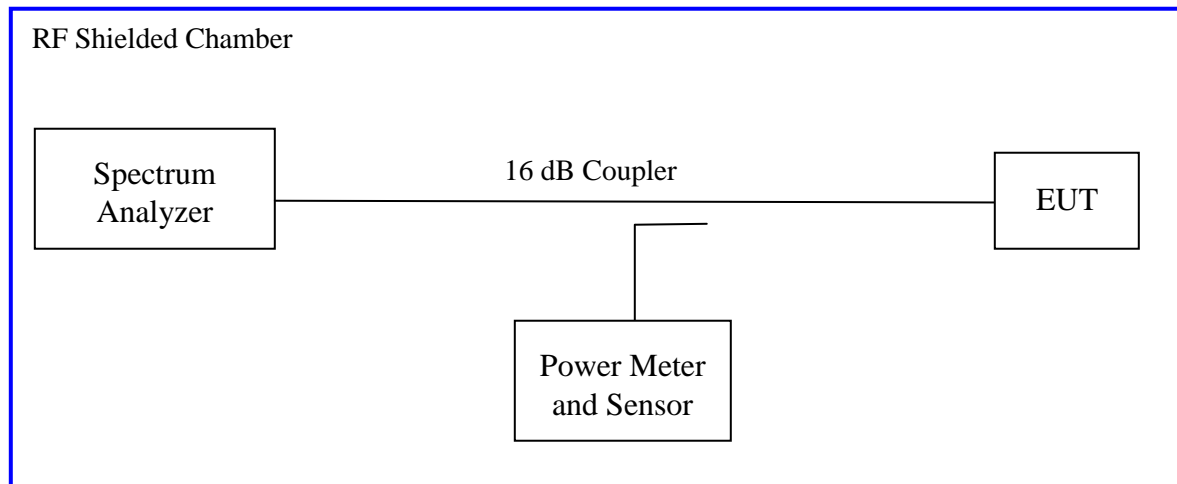

4.1.2 Results

As originally tested, the EUT was found to be compliant to the requirements of the test standard(s).

Table 2: RF Output Power at the Antenna Port – Test Results

Test Conditions: Conducted Measurement, Normal Temperature								
Antenna Type: Max Fixed station gain 14.1 dBi Dual Yagi Antenna								
Signal State: Modulated see below								
Ambient Temp.: 21 °C				Relative Humidity: 39%				
Freq.	Modulation	Power Setting	Measured power at Antenna Port		Limit Base Station Mode		Result	
MHz			dBm	Watts	CFR Part 80/90	IC RSS 119		
216.00	GMSK 9600	ATT 0	44.88	30.76	50 W at antenna input terminal 80.215 (216 - 220MHz)	110W Para 5.4.1	Pass	
	QPSK 16K	ATT 0	44.03	25.29				
	QPSK 32K	ATT 2	44.95	31.26				
217.500	GMSK 9600	ATT 0	45.45	35.05				
	QPSK 16K	ATT 0	45.44	34.99				
	QPSK 32K	ATT 2	45.46	35.15				
218.500	GMSK 9600	ATT 0	45.34	34.20		110W ERP 90.729 (220-222MHz)		125W ERP SRSP 512 (220-220MHz)
	QPSK 16K	ATT 0	45.44	34.99				
	QPSK 32K	ATT 2	45.46	35.15				
220.0125	GMSK 9600	ATT 0	44.51	28.24				
	QPSK 16K	ATT 2	44.41	28.24				
	QPSK 32K	ATT 15	39.93	9.84				
220.4875	GMSK 9600	ATT 0	44.58	28.70				
	QPSK 16K	ATT 2	43.46	22.18				
	QPSK 32K	ATT 15	40.18	10.42				
220.9875	GMSK 9600	ATT 0	44.45	35.05				
	QPSK 16K	ATT 2	43.95	24.83				
	QPSK 32K	ATT 15	39.90	9.77				

222.00	GMSK 9600	ATT 0	45.11	32.43		
	QPSK 16K	ATT 2	44.47	27.99		
	QPSK 32K	ATT 15	40.50	11.22		

Note1: The output power is adjusted at the time of installation, considering the cable losses and antenna gain

Note2: Power measurements were performed as indicated in the above table. Only worst case/ limited number of plots are placed in the report.

Note3: Frequency 220-221MHz is assigned to Fixed stations and 221 to 222Mhz is assigned to mobile stations

Note4: RSS-119 limits operation to 217-218 and 219-222 MHz.

Mobile Mode

Test Conditions: Conducted Measurement, Normal Temperature										
Antenna Type: Highest gain for Mobile 5 dBi										
Signal State: Modulated										
Ambient Temp.: 21 °C				Relative Humidity: 39%						
Frequency	Modulation	Power setting	Measured Power at Antenna Port		ERP Limit		Result			
			Mobile Mode							
MHz			dBm	Watts	CFR 47	RSS 119				
216.00	GMSK 9600	ATT 4	43.79	23.99	30W 216 to 220MHz Part 80.215	30W Para 5.4.1	Complies			
	QPSK 16K	ATT 0	44.03	25.29						
	QPSK 32K	ATT 7	44.45	27.86						
217.500	GMSK 9600	ATT 4	44.20	26.30						
	QPSK 16K	ATT 4	44.21	26.36						
	QPSK 32K	ATT 7	44.20	26.30						
218.500	GMSK 9600	ATT 4	44.20	26.30						
	QPSK 16K	ATT 4	44.40	27.54						
	QPSK 32K	ATT 7	44.40	27.54						
220.0125	GMSK 9600	ATT 0	44.51	28.24				50 W ERP Part 90.729 (220- 222MHz)	50W SRSP512 Para 6.3.1.4 (220- 222MHz)	Complies
	QPSK 16K	ATT 2	44.41	27.60						
	QPSK 32K	ATT 15	39.93	9.84						
220.4875	GMSK 9600	ATT 0	44.51	28.24						
	QPSK 16K	ATT 2	43.46	22.18						
	QPSK 32K	ATT 15	40.18	10.42						
220.9875	GMSK 9600	ATT 0	44.45	35.05						
	QPSK 16K	ATT 2	43.95	24.83						
	QPSK 32K	ATT 15	39.90	9.77						

222.00	GMSK 9600	ATT 4	44.40	27.54		
	QPSK 16K	ATT 2	44.47	27.99		
	QPSK 32K	ATT 15	40.50	11.22		

Note1: Maximum conducted power limited to 44.5dBm (28.2Watts) Output power is adjusted at the time installation based antenna gain and cable losses. The minimum power of the device is 0.5watts

Note2: Power measurements were performed as indicated in the above table. Only worst case/ limited number of plots are placed in the report.

Note3: Frequency 220-221MHz is assigned to fixed stations and 221 to 222MHz is assigned to mobile stations

Note4: RSS-119 limits operation to 217-218 and 219-222 MHz.

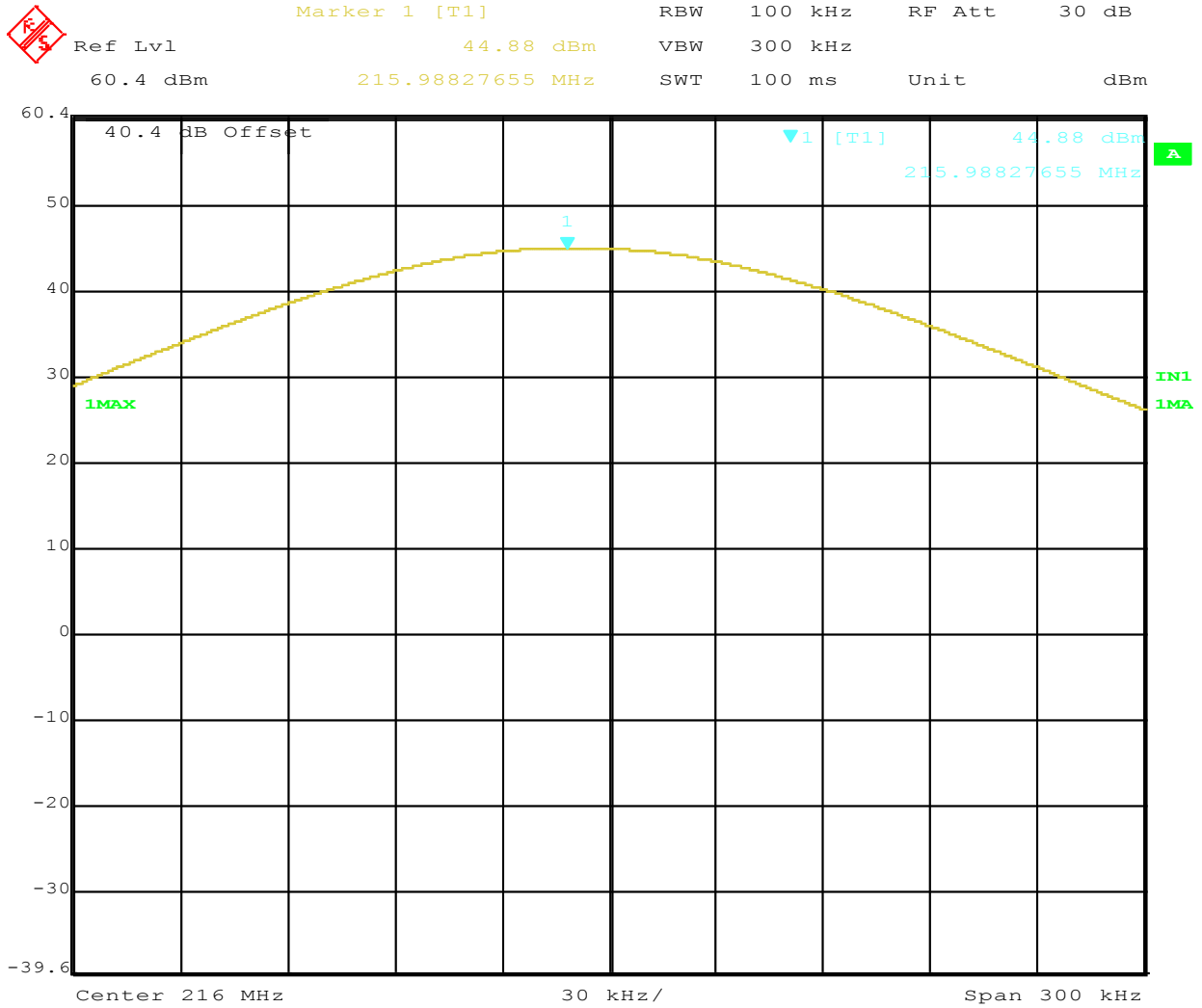

Date: 18.MAY.2012 16:28:12

Figure 1: Maximum Transmitted Power, 216.0 MHz GMSK 9600

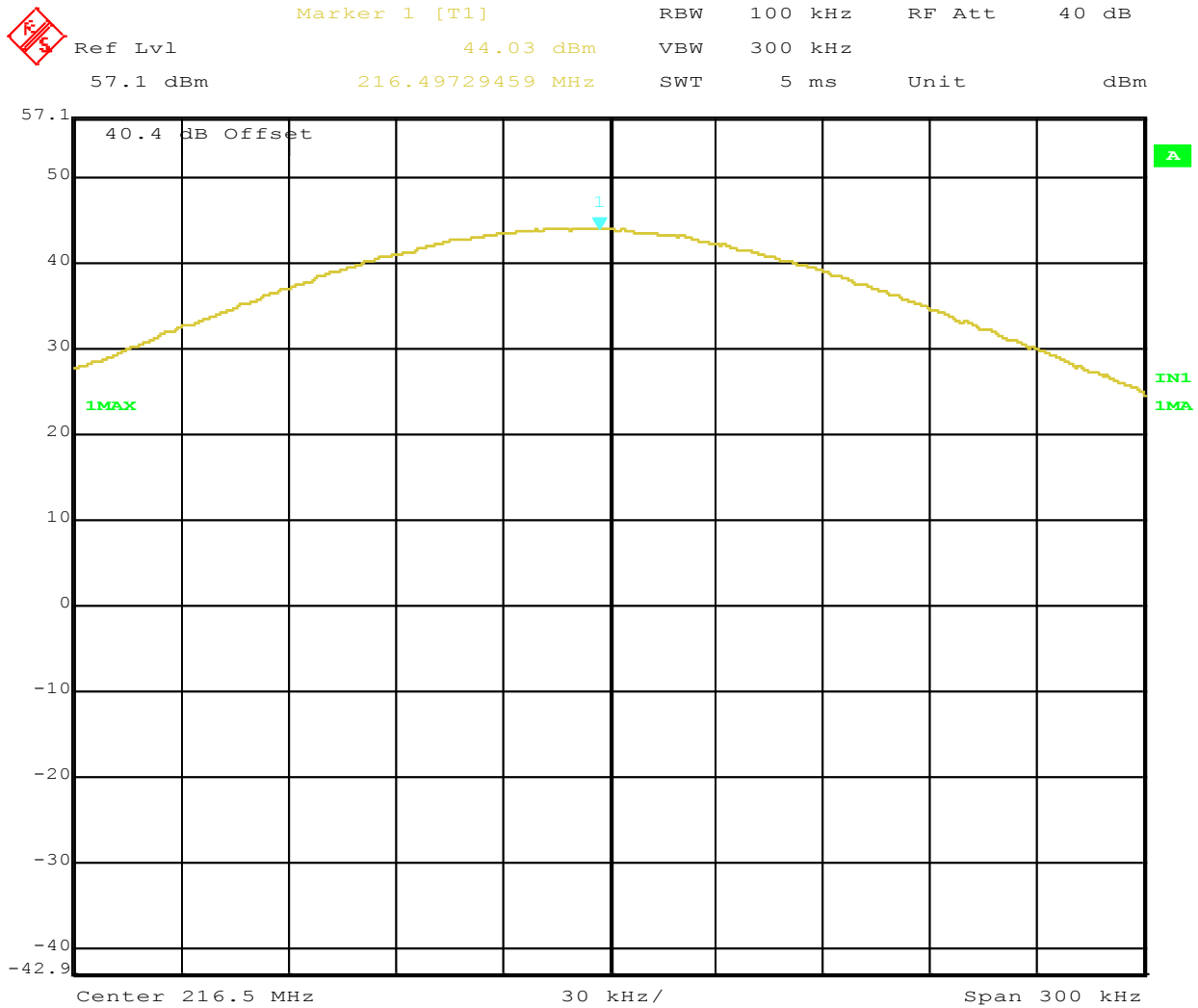

Date: 18.MAY.2012 15:35:25

Figure 2: Maximum Transmitted Power, 216 MHz 16QPSK

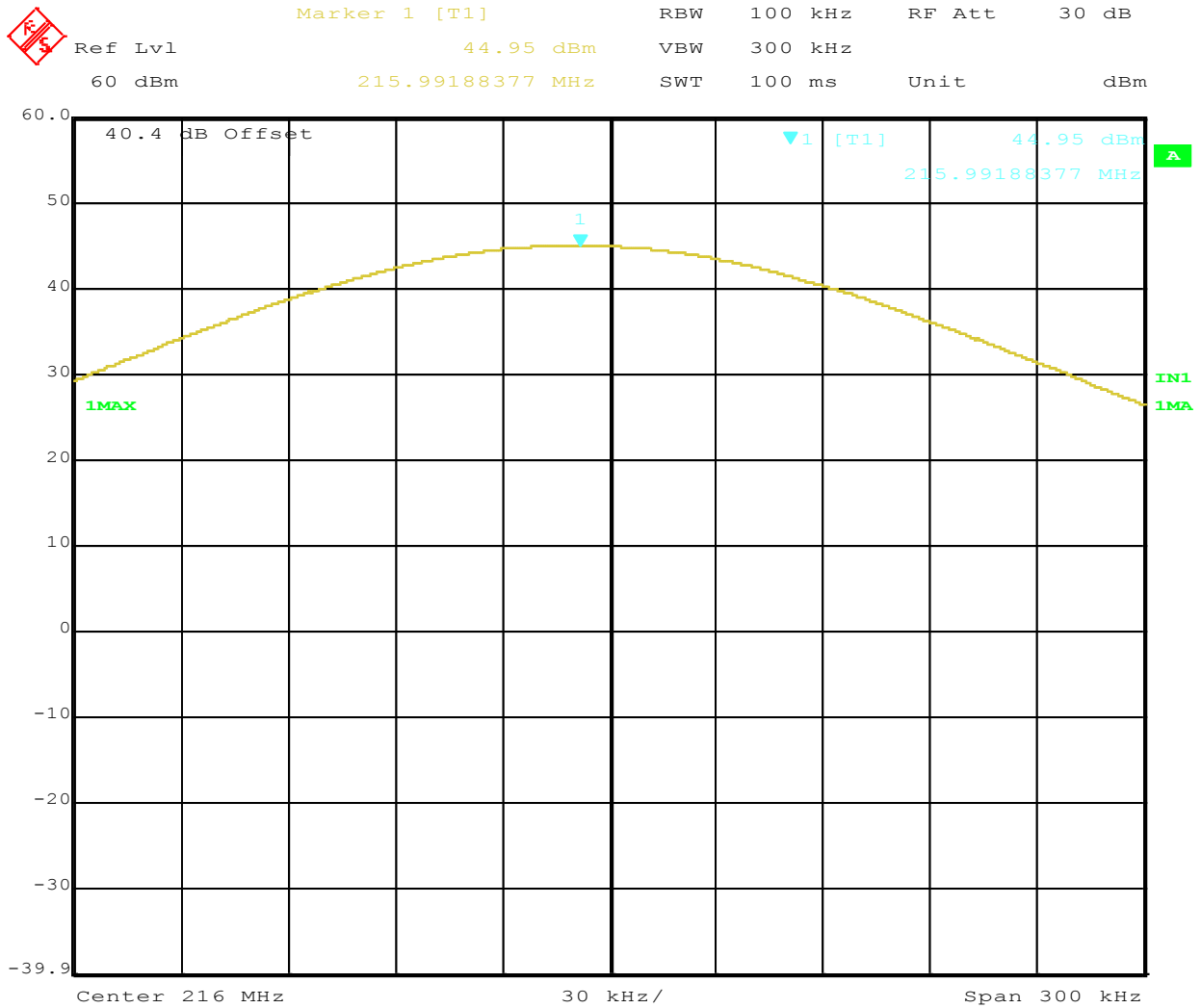

Date: 18.MAY.2012 16:17:39

Figure 3: Maximum Transmitted Power, 216 MHz 32QPSK

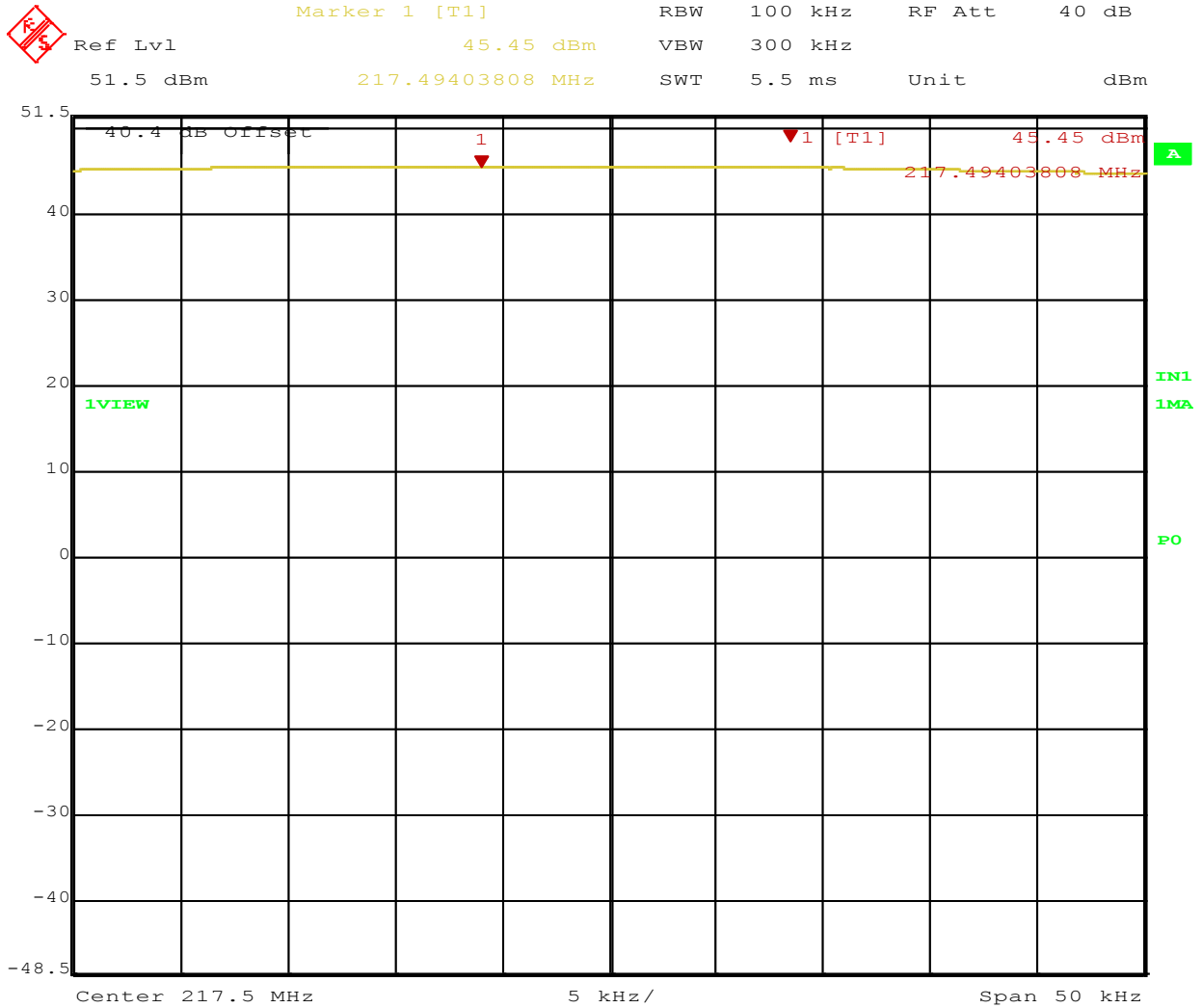

Title: Power217.5 GMSK9600 Powersetting full power
 Date: 29.FEB.2012 13:50:59

Figure 4: Maximum Transmitted Power, 217.5 MHz GMSK 9600,

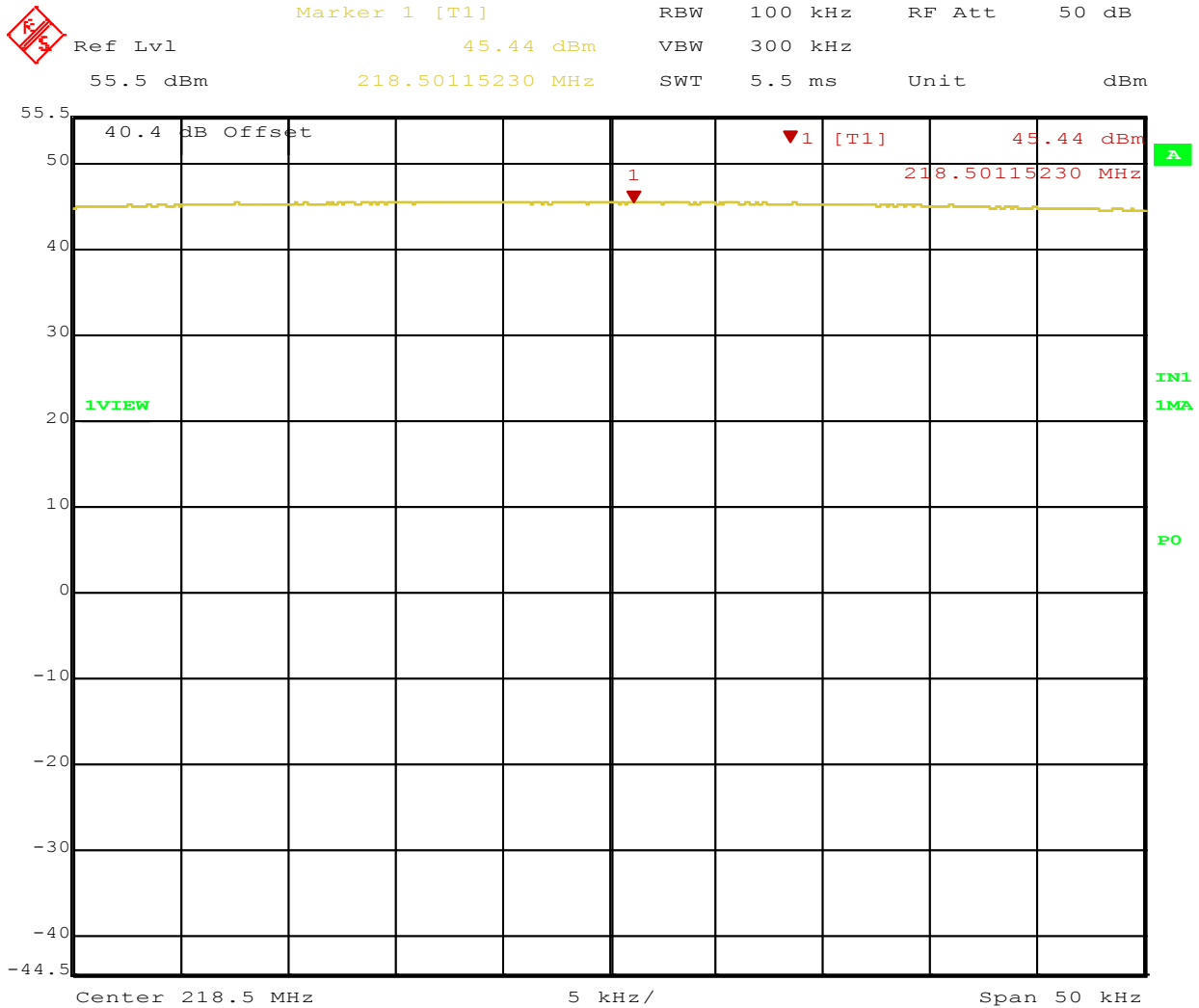

Title: Power 218.5 QPSK 16K Powersetting full power
 Date: 29.FEB.2012 16:22:42

Figure 5: Maximum Transmitted Power, 217.5 MHz, 16 QPSK

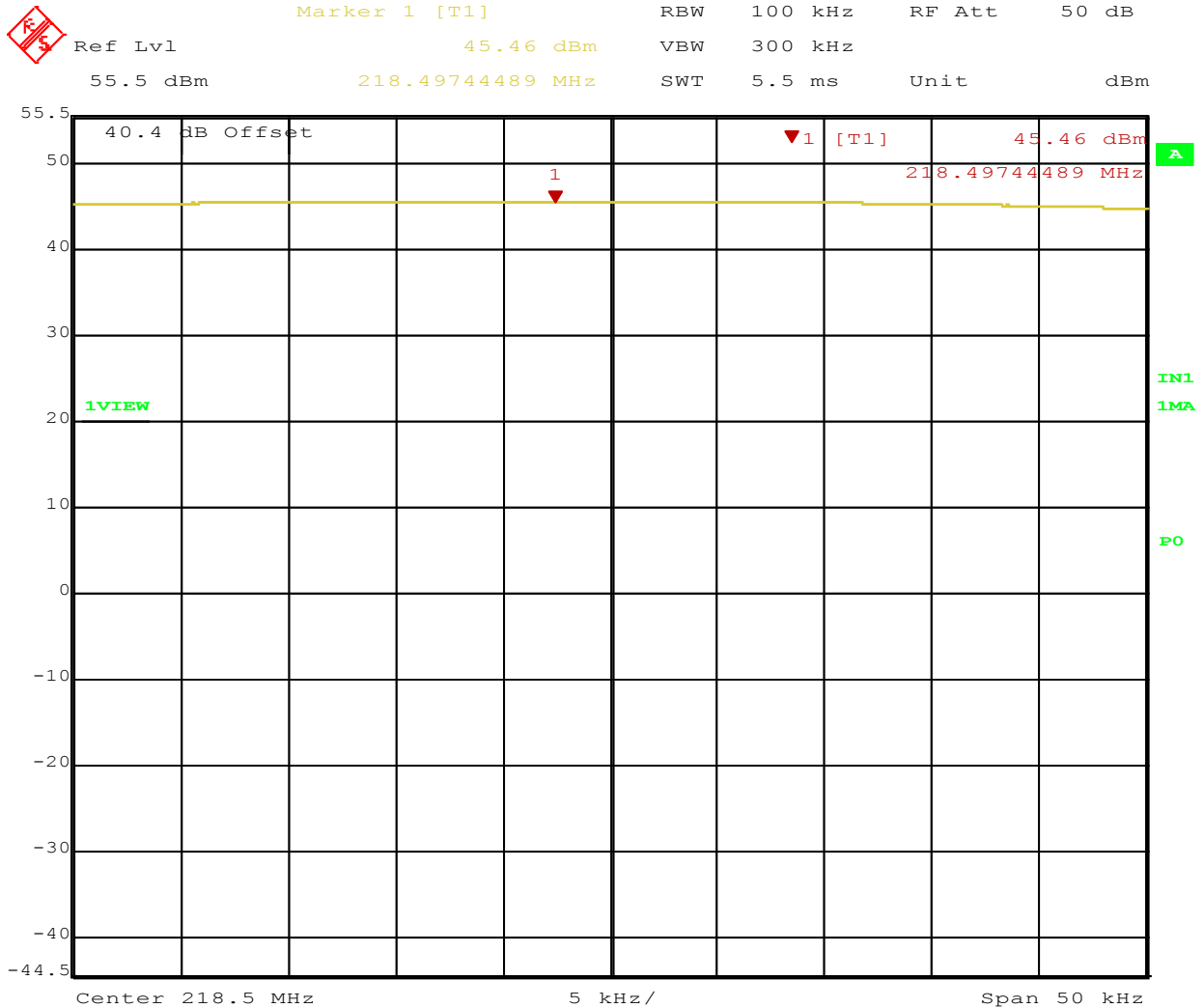

Title: Power FCC Mask 80.11 218.5 QPSK 32k Powersetting att 2
 Date: 29.FEB.2012 17:30:56

Figure 6: Maximum Transmitted Power, 217.5 MHz at 32 QPSK

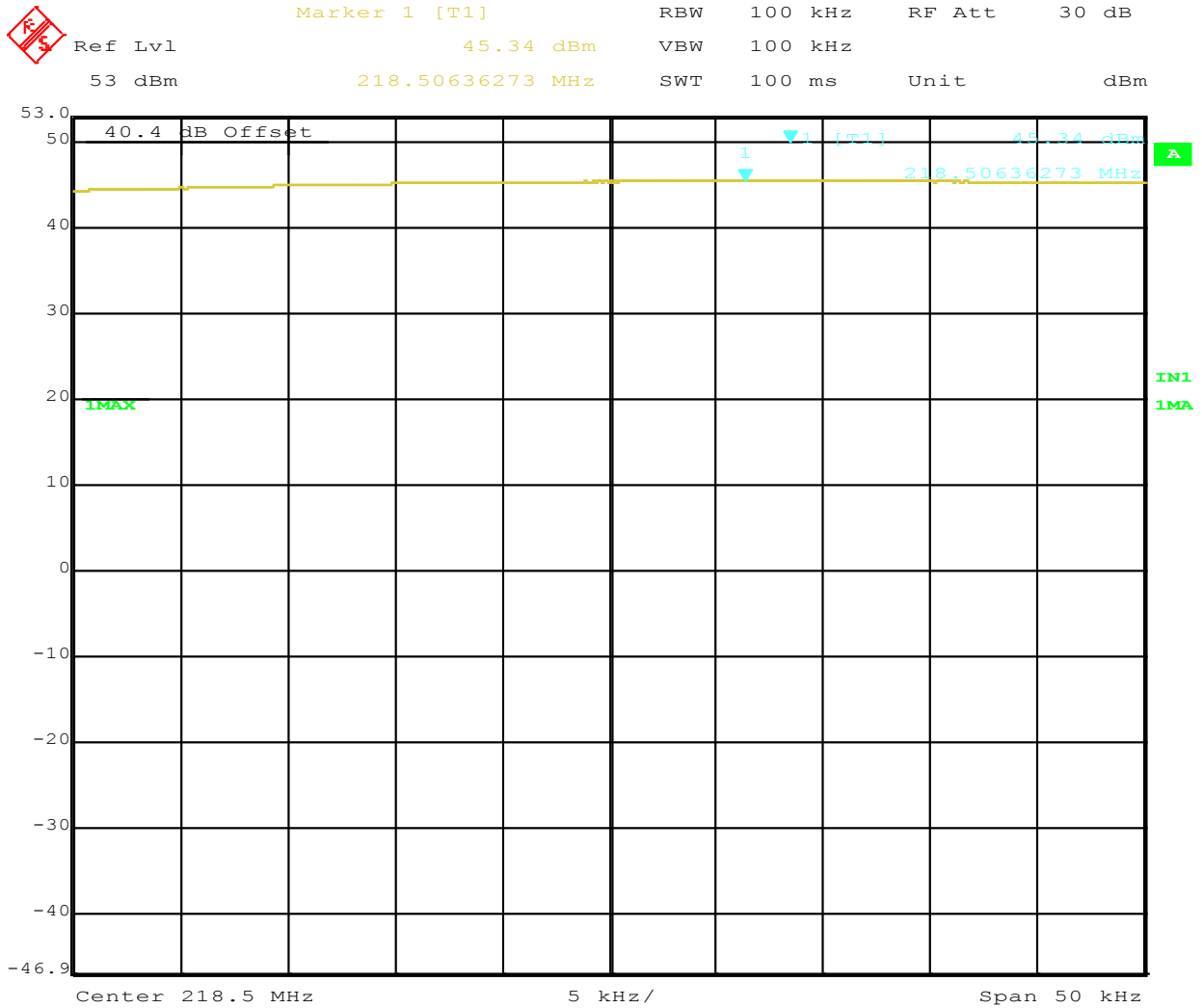
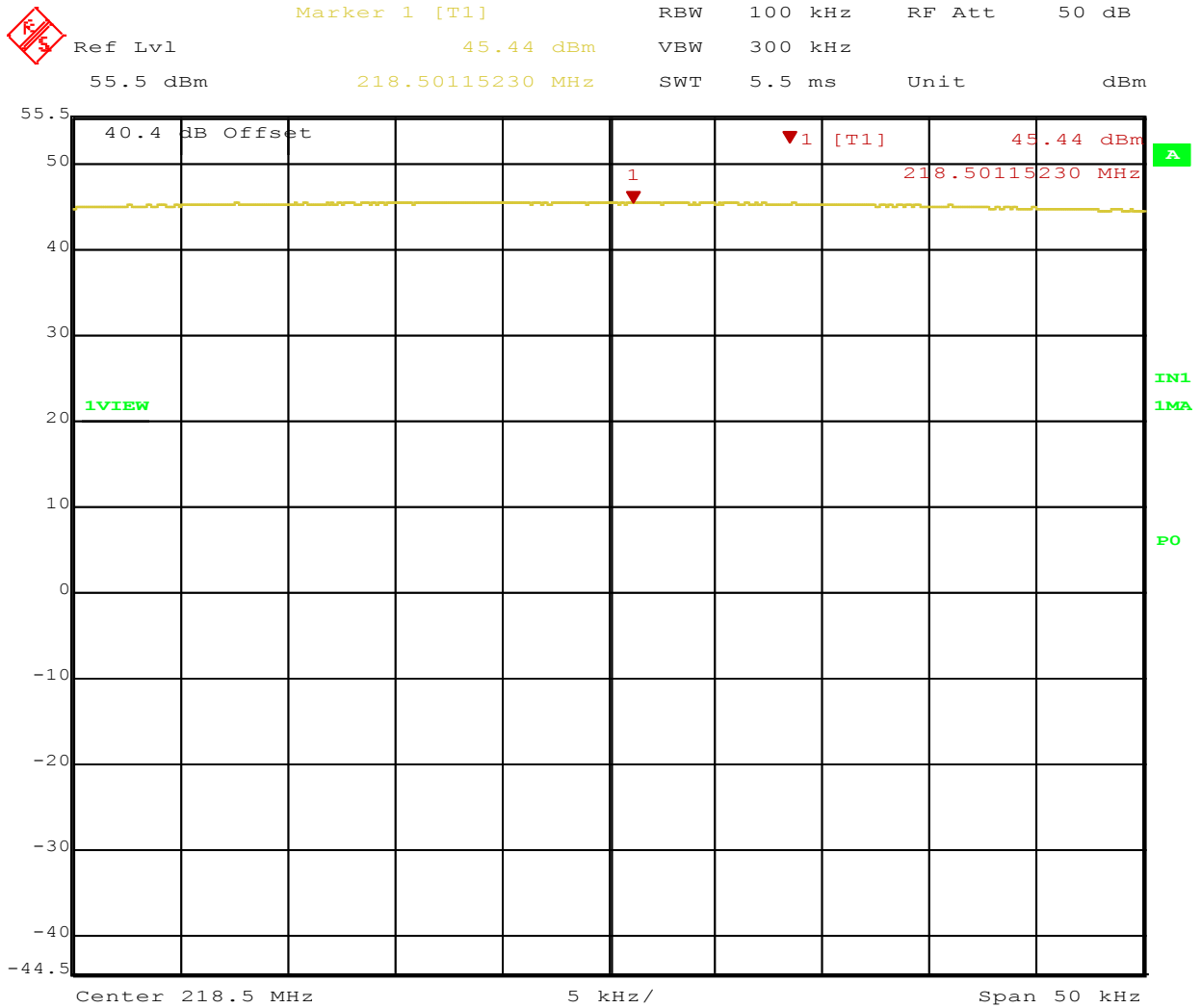
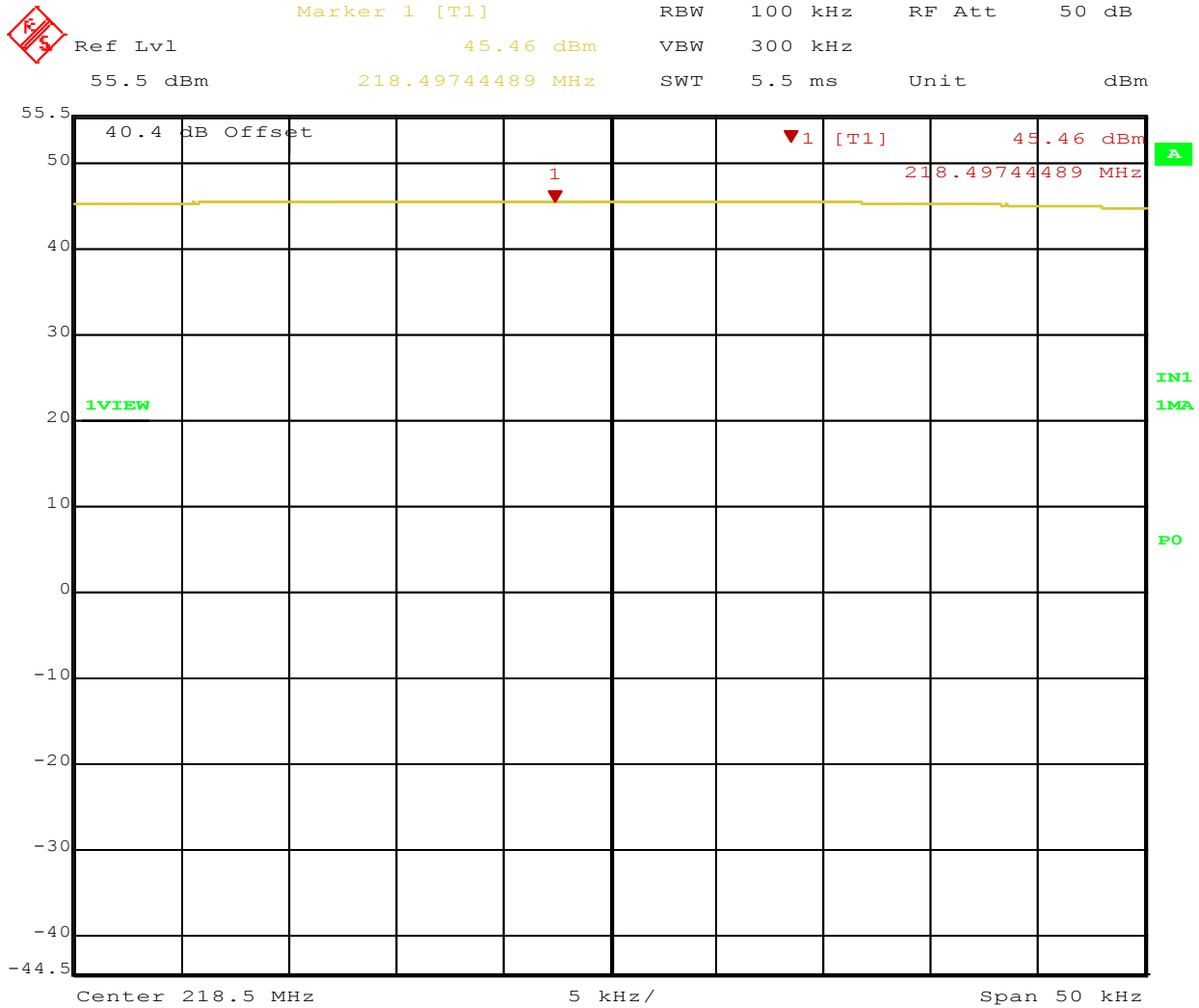

Figure 7: Maximum Transmitted Power, 218.5 MHz at GMSK



Title: Power 218.5 QPSK 16K Powersetting full power
 Date: 29.FEB.2012 16:22:42

Figure 8: Maximum Transmitted Power, 218.5 MHz at 16 QPSK



Title: Power FCC Mask 80.11 218.5 QPSK 32k Powersetting att 2
 Date: 29.FEB.2012 17:30:56

Figure 9: Maximum Transmitted Power, 218.5 MHz at 32 QPSK

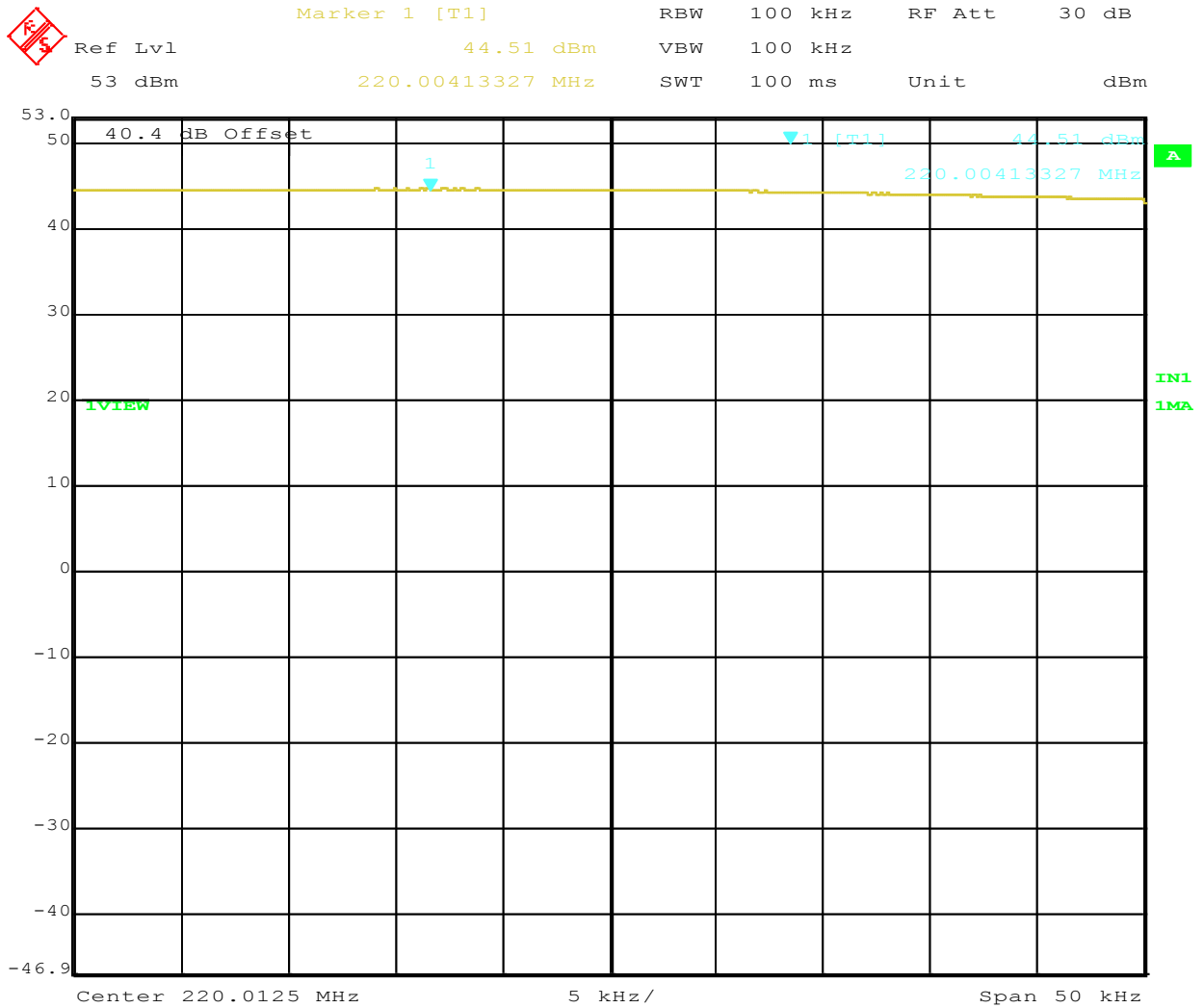

Date: 23.APR.2012 15:43:39

Figure 10: Maximum Transmitted Power, 220.0125MHz GMSK

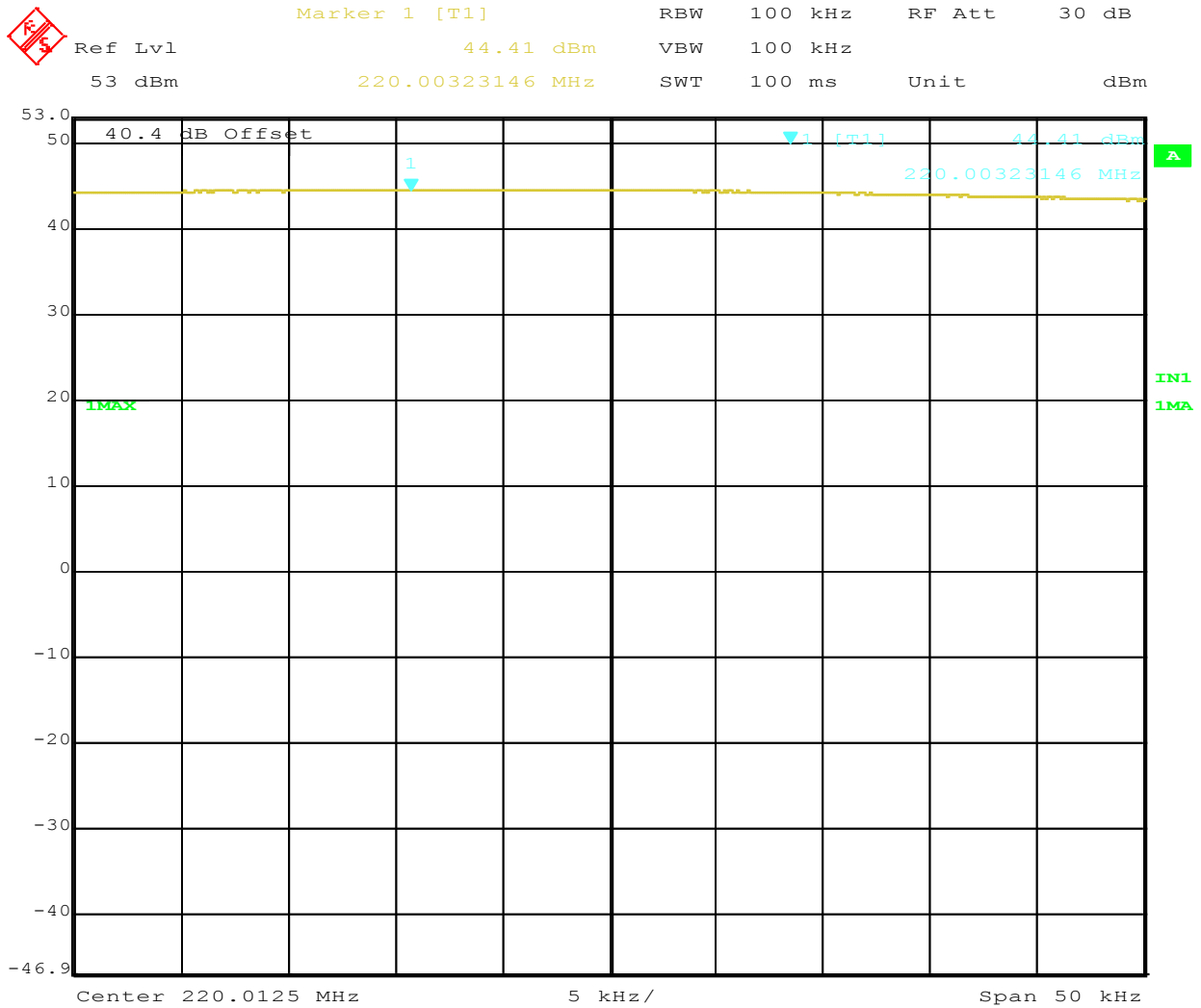

Date: 23.APR.2012 14:53:57

Figure 11: Maximum Transmitted Power, 220.0125MHz 16QPSK

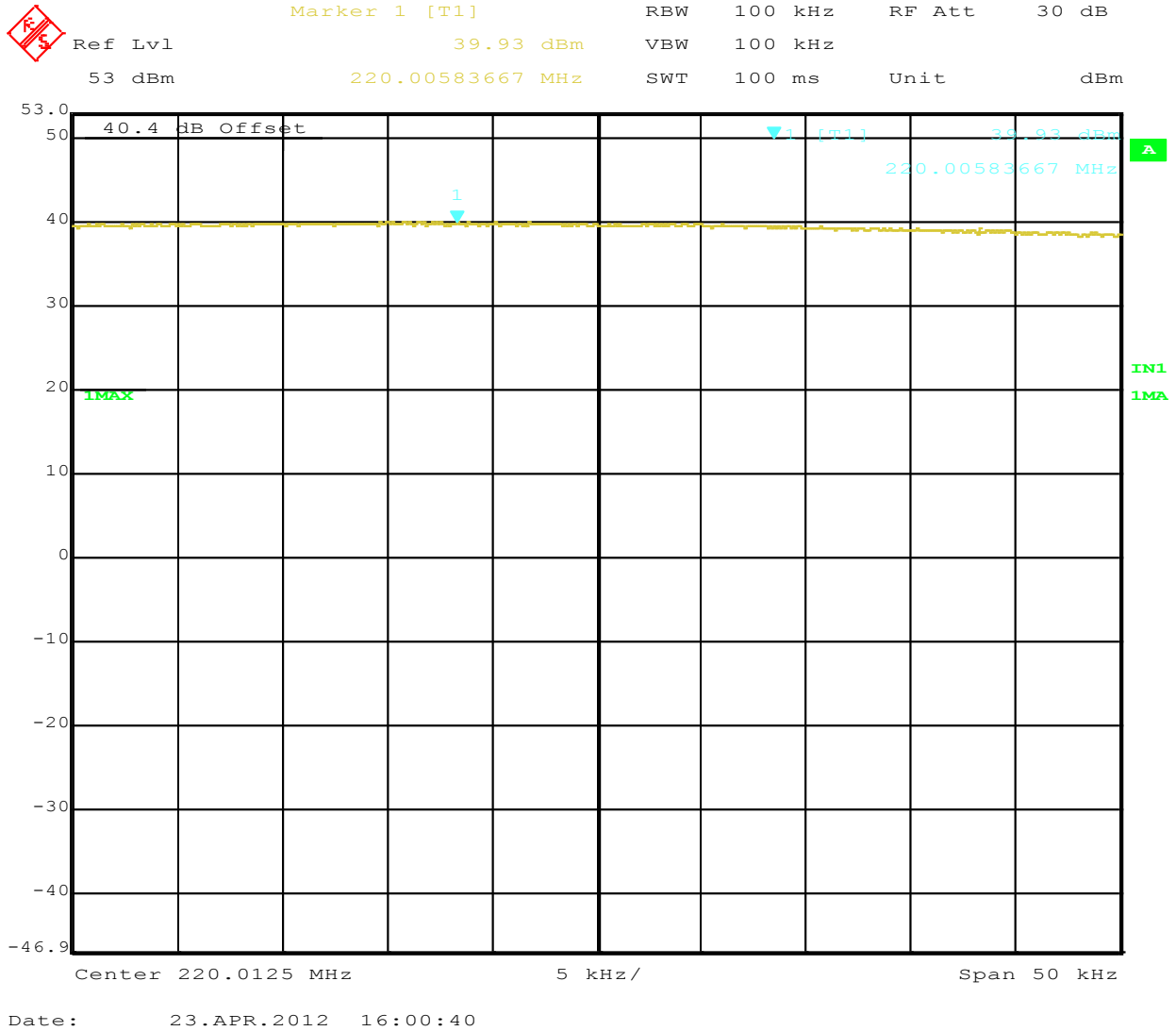
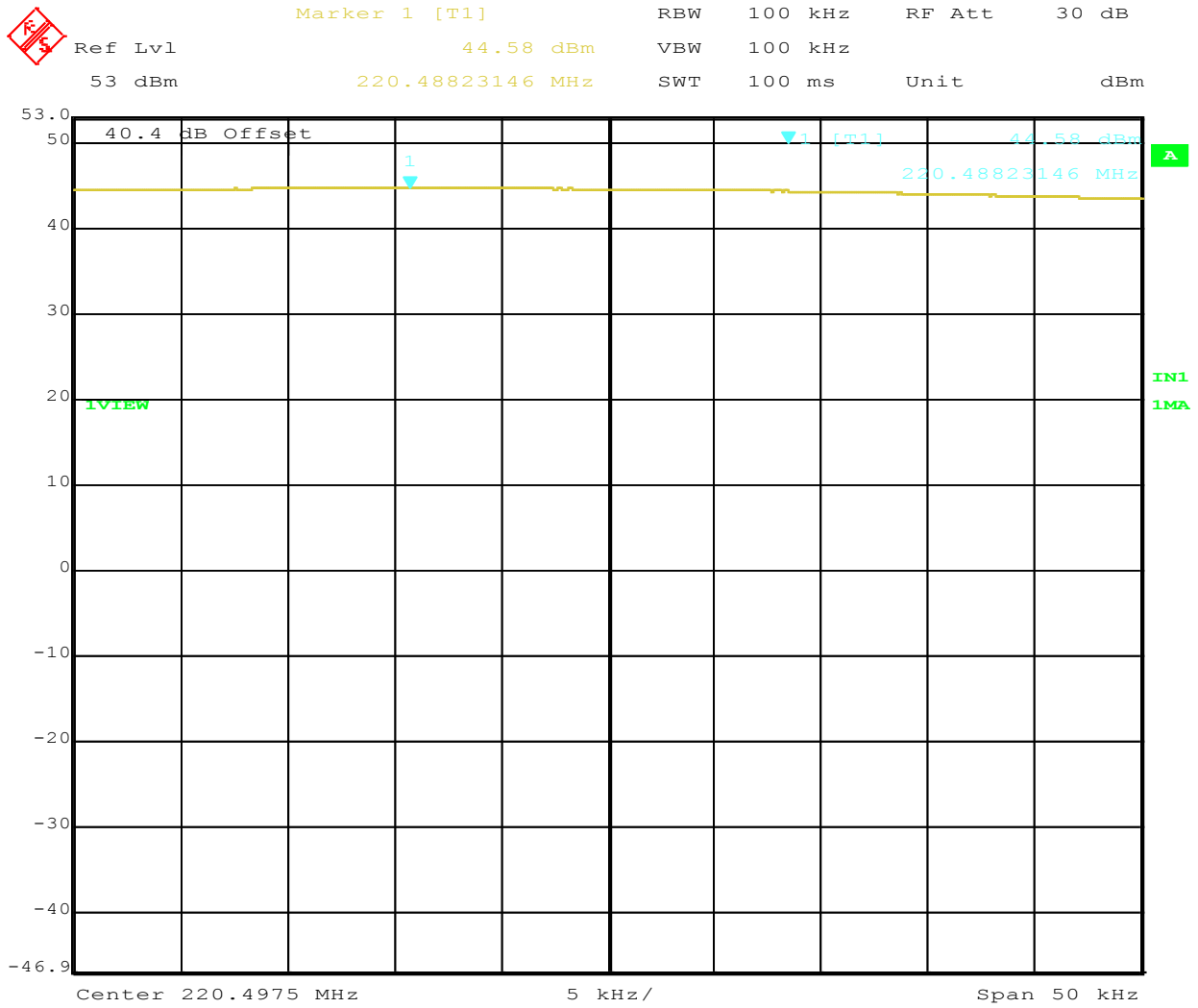

Figure 12: Maximum Transmitted Power, 220.0125MHz 32QPSK



Date: 23.APR.2012 15:45:51

Figure 13: Maximum Transmitted Power, 220.4875MHz GMSK

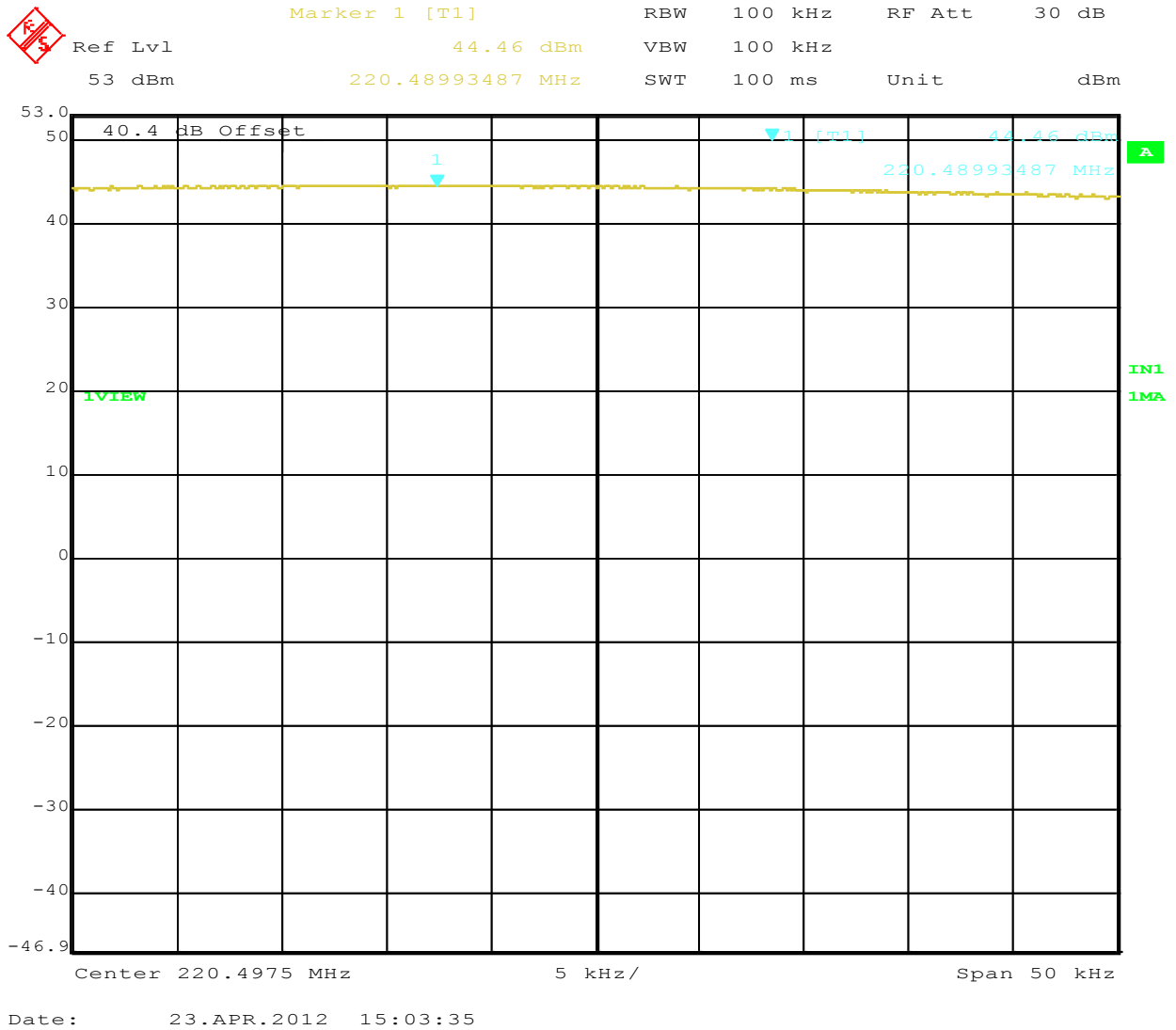
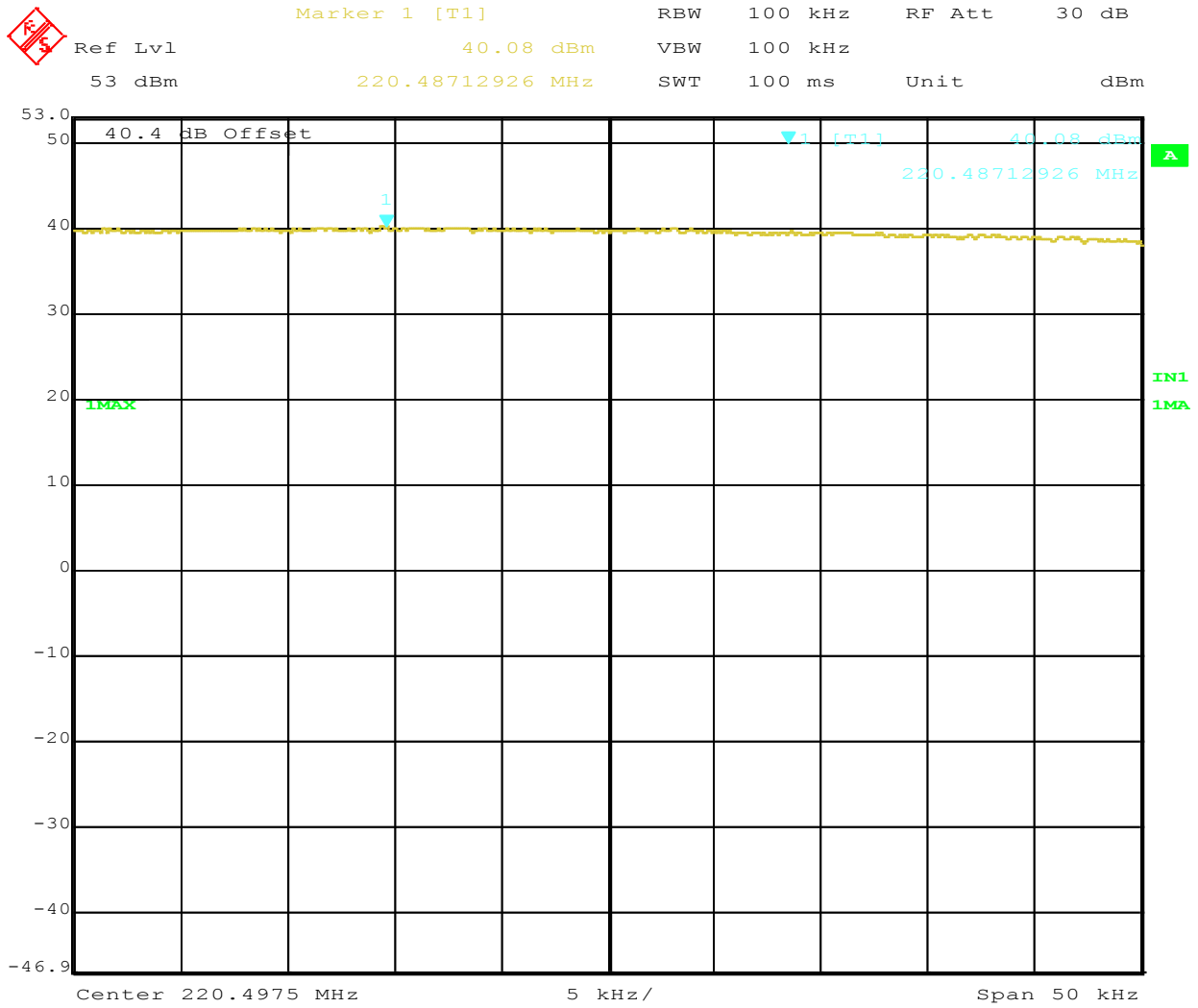

Figure 14: Maximum Transmitted Power, 220.4875MHz 16QPSK



Date: 23.APR.2012 15:59:28

Figure 15: Maximum Transmitted Power, 220.4875MHz 32QPSK

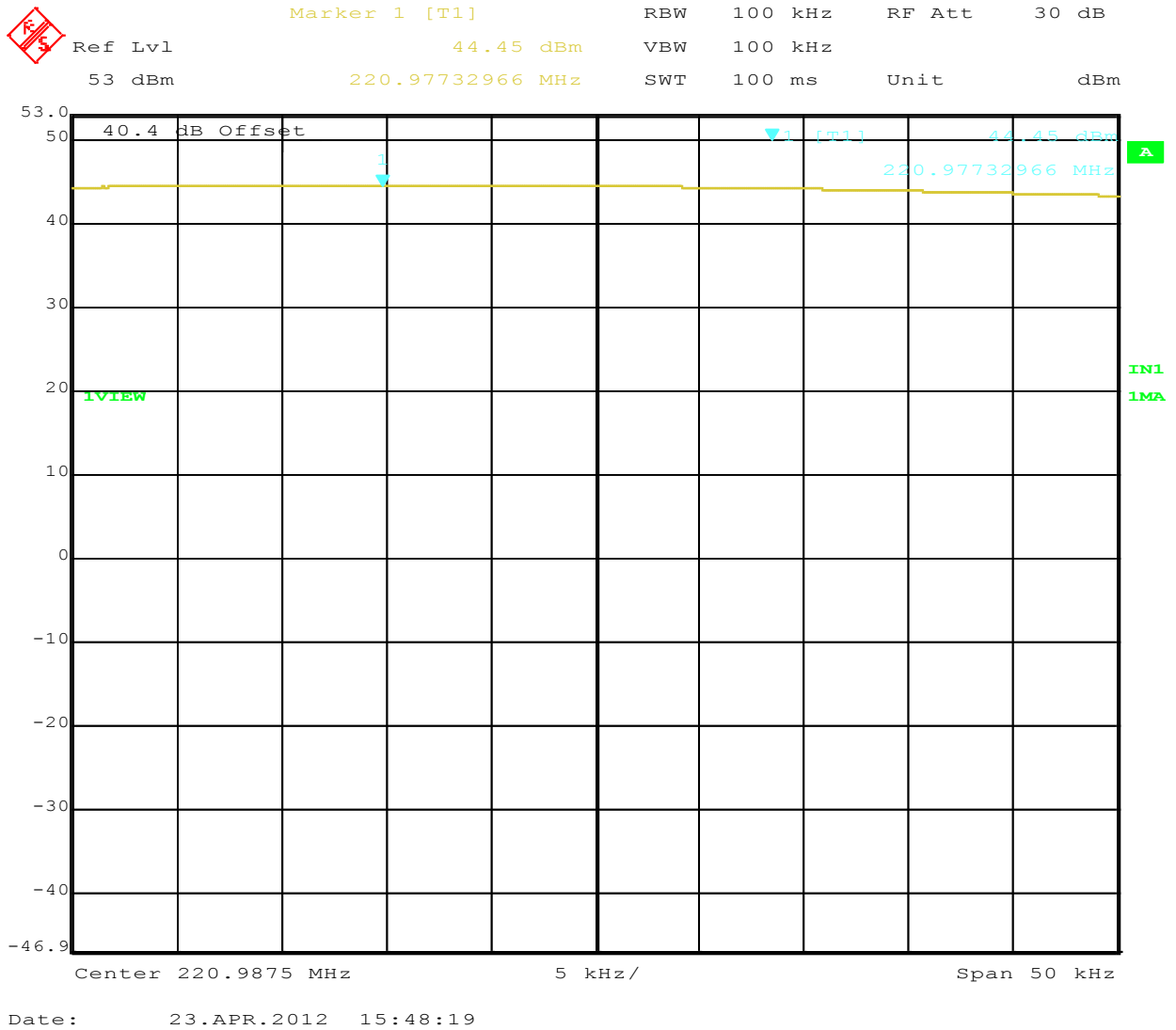
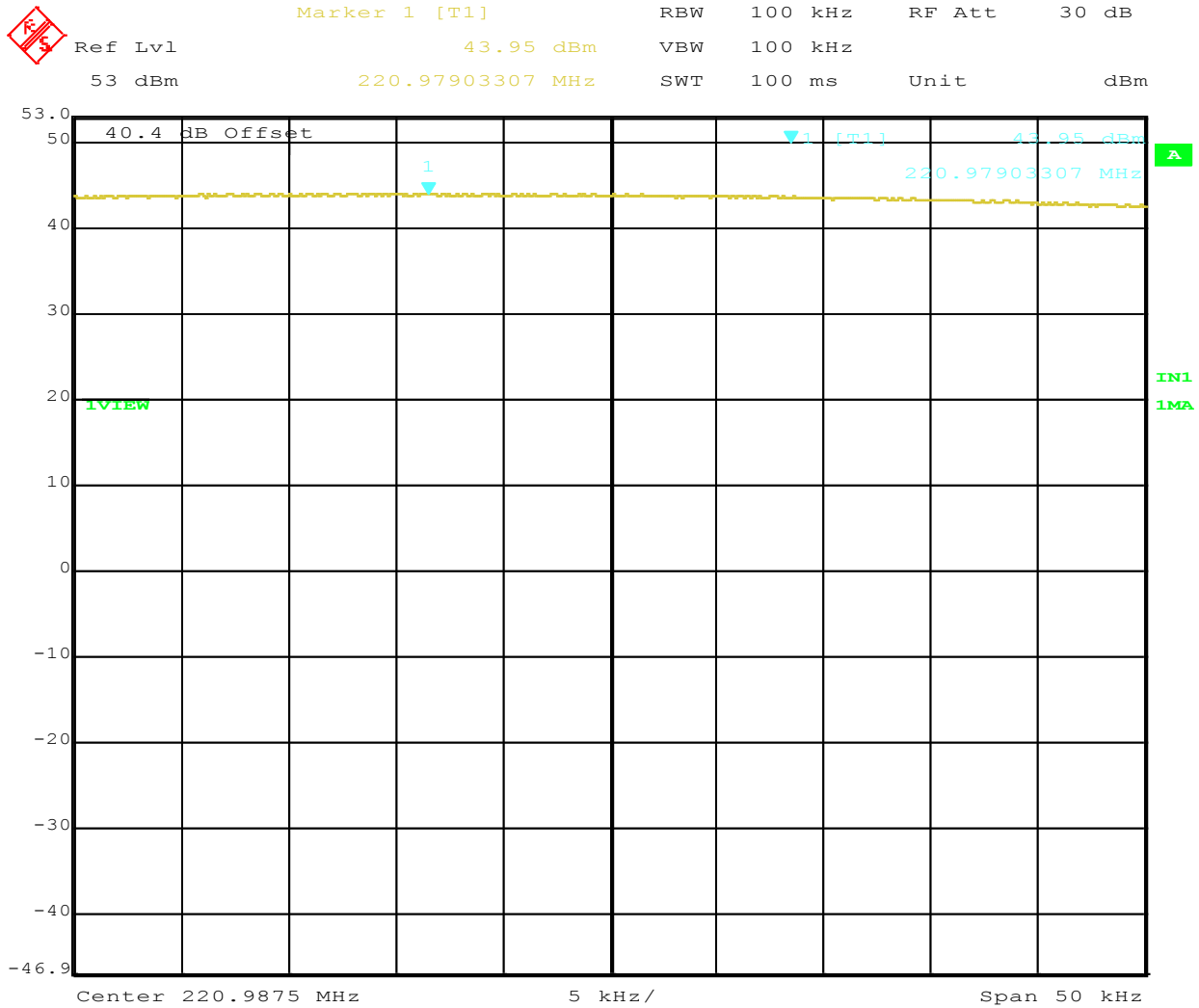

Figure 16: Maximum Transmitted Power, 220.9875 GMSK



Date: 23.APR.2012 15:05:49

Figure 17: Maximum Transmitted Power, 220.9875 16QPSK

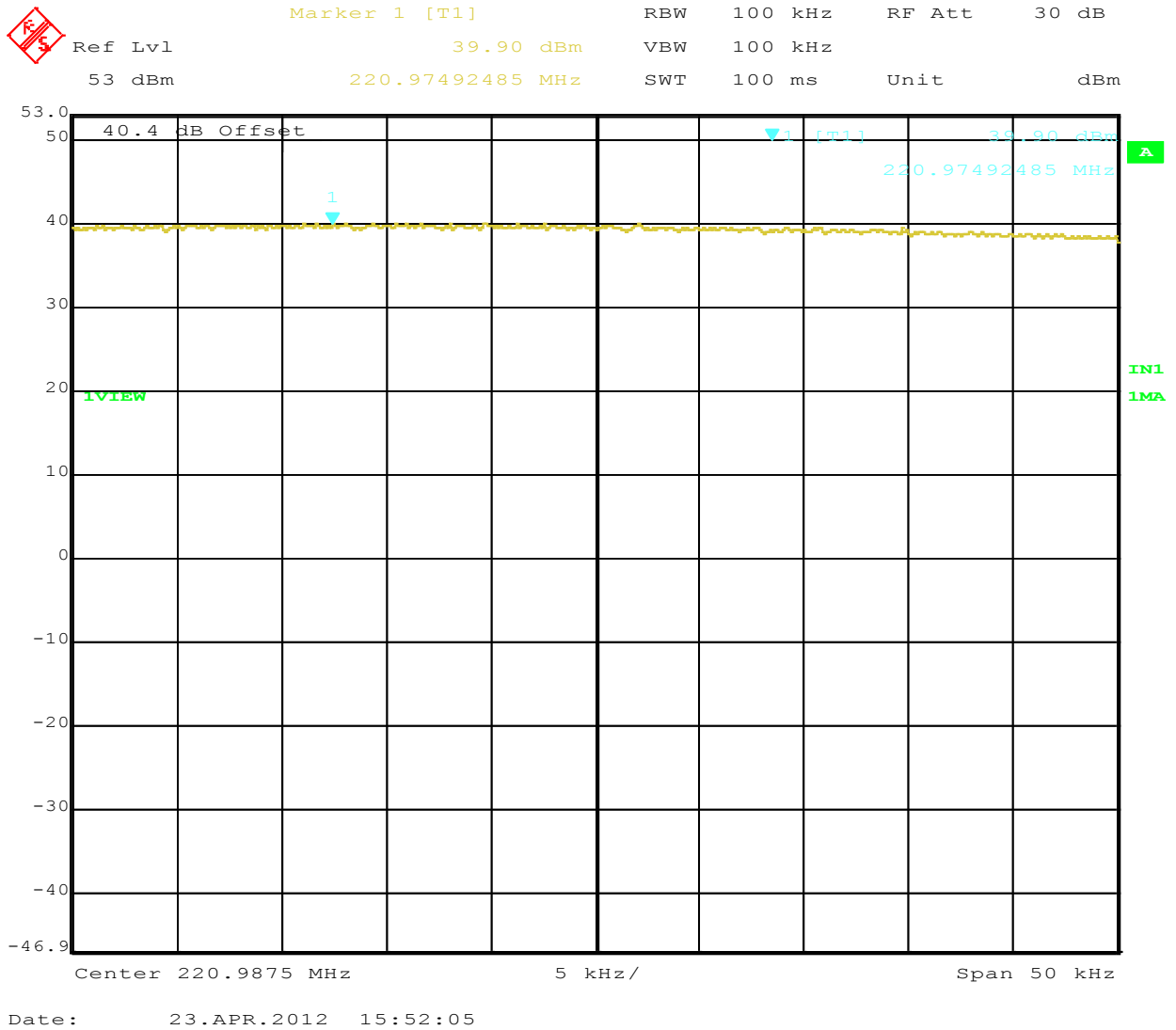

Figure 18: Maximum Transmitted Power, 220.9875 32QPSK

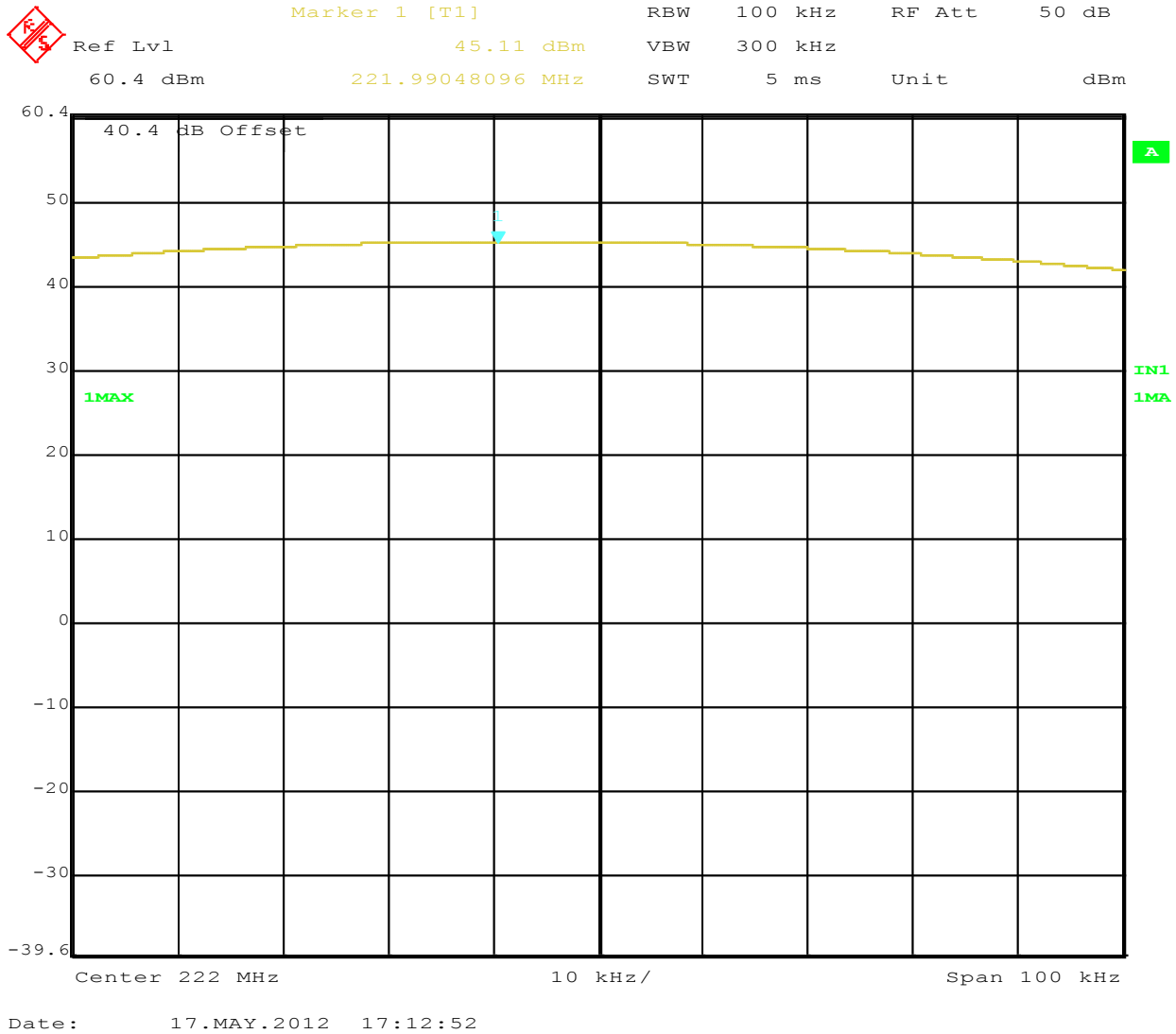

Figure 19: Maximum Transmitted Power, 222 MHz GMSK

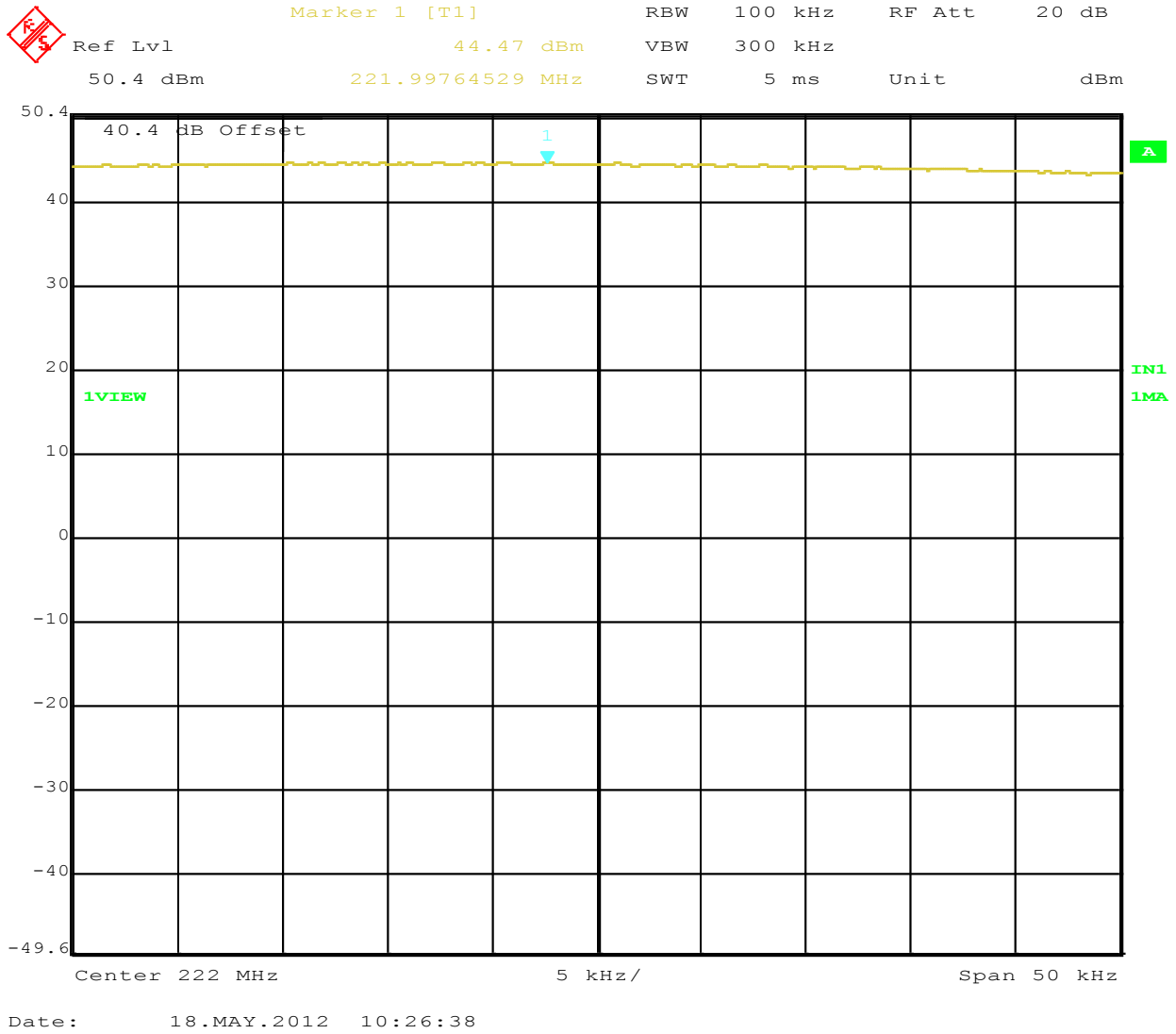

Figure 20: Maximum Transmitted Power, 222 MHz 16QPSK

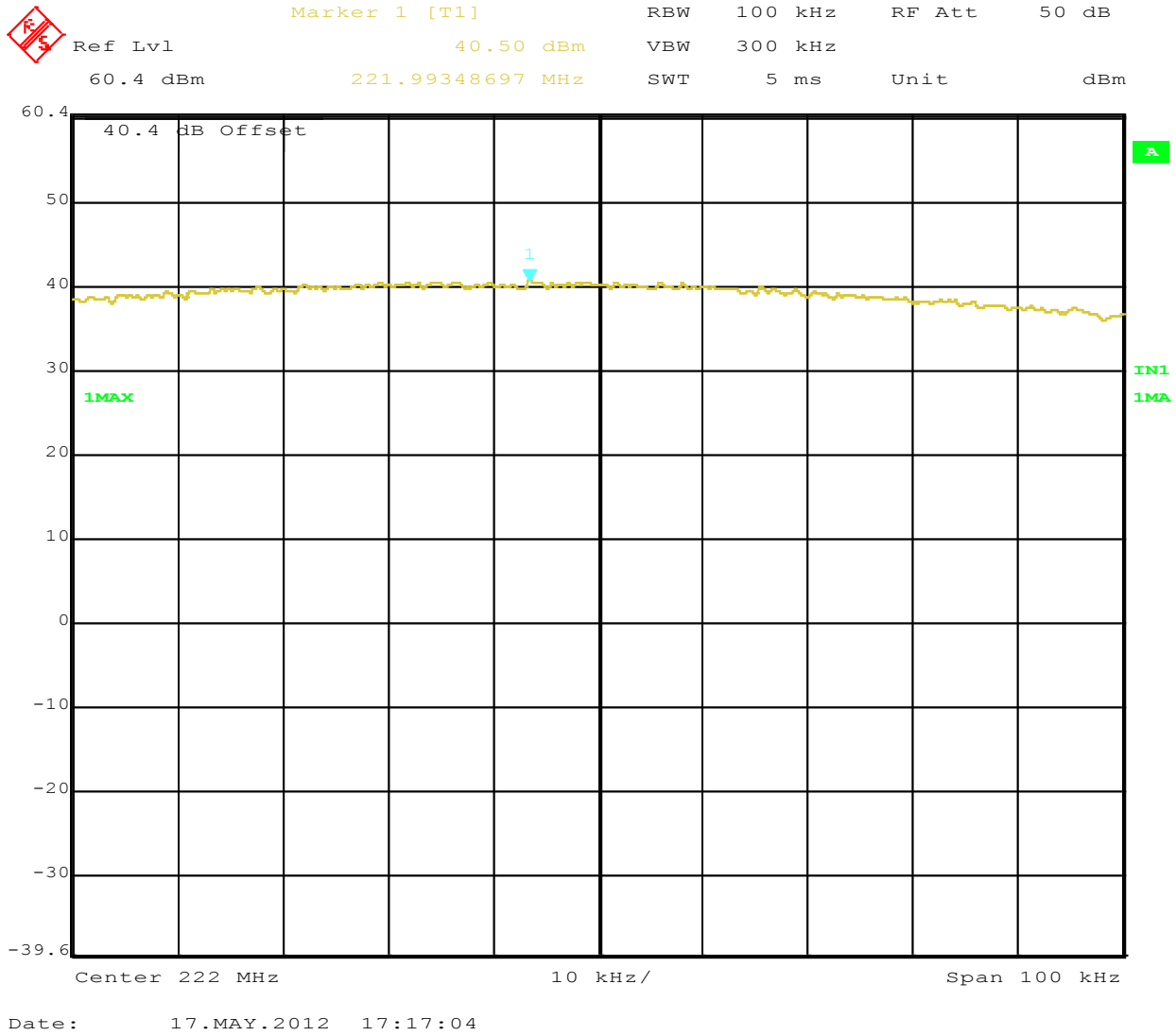

Figure 21: Maximum Transmitted Power, 222 MHz 32QPSK

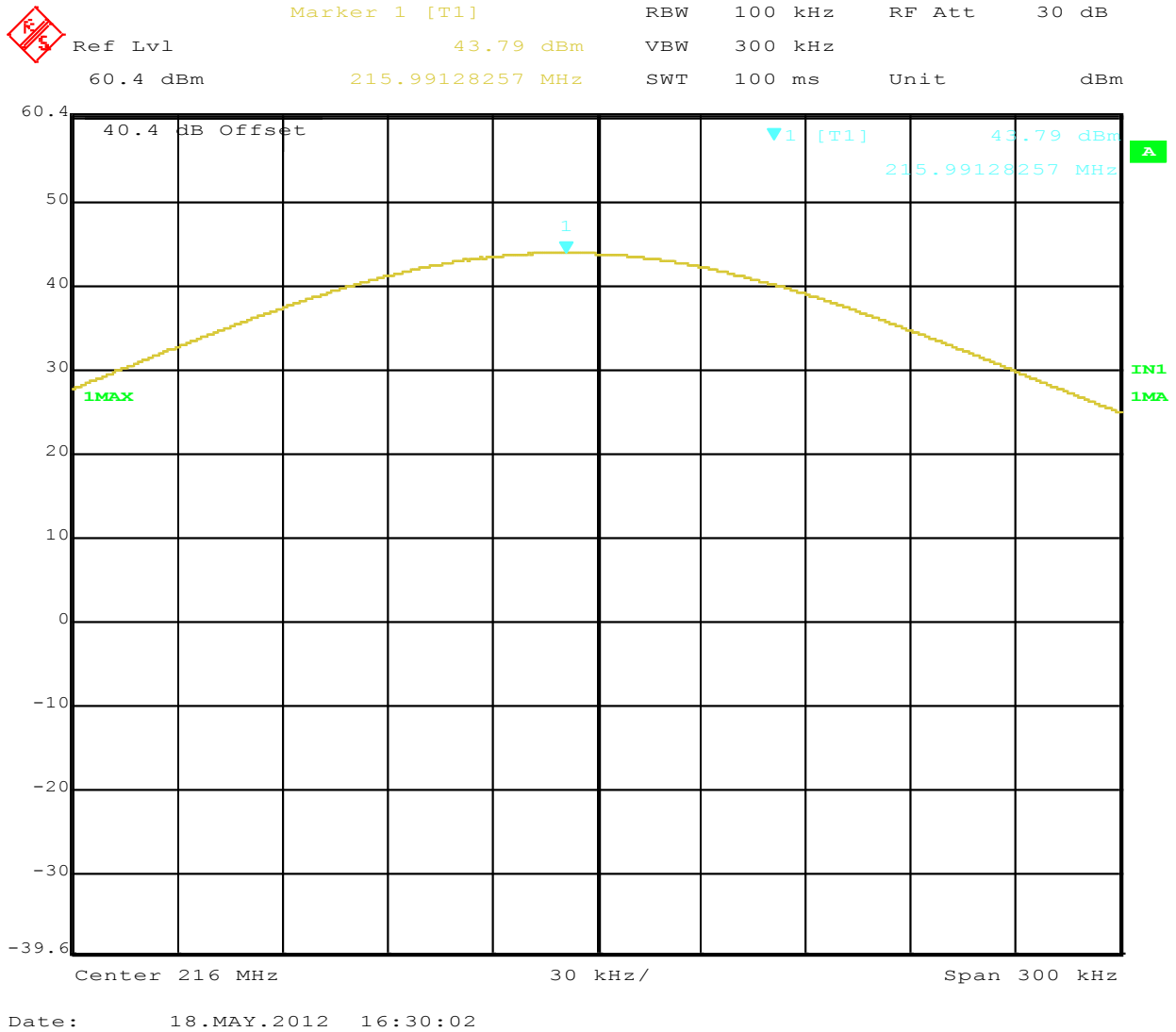

Figure 22: Maximum Transmitted Power, 216 MHz reduced power for Mobile application

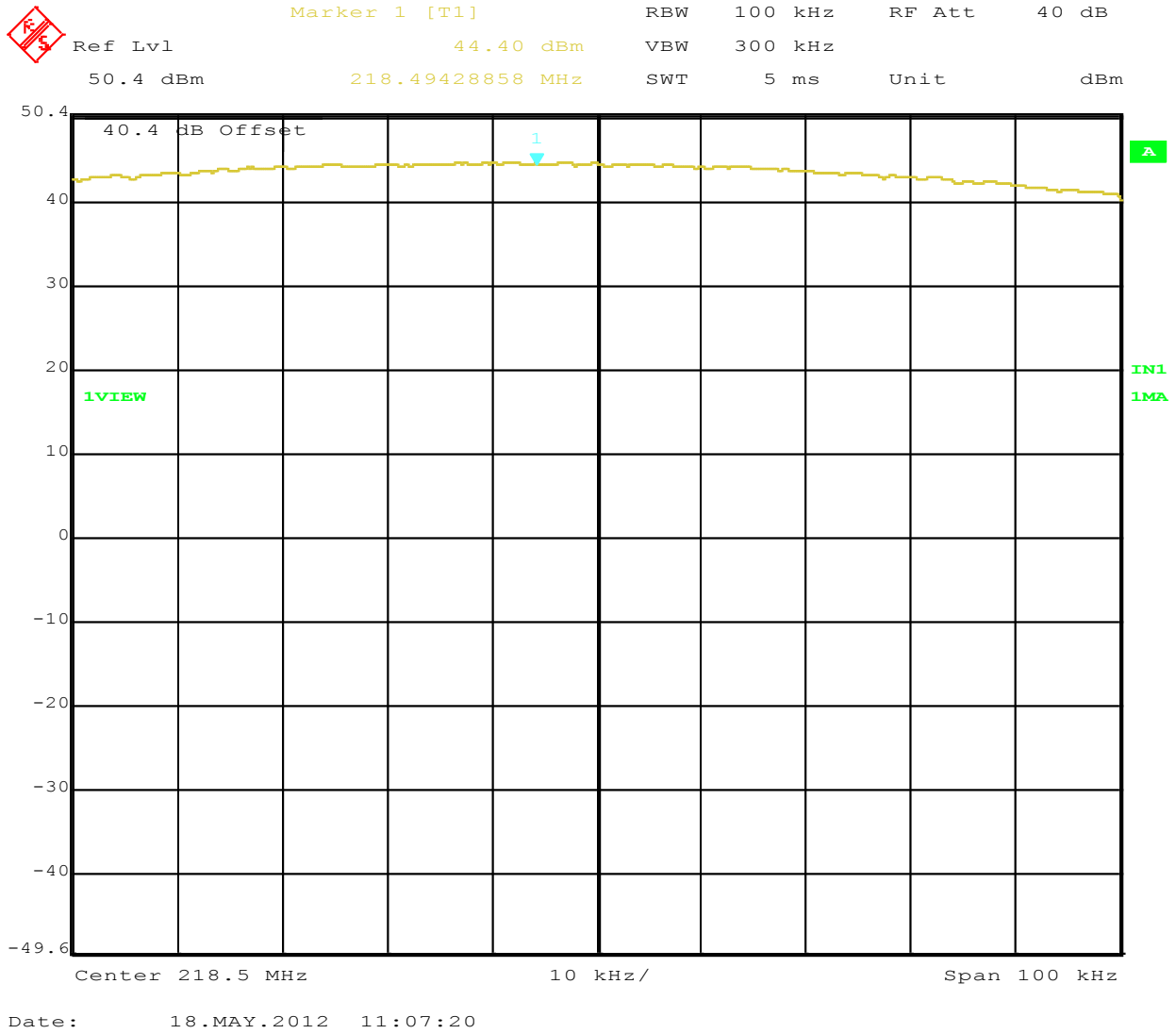

Figure 23: Maximum Transmitted Power, 218.5 MHz 16QPSK Power for Mobile application

4.2 Occupied Bandwidth

The occupied bandwidth is measured at an amplitude level reduced from the reference level by a specified ratio. The reference level is the level of the highest amplitude signal observed from the transmitter at the fundamental frequency.

The 99% bandwidth is the bandwidth in which 99% of the transmitted power occupied.

The 26 dB bandwidth is defined the bandwidth of 26 dB from highest transmitted level of the fundamental frequency.

4.2.1 Test Method

The conducted method was used to measure the occupied bandwidth. The measurement was performed with modulation per CFR47 Part 90.209 & 90.259 and RSS 119. Initial investigation was performed at different data rates and TX chains. The narrowest bandwidths at each operational mode were measured on 3 operating channels. The worst sample result indicated below.

Test Setup:

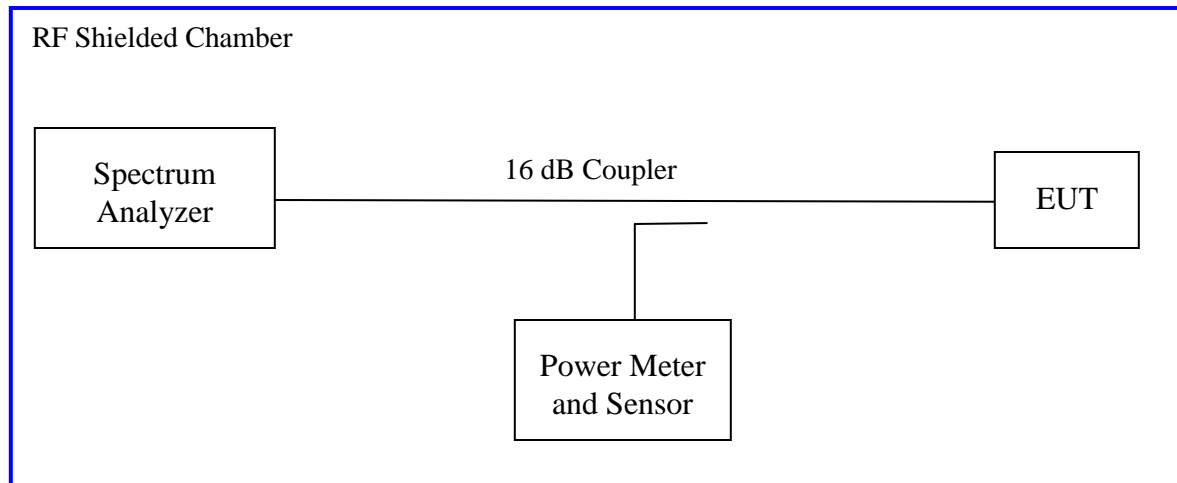

4.2.2 Results

As originally tested, the EUT was found to be compliant to the requirements of the test standard(s).

Table 3: Occupied Bandwidth – Test Results

Test Conditions: Conducted Measurement, Normal Temperature and Voltage only					
Antenna Type: External			Power Setting: See test plan		
Max. Antenna Gain: 3 dBi for Mobile and 14.1 dBi for Base Station			Signal State: Modulated		
Ambient Temp.: 21 °C			Relative Humidity: 33%		
Bandwidth (KHz)					
Freq. (MHz)	Modulation/ Data rate	26 dB BW	99% Occupied BW	RSS119 Limit (kHz)	Results
216.0	GMSK 9600	12.0	8.91	11.25	Pass
	16QPSK	19.8	10.62	11.25	Pass
	32QPSK	35.2	22.14	25.0	Pass
217.5	GMSK 9600	12.06	8.94	11.25	Pass
	16QPSK	13.69	10.13	11.25	Pass
	32QPSK	34.86	23.29	25.0	Pass
218.5	GMSK 9600	11.97	8.92	11.25	Pass
	16QPSK	19.78	10.34	11.25	Pass
	32QPSK	36.56	23.93	25.0	Pass
220.0125	GMSK 9600	12.05	9.00	11.25	Pass
	16QPSK	13.6	8.91	11.25	Pass
	32QPSK	20.39	16.76	25.0	Pass
220.9875	GMSK 9600	12.19	9.00	11.25	Pass
	16QPSK	14.31	10.08	11.25	Pass
	32QPSK	21.01	16.76	25.0	Pass

222.00	GMSK 9600	12.00	8.917	11.25	Pass
	16QPSK	14.36	10.06	11.25	Pass
	32QPSK	21.04	16.83	25.0	Pass

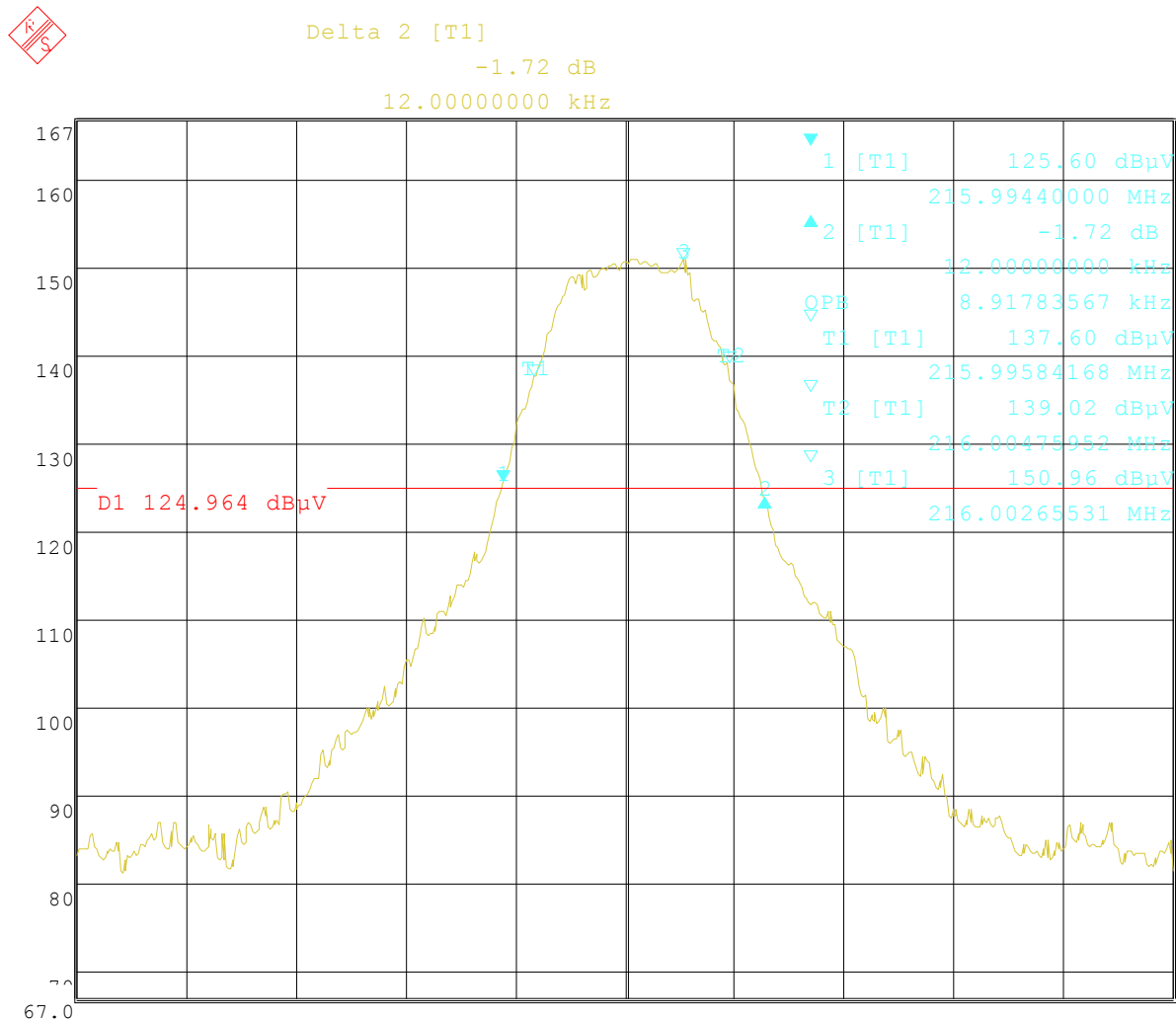

Date: 18.MAY.2012 16:25:40

Figure 24: Occupied Bandwidth at- Operating Channel 216.0 MHz GMSK

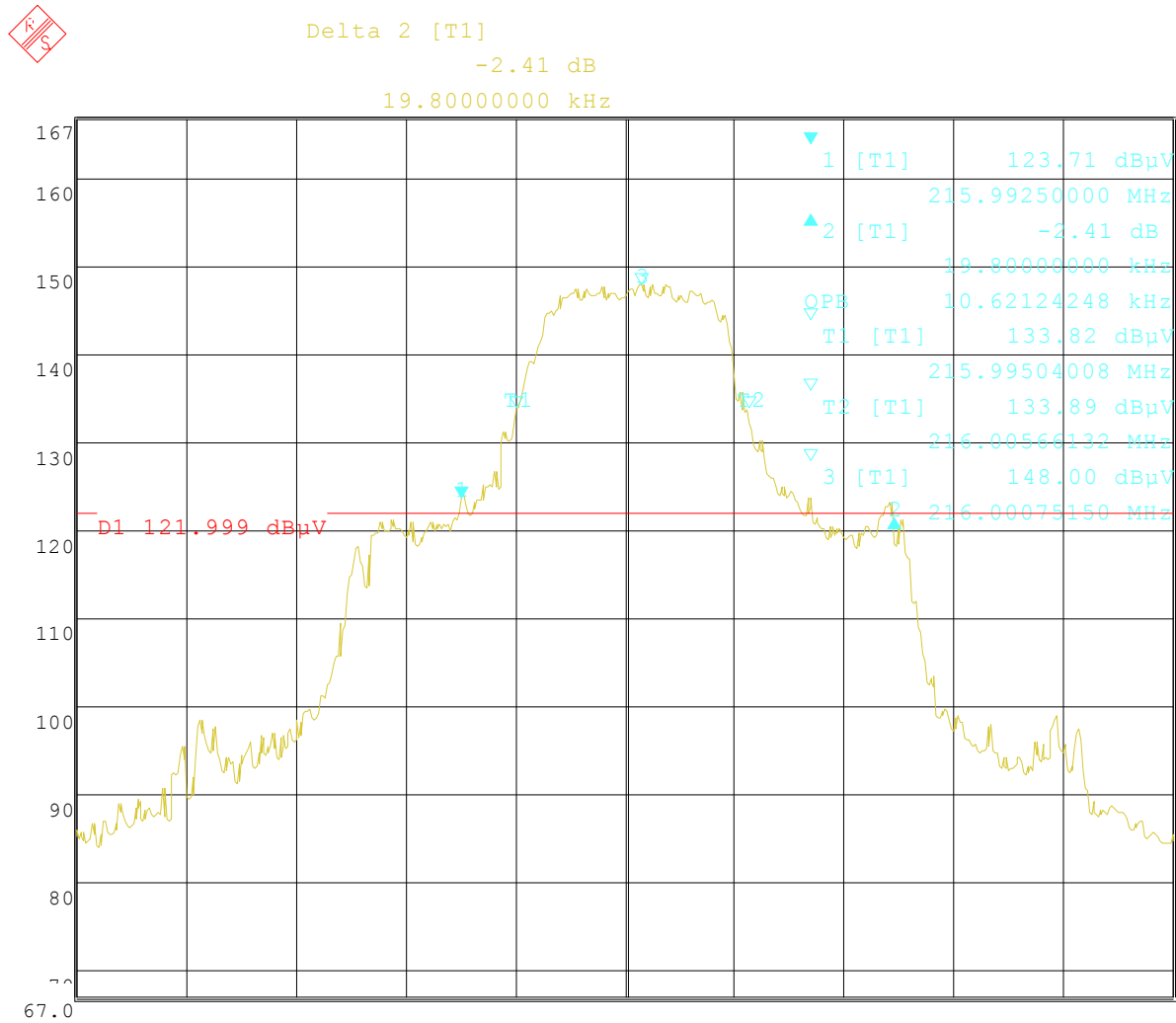

Date: 18.MAY.2012 16:02:12

Figure 25: Occupied Bandwidth at– Operating Channel 216.0 MHz 16QPSK

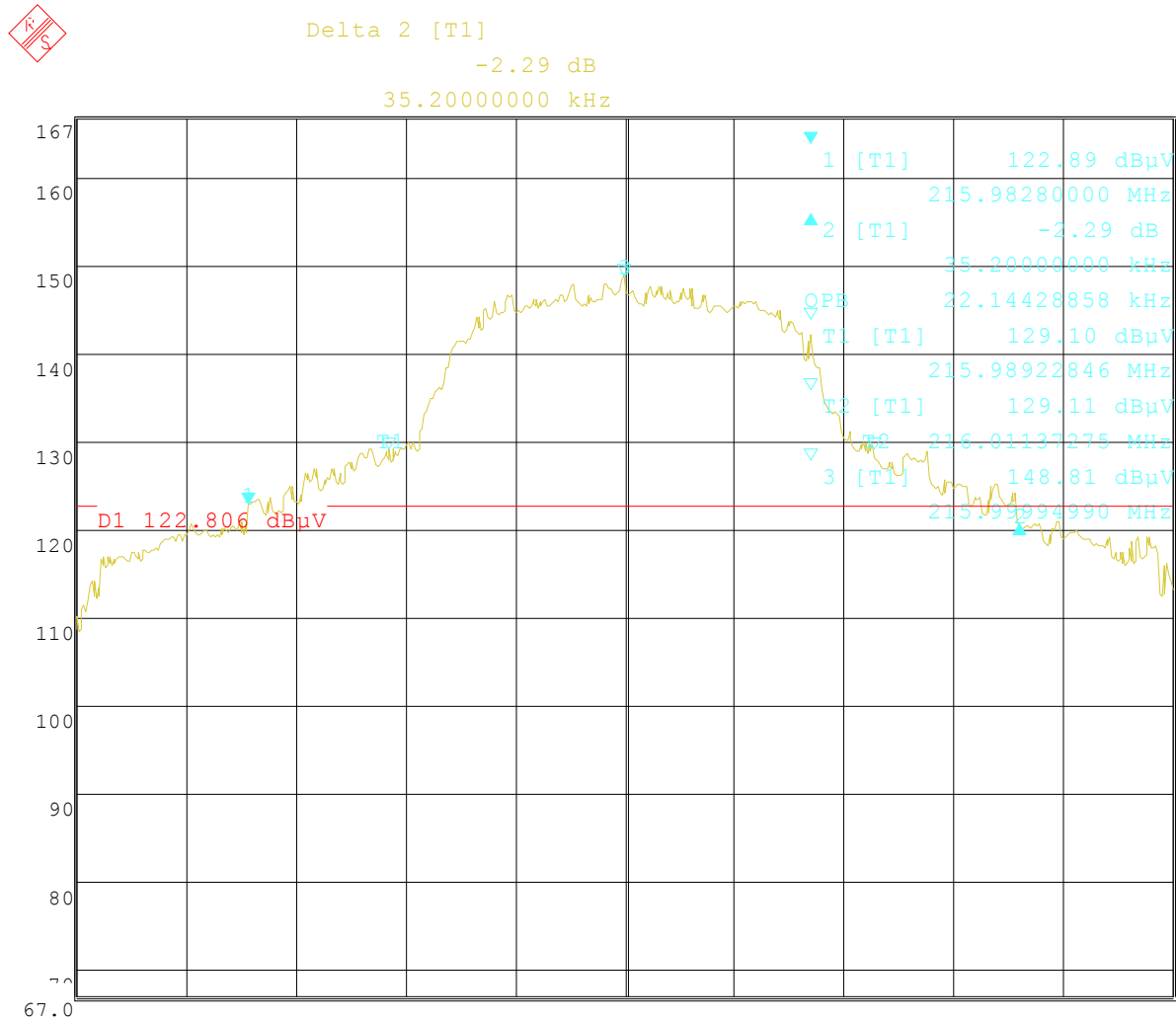

Date: 18.MAY.2012 16:23:28

Figure 26: Occupied Bandwidth at— Operating Channel 216.0 MHz 32QPSK

Agilent 14:53:40 Apr 20, 2012

R T

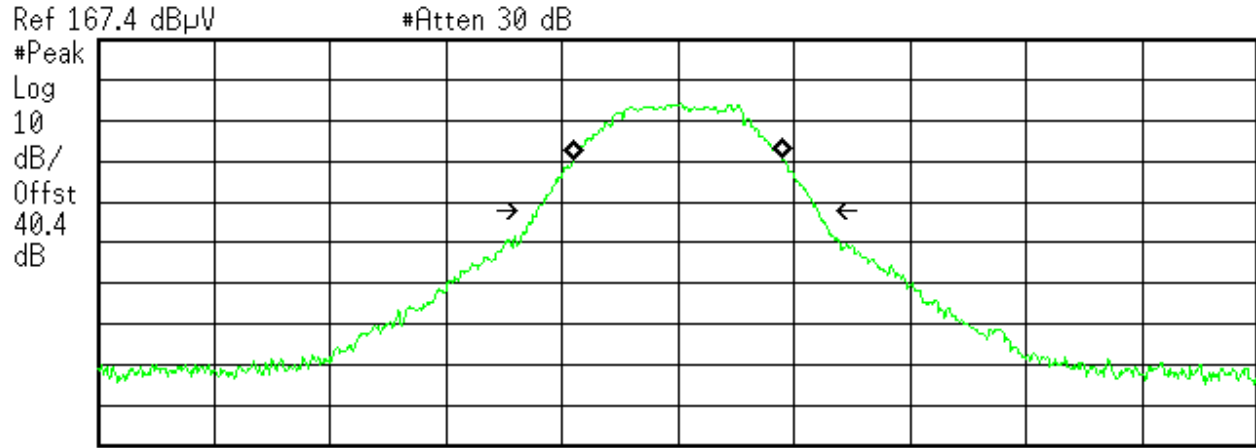

Center 217.5 MHz Span 50 kHz
#Res BW 1 kHz #VBW 3 kHz #Sweep 100 ms (1000 pts)

Occupied Bandwidth
8.9468 kHz

Occ BW % Pwr 99.00 %
x dB -26.00 dB

Transmit Freq Error 6.617 Hz
x dB Bandwidth 12.066 kHz

Figure 27: Occupied Bandwidth at- Operating Channel 217.5 MHz GMSK

Agilent 15:30:06 Apr 20, 2012

R T

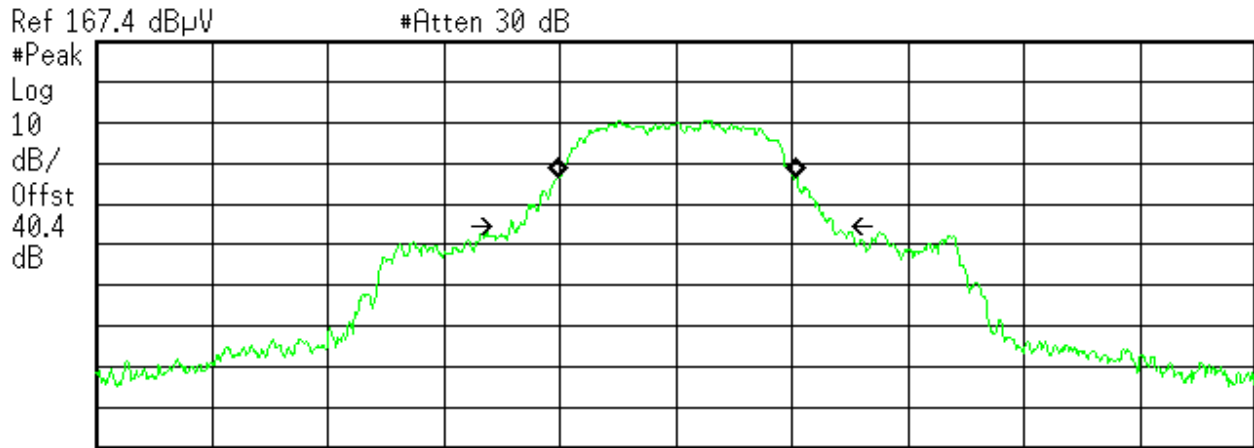

Center 217.5 MHz Span 50 kHz
 #Res BW 1 kHz #VBW 3 kHz #Sweep 100 ms (1000 pts)

Occupied Bandwidth
 10.1320 kHz

Occ BW % Pwr 99.00 %
x dB -26.00 dB

Transmit Freq Error 9.031 Hz
x dB Bandwidth 13.699 kHz

Figure 28: Occupied Bandwidth at– Operating Channel 217.5 MHz 16QPSK

Agilent 14:58:33 Apr 20, 2012

R T

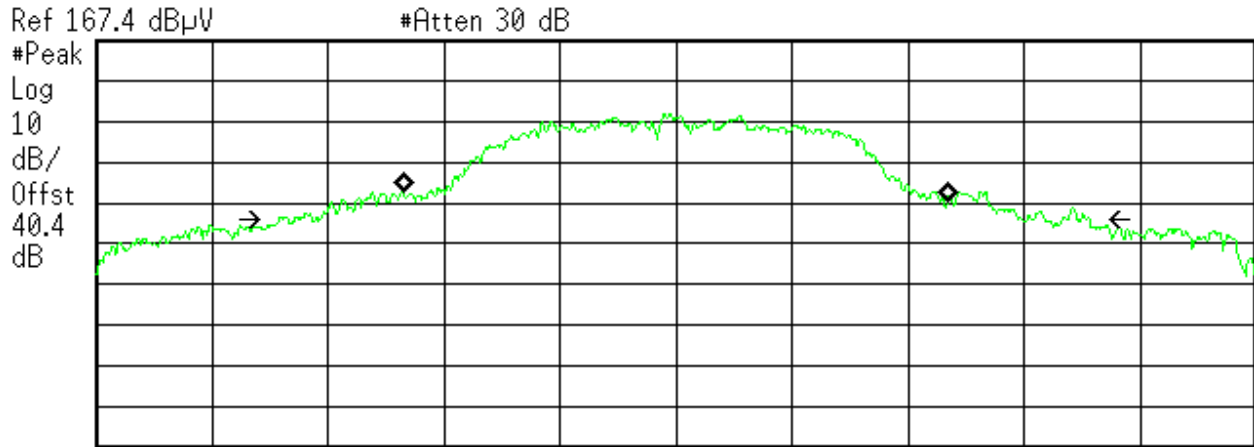

Center 217.5 MHz Span 50 kHz
 #Res BW 1 kHz #VBW 3 kHz #Sweep 100 ms (1000 pts)

Occupied Bandwidth
 23.2972 kHz

Occ BW % Pwr 99.00 %
x dB -26.00 dB

Transmit Freq Error -67.422 Hz
x dB Bandwidth 34.863 kHz

Figure 29: Occupied Bandwidth at- Operating Channel 217.5 MHz 32QPSK

Agilent 14:45:56 Apr 20, 2012

R T

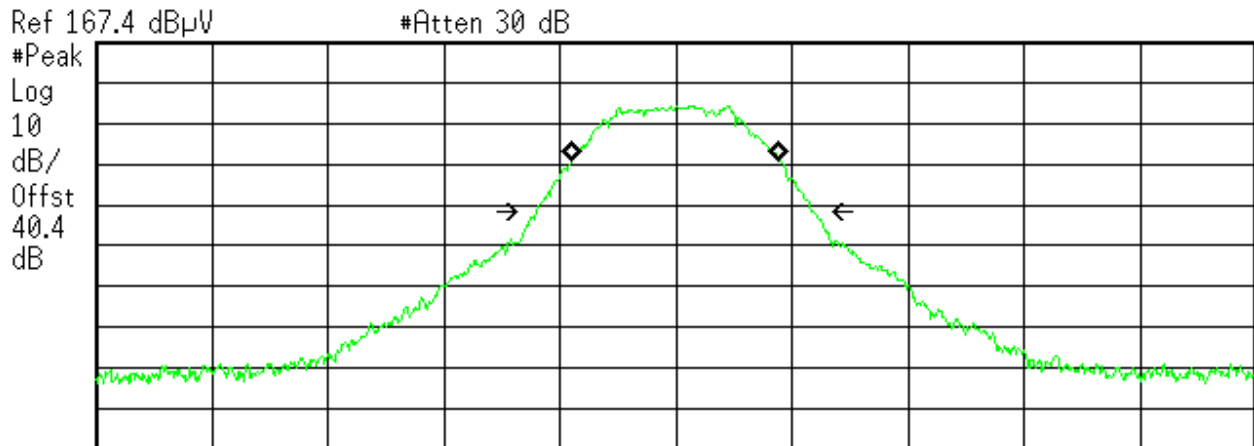

Center 218.5 MHz #Res BW 1 kHz #Atten 30 dB #VBW 3 kHz #Sweep 100 ms (1000 pts) Span 50 kHz

Occupied Bandwidth
 8.9284 kHz

Occ BW % Pwr 99.00 %
Occupied Bandwidth -26.00 dB

Transmit Freq Error -31.695 Hz
x dB Bandwidth 11.970 kHz

Figure 30: Occupied Bandwidth at- Operating Channel 218.5 MHz GMSK

Agilent 15:17:55 Apr 20, 2012

R T

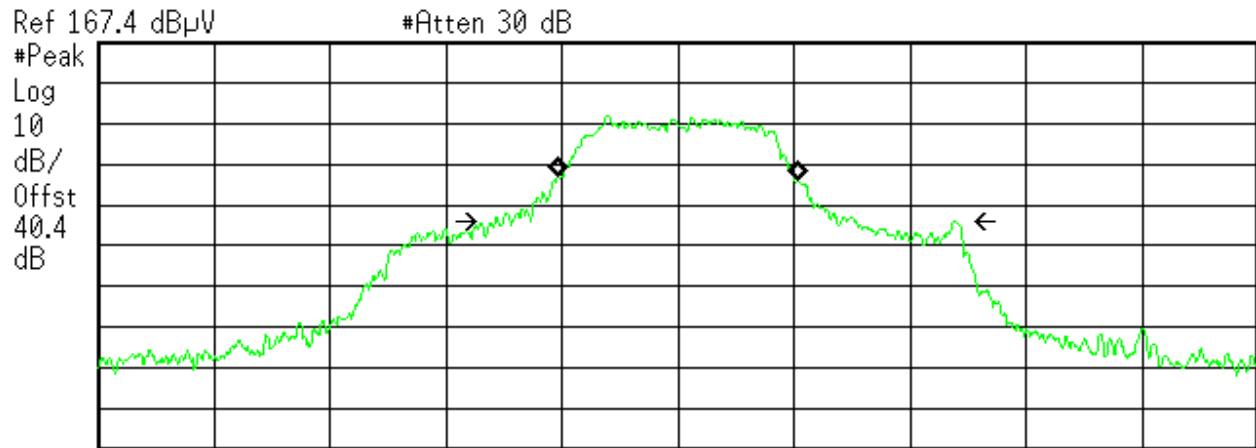

Center 218.5 MHz Span 50 kHz
#Res BW 1 kHz #VBW 3 kHz #Sweep 100 ms (1000 pts)

Occupied Bandwidth
10.3497 kHz

Occ BW % Pwr 99.00 %
x dB -26.00 dB

Transmit Freq Error -13.608 Hz
x dB Bandwidth 19.781 kHz

Figure 31: Occupied Bandwidth at- Operating Channel 218.5 MHz 16QPSK

Agilent 14:50:17 Apr 20, 2012

R T

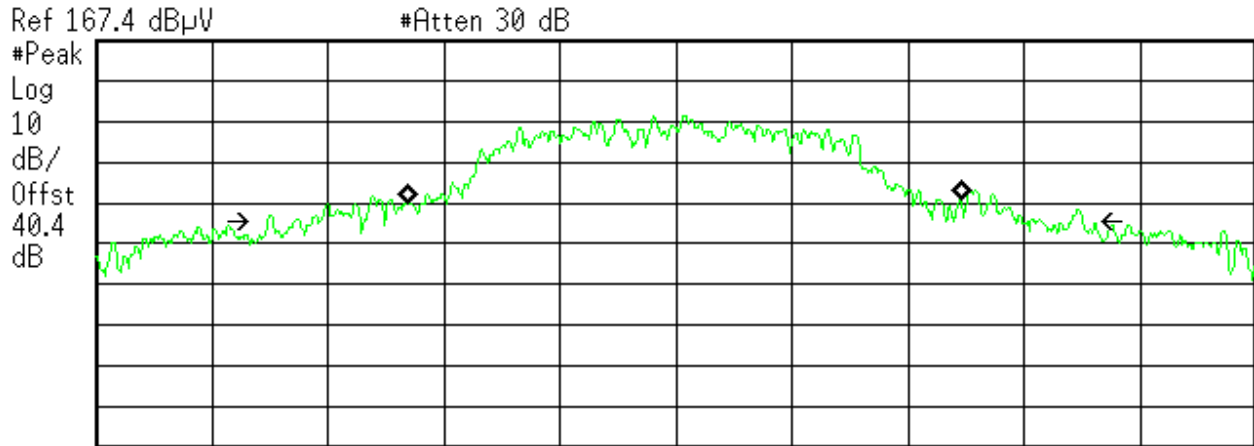

Center 218.5 MHz Span 50 kHz
 #Res BW 1 kHz #VBW 3 kHz #Sweep 100 ms (1000 pts)

Occupied Bandwidth
 23.9312 kHz

Occ BW % Pwr 99.00 %
x dB -26.00 dB

Transmit Freq Error 288.958 Hz
x dB Bandwidth 36.567 kHz

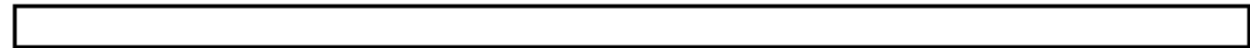
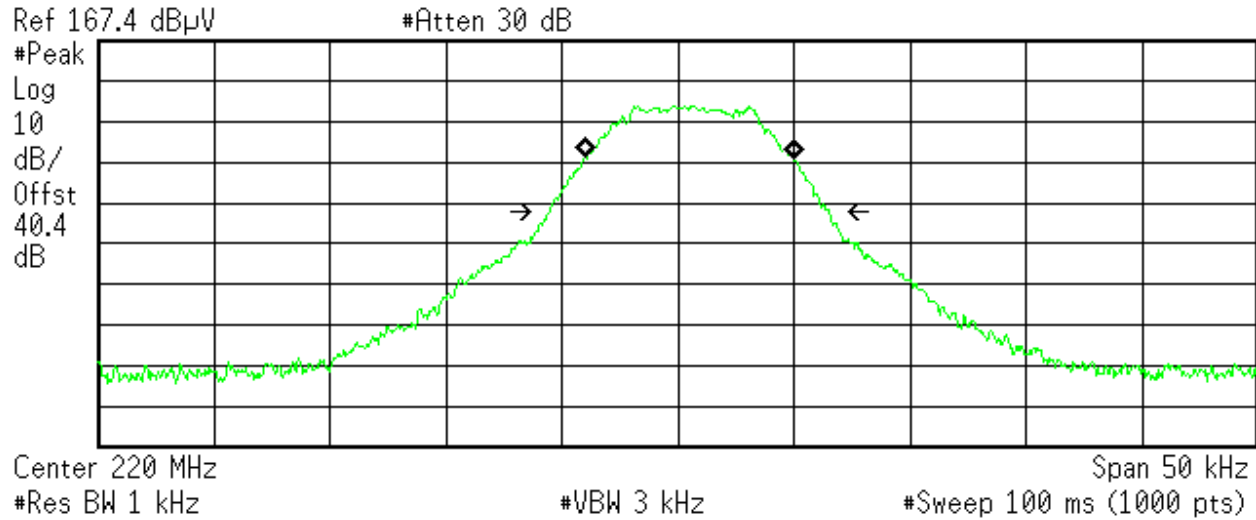

Figure 32: Occupied Bandwidth at- Operating Channel 218.5 MHz 32QPSK

Agilent 14:23:27 Apr 20, 2012

R T



Occupied Bandwidth
 9.0001 kHz

Occ BW % Pwr 99.00 %
Occupied Bandwidth -26.00 dB

Transmit Freq Error 465.863 Hz
x dB Bandwidth 12.058 kHz

Figure 33: Occupied Bandwidth at- Operating Channel 220.0125 MHz GMSK

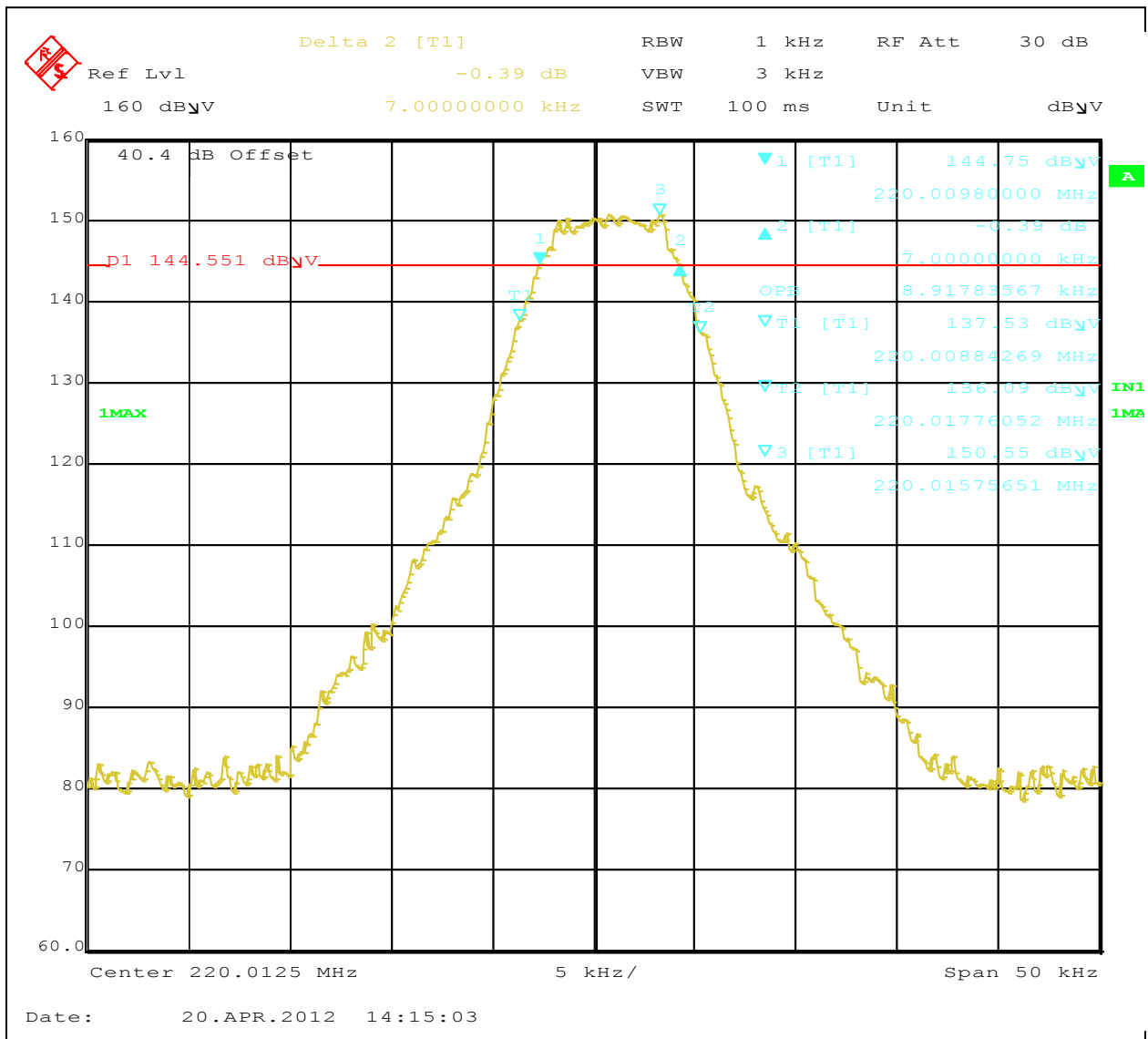
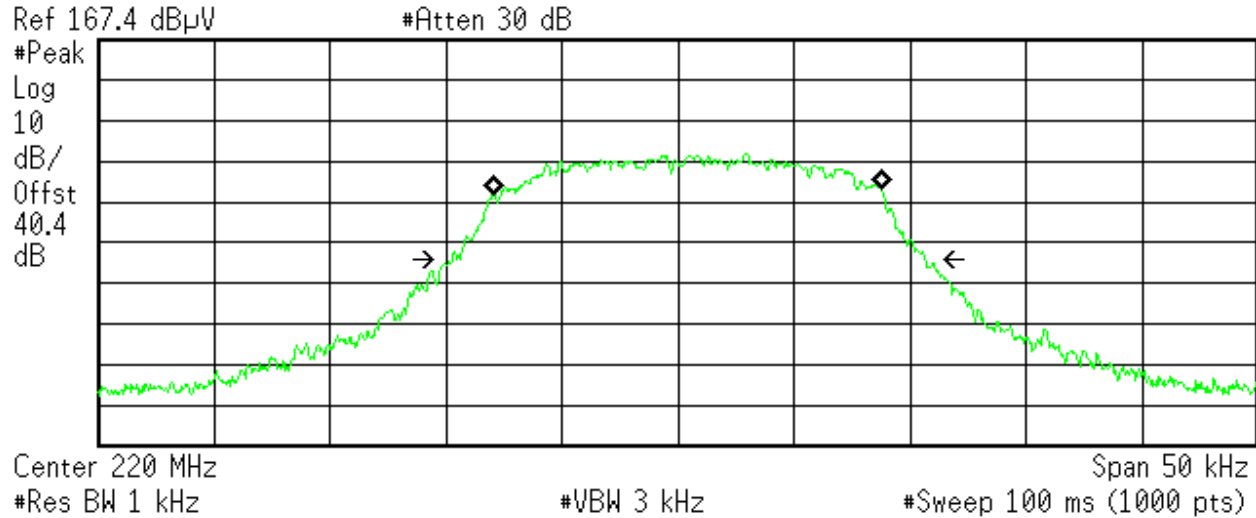

Figure 34: Occupied Bandwidth at- Operating Channel 220.0125 MHz 16QPSK

Agilent 14:26:38 Apr 20, 2012

R T



Occupied Bandwidth
 16.7649 kHz

Occ BW % Pwr 99.00 %
x dB -26.00 dB

Transmit Freq Error 408.554 Hz
x dB Bandwidth 20.396 kHz

Figure 35: Occupied Bandwidth at– Operating Channel 220.0125 MHz 32QPSK

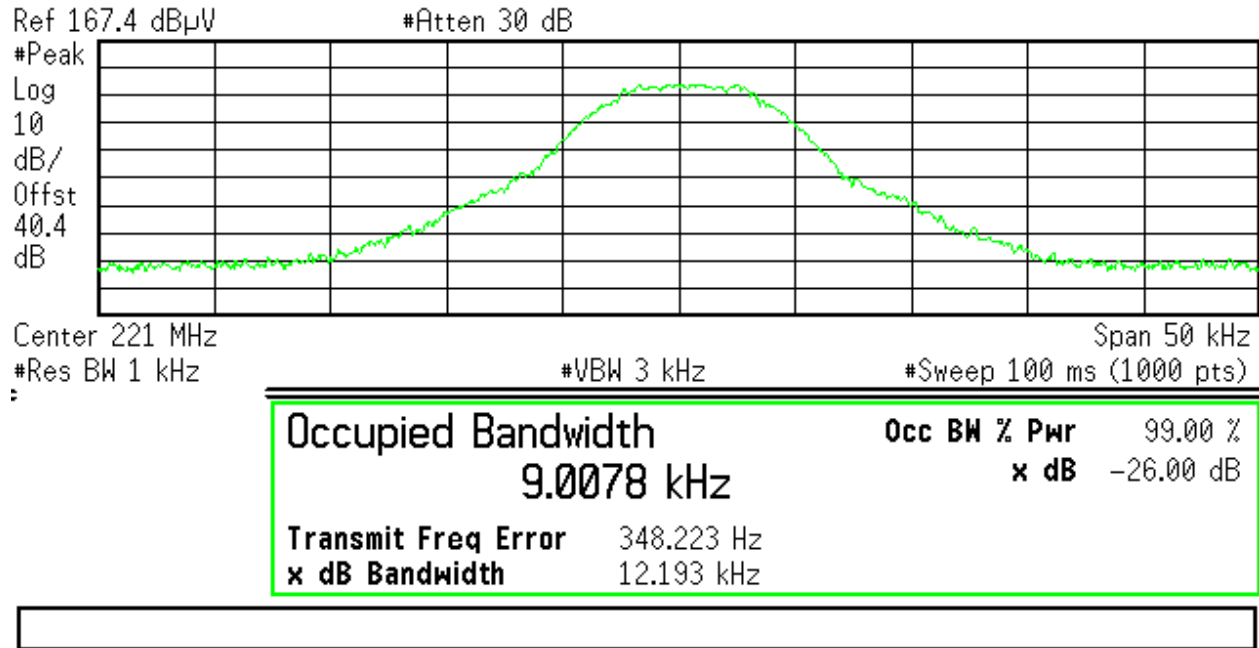
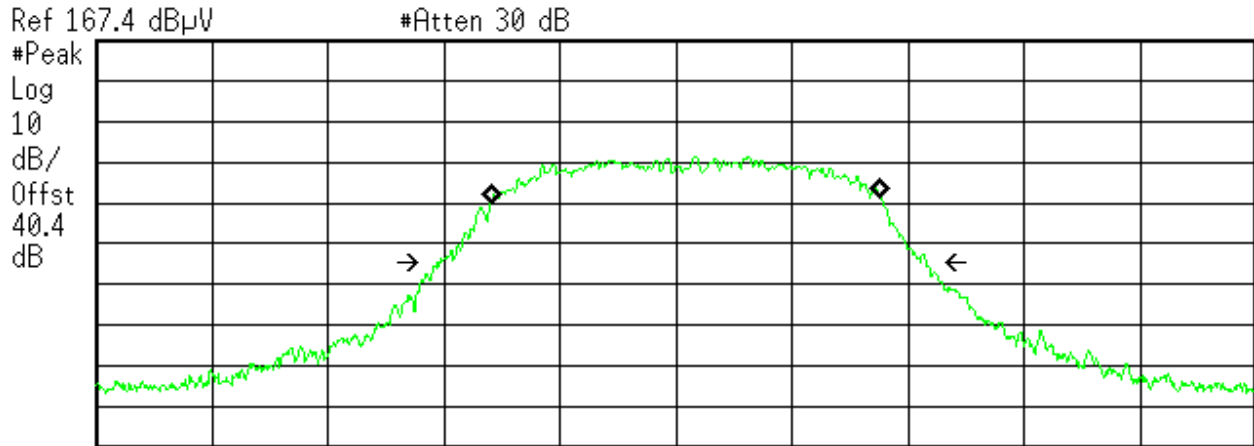

Figure 36: Occupied Bandwidth at– Operating Channel 220.9875 MHz 16QPSK

Agilent 14:31:41 Apr 20, 2012

R T



Center 221 MHz Span 50 kHz
 #Res BW 1 kHz #VBW 3 kHz #Sweep 100 ms (1000 pts)

Occupied Bandwidth
 16.7652 kHz

Occ BW % Pwr 99.00 %
x dB -26.00 dB

Transmit Freq Error 396.377 Hz
x dB Bandwidth 21.070 kHz

Figure 37: Occupied Bandwidth at- Operating Channel 220.9875 MHz 32QPSK

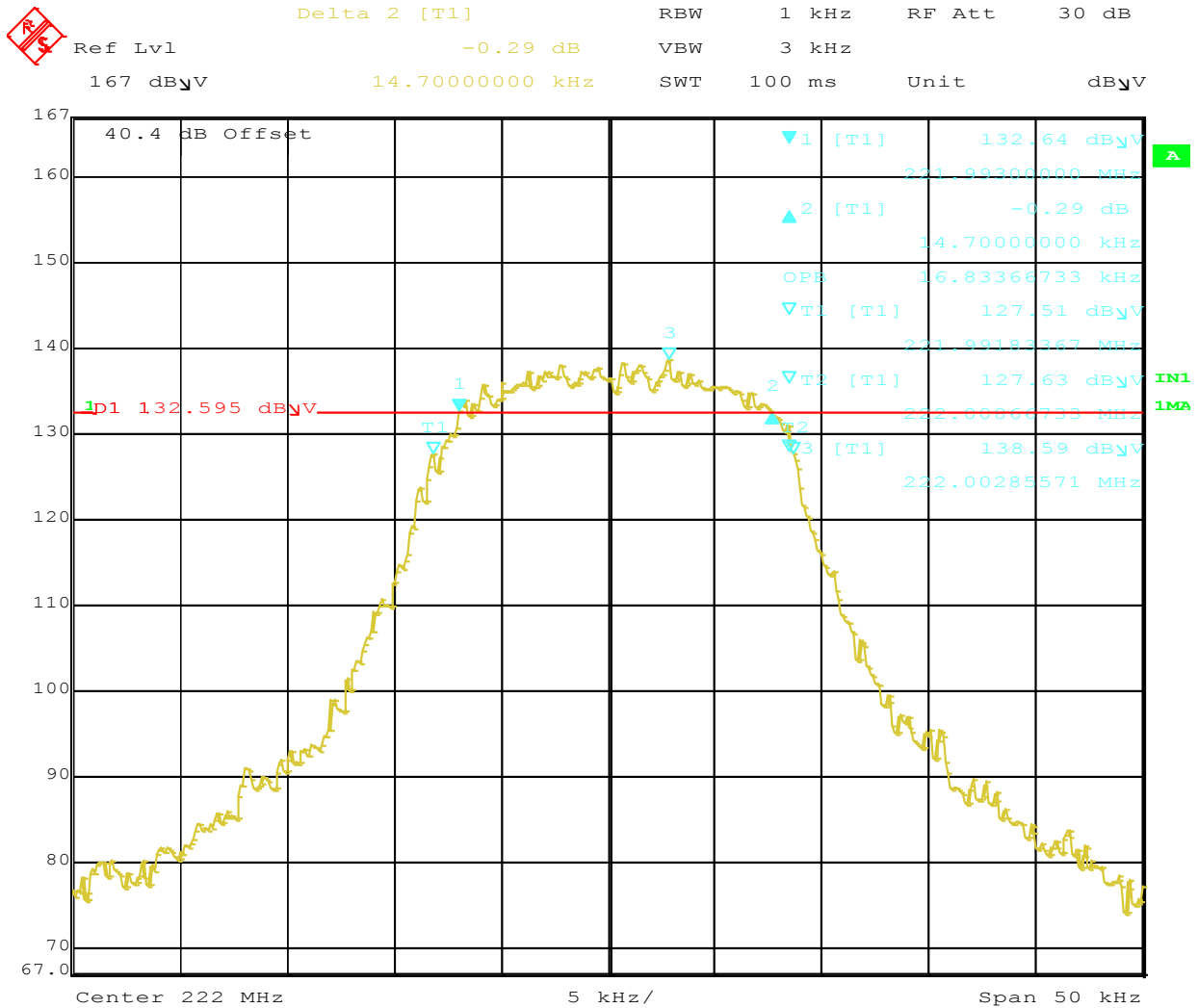

Date: 17.MAY.2012 17:58:48

Figure 38: Occupied Bandwidth at- Operating Channel 222 MHz 32QPSK

4.3 Spectral Mask requirements

4.3.1.1.1 90.210 Emission masks.

The transmitters used in the radio service governed by this part of radio service must comply

Applicable mask 216-220 MHz Mask C Part 90.210, RSS 119 table 3 Mask J

Applicable mask for 220-222 MHz Mask F Part 90.210, RSS 119 table 3 Mask F

c) **Emission Mask C.** For transmitters that are not equipped with an audio low-pass filter, the power of any emission must be attenuated below the unmodulated carrier output power (P) as follows:

- (1) On any frequency removed from the center of the authorized bandwidth by a displacement frequency (f_d in kHz) of more than 5 kHz, but not more than 10 kHz: At least $83 \log (f_d/5)$ dB;
- (2) On any frequency removed from the center of the authorized bandwidth by a displacement frequency (f_d in kHz) of more than 10 kHz, but not more than 250 percent of the authorized bandwidth: At least $29 \log (f_d^2 / 11)$ dB or 50 dB, whichever is the lesser attenuation;
- (3) On any frequency removed from the center of the authorized bandwidth by more than 250 percent of the authorized bandwidth: At least $43 + 10 \log (P)$ dB.

(f) **Emission Mask F.** For transmitters operating in the 220–222 MHz frequency band, any emission must be attenuated below the power (P) of the highest emission contained within the authorized bandwidth as follows:

- (1) On any frequency from the center of the authorized bandwidth f_o to the edge of the authorized bandwidth f_e : Zero dB.
- (2) On any frequency removed from the center of the authorized bandwidth by a displacement frequency (f_d in kHz) of more than 2 kHz up to and including 3.75 kHz: $30 + 20(f_d - 2)$ dB or $55 + 10 \log (P)$, or 65 dB, whichever is the lesser attenuation.
- (3) On any frequency beyond 3.75 kHz removed from the center of the authorized bandwidth f_d : At least $55 + 10 \log (P)$ dB.

Results

The Out of band emission was performed on the conducted test sample.

As originally tested, the EUT was found to be compliant to the requirements of the test standard(s).

Table 4: Spectral Mask Requirements – Test Results

Test Conditions: Conducted Measurement, Normal Temperature and Voltage only				
Antenna Type: External			Power Setting: See test plan	
Max. Antenna Gain: 5 dBi Mobile 14.1 dBi Base station			Signal State: Modulated	
Ambient Temp.: 21 °C			Relative Humidity: 39%	
Emission Mask				
Operating Freq. MHz	Mode	Limit (dBm)	Measured Value (dBm)	Result
217.5	GMSK 9600	Mask C 90.210(b)/80.211(f) or 90.210(f) Mask J RSS 119	See plots #39 & 40	Pass
217.5	16 QPSK	Mask C 90.210(b)/80.211(f) or 90.210(f) Mask J RSS 119	See plots #41 & 42	Pass
217.5	32 QPSK	Mask C 90.210(b)/80.211(f) or 90.210(f) Mask J RSS 119	See plot #43	Pass
218.5	GMSK 9600	Mask C 90.210(b)/80.211(f) or 90.210(f)	See plots #44	Pass
218.5	16 QPSK	Mask C 90.210(b)/80.211(f) or 90.210(f)	See plots #45	Pass
218.5	32 QPSK	Mask C 90.210(b)/80.211(f) or 90.210(f)	See plots #46	Pass
220.0125	GMSK 9600	Mask F 90.210(f)/Mask F RSS 119	See plot #47	Pass
220.0125	16 QPSK	Mask F 90.210(f)/Mask F RSS 119	See plot #48	Pass
220.0125	32 QPSK	90.210(f)	See plot# 49	Pass

220.9875	GMSK	MaskF 90.210(f)/Mask F RSS 119	See plot #50	Pass
220.9875	GMSK 9600	MaskF 90.210(f)/Mask F RSS 119	See plot #51	Pass
220.9875	32QPSK	MaskF 90.210(f)/Mask F RSS 119	See plot #52	Pass

Note1: All mask measurements were performed as indicated in the above table. Only worst case/ limited number of plots are placed in the report.

Note2: Emission mask CFR part 80.211(f) is applicable for 216 to 220MHz, since the TransAir PTC-3000 does not use audio filter the closet mask Emission mask C was applied.

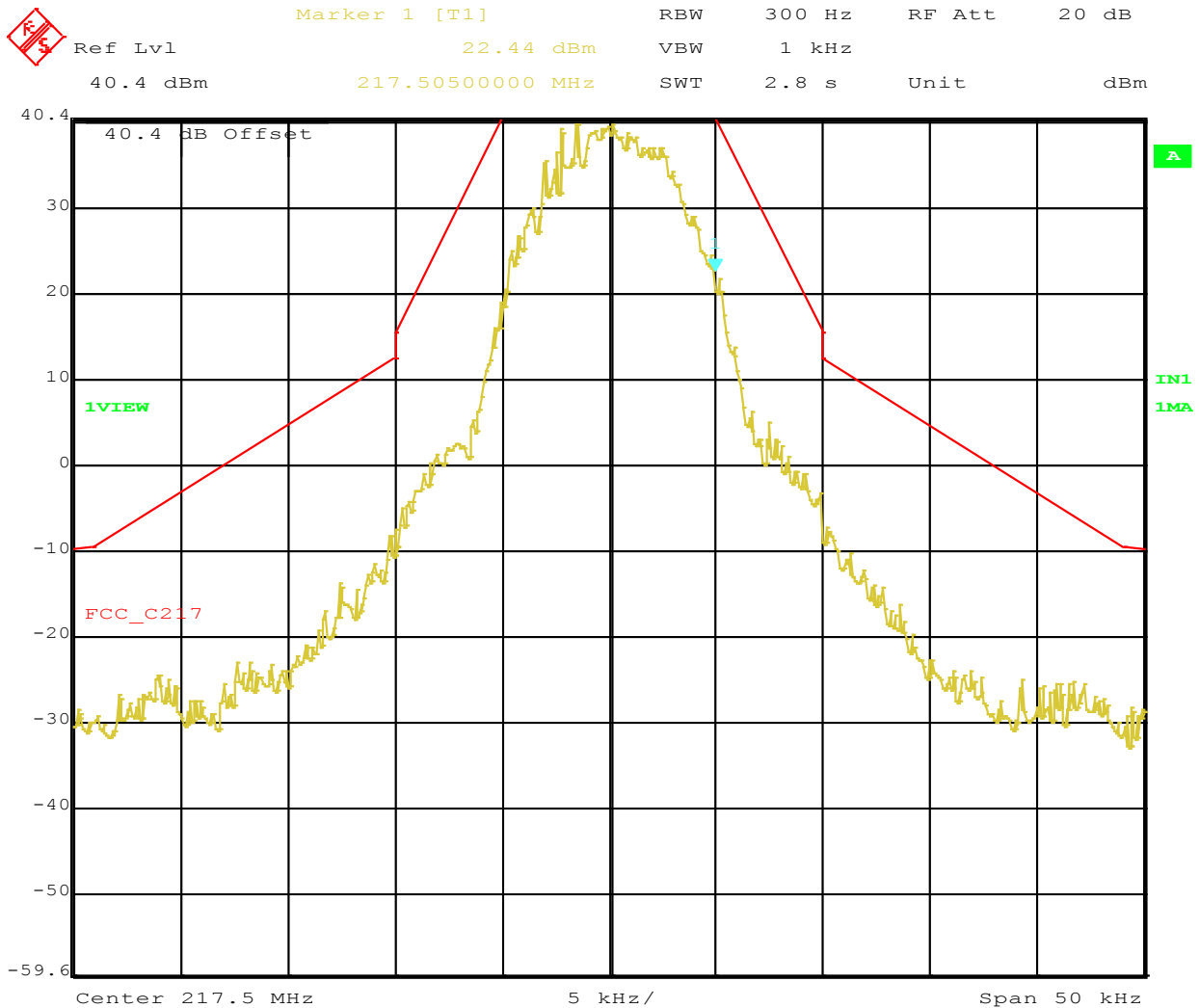

Date: 17.MAY.2012 18:54:22

Figure 39: Emission mask C requirement at Operating Channel 217.5 MHz, GMSK

Note: Reference level of spectrum analyzer coincides with highest power level of the EUT. See the CW power and modulated signal captured in Figure #52

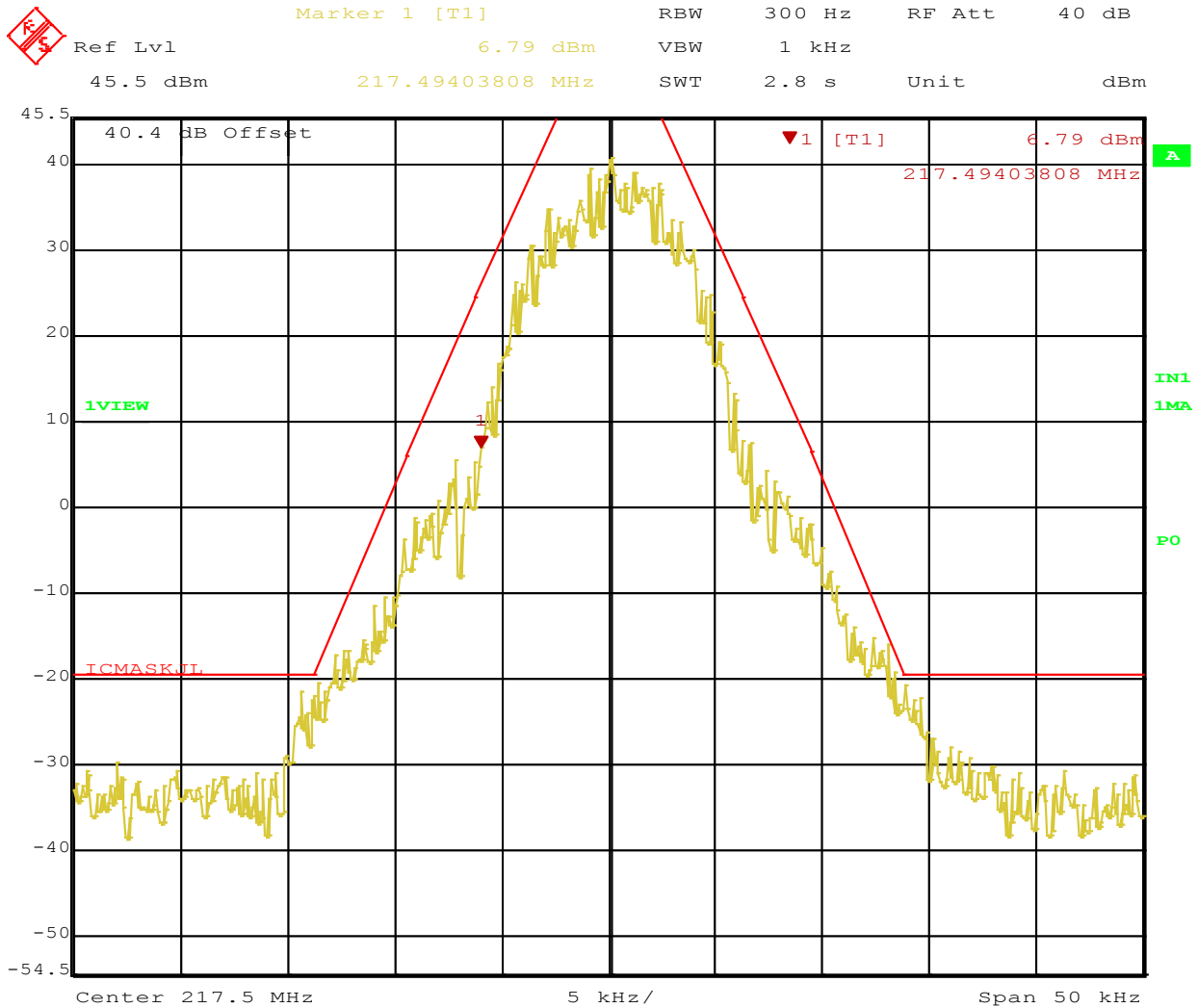

Title: Mask 217.5 GMSK9600 Powersetting full power
 Date: 29.FEB.2012 13:57:35

Note: Reference level adjusted measured power level

Figure 40: Emission mask J Requirement at Operating Channel 217.5 MHz, GMSK

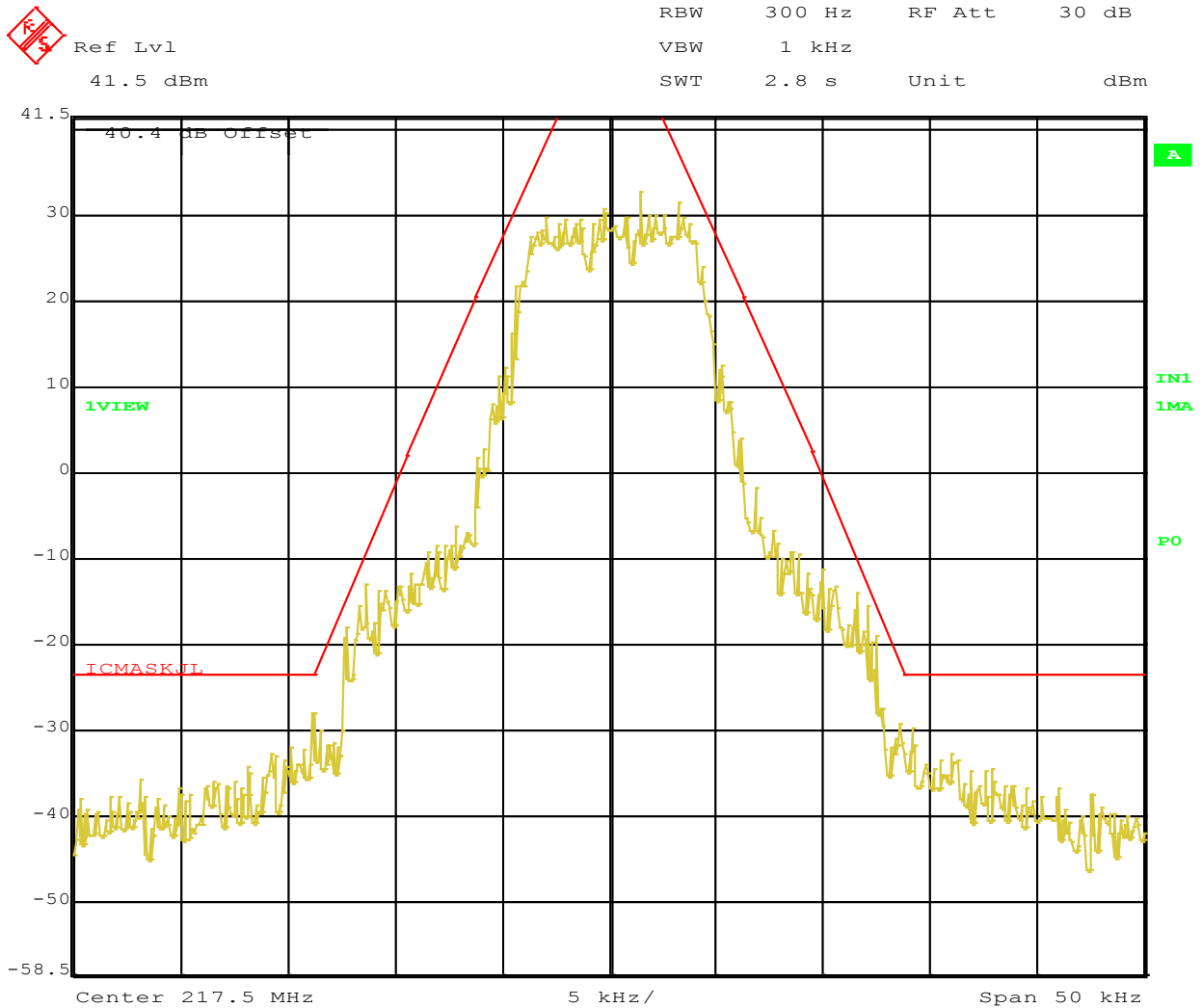

Title: QPSK 16K Power setting Att 7
 Date: 29.FEB.2012 13:36:24

Figure 41: Emission mask J Requirement at Operating Channel 217.5 MHz, 16 QPSK

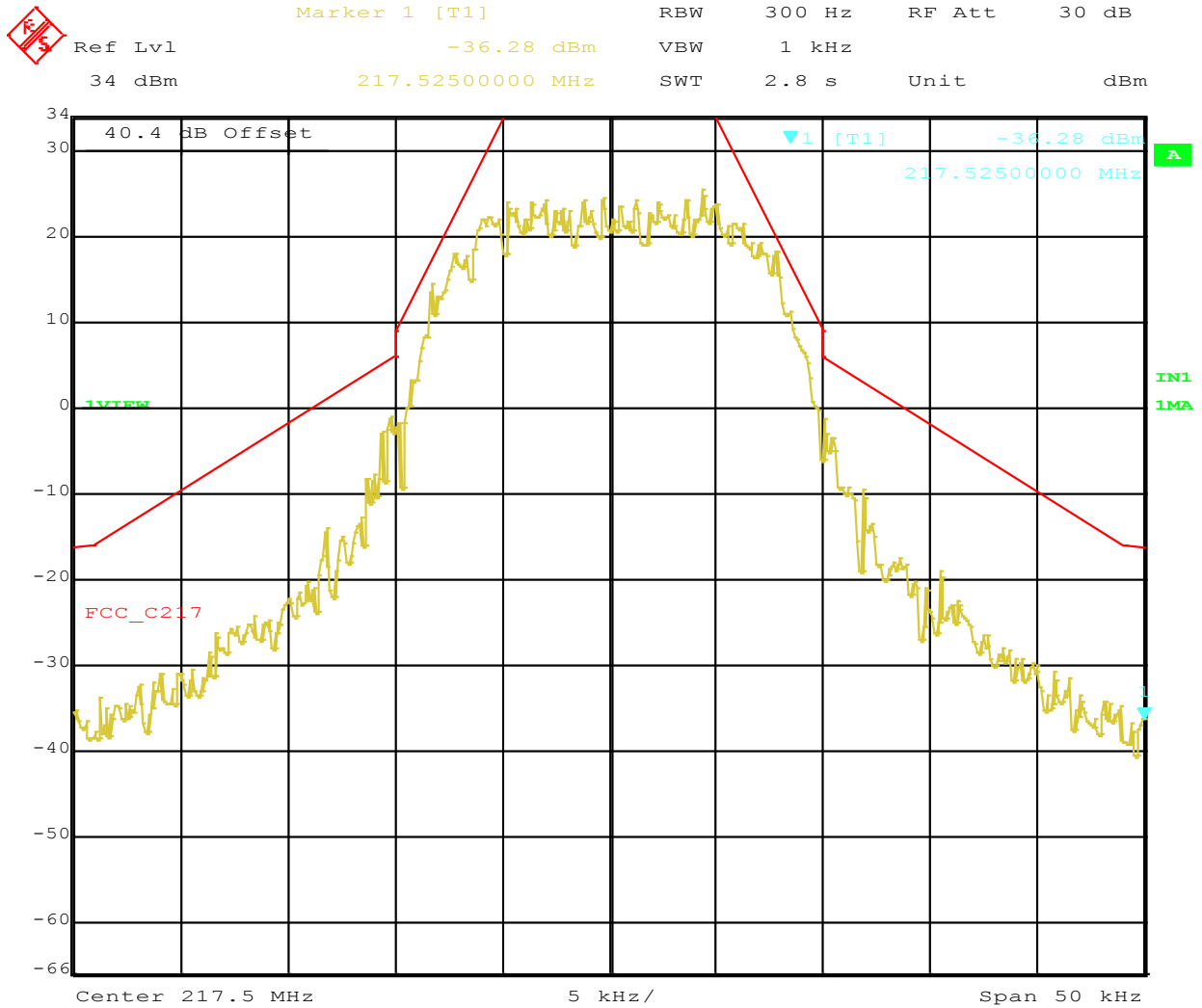

Date: 24.APR.2012 15:07:44

Figure 42: Emission mask C Requirement at Operating Channel 217.5 MHz, 32 QPSK

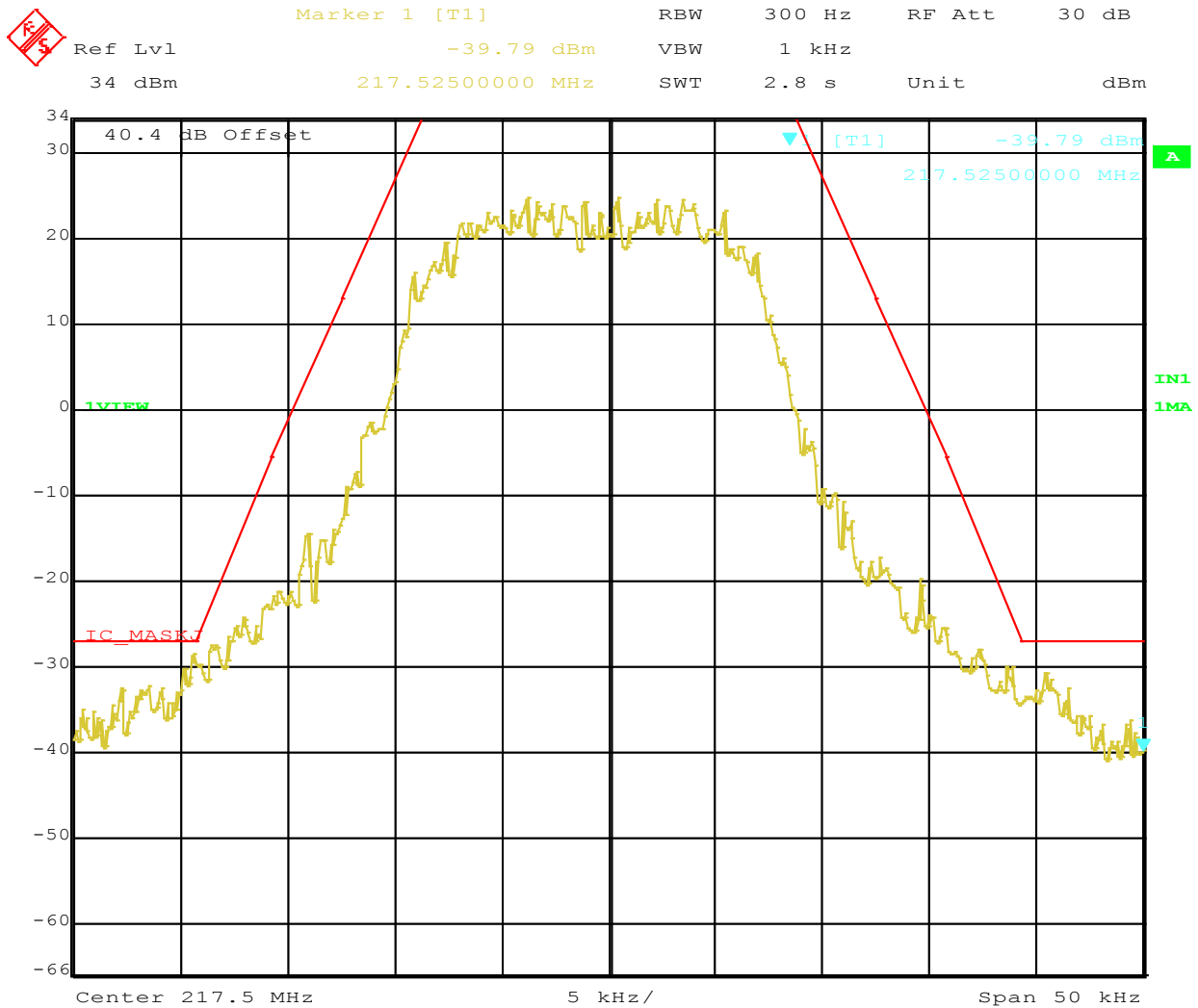

Date: 24.APR.2012 14:21:31

Figure 43: Emission mask J Requirement at Operating Channel 217.5 MHz, 32 QPSK

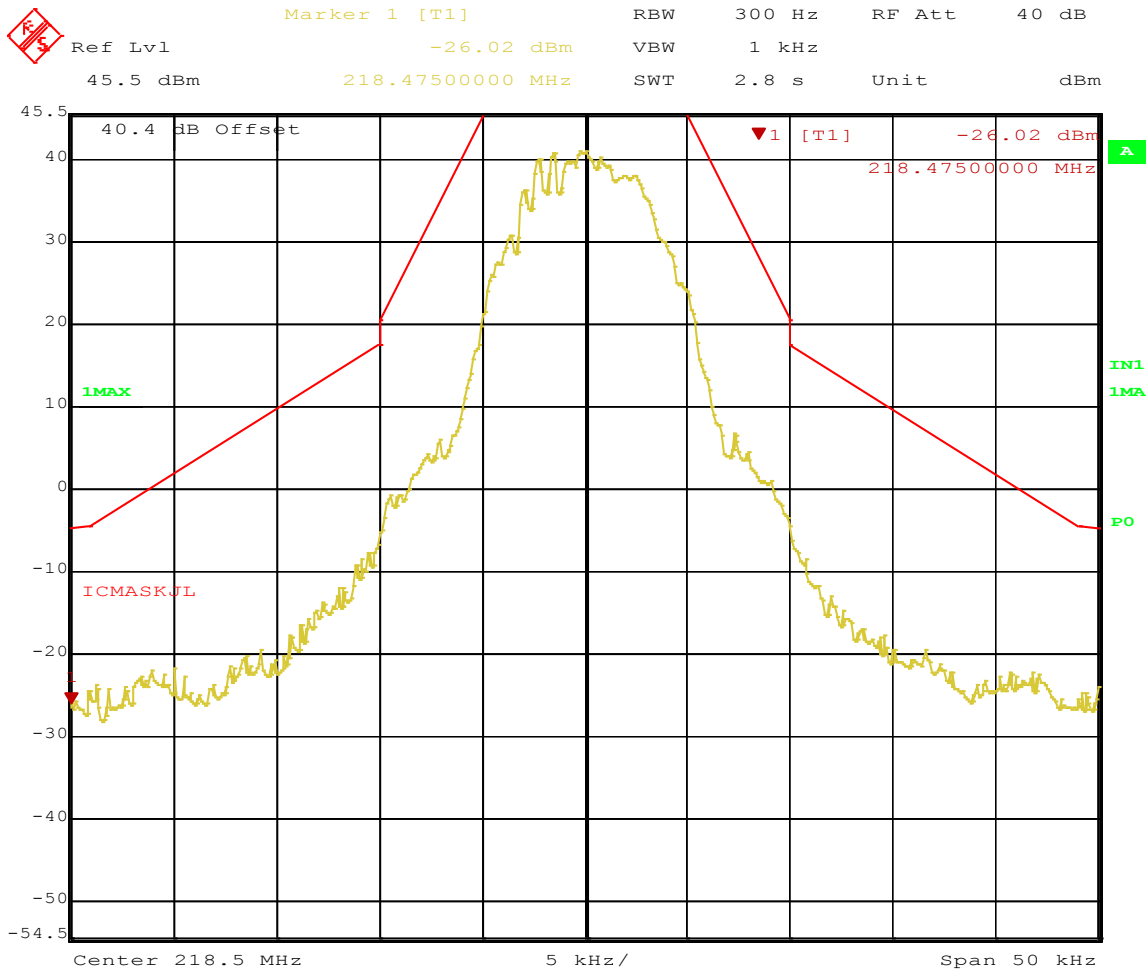

Title: Mask 218.5 GMSK9600 Powersetting full power
 Date: 29.FEB.2012 15:48:44

Figure 44: Emission mask C Requirement at Operating Channel 218.5 MHz, GMSK

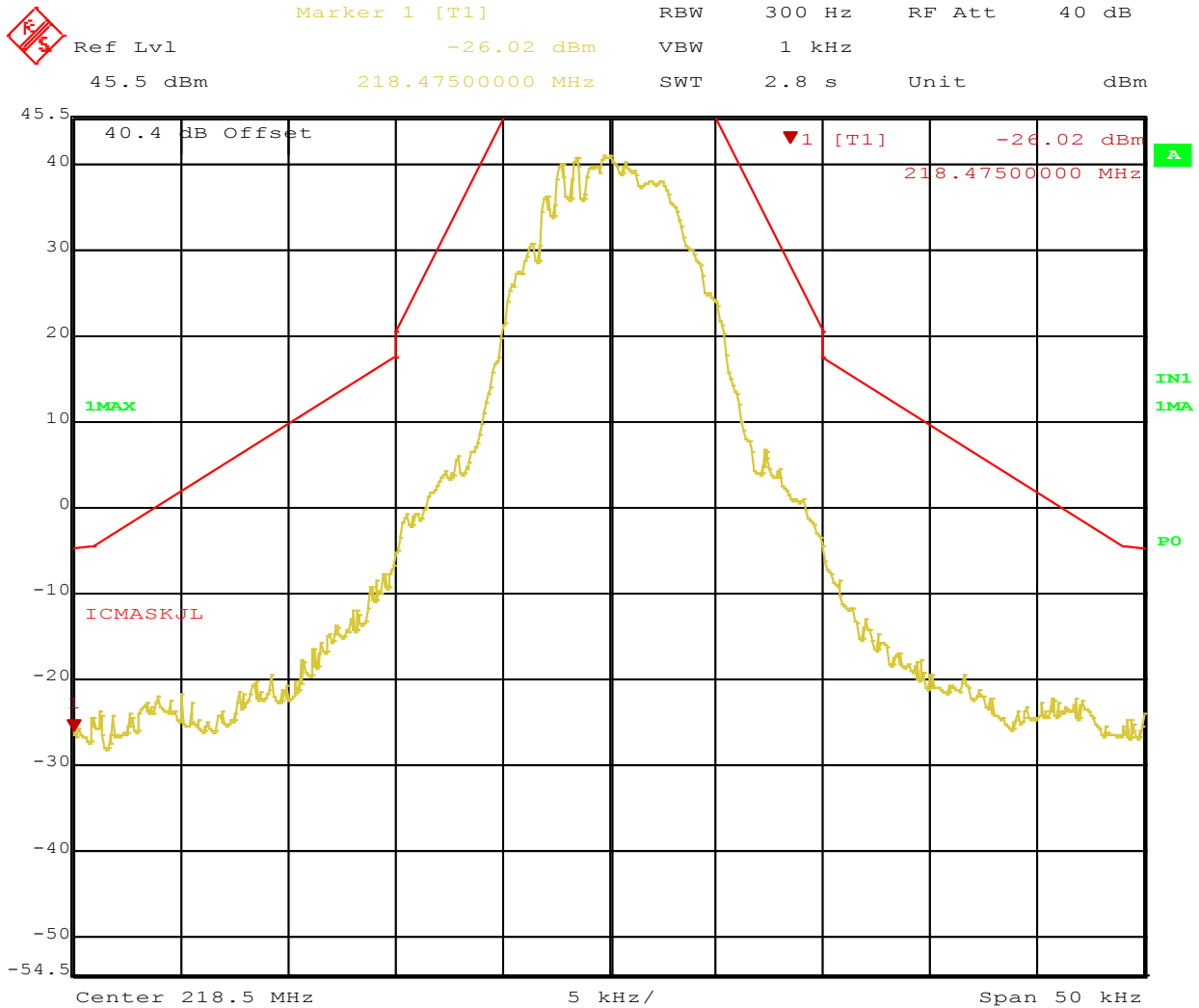

Title: Mask 218.5 GMSK9600 Powersetting full power
 Date: 29.FEB.2012 15:48:44

Figure 45: Emission mask C Requirement at Operating Channel 218.5 MHz, 16 QPSK

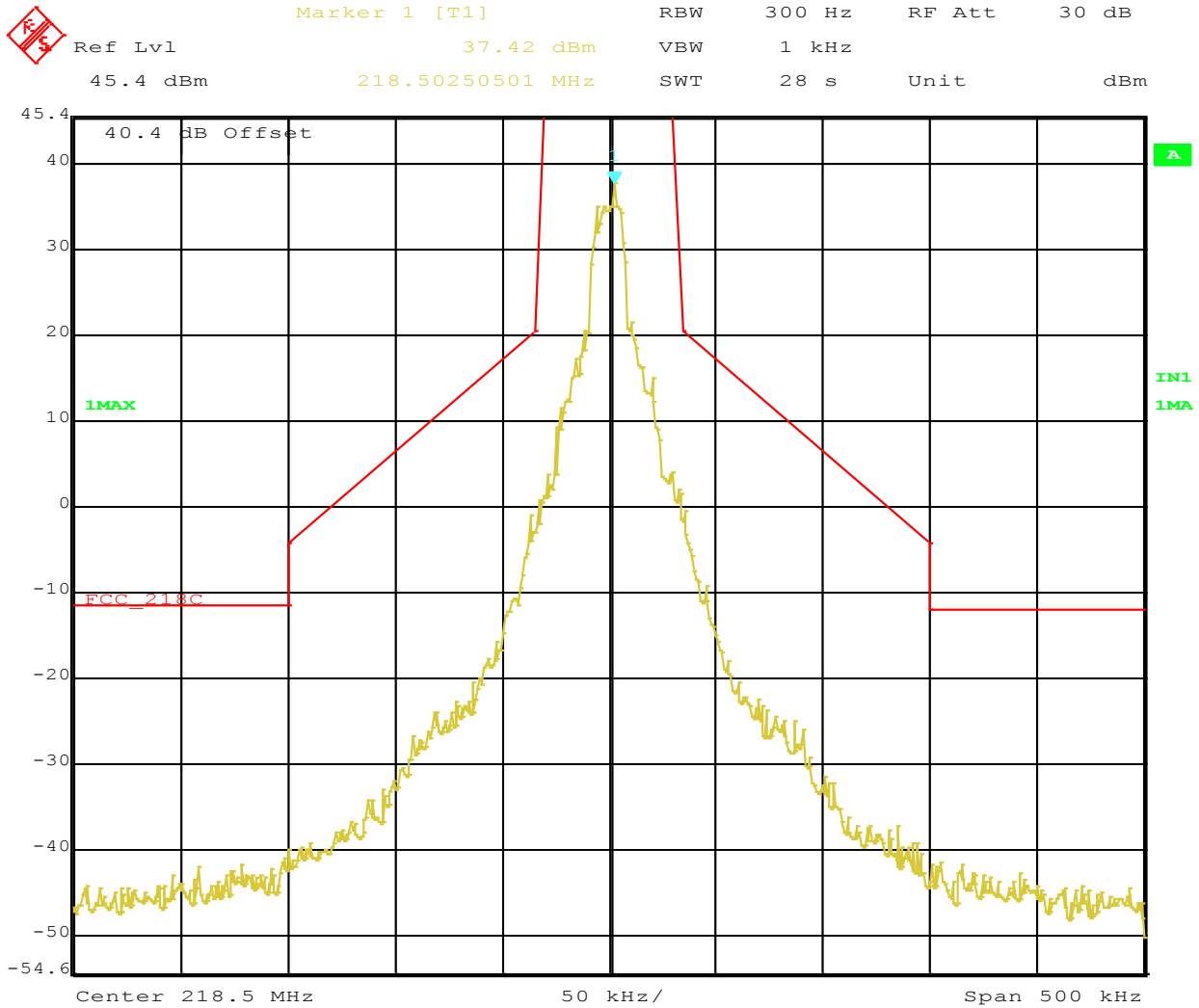

Date: 18.MAY.2012 14:06:08

Figure 46: Emission mask C Requirement at Operating Channel 218.5 MHz, 32 QPSK

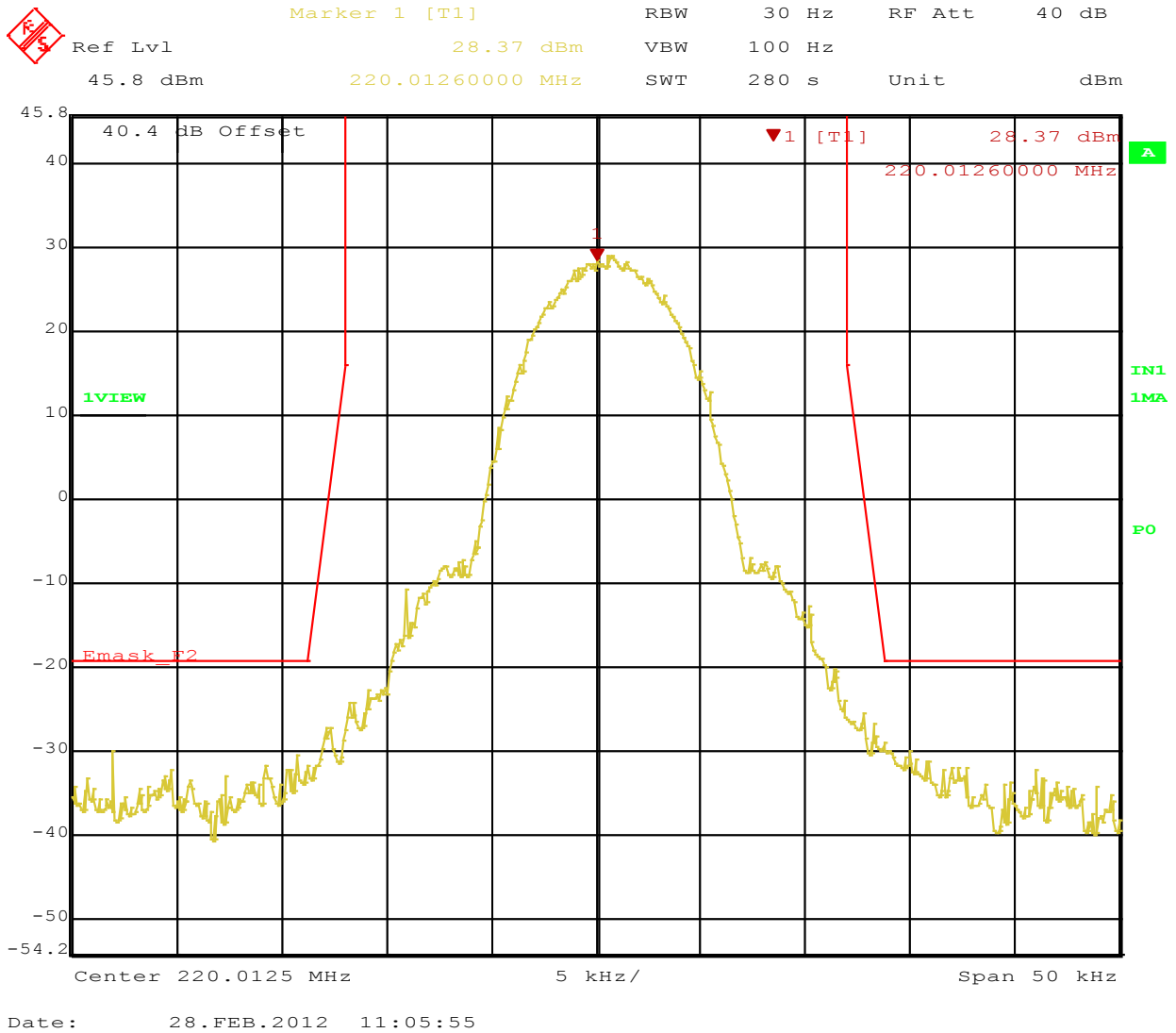

Figure 47: Emission mask F Requirement at Operating Channel 220.0125 MHz, GMSK

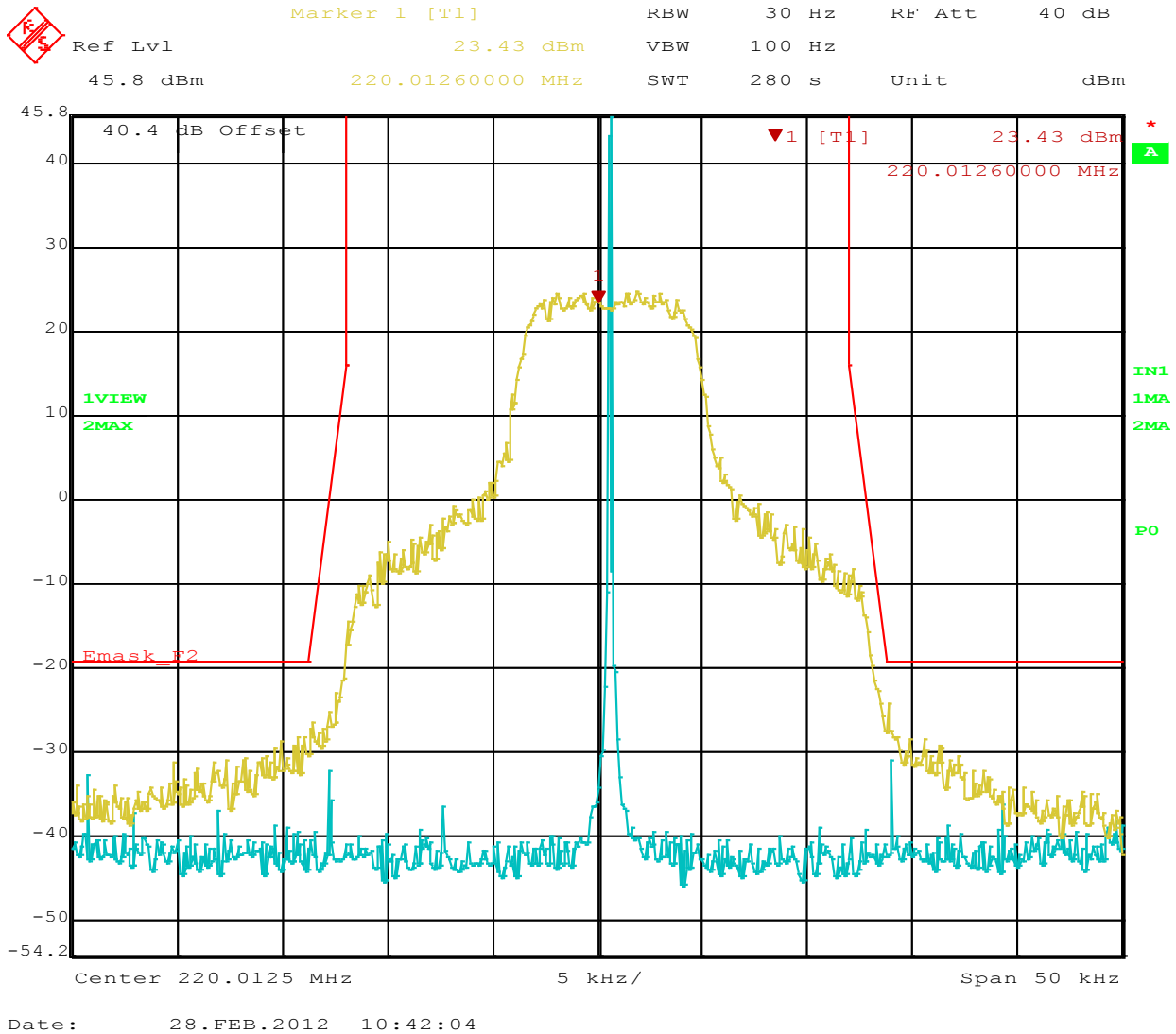
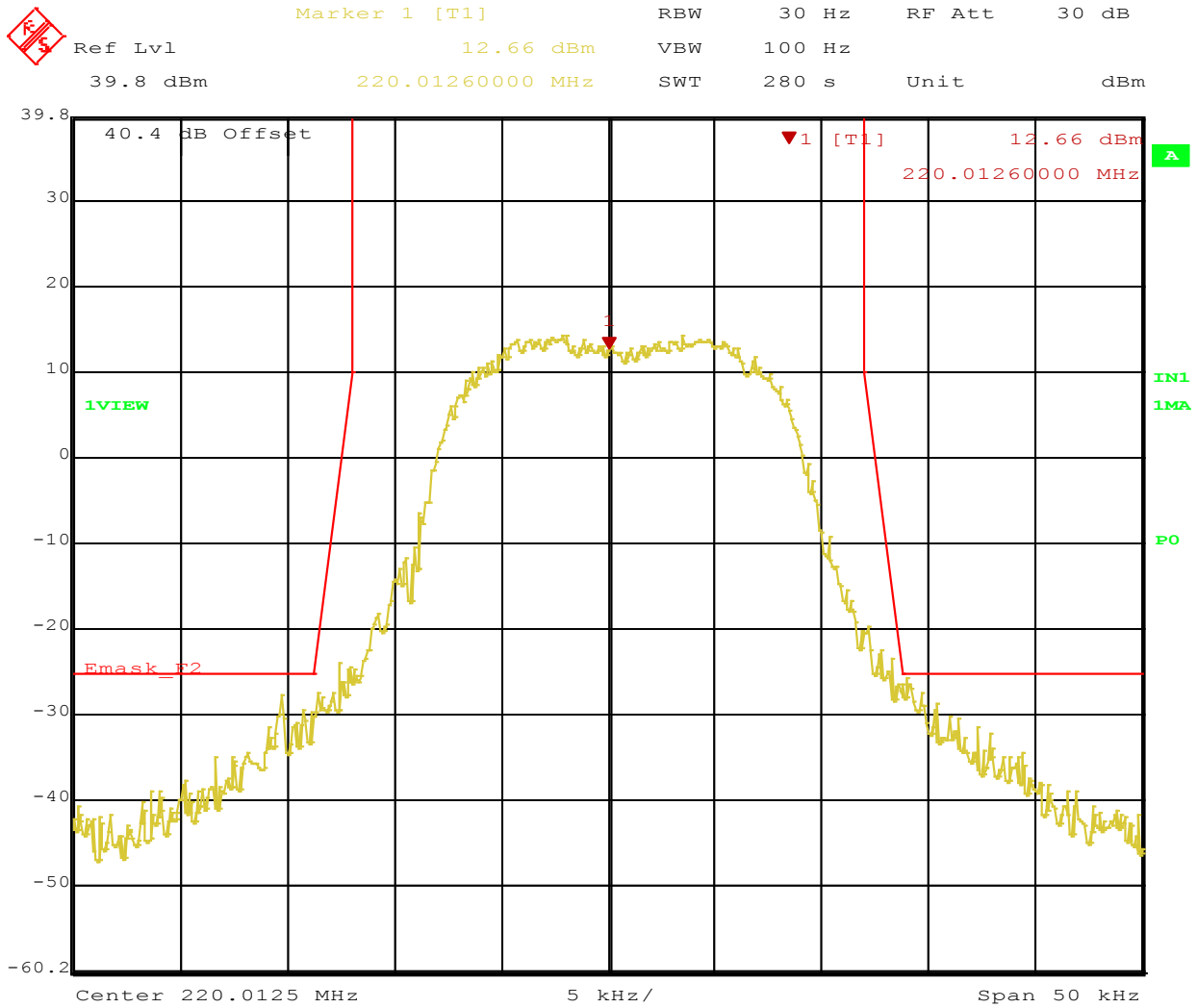
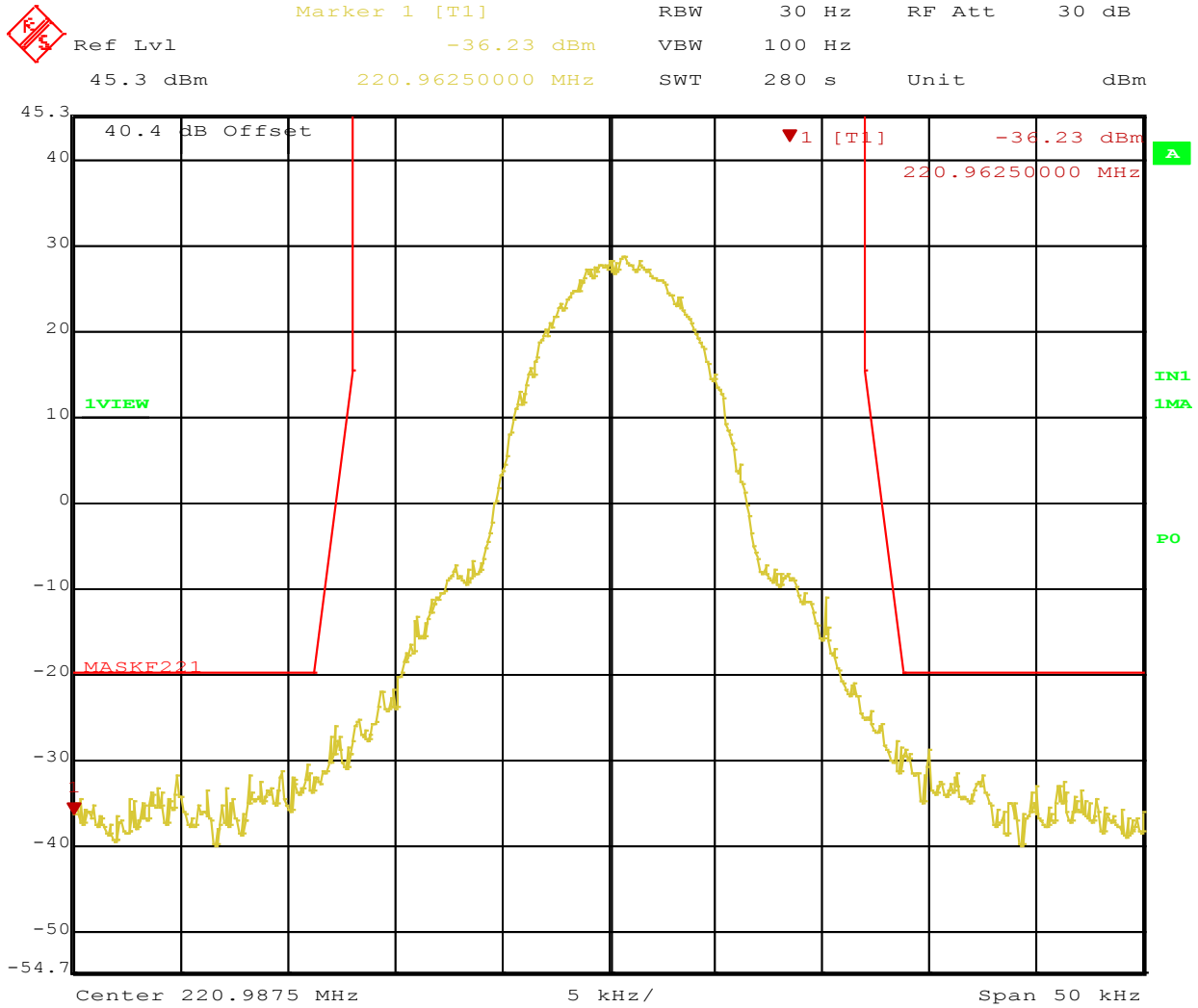

Figure 48: Emission mask F Requirement at Operating Channel 220.0125 MHz, 16QPSK



Date: 28.FEB.2012 11:21:17

Figure 49: Emission mask F Requirement at Operating Channel 220.0125 MHz, 32 QPSK



Title: GMSK 9600bps High channel Full power
 Date: 28.FEB.2012 14:01:09

Figure 50: Emission mask F Requirement at Operating Channel 220.9875 MHz, GMSK

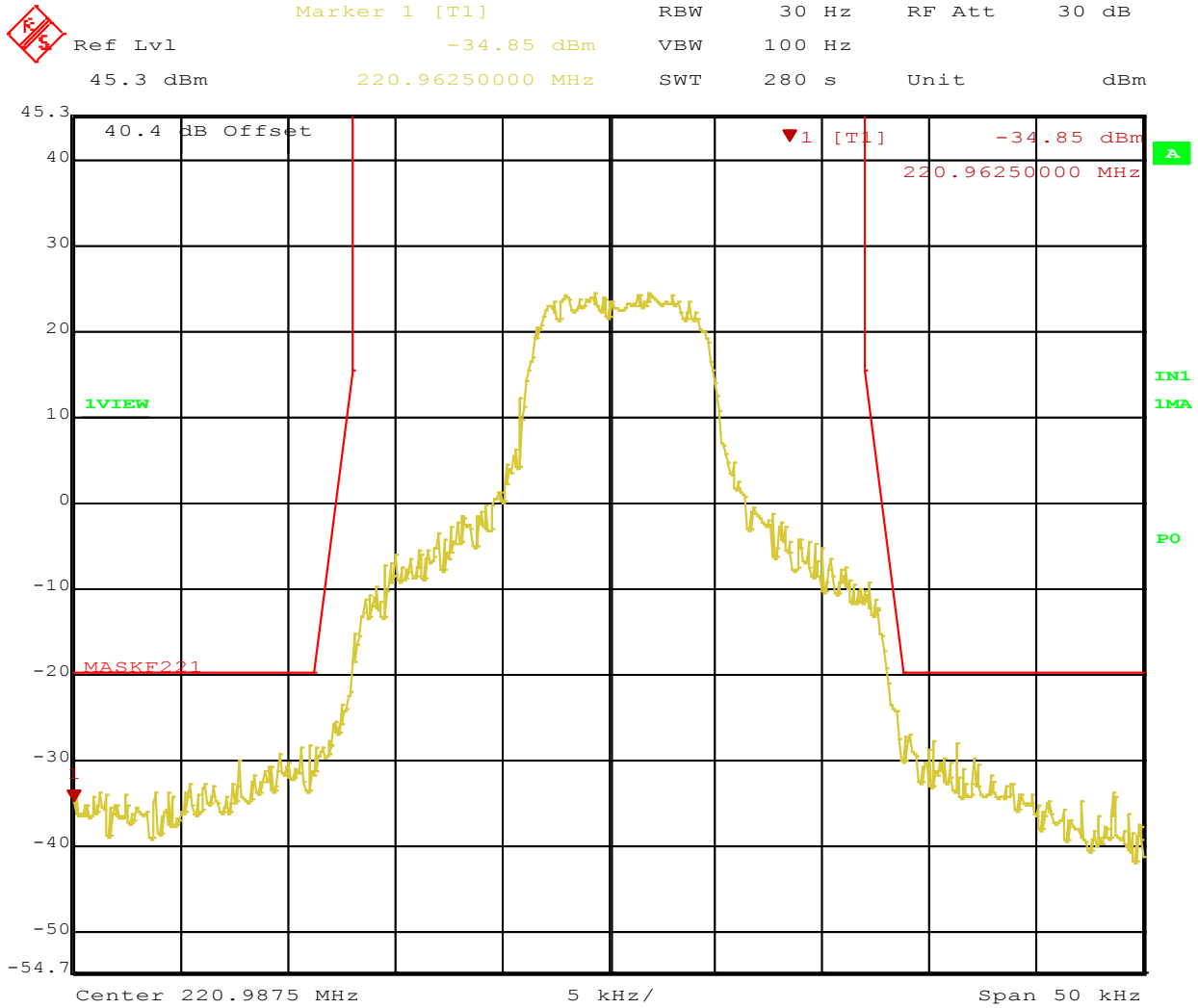

Title: QPSK mid Channel Pset -2
 Date: 28.FEB.2012 13:49:25

Figure 51: Emission mask F Requirement at Operating Channel 220.9875 MHz, 16 QPSK

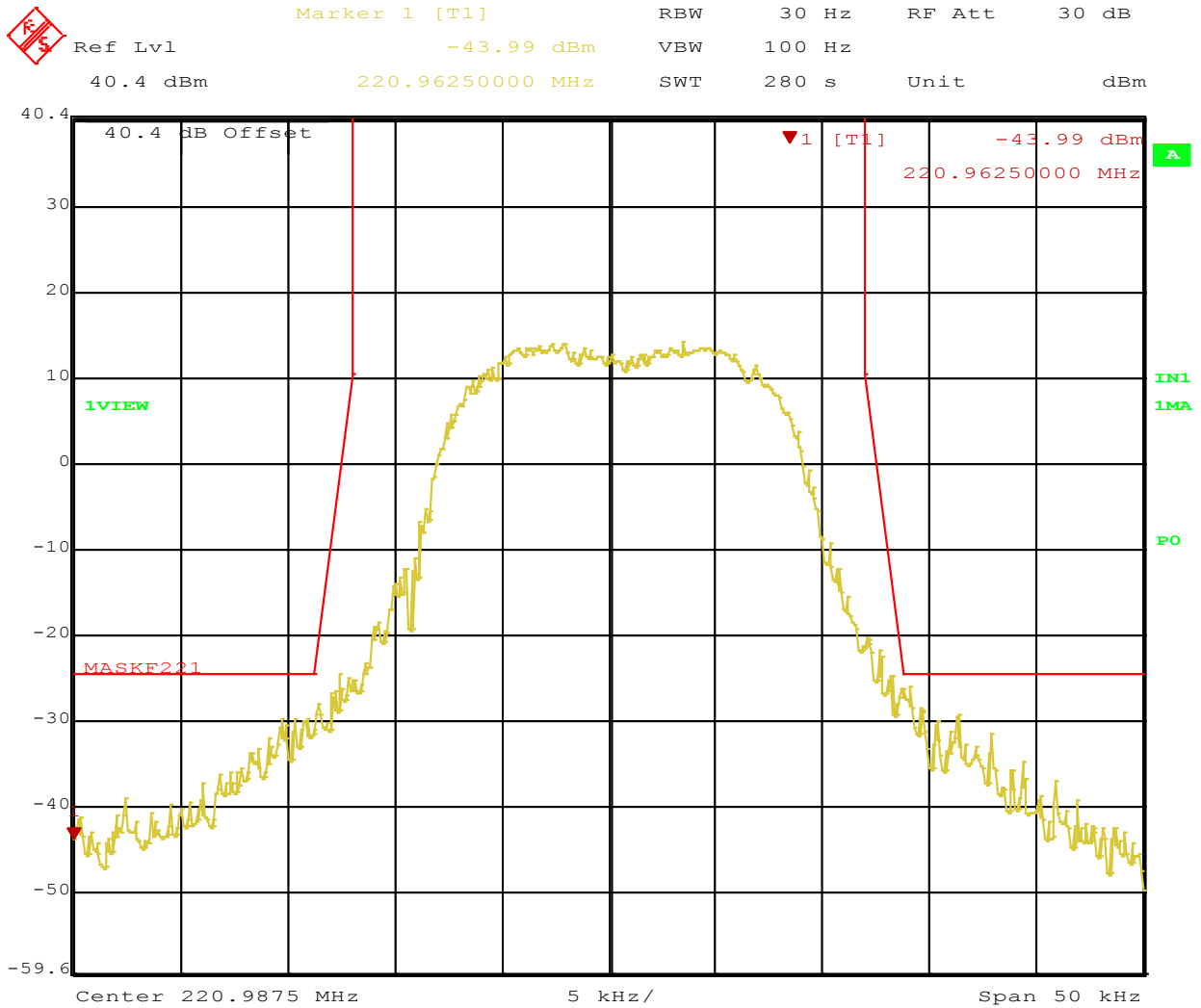

Figure 52: Emission mask F Requirement at Operating Channel 220.9875 MHz, 32 QPSK

4.4 Conducted Spurious Emissions

Requirements is same as Emission Mask F as para 4.3 of this report. Any frequency outside the band of 216 MHz to 222 MHz, the power output level must be below -25 dBm

4.4.1 Test Method

The conducted method was used to measure the channel power output per ANSI/TIA-603-C:2004

The measurements were performed 30 MHz to 2.3GHz. Preliminary measurements indicated worst case emissions

The worst-case sample result is recorded below.

Test Setup:

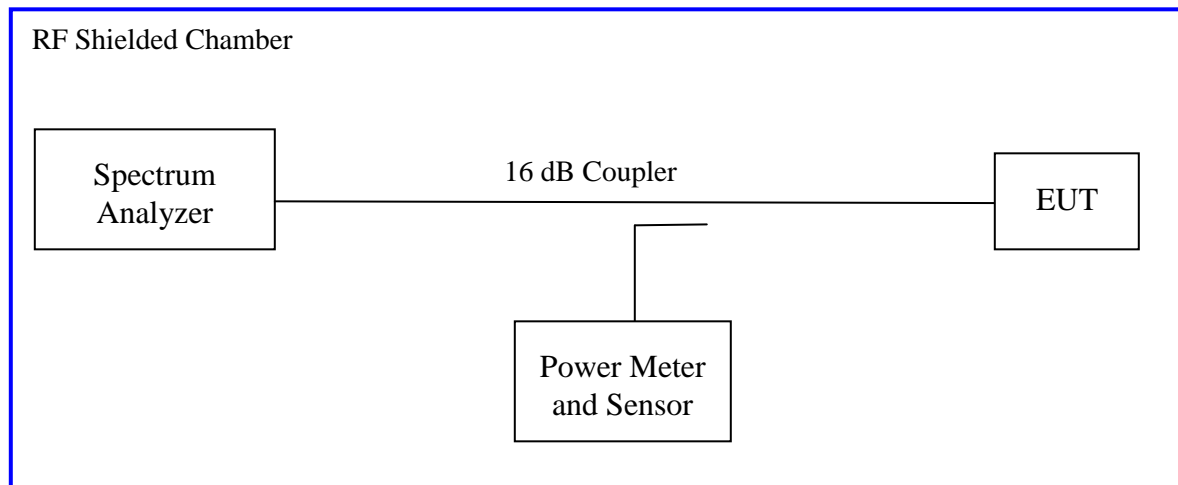

4.4.2 Results

Table 5: Out of band Conducted Emission – Test Results

Operating Freq.	Mode	Result
217.5	GMSK	Pass
	16QPSK	Pass
	32 QPSK	Pass
218.5	GMSK	Pass
	16QPSK	Pass
	32 QPSK	Pass
220.0125	GMSK	Pass
	16QPSK	Pass
	32 QPSK	Pass
220.9875	GMSK	Pass
	16QPSK	Pass
	32 QPSK	Pass
222.00	GMSK	Pass
	16QPSK	Pass
	32 QPSK	Pass
217.500	Receive	Pass
220.9875	Receive	Pass

Note1: RSS-119 limits operation to 217-218 and 219-222 MHz.

Note2: Emission mask C is applicable for frequency band 216 to 220MHz which give -13dBm as limit for out of band emissions but the worst case limit of Mask F -25dBm is applied for all plots.

Note3: No emissions were observed in 1 to 2.3GHz band in preliminary scan, no final plots were taken with required RBW of 1MHz.

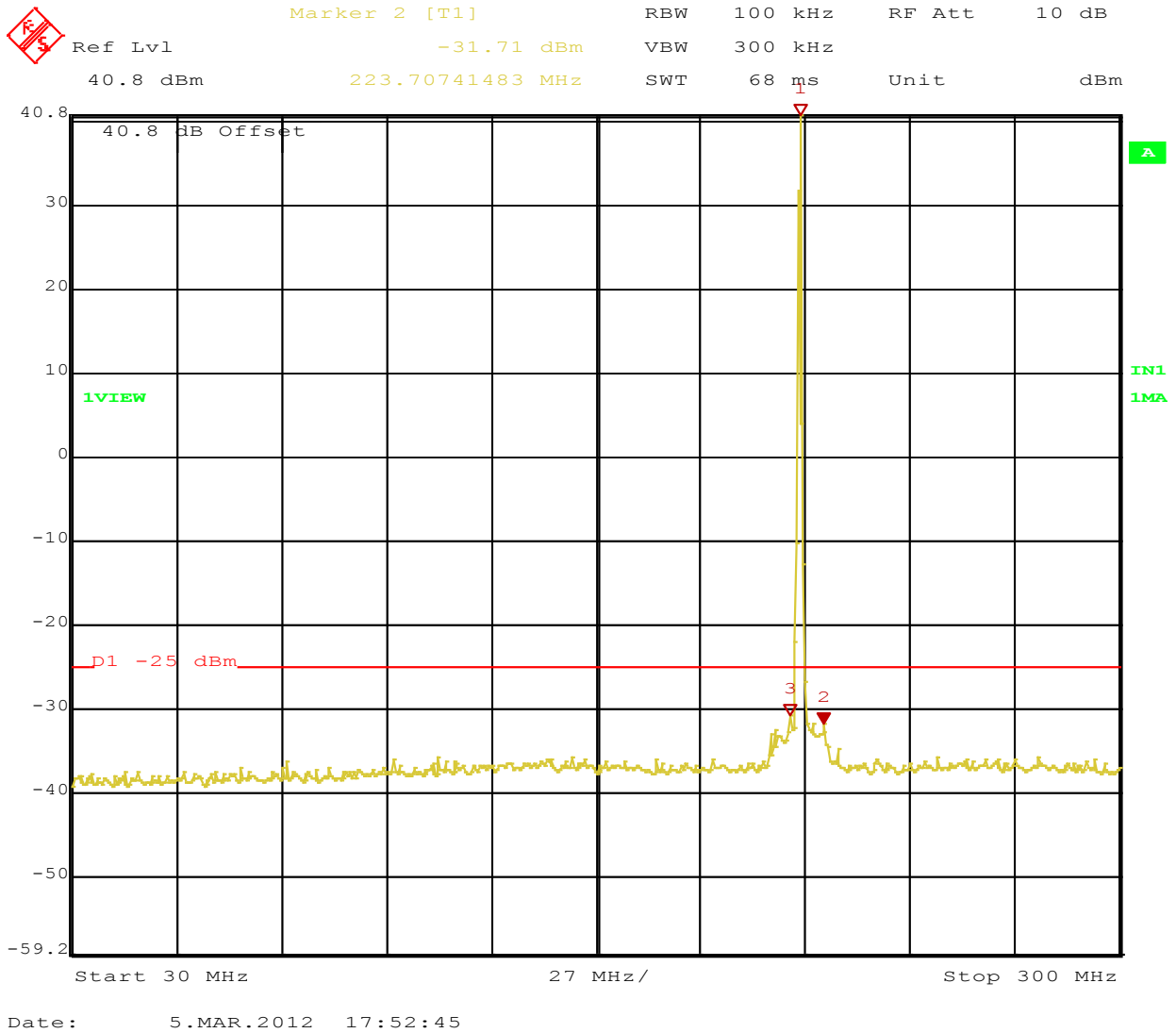
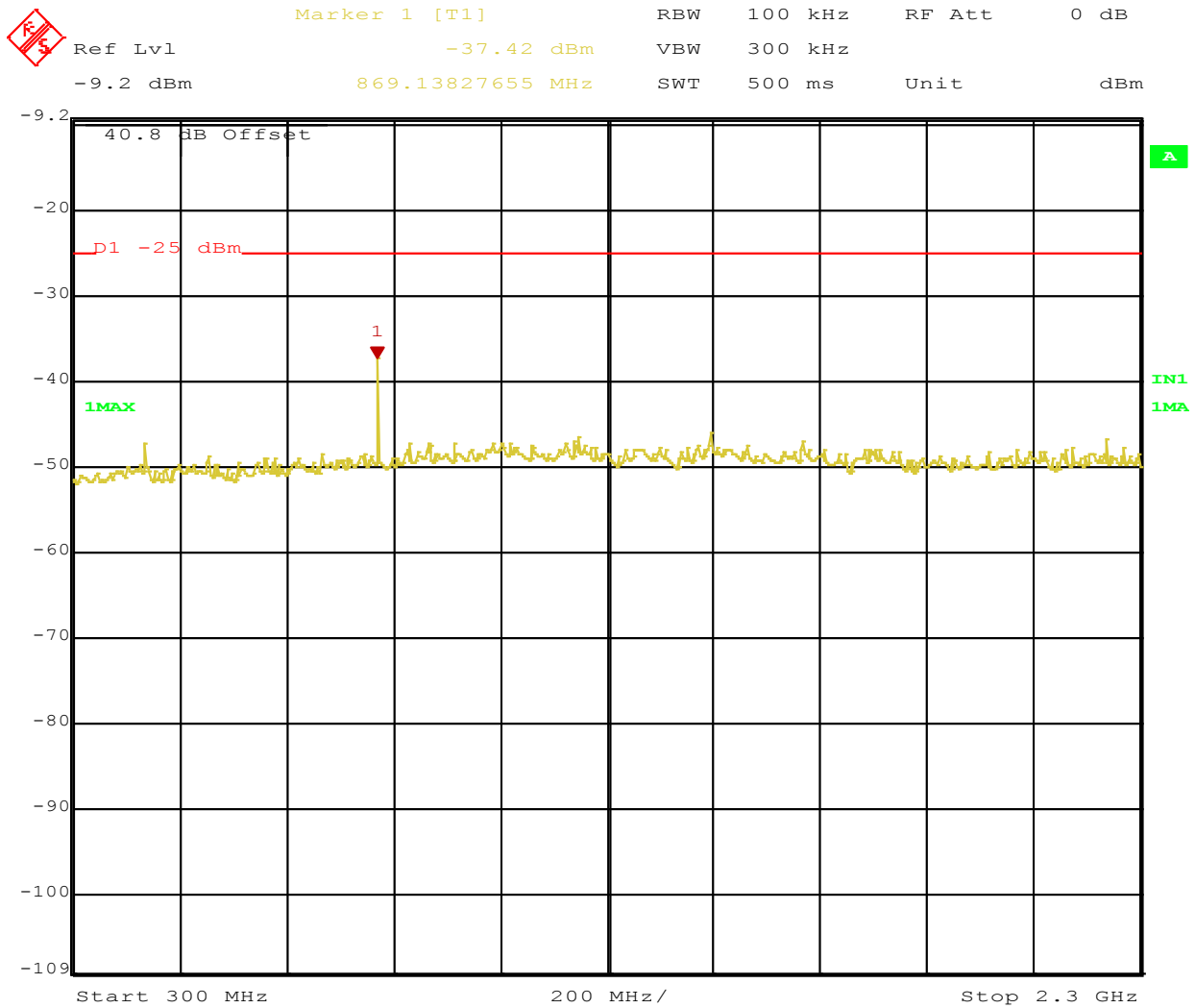

Figure 53: Out of Band Emissions Operating Channel 217.5 MHz, GMSK Plot1



Date: 5.MAR.2012 17:26:29

Figure 54: Out of Band Emissions Operating Channel 217.5 MHz, GMSK Plot 2

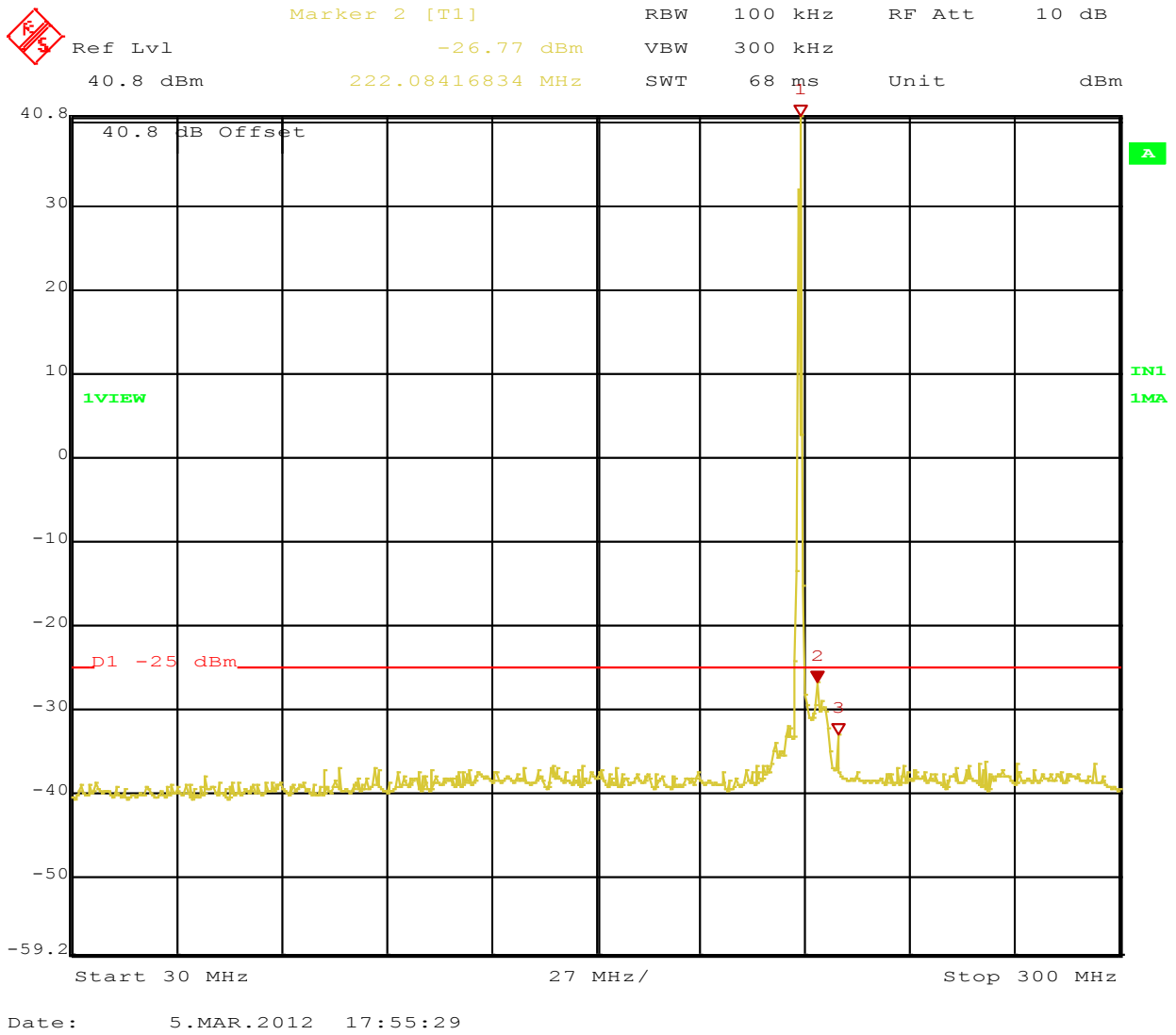
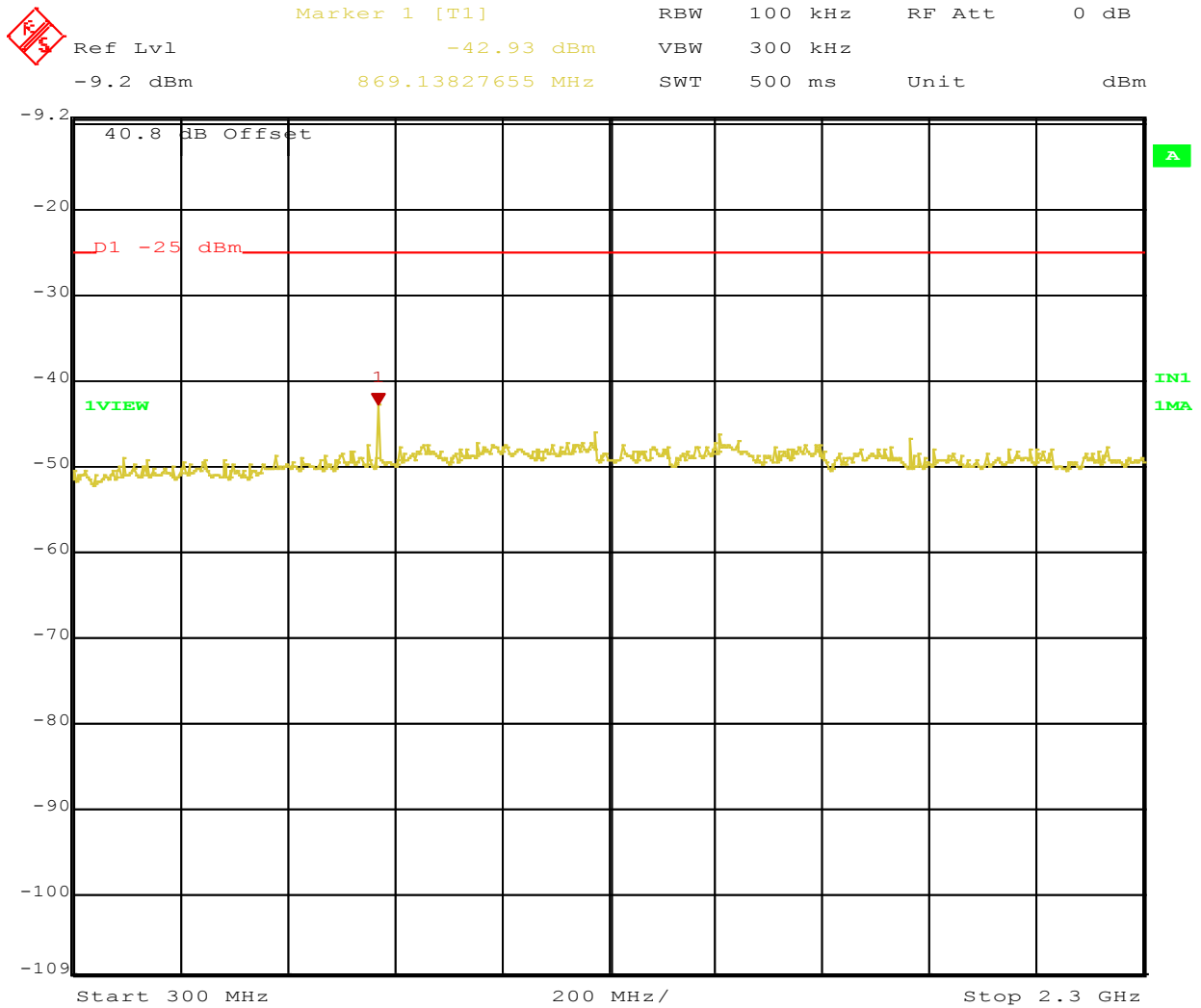

Figure 55: Out of Band Emissions Operating Channel 217.5 MHz, 16QPSK Plot 1



Date: 5.MAR.2012 17:18:49

Figure 56: Out of Band Emissions Operating Channel 217.5 MHz, 16QPSK Plot 2

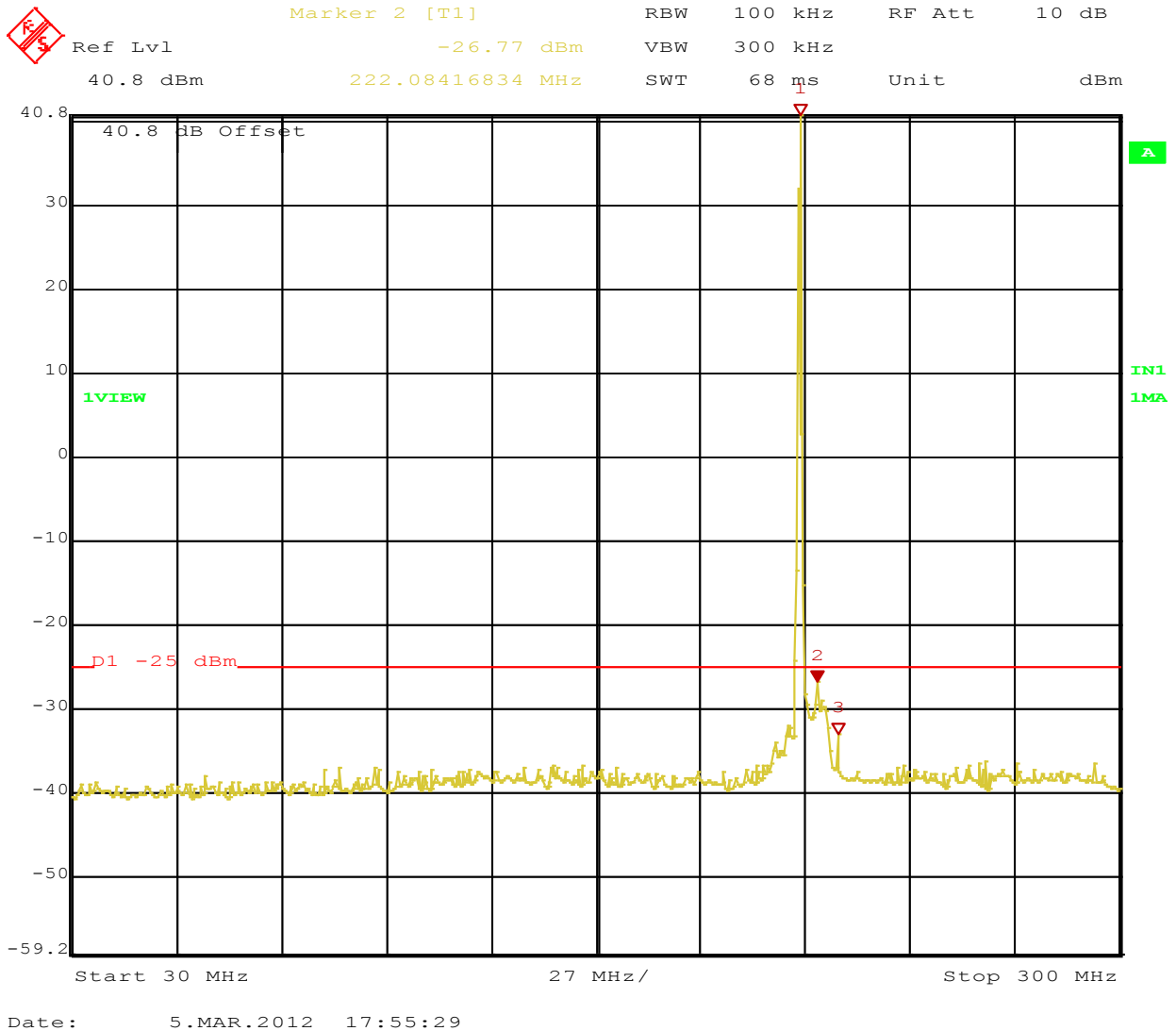
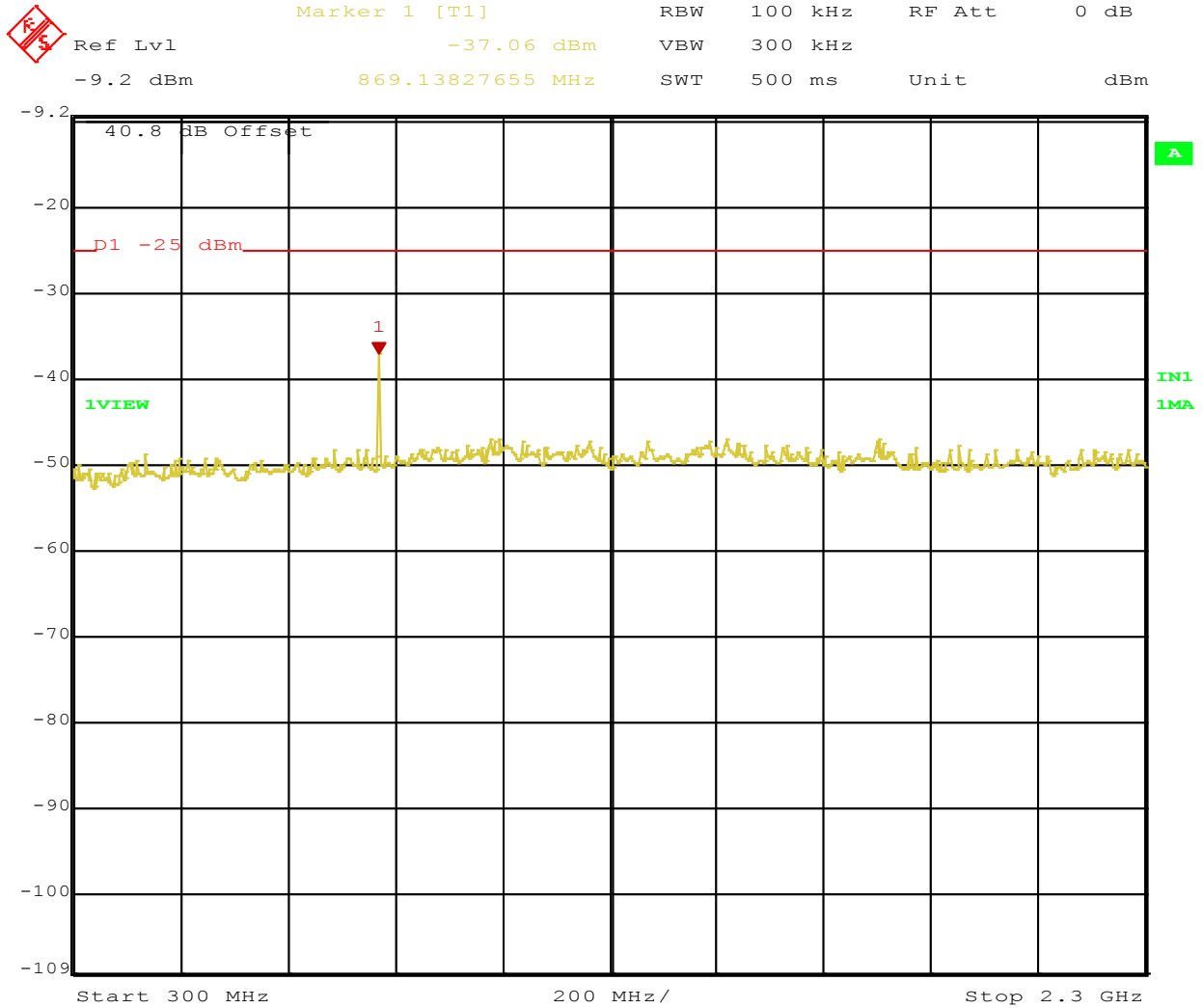

Figure 57: Out of Band Emissions Operating Channel 217.5 MHz, 32 QPSK Plot 1



Date: 5.MAR.2012 17:25:04

Figure 58: Out of Band Emissions Operating Channel 217.5 MHz, 32 QPSK Plot 2

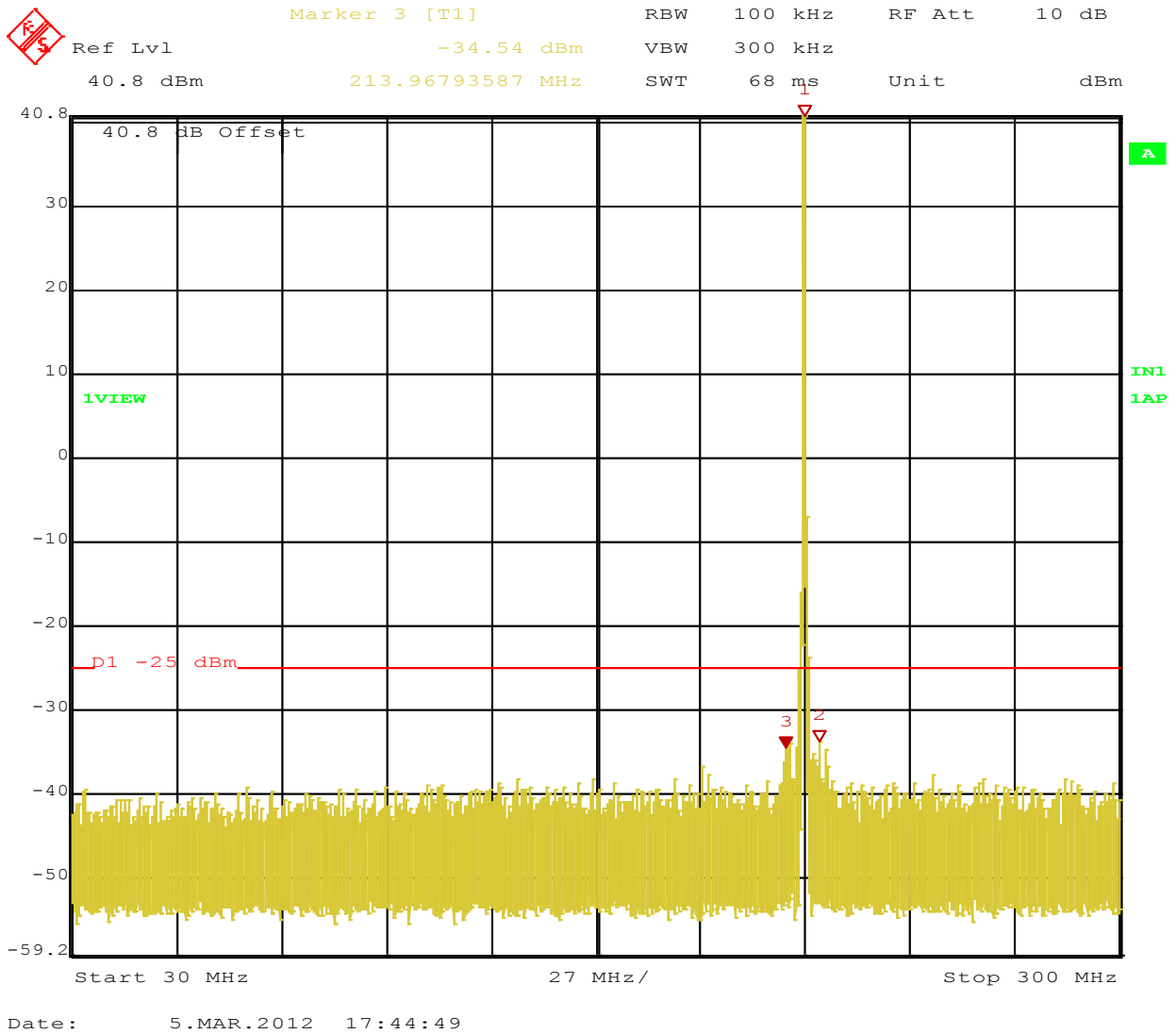

Figure 59: Out of Band Emissions Operating Channel 218.5 MHz, GMSK Plot 1

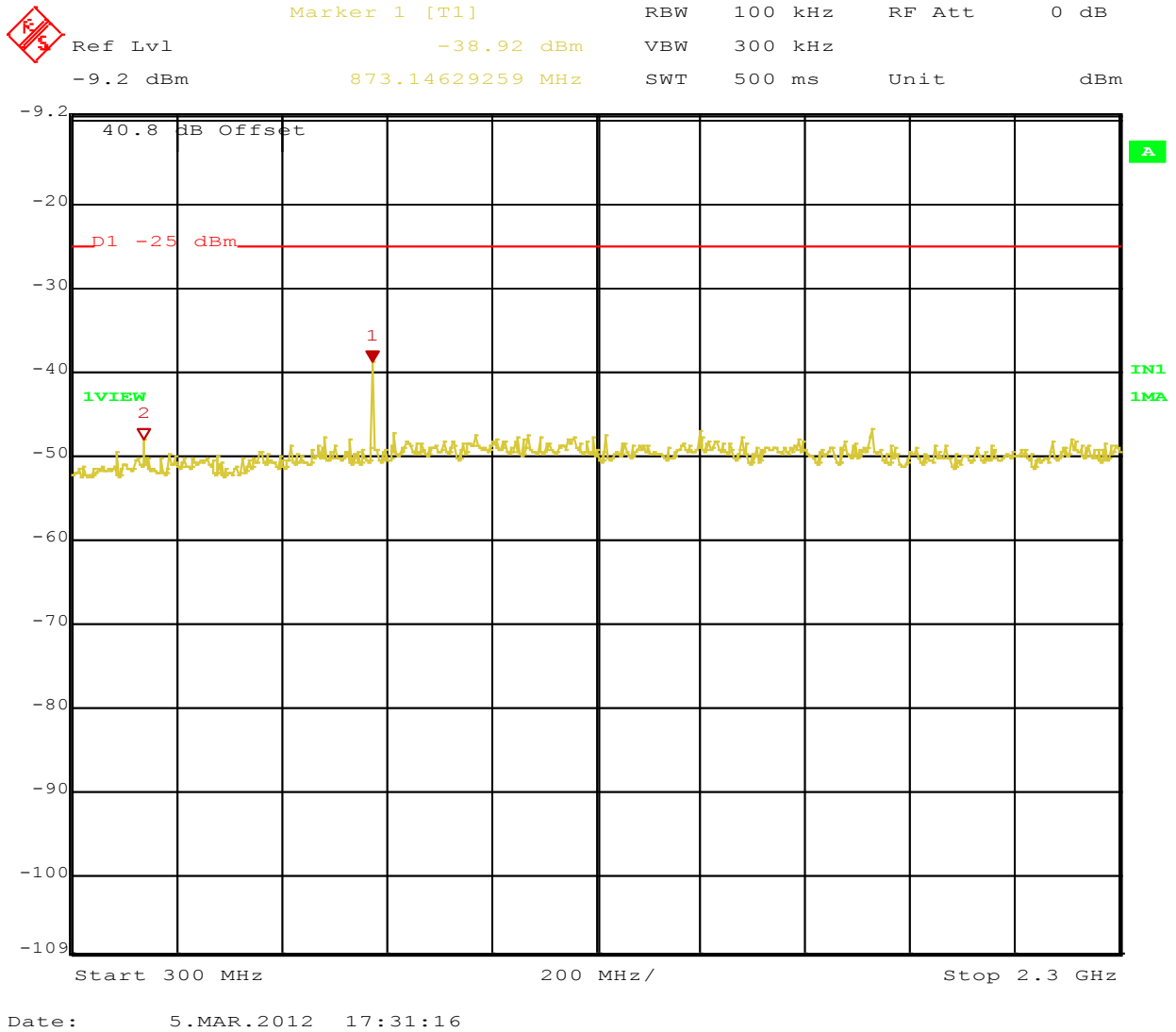

Figure 60: Out of Band Emissions Operating Channel 218.5 MHz, GMSK Plot 2

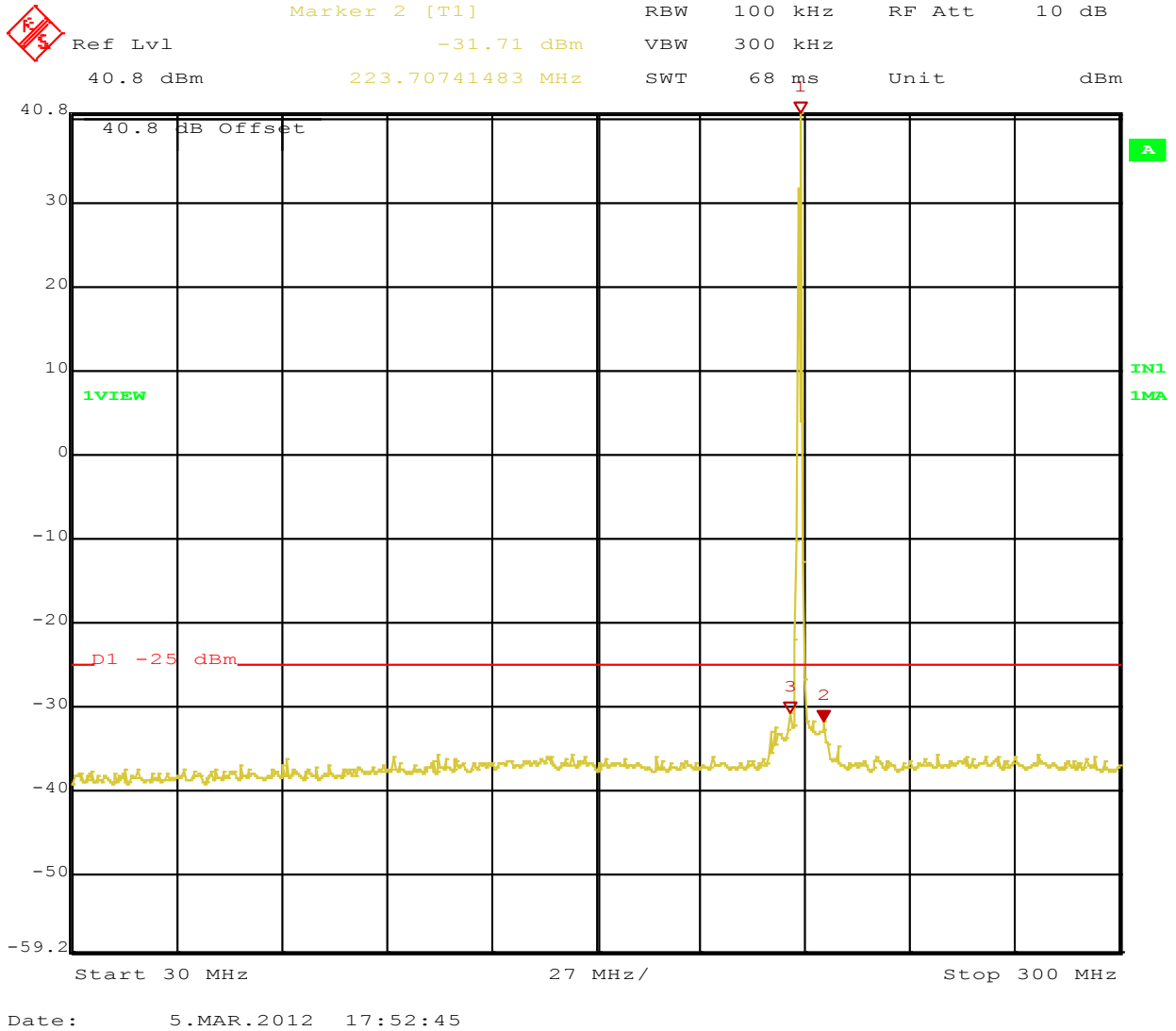
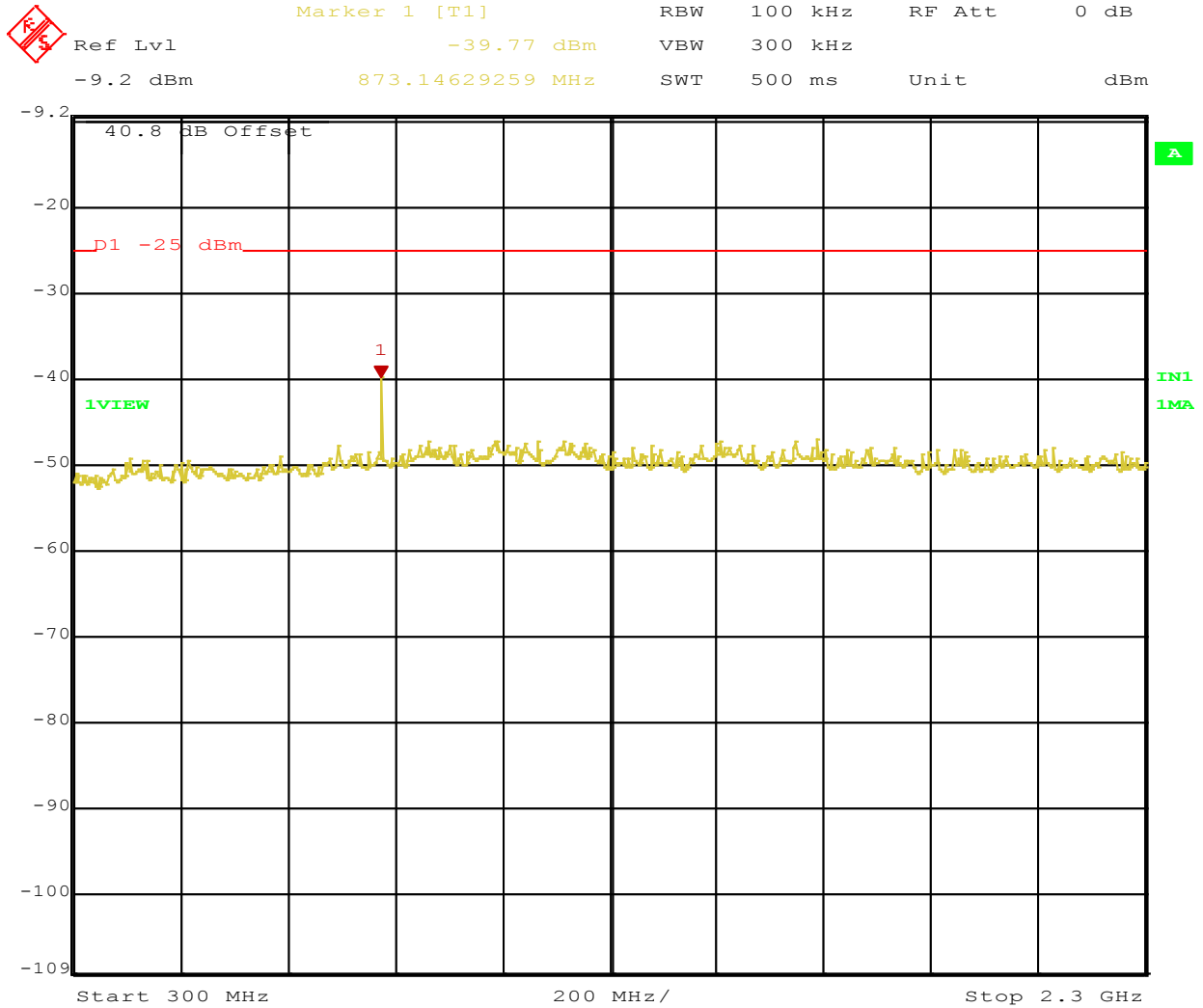

Figure 61: Out of Band Emissions Operating Channel 218.5 MHz, 16 QPSK Plot 1



Date: 5.MAR.2012 17:11:32

Figure 62: Out of Band Emissions Operating Channel 218.5 MHz, 16 QPSK Plot 2

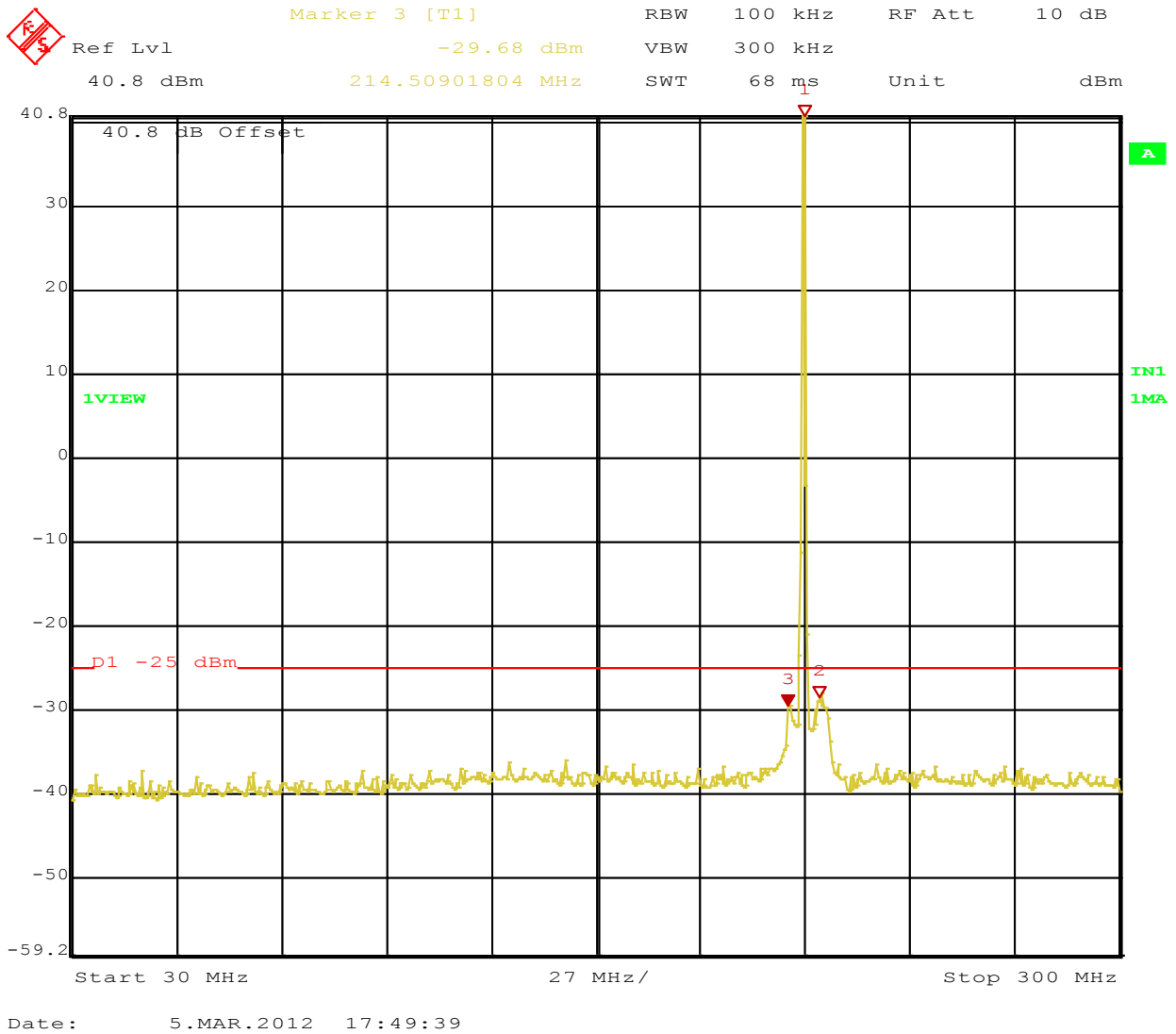

Figure 63: Out of Band Emissions Operating Channel 218.5 MHz, 32 QPSK Plot 1

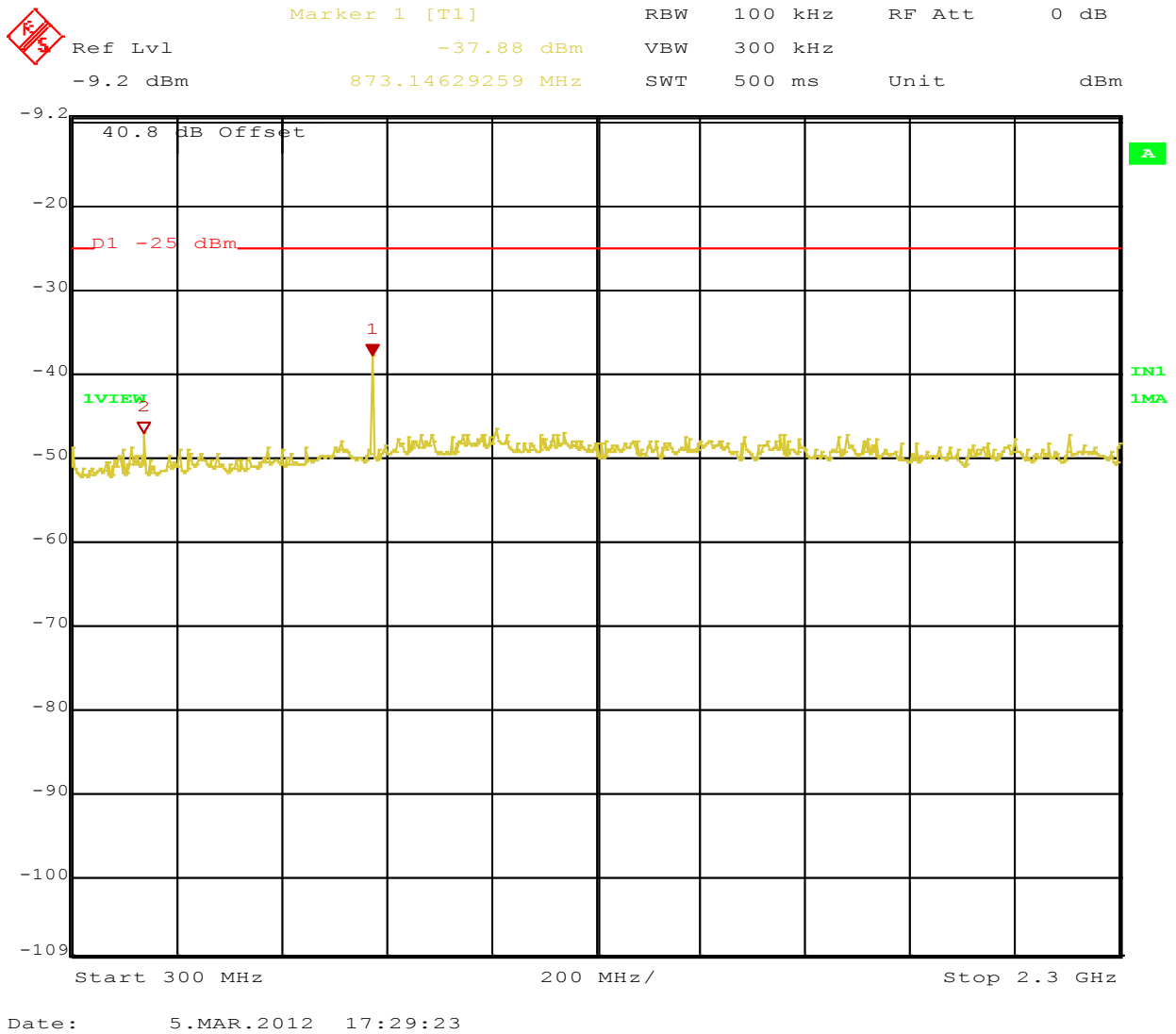

Figure 64: Out of Band Emissions Operating Channel 218.5 MHz, 32 QPSK Plot 2

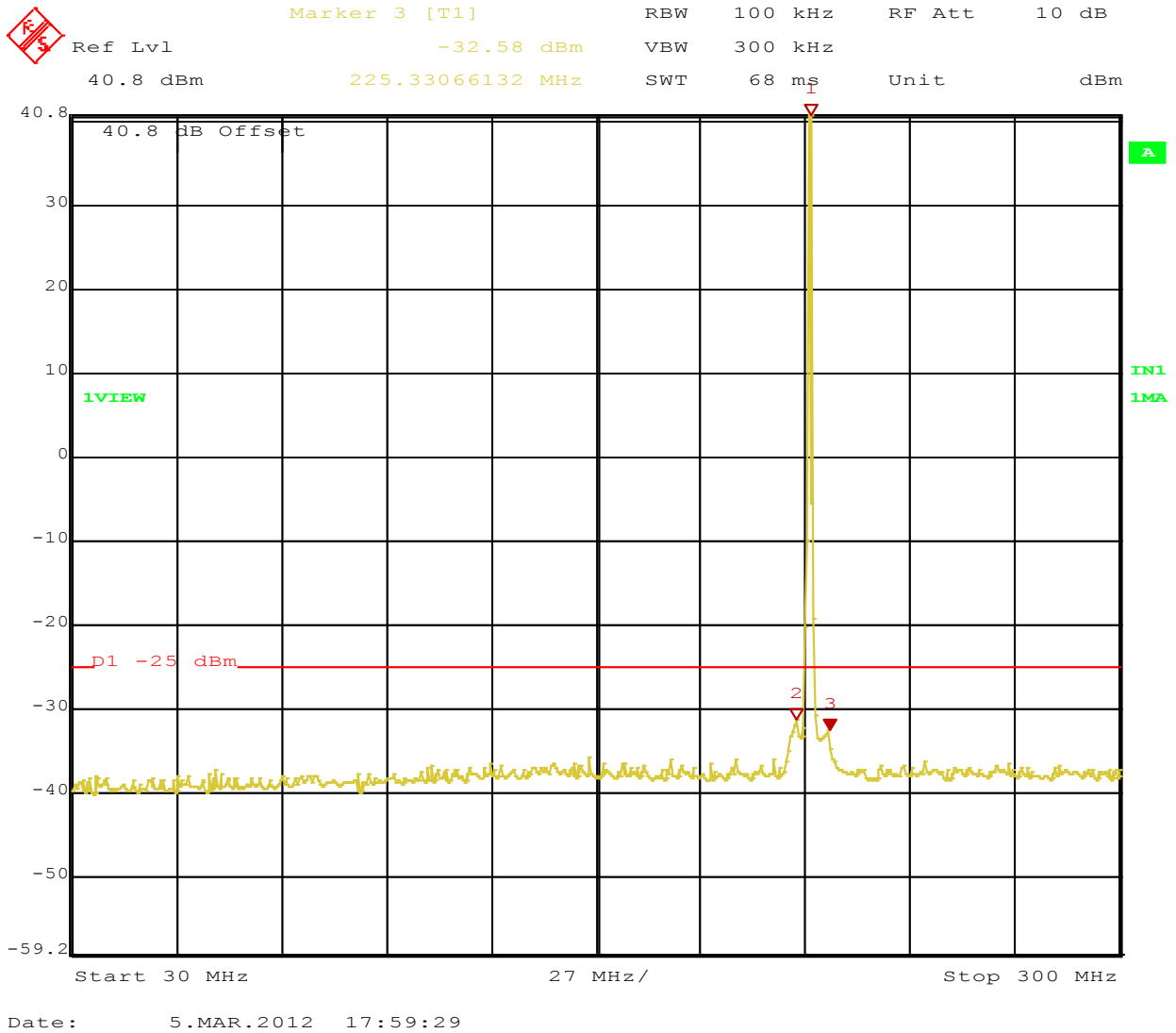

Figure 65: Out of Band Emissions Operating Channel 220.0125MHz, GMSK Plot 1

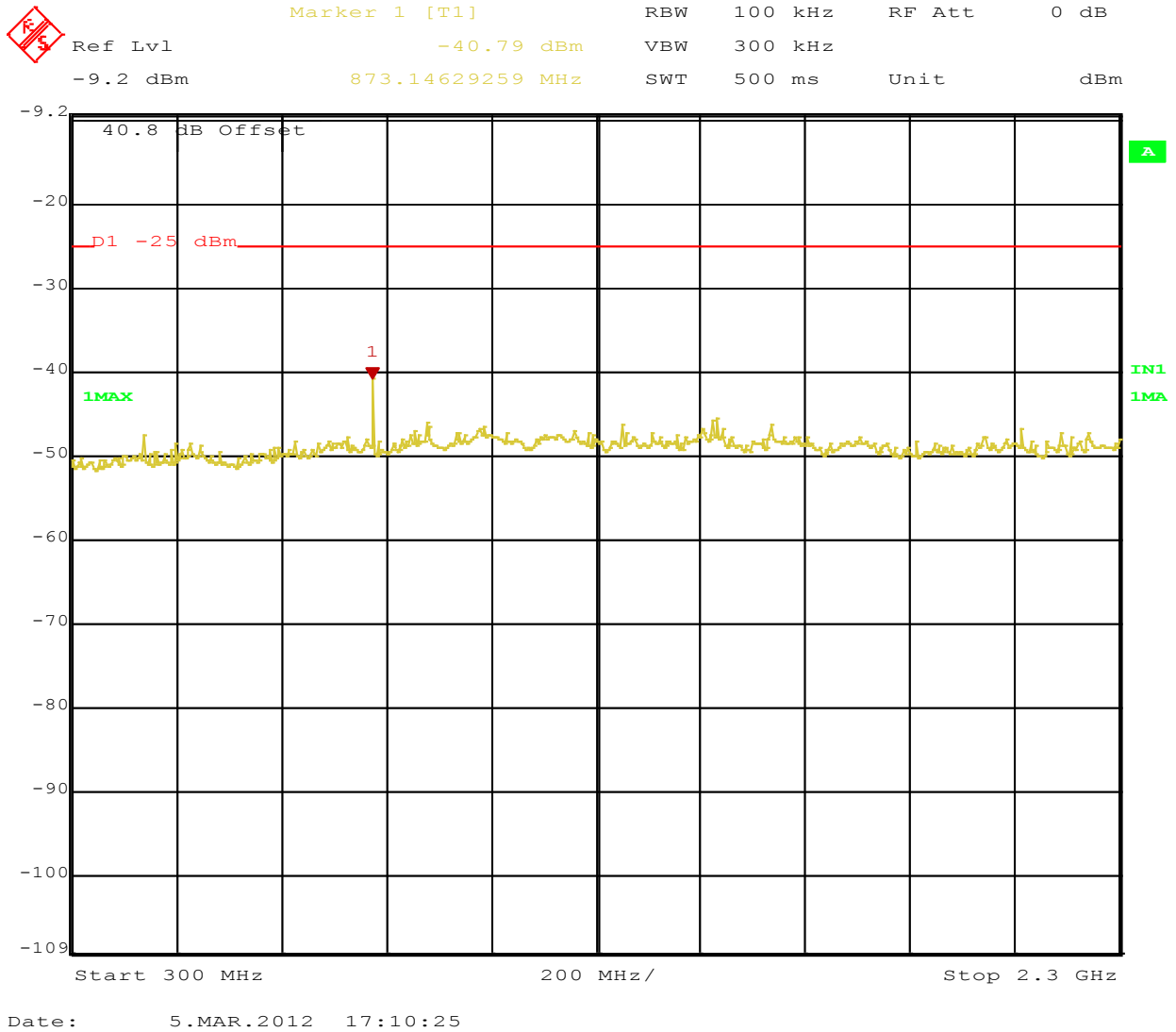

Figure 66: Out of Band Emissions Operating Channel 220.0125MHz, GMSK Plot 2

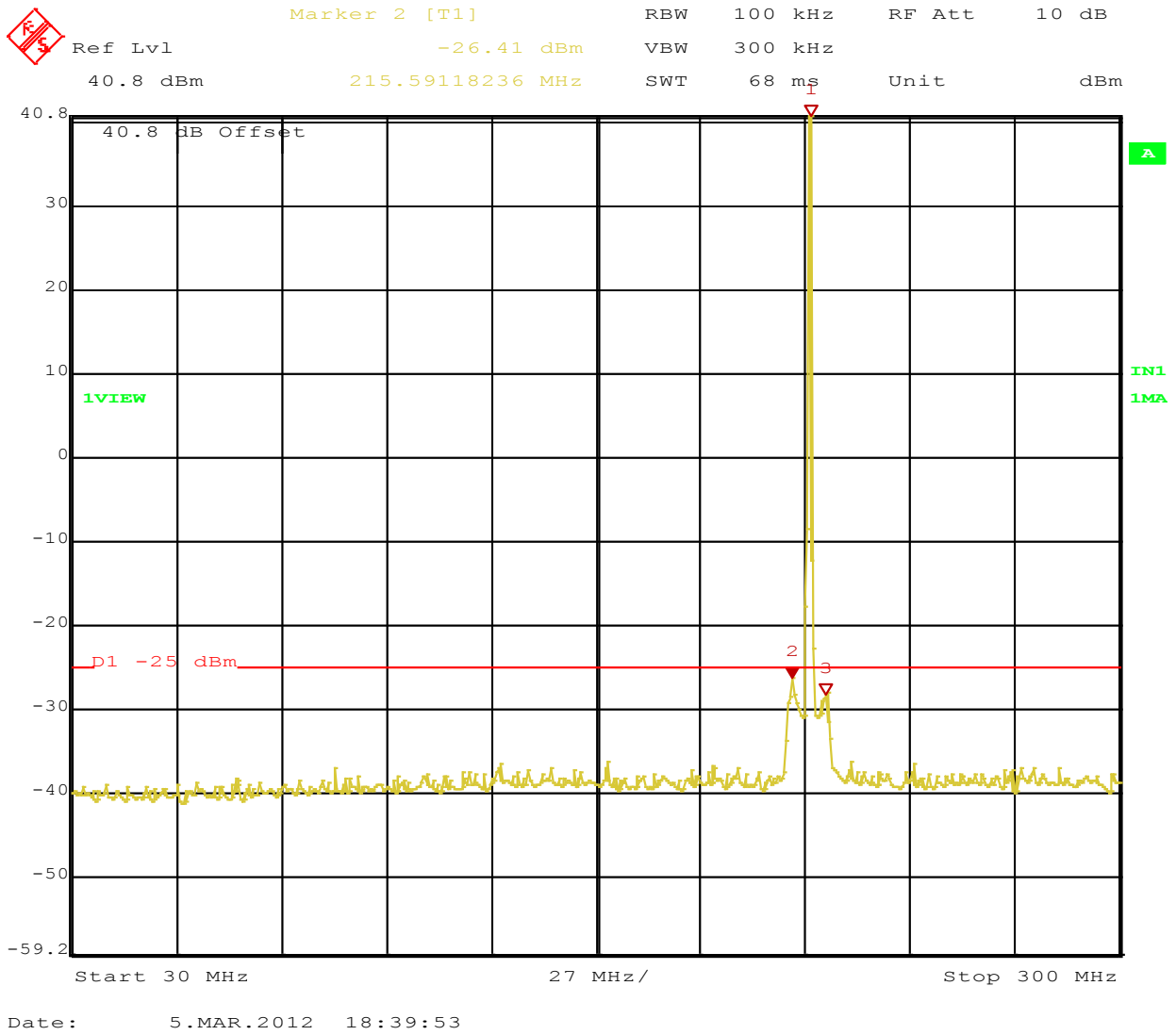

Figure 67: Out of Band Emissions Operating Channel 220.0125MHz, 16 QPSK Plot 1

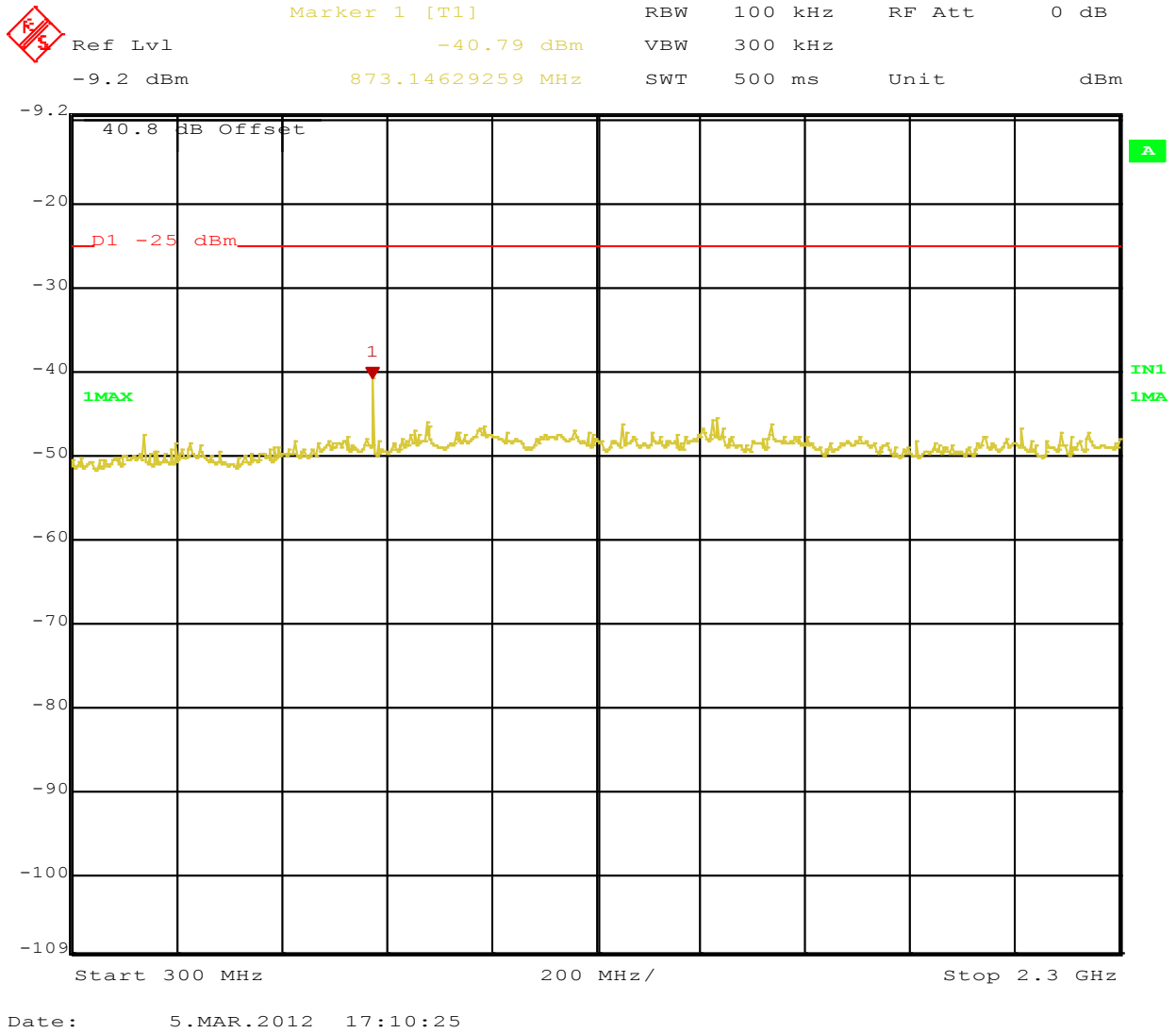

Figure 68: Out of Band Emissions Operating Channel 220.0125MHz, 16 QPSK Plot 2

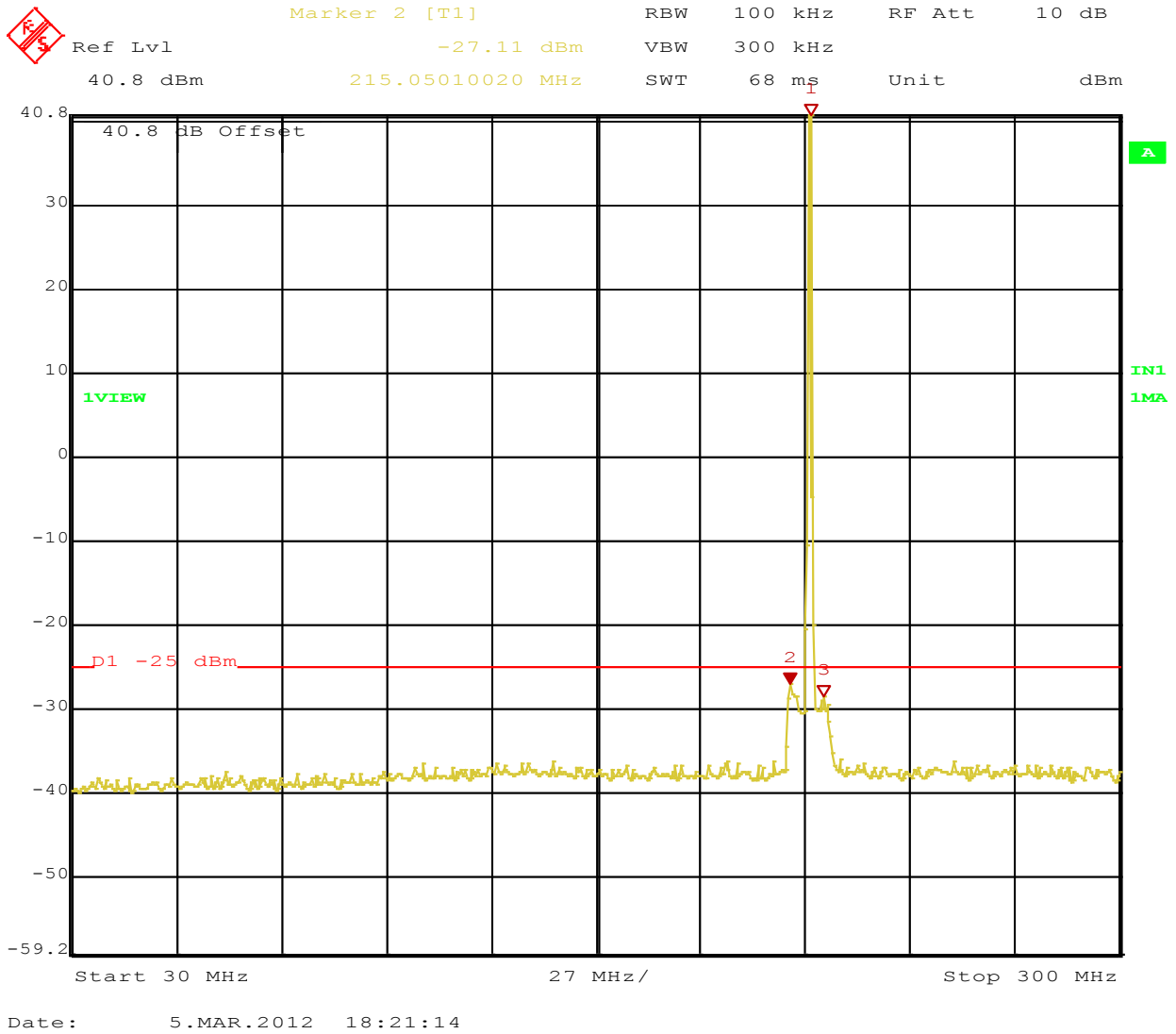
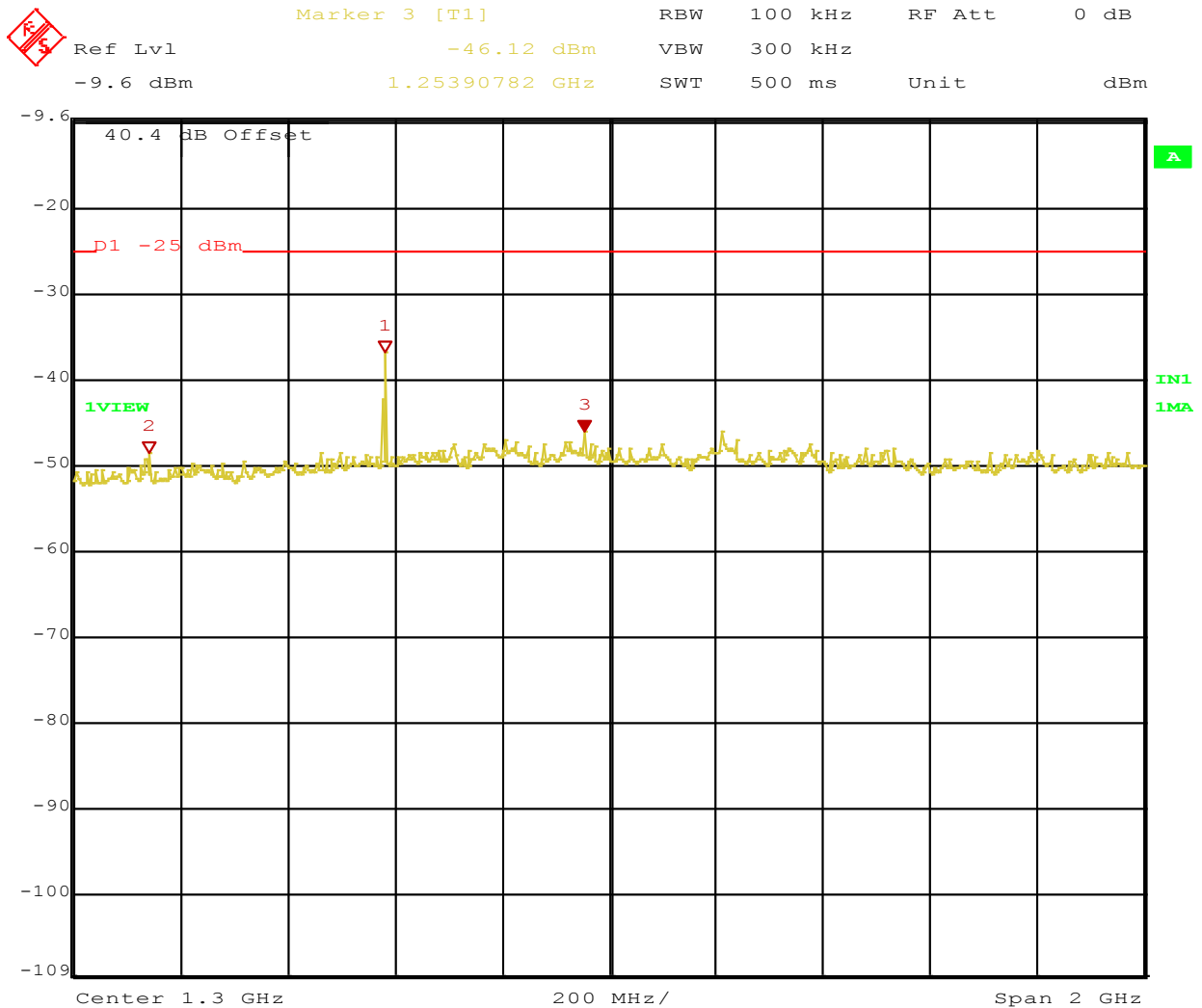

Figure 69: Out of Band Emissions Operating Channel 220.0125MHz, 32 QPSK Plot 1



Date: 5.MAR.2012 16:05:23

Figure 70: Out of Band Emissions Operating Channel 220.0125MHz, 32 QPSK Plot 2

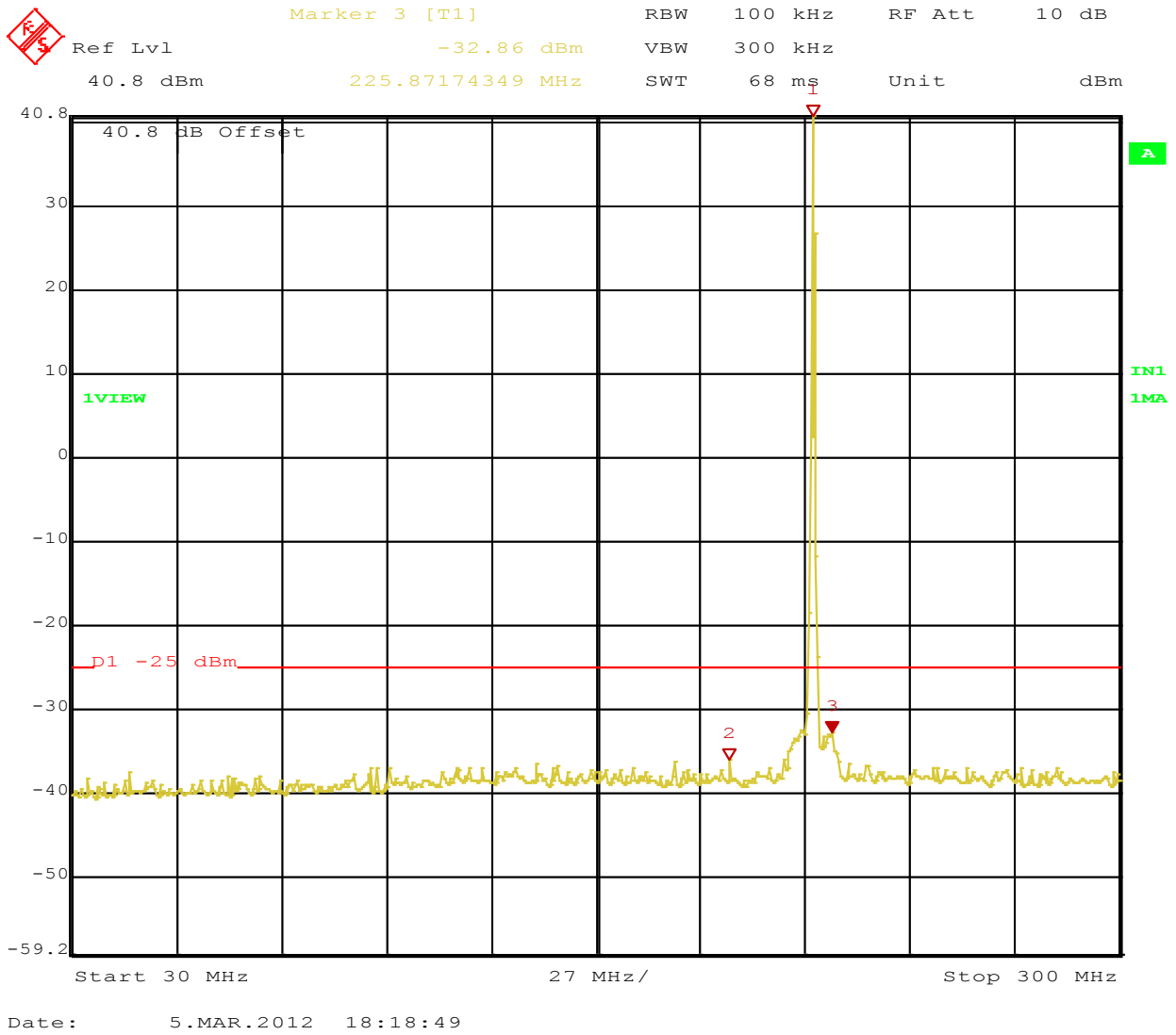

Figure 71: Out of Band Emissions Operating Channel 220.9875MHz, GMSK Plot 1

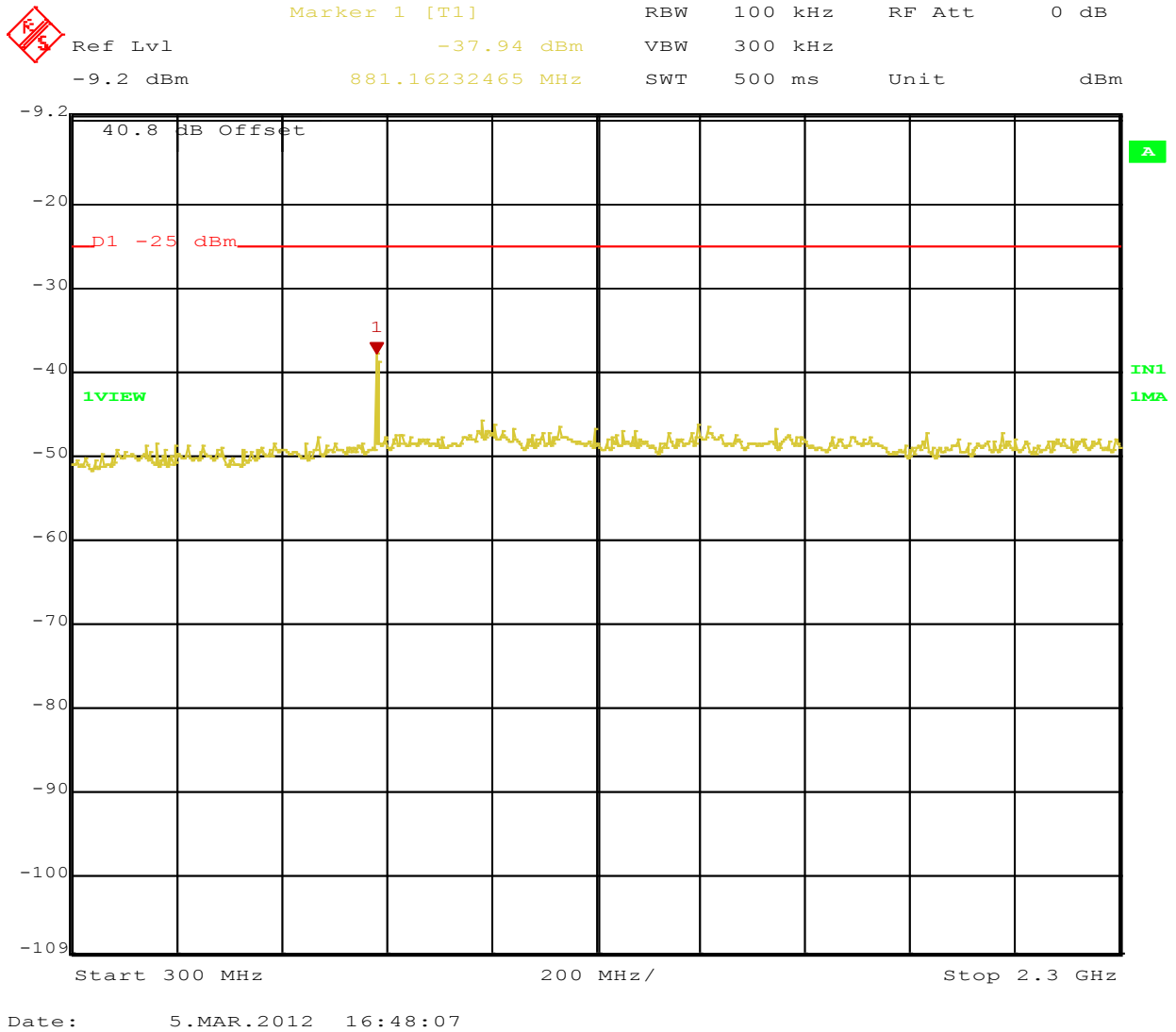

Figure 72: Out of Band Emissions Operating Channel 220.9875MHz, GMSK Plot 2

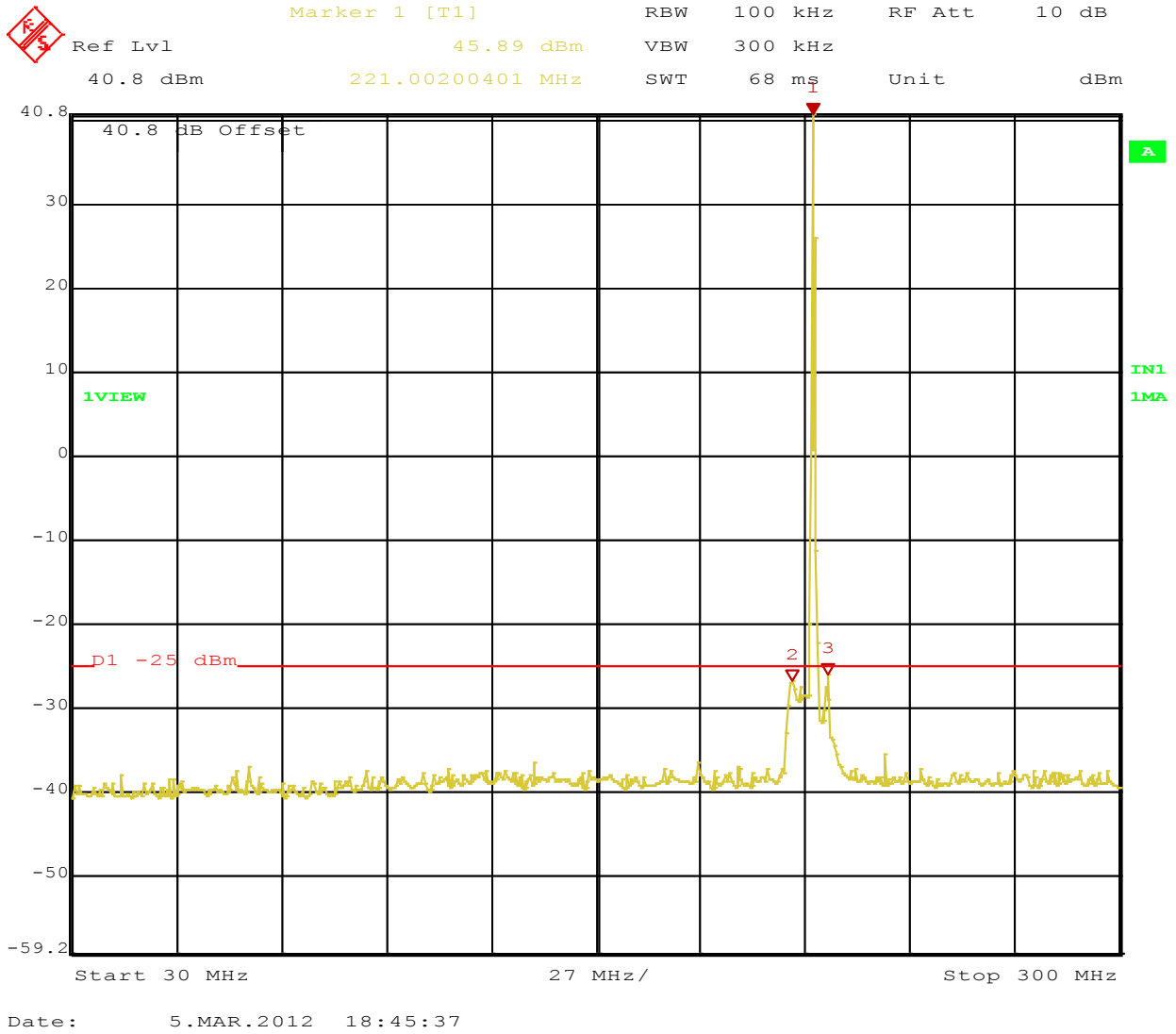

Figure 73: Out of Band Emissions Operating Channel 220.9875MHz, 16 QPSK Plot 1

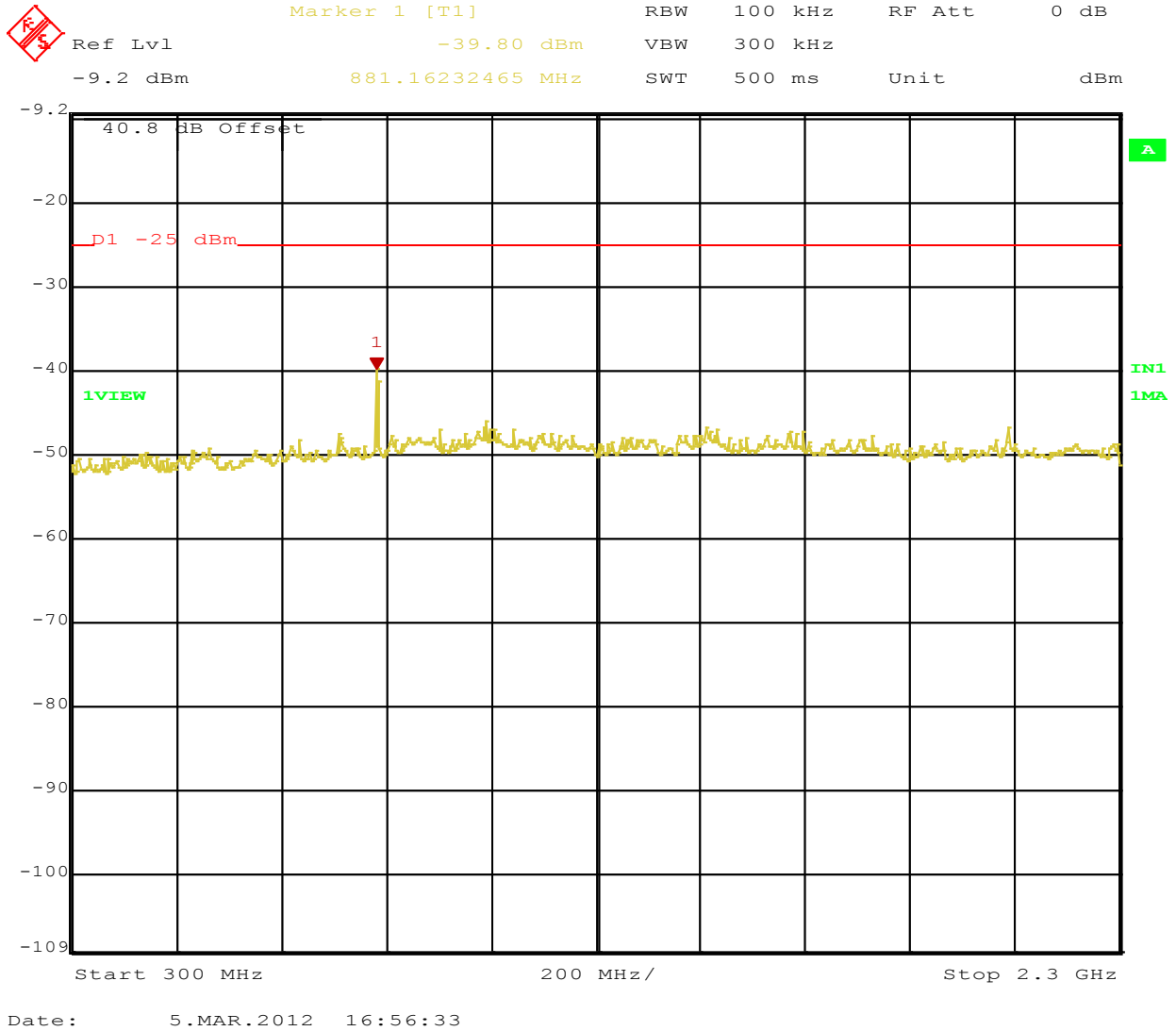

Figure 74: Out of Band Emissions Operating Channel 220.9875MHz, 16 QPSK Plot 2

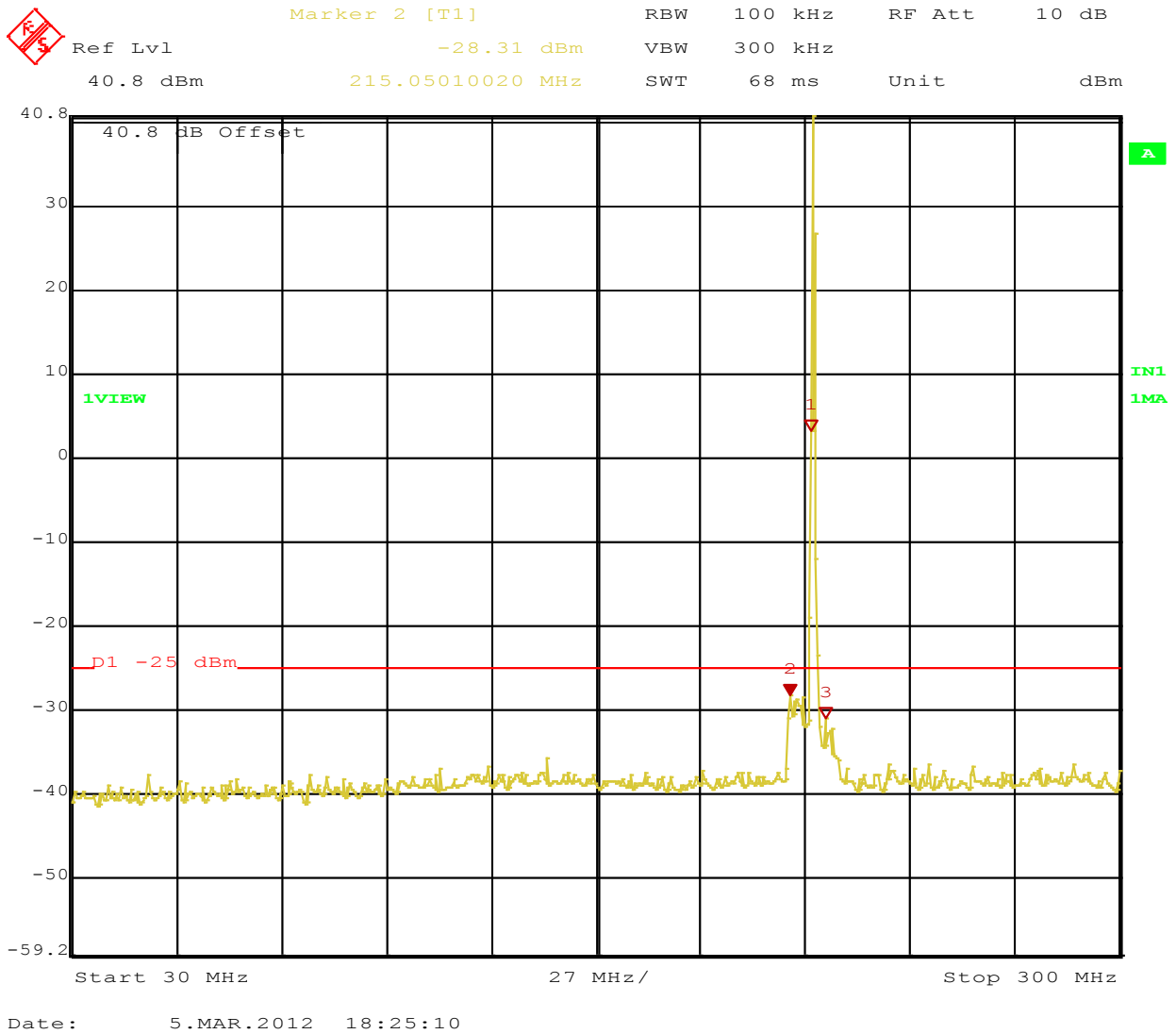

Figure 75: Out of Band Emissions Operating Channel 220.9875MHz, 32 QPSK Plot 1

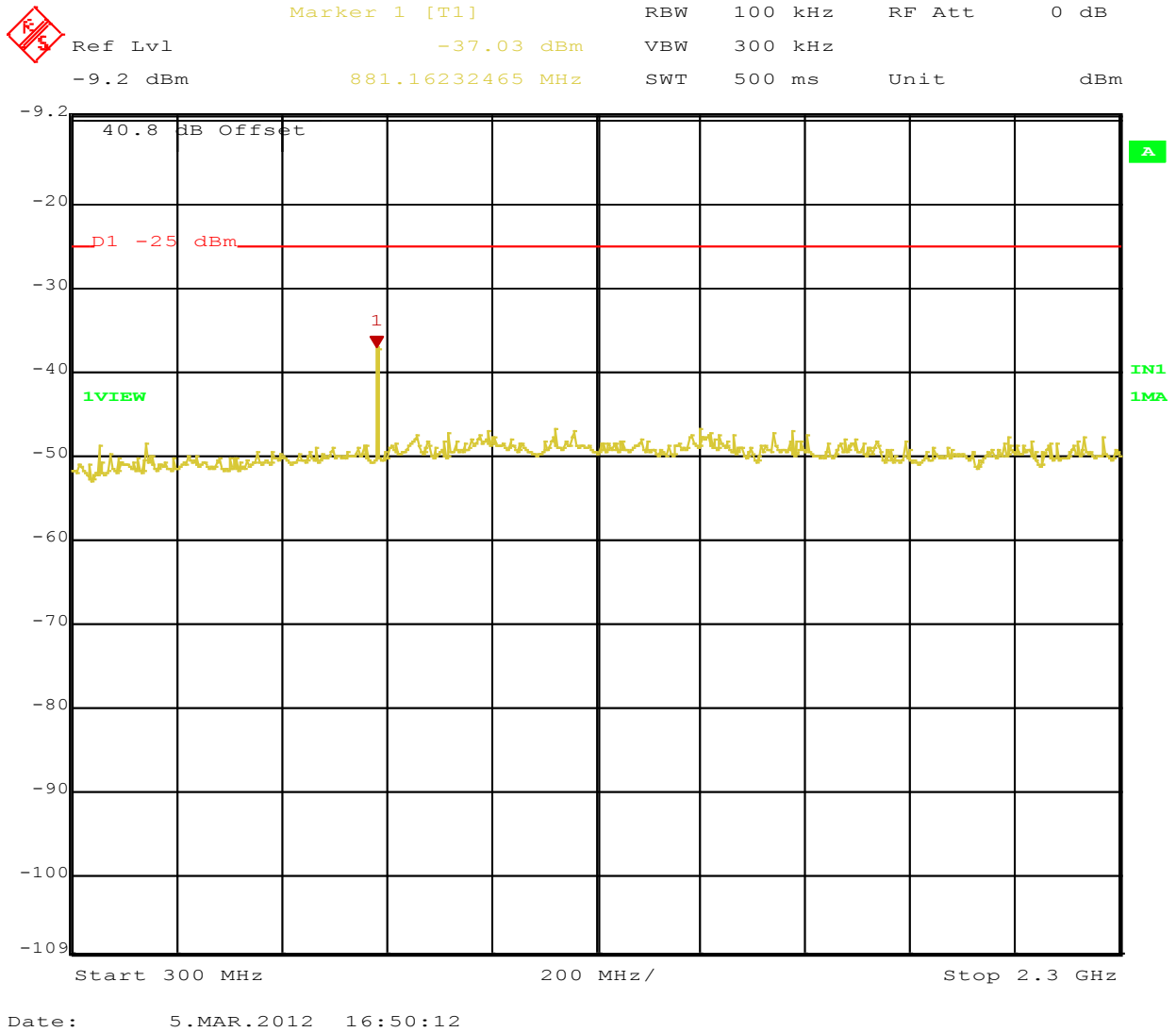

Figure 76: Out of Band Emissions Operating Channel 220.9875MHz, 32 QPSK Plot 2

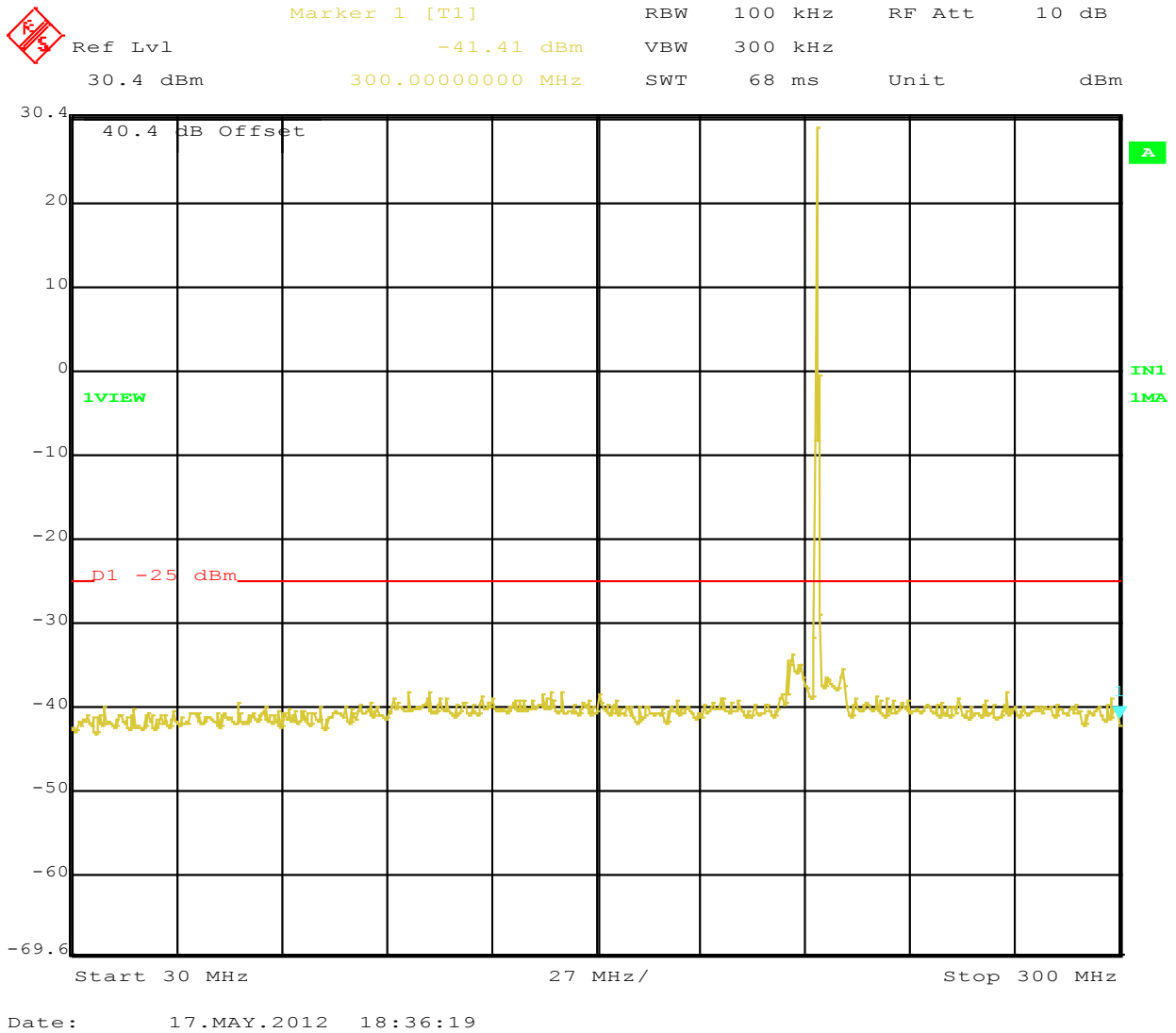
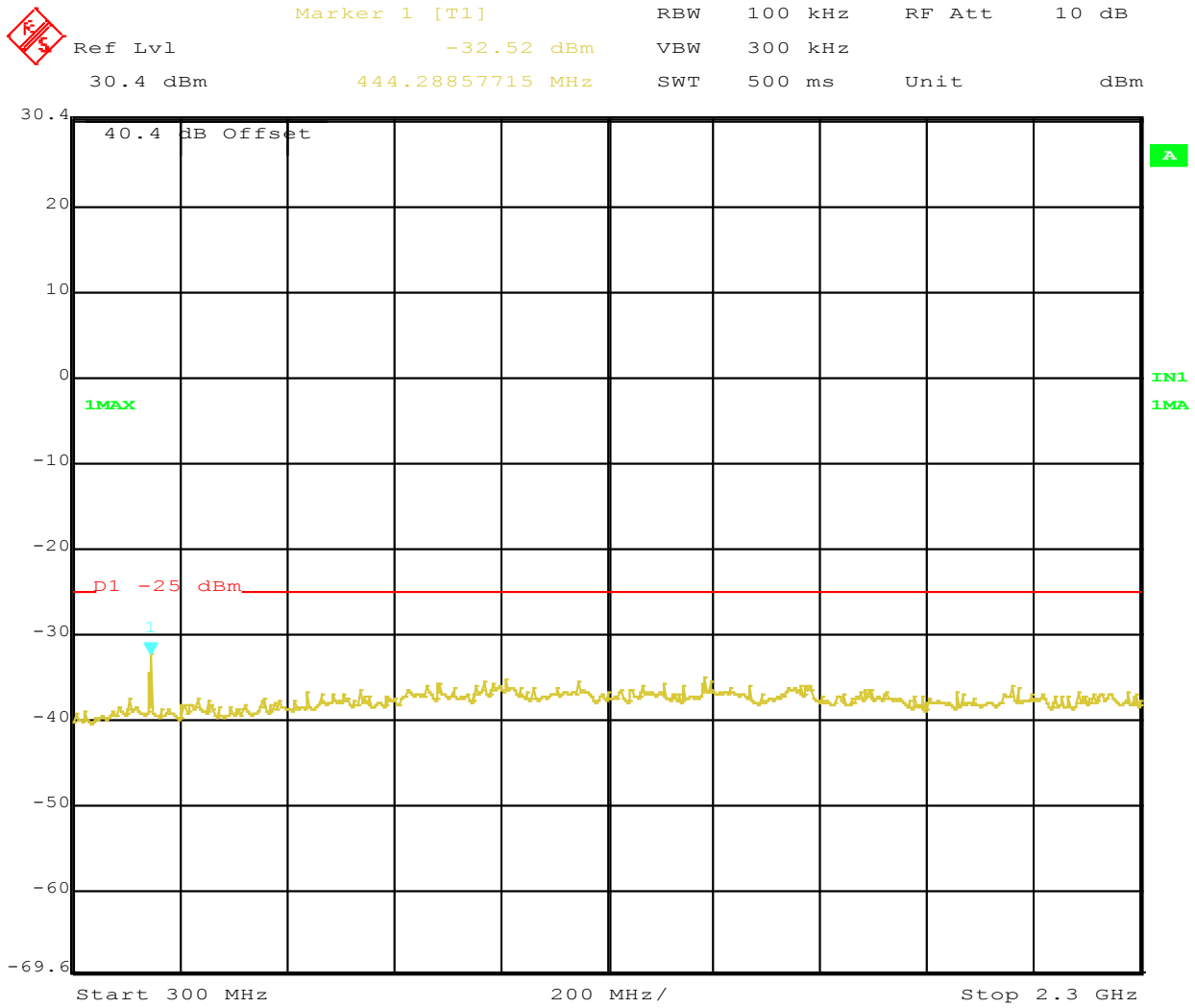

Figure 77: Out of Band Emissions Operating 222 MHz GMSK Plot 1



Date: 17.MAY.2012 18:32:32

Figure 78: Out of Band Emissions Operating 222 MHz GMSK Plot 2

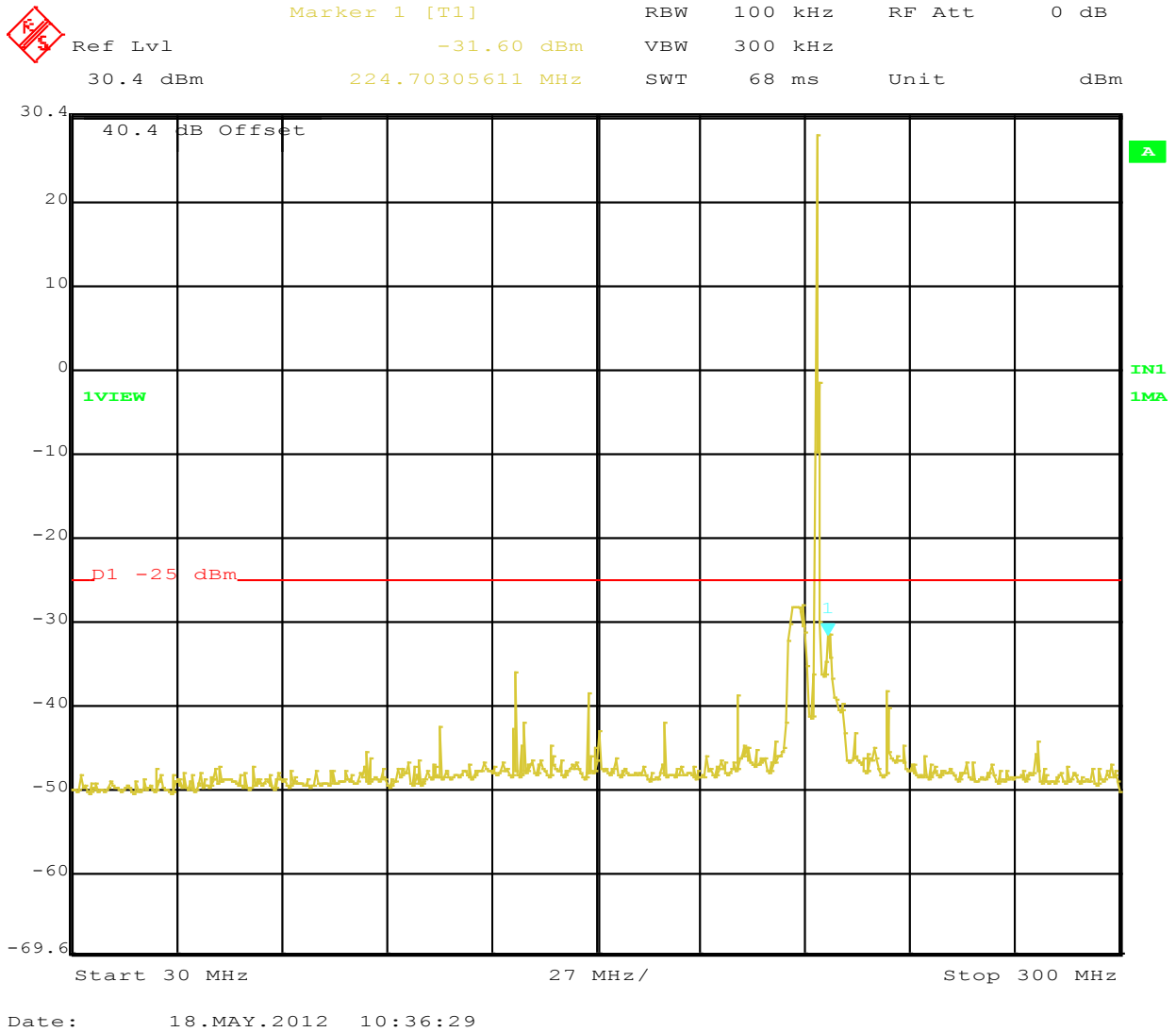

Figure 79: Out of Band Emissions Operating 222 MHz 16 QPSK Plot 1

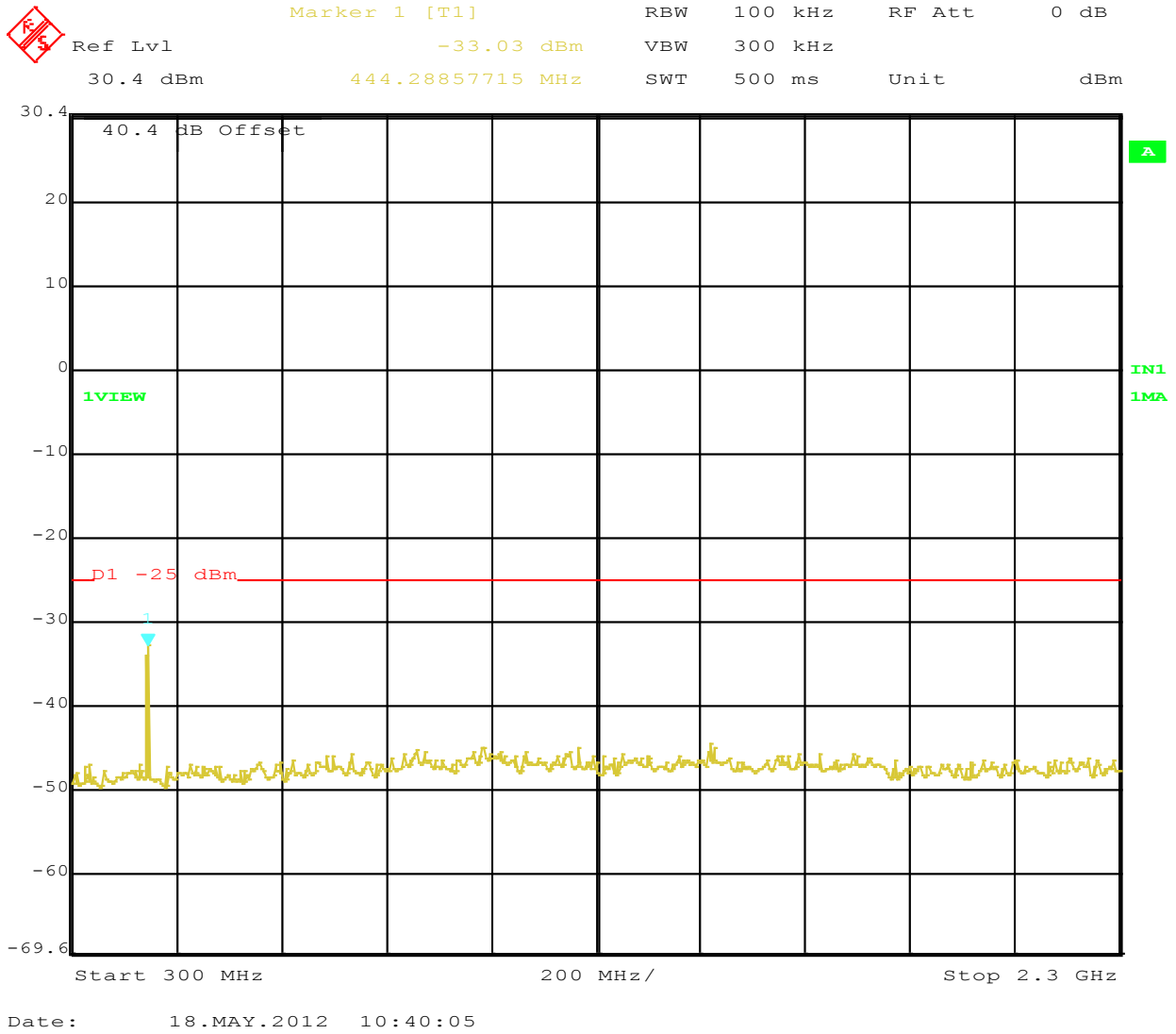

Figure 80: Out of Band Emissions Operating 222 MHz 16 QPSK Plot 2

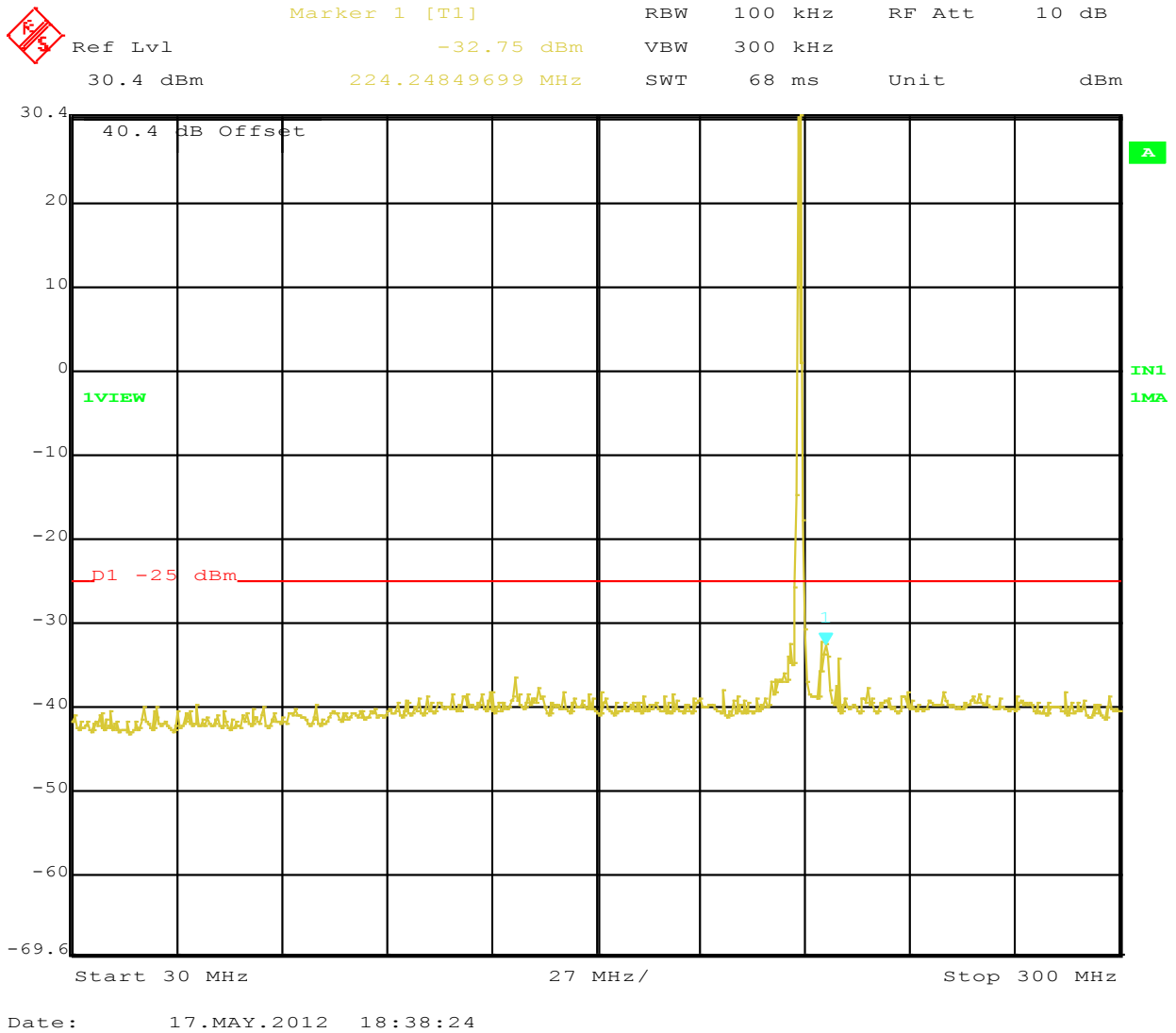
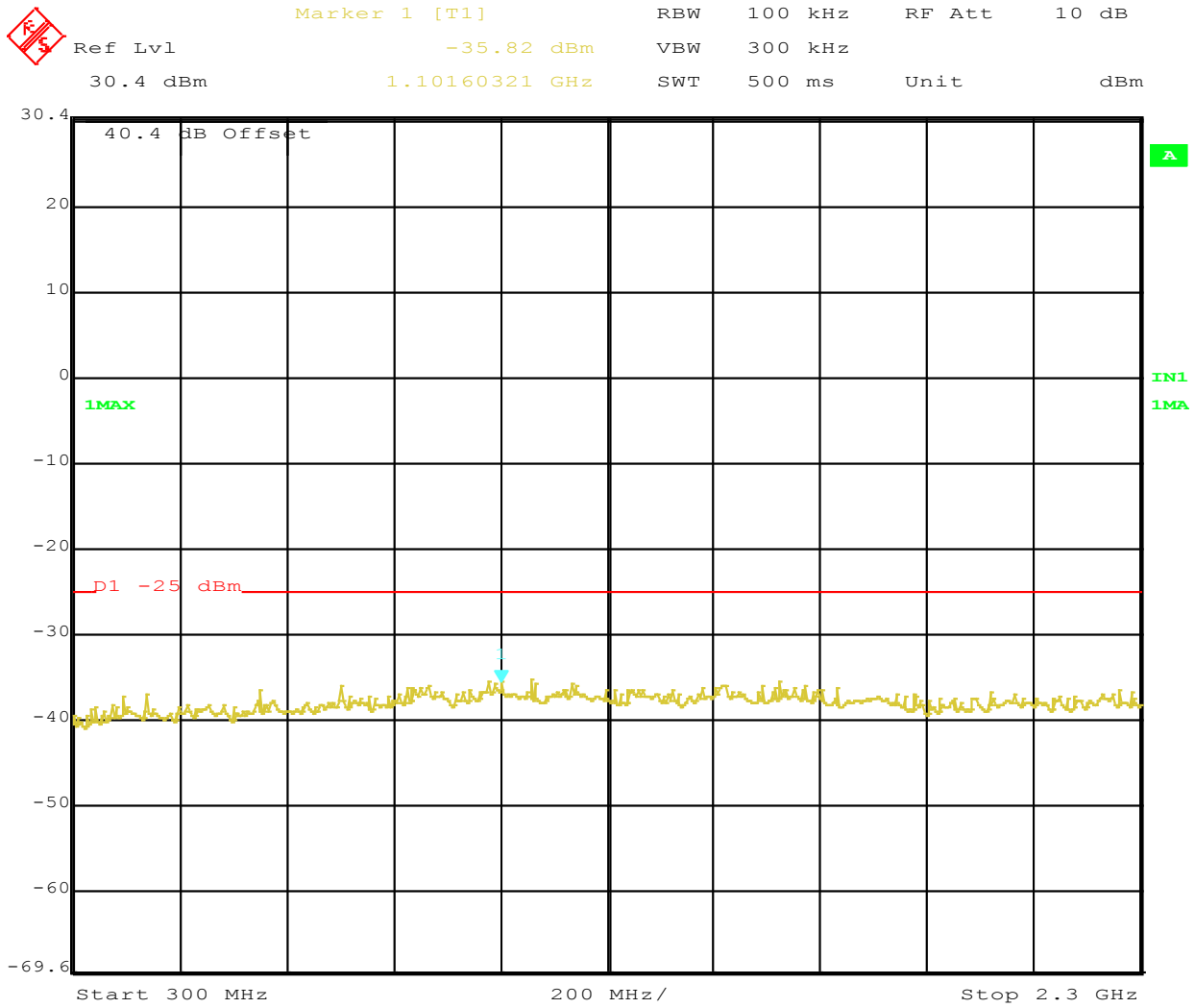

Figure 81: Out of Band Emissions Operating 222 MHz 32 QPSK Plot 1



Date: 17.MAY.2012 18:40:00

Figure 82: Out of Band Emissions Operating 222 MHz 32 QPSK Plot 2

4.4.3 Out of band emissions receive mode

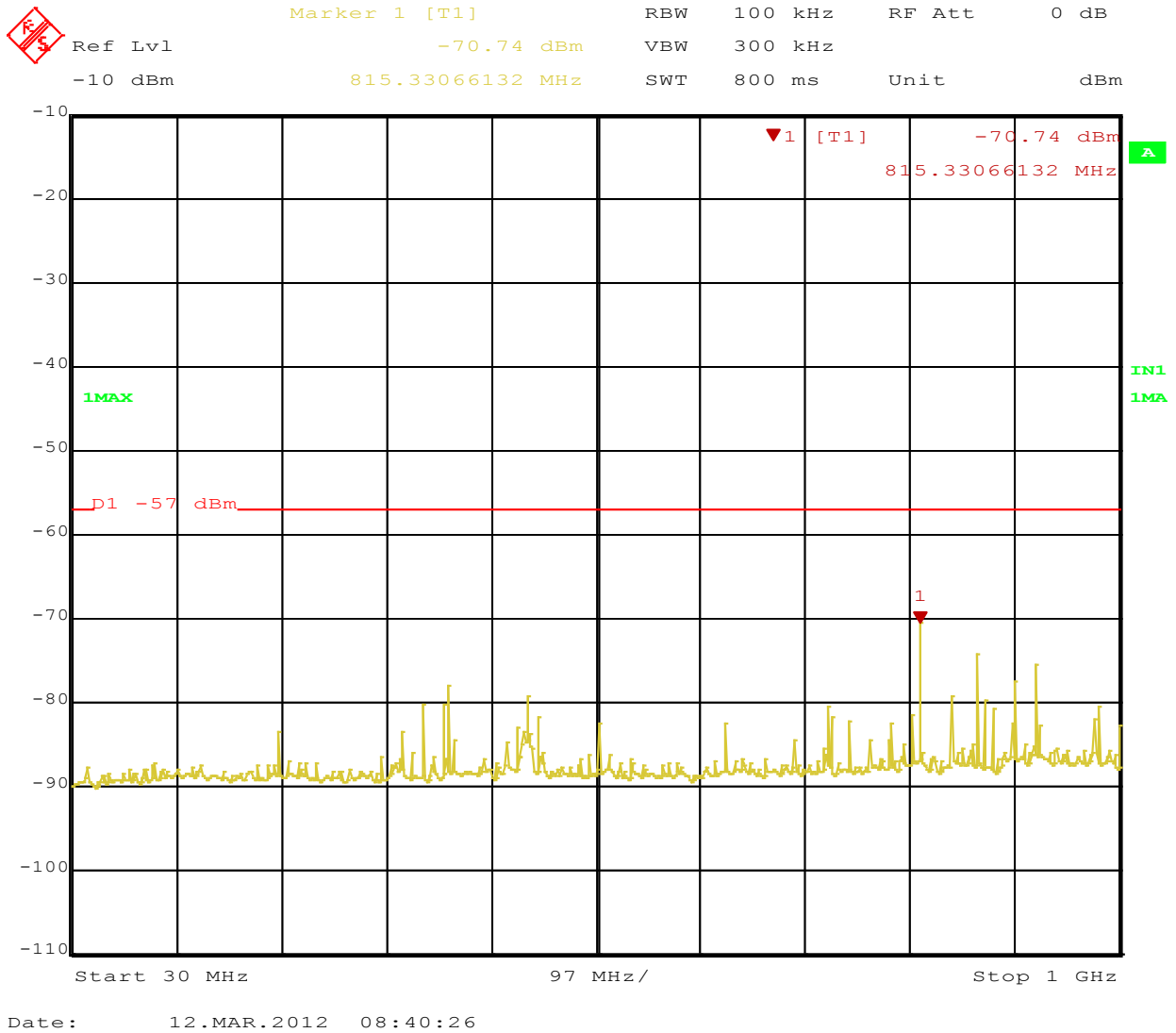

Figure 83: Out of Band Emissions Operating 217.5 MHz Receive Mode

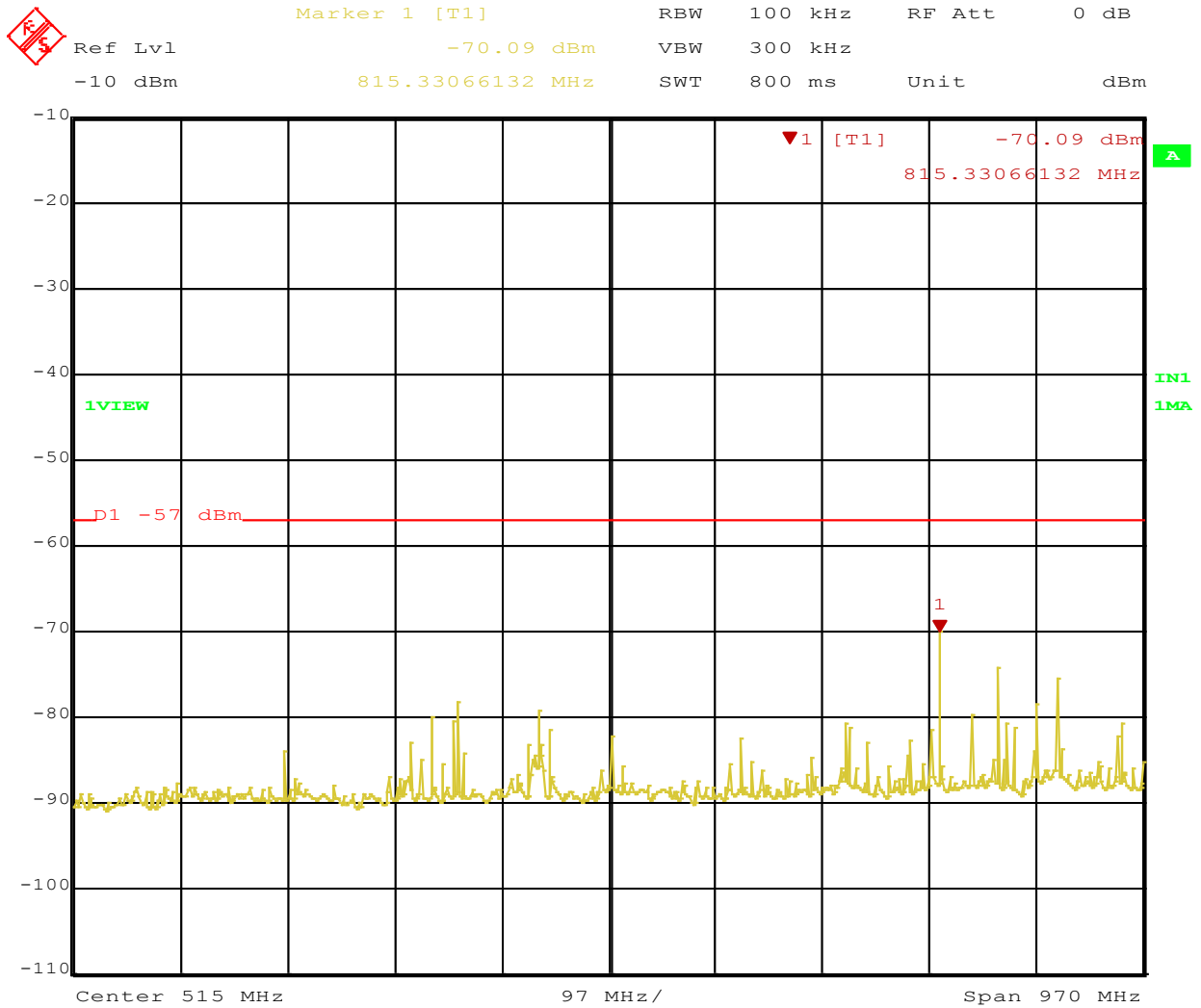

Figure 84: Out of Band Emissions Operating 220.9875 MHz Receive Mode

4.5 Transmitter Spurious Emissions

Transmitter spurious emissions are emissions outside the frequency range of the equipment when the equipment is in transmit mode; per requirement of CFR47 part 90.210, RSS 119 para 4.2.3

4.5.1 Test Methodology

4.5.1.1 Preliminary Test

A test program that controls instrumentation and data logging was used to automate the preliminary RF emission test procedure. The frequency range of interest was divided into sub-ranges to yield a frequency resolution of approximately 120 kHz and provide a reading at each frequency for no more than 12° of turntable rotation. For each frequency sub-range the turntable was rotated 360° while peak emission data was recorded and plotted over the frequency range of interest in horizontal and vertical antenna polarization's.

Preliminary emission profile testing was performed inside the anechoic chamber. The EUT was placed on a 1.0m x 1.5m non-conductive table 80cm above the floor. The EUT was positioned as shown in the setup photographs. The receiving antenna was placed at a distance of 3m at a fixed height of 1m. Measurement equipment was located outside of the chamber. A video camera was placed inside the chamber to view the EUT.

4.5.1.2 Final Test

For each frequency measured, the peak emission was maximized by manipulating the receiving antenna from 1 to 4 meters above the ground plane and placing it at the position that produced the maximum signal strength reading. The turntable was then rotated through 360° while observing the peak signal and placing the EUT at the position that produced maximum radiation. The six highest emissions relative to the limit were measured unless such emissions were more than 20 dB below the limit. If less than six emissions are within 20 dB of the limit, than the noise level of the receiver is measured at frequencies where emissions are expected. Multiples of all oscillator and microprocessor frequencies were also checked.

Final testing was performed on an NSA compliant test site. The EUT was placed on a 1.0m x 1.5m non-conductive table 80cm above the ground plane. The placement of EUT and cables were the same as for preliminary testing and is shown in the setup photographs.

Final

The final scans were performed on the worst axis, for three operating channels. Substitution method was used to obtain final results. Final test were performed on the following channels based on pre-scans

217.5MHz, 218.5MHz, 220.4875MHz and 222MHz

4.5.1.3 Deviations

None.

4.5.2 Transmitter Spurious Emission Limit

The spurious emissions of the transmitter shall not exceed the values in CFR47 Part 90 and RSS119

Emission limits are taken from Emission mask F

4.5.3 Test Results

The final measurement data was taken under the worst case operating modes, configurations, and/or cable positions. It also reflects the results including any modifications and/or special accessories listed in Sections 1.4 and Test Plan.

As originally tested, the EUT was found to be compliant to the requirements of the test standard(s).

SOP 1 Radiated Emissions

Tracking # 31260509.001 Page 1 of 15

EUT Name	TransAir PTC-3000	Date	03/07/2012
EUT Model	PTC-3000 RF	Temp / Hum in	23°C / 39%rh
EUT Serial	D1-5 (Host)	Temp / Hum out	N/A
EUT Config.	TX ON in 4MCU host	Line AC	12 Vdc
Standard	CFR47 Part 90	RBW / VBW	120 kHz/300 kHz
Dist/Ant Used	3m - EMCO3115 / 1m - RA42-K-F-4B-C	Performed by	Suresh Kondapalli

30 MHz to 1GHz Plot for Transmit Mode: QPSK 32Mbit/s

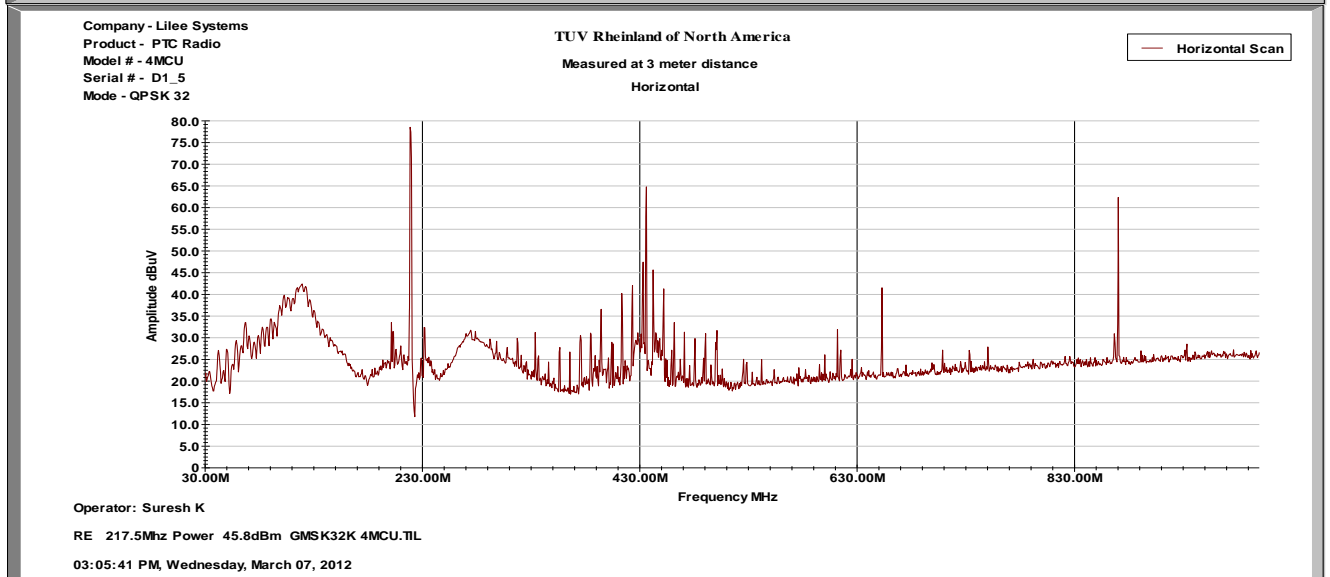
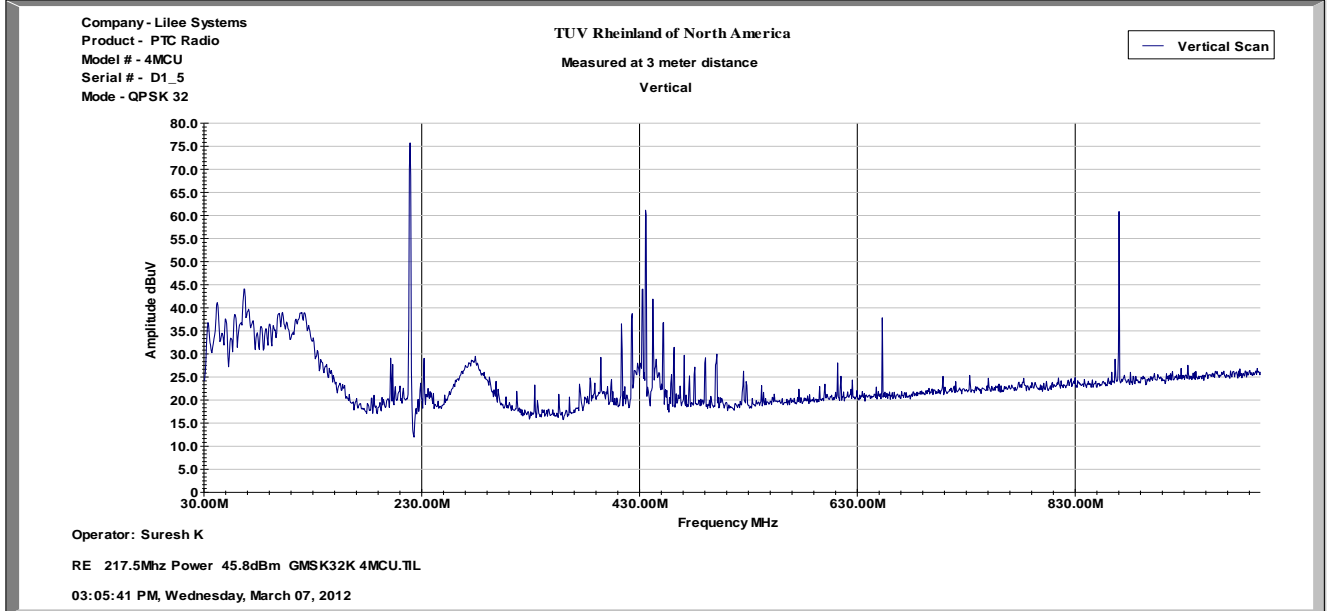

Notes:

SOP 1 Radiated Emissions					Tracking # 31260509.001 Page 2 of 15					
EUT Name		TransAir PTC-3000			Date		03/07/2012			
EUT Model		PTC-3000 RF			Temp / Hum in		23°C / 39%rh			
EUT Serial		D1-5 (host)			Temp / Hum out		N/A			
EUT Config.		TX ON in 4MCU host			Line AC / Freq		DC 12Volts			
Standard		CFR47 Part 15 Subpart C			RBW / VBW		120 kHz/300 kHz			
Dist/Ant Used		3m / EMCO3115 / 1m - RA42-K-F-4B-C			Performed by		Suresh Kondapalli			
Frequency	Peak	Gen	Cable	Antenna	EIRP	Antenna	Table	Height	Limit	Margin
MHz	dBuV/m	dBm	dB	dbi	dBm	POL	deg	cm	dBm	dB
Transmitted Data at 217.5 MHz GMSK/16QPSK/32 QPSK										
42.25	56.84	-33.07	0.98	-8.90	-42.95	V	30	100	-25.00	-17.95
67.00	63.14	-31.38	1.17	-1.00	-33.56	V	204	100	-25.00	-8.56
119.43	52.00	-45.14	1.50	-2.10	-48.74	H	88	200	-25.00	-23.74
413.42	51.55	-53.02	2.65	5.90	-49.77	H	164	100	-25.00	-24.77
423.22	57.00	-47.47	2.68	5.90	-44.24	H	164	100	-25.00	-19.24
432.00	56.10	-48.42	2.71	6.04	-45.09	H	164	100	-25.00	-20.09
435.00	74.60	-29.99	2.72	6.10	-26.61	H	164	100	-25.00	-1.61
441.60	55.08	-49.41	2.73	6.20	-45.94	H	164	100	-25.00	-20.94
452.00	50.00	-54.39	2.77	6.26	-50.89	H	164	100	-25.00	-25.89
652.40	47.37	-56.91	3.28	6.30	-53.89	H	198	150	-25.00	-28.89
870.35	64.91	-39.22	3.88	6.70	-36.40	H	215	100	-25.00	-11.40
Spec Margin = E-Field QP - Limit, E-Field QP = FIM QP+ Total CF ± Uncertainty										
Total CF= Amp Gain + Cable Loss + ANT Factor										
Combined Standard Uncertainty $u_c(y) = \pm 3.2$ dB Expanded Uncertainty $U = k u_c(y)$ $k = 2$ for 95% confidence										
Notes : Table combines all data rate/modulations										

SOP 1 Radiated Emissions					Tracking # 31260509.001 Page 3 of 15					
EUT Name	TransAir PTC-3000				Date	March 7, 2012				
EUT Model	PTC-3000 RF				Temp / Hum in	23°C / 39%rh				
EUT Serial	D1-5 (Host)				Temp / Hum out	N/A				
EUT Config.	TX module in Host				Line AC / Freq	12 Vdc				
Standard	CFR47 Part 15 part 90				RBW / VBW	120/300 kHz				
Dist/Ant Used	3m / EMCO3115 / 1m - RA42-K-F-4B-C				Performed by	Suresh Kondapalli				
Frequency	Peak	Gen	Cable Loss	Antenna Gain	EIRP	Antenna	Table	Height	Limit	Margin
MHz	dBuV/m	dBm	dB	dbi	dBm	POL	deg	cm	dBm	dB
Transmitted Data 218.5 MHz GMSK/16QPSK/32 QPSK										
42.25	57.17	-32.74	0.98	-8.90	-42.62	V	329	100	-25.00	-17.62
66.75	63.30	-31.28	1.17	-1.02	-33.47	V	213	150	-25.00	-8.47
121.88	54.50	-42.21	1.51	-2.06	-45.78	H	97	185	-25.00	-20.78
413.42	47.14	-57.43	2.65	5.90	-54.18	H	324	102	-25.00	-29.18
423.20	52.36	-52.11	2.68	5.90	-48.88	H	150	102	-25.00	-23.88
432.00	56.61	-47.91	2.71	6.04	-44.58	H	150	102	-25.00	-19.58
436.99	74.15	-30.38	2.72	6.14	-26.96	H	139	102	-25.00	-1.96
441.60	54.85	-49.64	2.73	6.20	-46.17	H	136	102	-25.00	-21.17
451.40	49.98	-54.37	2.76	6.27	-50.86	H	154	102	-25.00	-25.86
655.90	50.80	-53.54	3.31	6.35	-50.49	H	224	150	-25.00	-25.49
874.00	65.20	-38.96	3.88	6.70	-36.15	H	194	102	-25.00	-11.15
Spec Margin = E-Field QP - Limit, E-Field QP = FIM QP+ Total CF ± Uncertainty										
Total CF= Amp Gain + Cable Loss + ANT Factor										
Combined Standard Uncertainty $u_c(y) = \pm 3.2$ dB Expanded Uncertainty $U = ku_c(y)$ $k = 2$ for 95% confidence										
Notes EUT is Class A device										
Table combines all data rates/modulations										

SOP 1 Radiated Emissions

Tracking # 31260509.001 Page 4 of 15

EUT Name	TransAir PTC-3000	Date	March 07, 2012
EUT Model	PTC-3000 RF	Temp / Hum in	23°C / 40%rh
EUT Serial	D1-5 (host)	Temp / Hum out	N/A
EUT Config.	TX module in Host	Line AC	12 Vdc
Standard	CFR47 Part 90	RBW / VBW	120/300 kHz
Dist/Ant Used	3m - EMCO3115 / 1m - RA42-K-F-4B-C	Performed by	Suresh Kondapalli

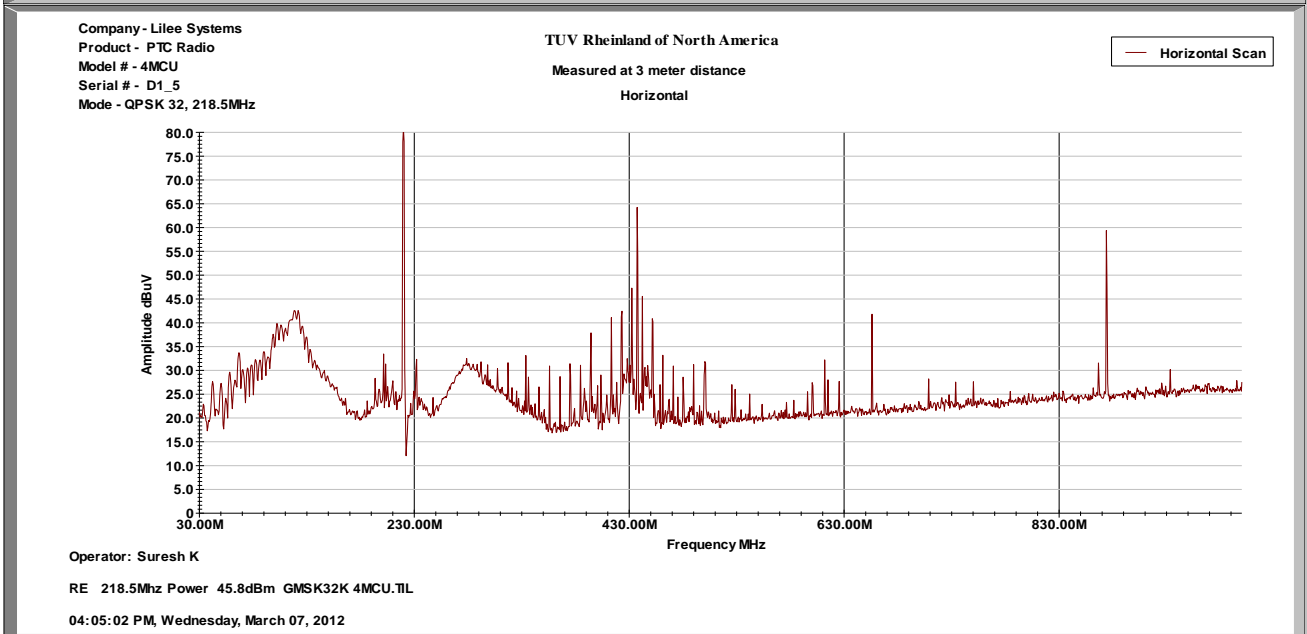
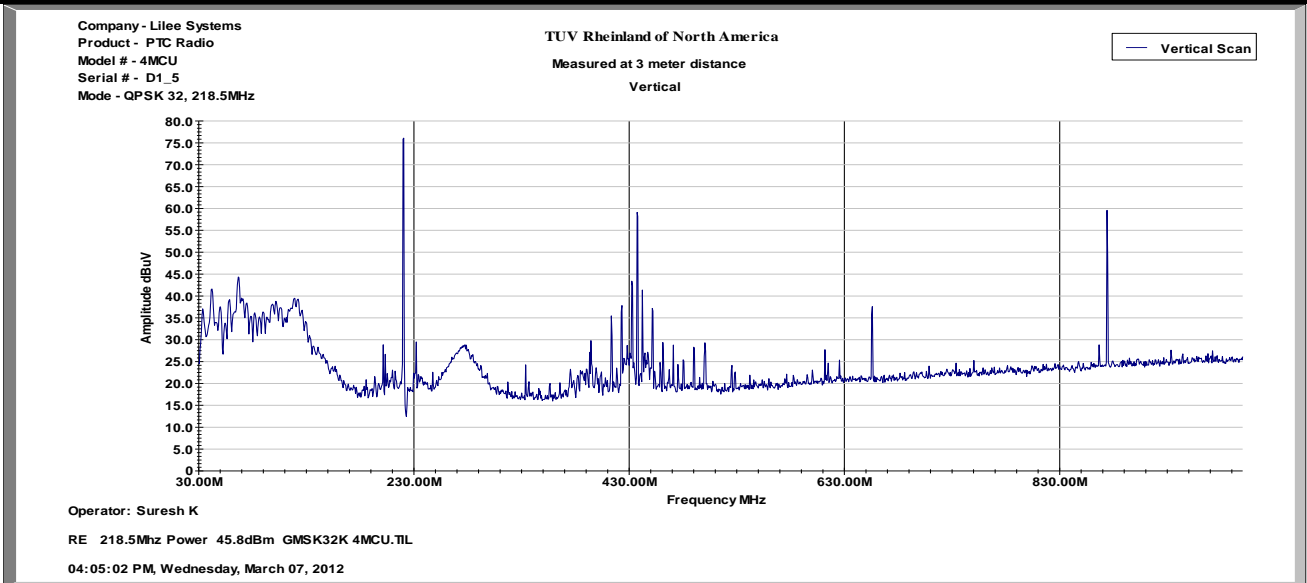

Notes:

SOP 1 Radiated Emissions

Tracking # 31260509.001 Page 5 of 15

EUT Name	TransAir PTC-3000	Date	03/08/2012
EUT Model	PTC-3000 RF	Temp / Hum in	23°C / 39%rh
EUT Serial	D1-5 (host)	Temp / Hum out	N/A
EUT Config.	TX ON is host	Line AC	12 Vdc
Standard	CFR47 Part 15 Part 90	RBW / VBW	120 kHz/300 kHz
Dist/Ant Used	3m - EMCO3115 / 1m - RA42-K-F-4B-C	Performed by	Suresh Kondapalli

1 to 2.5GHz Plot for Transmit Mode: Operating Freq 220.4875MHz att0 max power

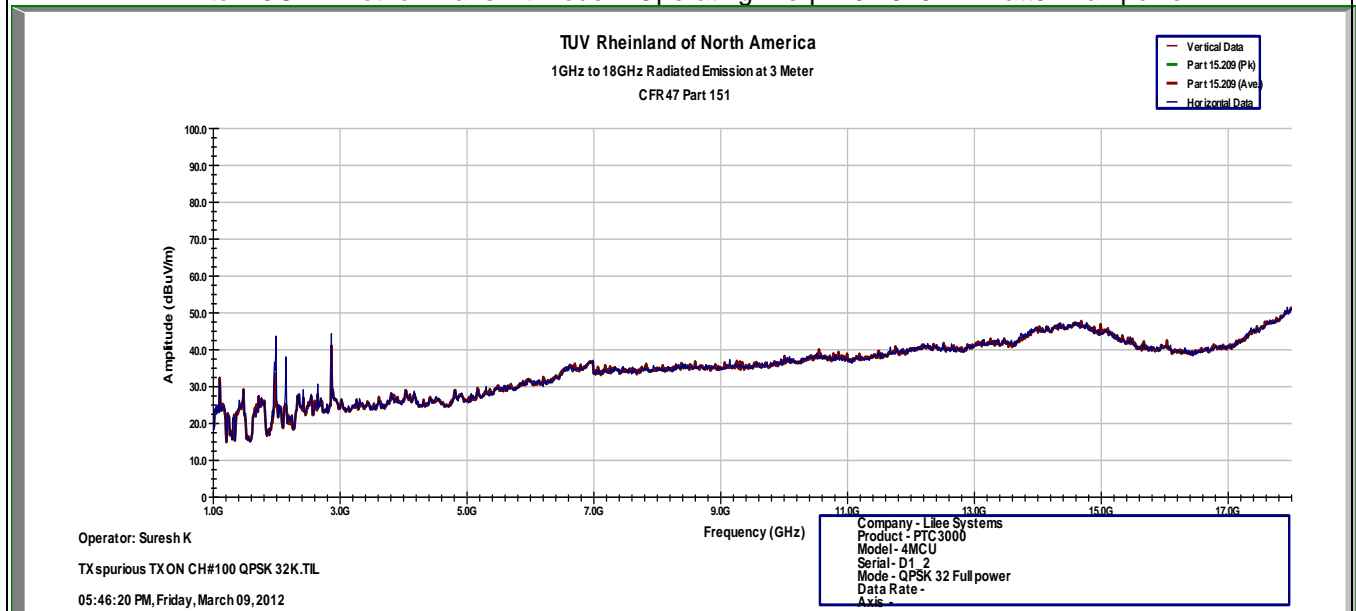

Notes: None

SOP 1 Radiated Emissions						Tracking # 31260509.001 Page 6 of 15				
EUT Name		TransAir PTC-3000				Date		03/07/2012		
EUT Model		PTC-3000 RF				Temp / Hum in		23°C / 39%rh		
EUT Serial		D1-5 (host)				Temp / Hum out		N/A		
EUT Config.		TX Module in 4MCU Host				Line AC / Freq		DC 12Volts		
Standard		CFR47 Part 15 Subpart C				RBW / VBW		120 kHz/300 kHz		
Dist/Ant Used		3m / EMCO3115 / 1m - RA42-K-F-4B-C				Performed by		Suresh Kondapalli		
Frequency Peak	Gen	Cable Loss	Antenna Gain	EIRP	Antenna	Table	Height	Limit	Margin	
MHz	dBuV/m	dBm	dB	dbi	dBm	POL	deg	cm	dBm	dB
Transmitted Data GMSK/16QPSK/32 QPSK all Channels combined										
1102.49	41.73	72	1.24	6.76	-24.48	V	17	121	-25.0	-36.24
1466.78	35.21	72.2	1.34	7.76	-23.58	V	40	111	-25.0	-36.34
1984.48	37.88	79.3	1.5	8.81	-22.69	H	54	148	-25.0	-36.50
2125.76	35.99	73.4	1.7	9.32	-22.38	H	35	143	-25.0	-36.70
2666.8	28.94	53.5	1.7	9.41	-22.29	H	48	143	-25.0	-36.70
2866.52	45.92	73.4	1.8	9.41	-22.39	H	38	137	-25.0	-36.80
Spec Margin = E-Field QP - Limit, E-Field QP = FIM QP+ Total CF ± Uncertainty										
Total CF= Amp Gain + Cable Loss + ANT Factor										
Combined Standard Uncertainty $u_c(y) = \pm 3.2$ dB Expanded Uncertainty $U = ku_c(y)$ $k = 2$ for 95% confidence										
Notes: EUT is Class A device; Table combines all data rates/modulations GMSK/16QPSK/32 QPSK										

SOP 1 Radiated Emissions

Tracking # 31260509.001 Page 7 of 15

EUT Name	TransAir PTC-3000	Date	March 07, 2012
EUT Model	PTC-3000 RF	Temp / Hum in	23°C / 40%rh
EUT Serial	D1-5 (host)	Temp / Hum out	N/A
EUT Config.	GMSK Max power	Line AC	12 Vdc
Standard	CFR47 Part 15 Part9	RBW / VBW	120 kHz/300 kHz
Dist/Ant Used	3m - EMCO3115 / 1m - RA42-K-F-4B-C	Performed by	Suresh Kondapalli

Operating Freq 220.4875MHz GMSK

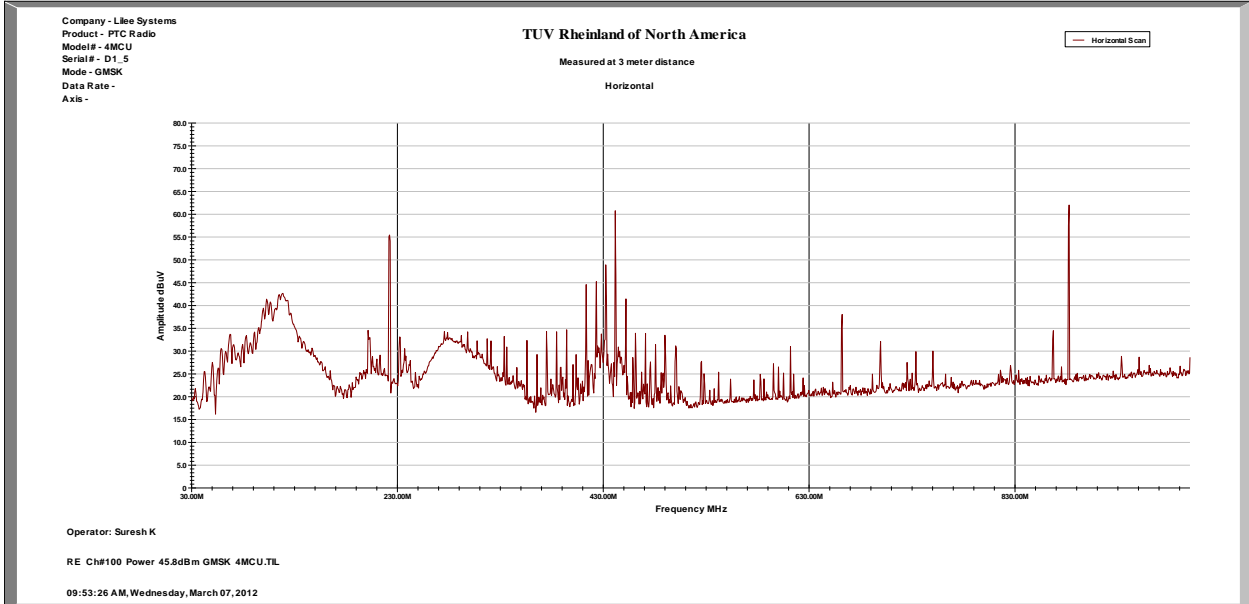
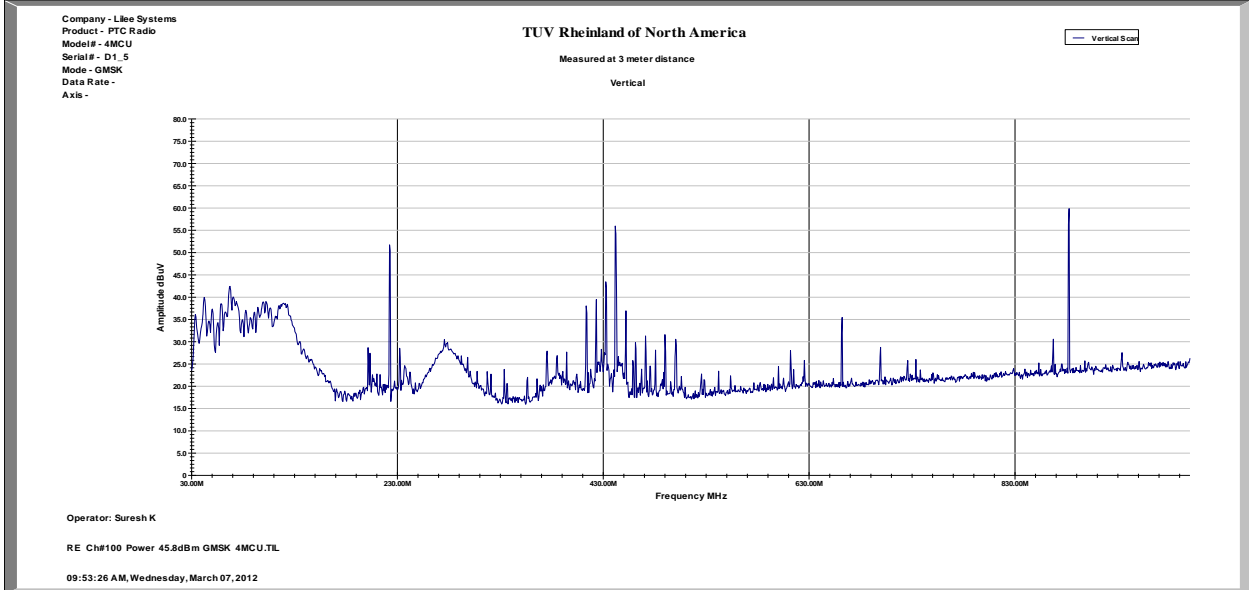

Notes:

SOP 1 Radiated Emissions						Tracking # 31260509.001 Page 9 of 15				
EUT Name		TransAir PTC-3000				Date		March 7, 2012		
EUT Model		PTC-3000 RF				Temp / Hum in		23°C / 39%rh		
EUT Serial		D1-5 (host)				Temp / Hum out		N/A		
EUT Config.		TX module in host				Line AC / Freq		120Vac/60Hz		
Standard		CFR47 Part 15 Part90				RBW / VBW		120/300 kHz		
Dist/Ant Used		3m / EMCO3115 / 1m - RA42-K-F-4B-C				Performed by		Suresh Kondapalli		
Frequency	Peak	Gen	Cable Loss	Antenna Gain	EIRP	Antenna	Table	Height	Limit	Margin
MHz	dBuV/m	dBm	dB	dbi	dBm	POL	deg	cm	dBm	dB
Transmitted Data 220.4875 GMSK										
42.25	56.50	-33.41	0.98	-8.90	-43.29	V	12	100	-25	-18.29
67.36	61.11	-33.35	1.17	-0.86	-35.38	V	185	100	-25	-10.38
118.81	54.80	-42.30	1.50	-2.10	-45.89	H	98	200	-25	-20.89
201.70	48.27	-55.19	1.90	3.68	-53.41	H	98	149	-25	-28.41
413.43	52.62	-51.95	2.65	5.90	-48.70	H	136	100	-25	-23.70
423.40	53.90	-50.56	2.68	5.90	-47.34	H	136	100	-25	-22.34
441.05	69.81	-34.72	2.73	6.20	-31.25	H	136	100	-25	-6.25
451.20	49.69	-54.66	2.76	6.28	-51.14	H	136	100	-25	-26.14
452.00	44.52	-57.76	2.77	6.50	-54.02	V	60	150	-25	-29.02
661.49	42.76	-61.58	3.35	6.60	-58.33	H	218	149	-25	-33.33
882.00	59.32	-44.85	3.91	6.64	-42.12	H	172	100	-25	-17.12
882.00	56.40	-44.92	3.91	7.00	-41.82	V	87	150	-25	-16.82
Spec Margin = E-Field QP - Limit, E-Field QP = FIM QP+ Total CF ± Uncertainty										
Total CF= Amp Gain + Cable Loss + ANT Factor										
Combined Standard Uncertainty $u_c(y) = \pm 3.2$ dB Expanded Uncertainty $U = ku_c(y)$ $k = 2$ for 95% confidence										
Notes EUT is Class A device										

SOP 1 Radiated Emissions

Tracking # 31260509.001 Page 10 of 15

EUT Name	TransAir PTC-3000	Date	March 07, 2012
EUT Model	PTC-3000 RF	Temp / Hum in	23°C / 40%rh
EUT Serial	D1-5 (host)	Temp / Hum out	N/A
EUT Config.	16QPSk max power in host device	Line AC	12 Vdc
Standard	CFR47 Part 15 Part90	RBW / VBW	120/300 kHz
Dist/Ant Used	3m - EMCO3115 / 1m - RA42-K-F-4B-C	Performed by	Suresh Kondapalli

Operating Freq 220.4875MHz 16QPSK

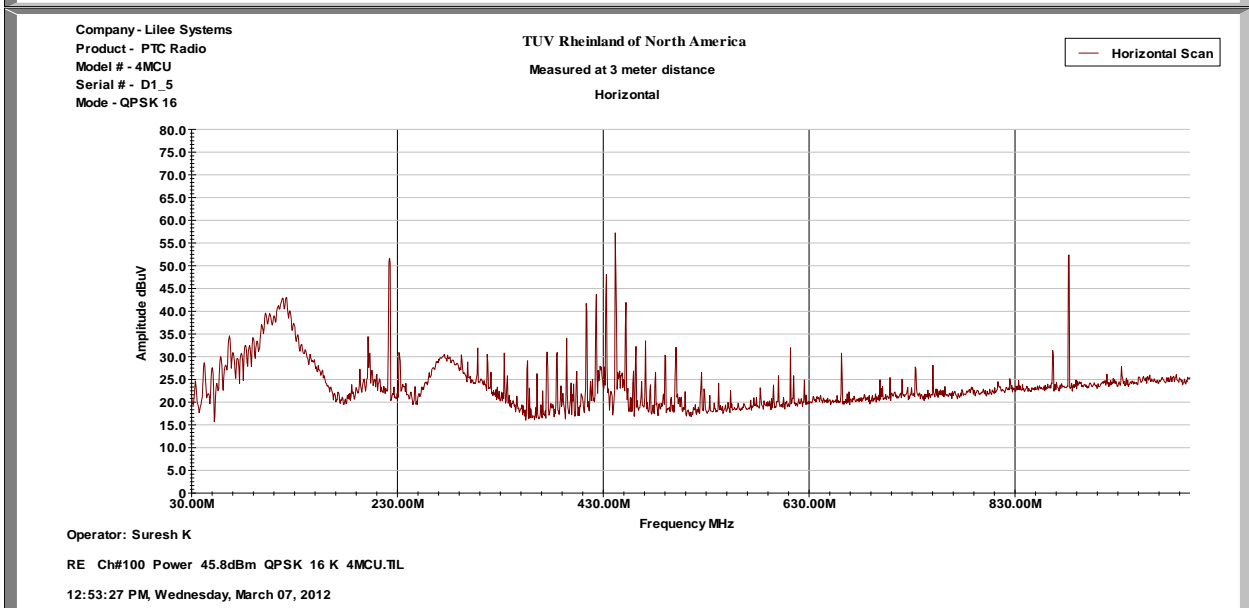
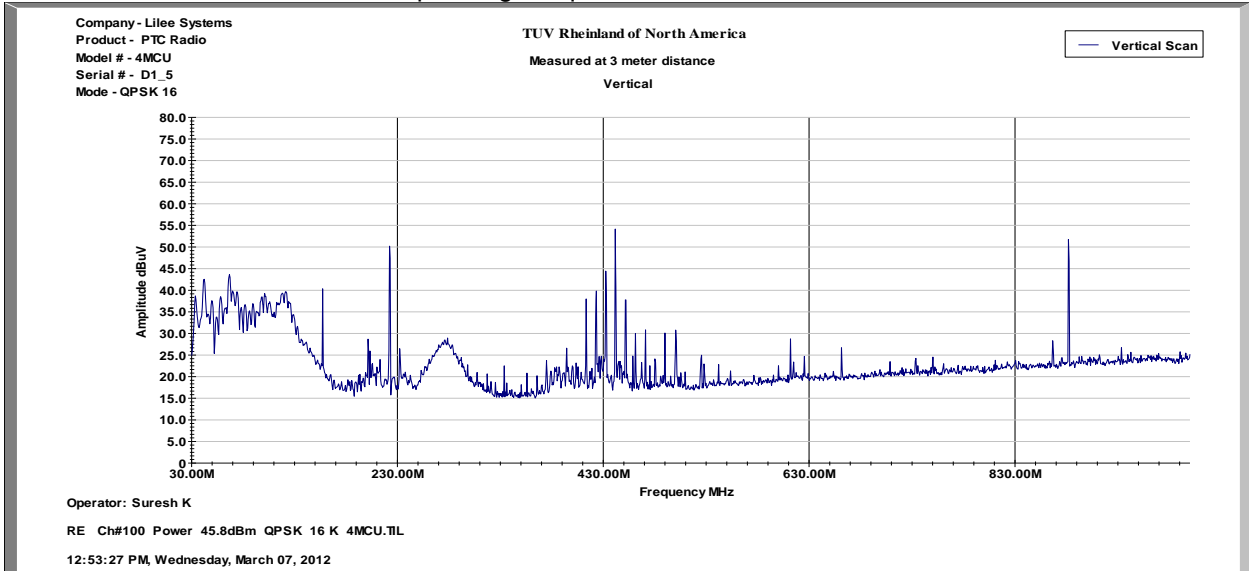

Notes: EUT was

SOP 1 Radiated Emissions						Tracking # 31260509.001 Page 11 of 15				
EUT Name		TransAir PTC-3000				Date		March 7, 2012		
EUT Model		PTC-3000 RF				Temp / Hum in		23°C / 39%rh		
EUT Serial		D1-5 (host)				Temp / Hum out		N/A		
EUT Config.		TX inside Host				Line AC / Freq		12 Vdc		
Standard		CFR47 Part 15 Subpart C				RBW / VBW		120/300 kHz		
Dist/Ant Used		3m / EMCO3115 / 1m - RA42-K-F-4B-C				Performed by		Suresh Kondapalli		
Frequency Peak	Gen	Cable Loss	Antenna Gain	EIRP	Antenna	Table	Height	Limit	Margin	
MHz	dBuV/m	dBm	dB	dbi	dBm	POL	deg	cm	dBm	dB
Transmitted Data 220.4875 16QPSK										
42.25	58.00	-31.91	0.98	-8.90	-41.79	V	0	100	-25	-16.79
66.75	62.10	-32.48	1.17	-1.02	-34.67	V	204	150	-25	-9.67
66.75	51.97	-44.15	1.17	-1.50	-46.82	H	262	200	-25	-21.82
122.00	49.24	-47.45	1.51	-2.06	-51.02	H	88	200	-25	-26.02
199.90	47.76	-54.83	1.89	3.21	-53.50	H	88	149	-25	-28.50
413.42	46.55	-55.25	2.65	6.23	-51.67	V	164	100	-25	-26.67
423.00	49.86	-54.62	2.68	5.90	-51.39	H	164	100	-25	-26.39
432.02	57.24	-47.28	2.71	6.04	-43.95	H	164	100	-25	-18.95
441.00	68.01	-36.53	2.73	6.20	-33.05	H	164	100	-25	-8.05
441.60	62.40	-39.42	2.73	6.50	-35.65	V	164	100	-25	-10.65
452.00	50.50	-53.89	2.77	6.26	-50.39	H	164	100	-25	-25.39
881.98	54.30	-47.02	3.90	7.00	-43.93	V	215	100	-25	-18.93
882.60	53.10	-51.10	3.91	6.65	-48.35	H	215	100	-25	-23.35
Spec Margin = E-Field QP - Limit, E-Field QP = FIM QP+ Total CF ± Uncertainty										
Total CF= Amp Gain + Cable Loss + ANT Factor										
Combined Standard Uncertainty $u_c(y) = \pm 3.2$ dB Expanded Uncertainty $U = ku_c(y)$ $k = 2$ for 95% confidence										
Notes EUT is Class A device										

SOP 1 Radiated Emissions

Tracking # 31260509.001 Page 12 of 15

EUT Name	TransAir PTC-3000	Date	March 07, 2012
EUT Model	PTC-3000 RF	Temp / Hum in	23°C / 40%rh
EUT Serial	D1-5 Host	Temp / Hum out	N/A
EUT Config.	TX module inside Host	Line AC	12 Vdc
Standard	CFR47 Part 15 Part90	RBW / VBW	120/300 kHz
Dist/Ant Used	3m - EMCO3115 / 1m - RA42-K-F-4B-C	Performed by	Suresh Kondapalli

Operating Freq 220.4875MHz 32QPSK

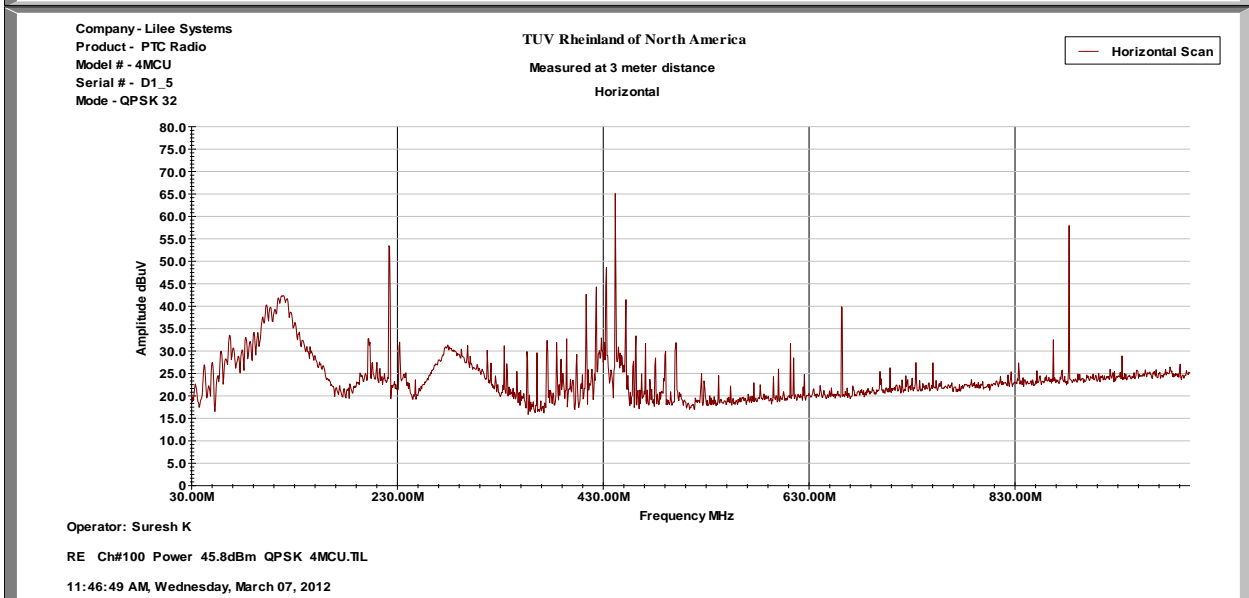
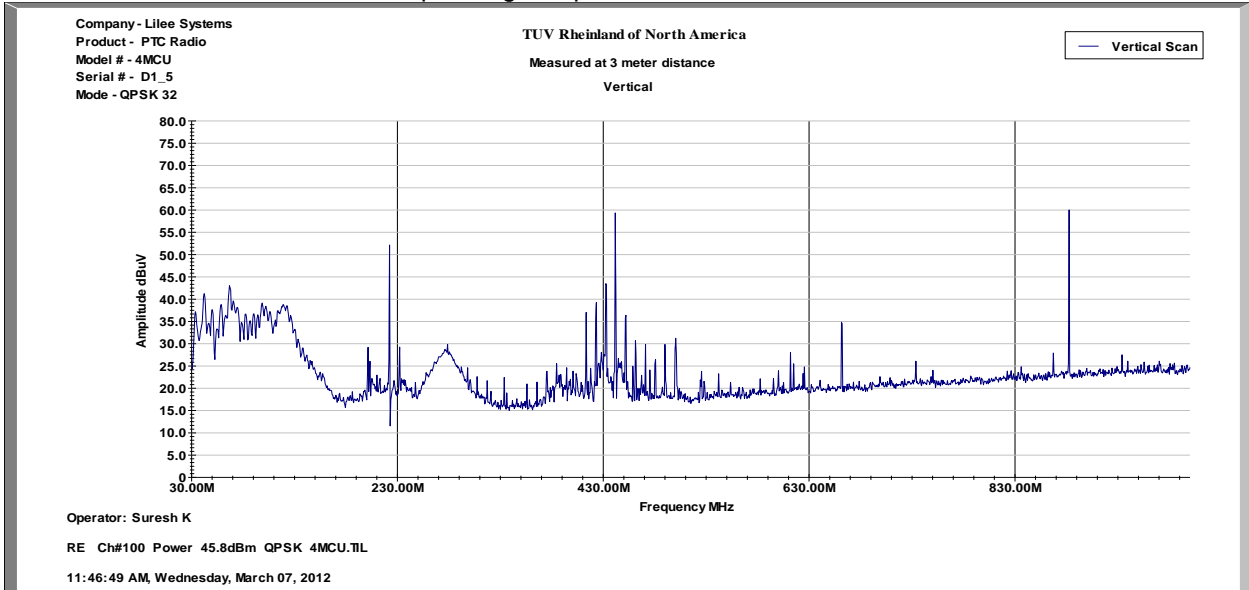

Notes:

SOP 1 Radiated Emissions						Tracking # 31260509.001 Page 13 of 15				
EUT Name		TransAir PTC-3000				Date		March 7, 2012		
EUT Model		PTC-3000 RF				Temp / Hum in		23°C / 39%rh		
EUT Serial		D1-5 (Host)				Temp / Hum out		N/A		
EUT Config.		TX in host device				Line AC / Freq		120Vac/60Hz		
Standard		CFR47 Part 15 Subpart C				RBW / VBW		120 kHz/ 300 KHz		
Dist/Ant Used		3m / EMCO3115 / 1m - RA42-K-F-4B-C				Performed by		Suresh Kondapalli		
Frequency Peak	Gen	Cable Loss	Antenna Gain	EIRP	Antenna	Table	Height	Limit	Margin	
MHz	dBuV/m	dBm	dB	dbi	dBm	POL	deg	cm	dBm	dB
Transmitted Data 220.4875 32QPSK										
42.20	57.90	-31.95	0.98	-8.94	-41.88	V	88	100	-25	-16.88
66.75	62.06	-32.52	1.17	-1.02	-34.71	V	204	100	-25	-9.71
118.81	54.75	-42.35	1.50	-2.10	-45.94	H	88	200	-25	-20.94
413.43	52.60	-51.97	2.65	5.90	-48.72	H	154	100	-25	-23.72
422.40	54.01	-50.46	2.67	5.90	-47.24	H	154	100	-25	-22.24
432.00	56.90	-47.62	2.71	6.04	-44.29	H	154	100	-25	-19.29
440.99	67.30	-34.52	2.73	6.50	-30.75	V	154	150	-25	-5.75
441.00	73.12	-31.42	2.73	6.20	-27.94	H	154	100	-25	-2.94
451.20	49.36	-54.99	2.76	6.28	-51.47	H	154	100	-25	-26.47
661.48	44.70	-59.64	3.35	6.60	-56.39	H	198	200	-25	-31.39
881.90	63.10	-41.08	3.90	6.64	-38.35	H	215	100	-25	-13.35
881.99	60.02	-41.30	3.91	7.00	-38.21	V	100	150	-25	-13.21
Spec Margin = E-Field QP - Limit, E-Field QP = FIM QP+ Total CF ± Uncertainty										
Total CF= Amp Gain + Cable Loss + ANT Factor										
Combined Standard Uncertainty $u_c(y) = \pm 3.2$ dB Expanded Uncertainty $U = k u_c(y)$ $k = 2$ for 95% confidence										
Notes EUT is Class A device										

SOP 1 Radiated Emissions

Tracking # 31260509.001 Page 14 of 15

EUT Name	TransAir PTC-3000	Date	March 07, 2012
EUT Model	PTC-3000 RF	Temp / Hum in	23°C / 40%rh
EUT Serial	D1-5 (Host device)	Temp / Hum out	N/A
EUT Config.	16QPSk max power	Line AC	12 Vdc
Standard	CFR47 Part 15 Subpart C	RBW / VBW	120/300 kHz
Dist/Ant Used	3m - EMCO3115 / 1m - RA42-K-F-4B-C	Performed by	Suresh Kondapalli

TX ON 222 MHz GMSK/16QPSK/32QPSK

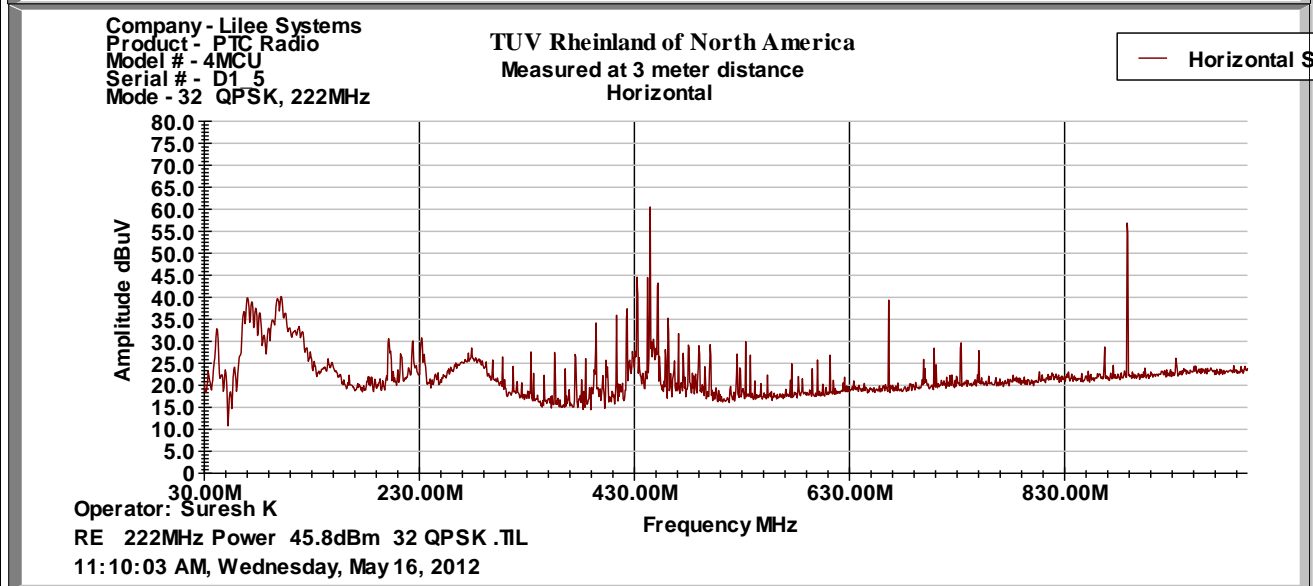
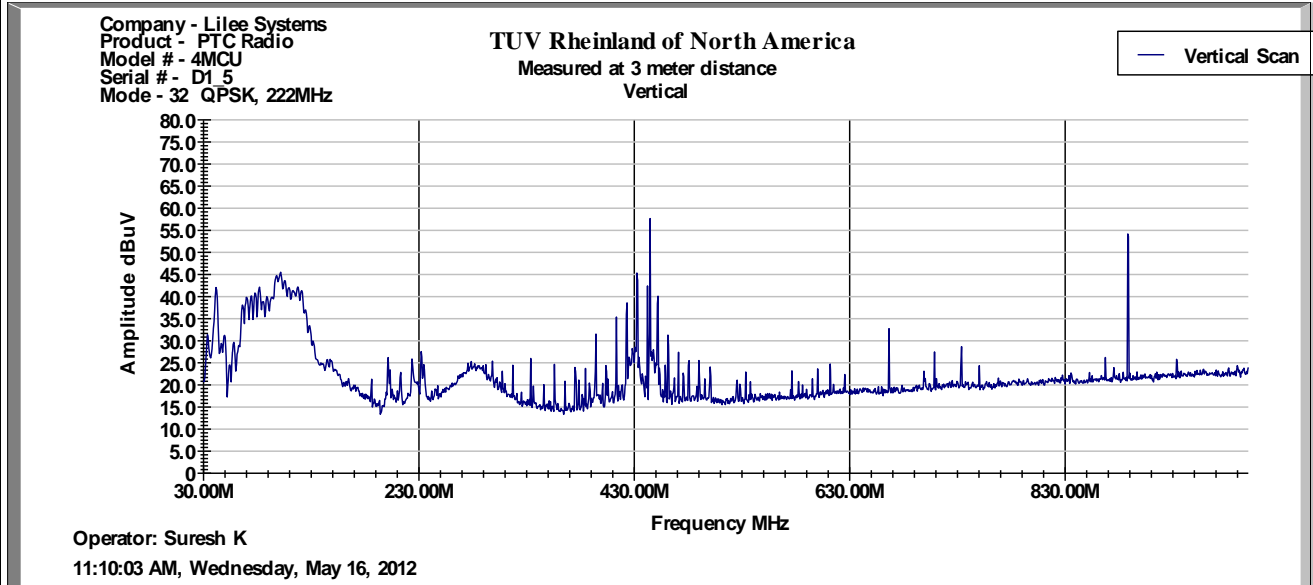

Notes:

SOP 1 Radiated Emissions						Tracking # 31260509.001 Page 15 of 15				
EUT Name	TransAir-PTC 3000					Date	March 7, 2012			
EUT Model	PTC-3000 RF					Temp / Hum in	23°C / 39%rh			
EUT Serial	D1-5					Temp / Hum out	N/A			
EUT Config.	TX ON inside host device					Line AC / Freq	12 Vdc			
Standard	CFR47 Part 15 Subpart C					RBW / VBW	120/300 kHz			
Dist/Ant Used	3m / EMCO3115 / 1m - RA42-K-F-4B-C					Performed by	Suresh Kondapalli			
Frequency Peak	Gen	Cable Loss	Antenna Gain	EIRP	Antenna	Table	Height	Limit	Margin	
MHz	dBuV/m	dBm	dB	dbi	dBm	POL	deg	cm	dBm	dB
Transmitted Data 222 MHz GMSK/16QPSK/32QPSK										
69.43	58.04	-37.70	1.19	-1.36	-40.24	H	285	203	-25	-15.24
76.78	56.44	-41.17	1.25	-0.42	-42.84	H	260	240	-25	-17.84
100.80	59.41	-33.57	1.39	-0.64	-35.6	V	25	110	-25	-10.6
431.99	53.90	-47.70	2.71	6.5	-43.91	V	89	110	-25	-18.91
443.99	67.56	-34.38	2.73	6.5	-30.62	V	334	110	-25	-5.62
444.00	67.52	-36.94	2.73	6.2	-33.48	H	339	104	-25	-8.48
665.99	42.04	-60.09	3.36	7.02	-56.44	V	9	110	-25	-31.44
887.98	57.30	-44.07	3.91	7.0	-40.97	V	82	127	-25	-15.97
887.99	57	-47.3	3.91	6.76	-44.45	H	111	195	-25	-19.45
Spec Margin = E-Field QP - Limit, E-Field QP = FIM QP+ Total CF ± Uncertainty										
Total CF= Amp Gain + Cable Loss + ANT Factor										
Combined Standard Uncertainty $u_c(y) = \pm 3.2$ dB Expanded Uncertainty $U = ku_c(y)$ $k = 2$ for 95% confidence										
Notes EUT is Class A device Table combines all data rates/modulations GMSK/16QPSK/32 QPSK										

4.5.4 Sample Calculation

The field strength is calculated by subtracting the Amplifier Gain and adding the Cable Loss and Antenna Correction Factor to the measured reading. The basic equation is as follows:

$$\text{Field Strength (dB}\mu\text{V/m)} = \text{FIM} - \text{AMP} + \text{CBL} + \text{ACF}$$

Where: FIM = Field Intensity Meter (dBμV)
 AMP = Amplifier Gain (dB)
 CBL = Cable Loss (dB)
 ACF = Antenna Correction Factor (dB/m)

$$\mu\text{V/m} = 10^{\frac{\text{dB}\mu\text{V} / \text{m}}{20}}$$

4.6 Receiver Spurious Emissions

Receiver spurious emissions are emissions at any frequency when the equipment is in receive mode.

The spurious emissions of the receiver shall not exceed the values in CFR47 Part 15.109 and RSS GEN Sect 6.1.

4.6.1 Test Methodology

4.6.1.1 Preliminary Test

A test program that controls instrumentation and data logging was used to automate the preliminary RF emission test procedure. The frequency range of interest was divided into sub-ranges to yield a frequency resolution of approximately 120 kHz and provide a reading at each frequency for no more than 12° of turntable rotation. For each frequency sub-range the turntable was rotated 360° while peak emission data was recorded and plotted over the frequency range of interest in horizontal and vertical antenna polarization's.

Preliminary emission profile testing was performed inside the anechoic chamber. The EUT was placed on a 1.0m x 1.5m non-conductive table 80cm above the floor. The EUT was positioned as shown in the setup photographs. The receiving antenna was placed at a distance of 3m at a fixed height of 1m. Measurement equipment was located outside of the chamber. A video camera was placed inside the chamber to view the EUT.

4.6.1.2 Final Test

For each frequency measured, the peak emission was maximized by manipulating the receiving antenna from 1 to 4 meters above the ground plane and placing it at the position that produced the maximum signal strength reading. The turntable was then rotated through 360° while observing the peak signal and placing the EUT at the position that produced maximum radiation. The six highest emissions relative to the limit were measured unless such emissions were more than 20 dB below the limit. If less than six emissions are within 20 dB of the limit, than the noise level of the receiver is measured at frequencies where emissions are expected. Multiples of all oscillator and microprocessor frequencies were also checked.

Final testing was performed on an NSA compliant test site. The EUT was placed on a 1.0m x 1.5m non-conductive table 80cm above the ground plane. The placement of EUT and cables were the same as for preliminary testing and is shown in the setup photographs.

4.6.1.3 Deviations

None.

4.6.2 Receiver Spurious Emission Limit

The spurious emissions of the receiver shall not exceed the values in CFR47 Part 80 & 90 and RSS 119.

Frequency (MHz)	Field strength (microvolts/meter)	Measurement distance (meters)
0.009-0.490.....	2400/F (kHz)	300
0.490-1.705.....	24000/F (kHz)	30
1.705-30.0.....	30	30
30-88.....	100 **	3
88-216.....	150 **	3
216-960.....	200 **	3
Above 960.....	500	3

4.6.3 Test Results

The final measurement data indicates the worst case operating modes, configurations, and/or cable positions. It also reflects the results including any modifications and/or special accessories listed in Sections 1.4 and 1.5.

As originally tested, the EUT was found to be compliant to the requirements of the test standard(s).

4.6.3.1 Final Data

The data recorded in this section contains the final results under the worst-case conditions and without any modifications or special accessories implemented as the manufacturer intends.

SOP 1 Radiated Emissions						Tracking # 31260509.001 Page 1 of 3				
EUT Name		TransAir PTC-3000				Date		March 07, 2012		
EUT Model		PTC-3000 RF				Temp / Hum in		23°C / 39%rh		
EUT Serial		D1-2				Temp / Hum out		N/A		
EUT Config.		Receive Mode in host device				Line AC / Freq		12 Vdc		
Standard		CFR 47 part 90				RBW / VBW		120/300 kHz		
Dist/Ant Used		3m / EMCO3115 / 1m - RA42-K-F-4B-C				Performed by		Suresh Kondapalli		
Emission Freq	FIM Pk	FIM QP	Total CF	E-Field QP	Spec Limit	Spec Margin	Table Pos	ANT Pos	ANT Pola	Type
120.40	50.41	48.67	-11.85	36.82	43.52	-6.70	267	181	H	Spurious
220.80	53.47	53.40	-13.73	39.67	46.02	-6.35	272	127	H	Spurious
230.40	52.34	51.03	-12.97	38.06	46.02	-7.96	269	125	H	Spurious
431.75	24.47	46.10	-8.08	38.02	46.02	-8.00	205	289	H	Spurious
441.60	49.08	49.12	-8.15	40.97	46.02	-5.05	183	102	H	Spurious
451.19	49.82	50.04	-8.06	41.98	46.02	-4.04	123	222	H	Spurious
65.41	58.01	55.19	-18.55	36.64	40.00	-3.36	143	120	V	Spurious
121.95	45.92	44.25	-11.93	32.32	43.52	-11.20	30	160	V	Spurious
431.75	23.00	43.06	-8.42	34.64	46.02	-11.38	238	132	V	Spurious
441.34	23.85	45.83	-8.45	37.38	46.02	-8.64	194	164	V	Spurious
Spec Margin = E-Field QP - Limit, E-Field QP = FIM QP+ Total CF ± Uncertainty										
Total CF= Amp Gain + Cable Loss + ANT Factor										
Combined Standard Uncertainty $u_c(y) = \pm 3.2$ dB Expanded Uncertainty $U = ku_c(y)$ $k = 2$ for 95% confidence										
Notes:										
Notes: 1Ghz: RBW=120 kHz,VBW=300 kHz 1GHz – 25 GHz: RBW=1MHz, VBW=3MHz										

SOP 1 Radiated Emissions

Tracking # 31260509.001 Page 2 of 3

EUT Name	TransAir PTC-3000	Date	March 7, 2012
EUT Model	PTC-3000 RF	Temp / Hum in	22°C / 40%rh
EUT Serial	D1-2	Temp / Hum out	N/A
EUT Config.	EUT on with all antennas and I/O ports active	Line AC / Freq	12 Vdc
Standard	CFR47 Part 15.109, Class A	RBW / VBW	See Note
Dist/Ant Used	3m / JB3 & EMCO3115	Performed by	Suresh Kondapalli

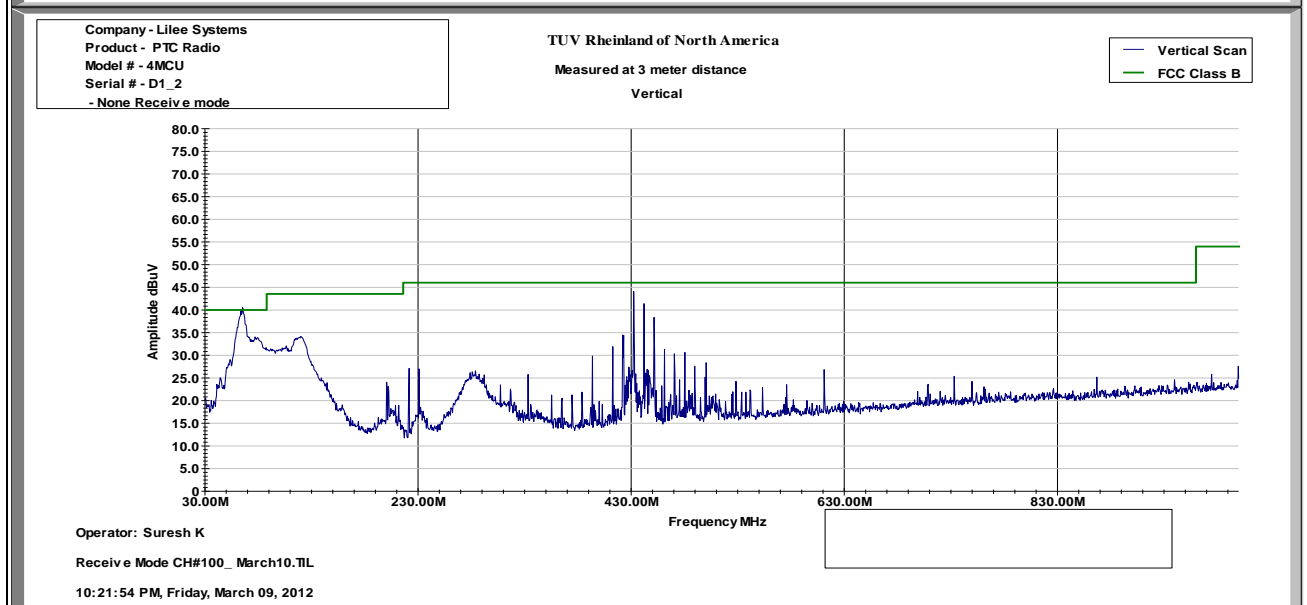
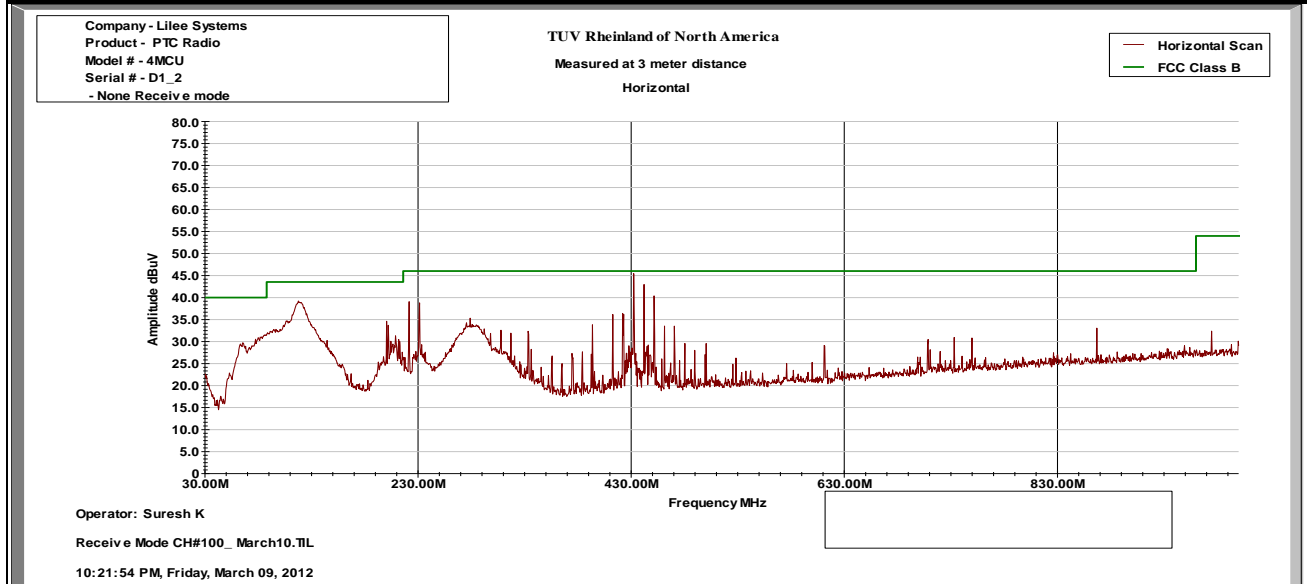

Notes : None

SOP 1 Radiated Emissions		Tracking # 31260509.00 Page 3 of 3 12	
EUT Name	TransAir PTC-3000	Date	03/08/2012
EUT Model	PTC-3000 RF	Temp / Hum in	22°C / 40%rh
EUT Serial	D1-2	Temp / Hum out	N/A
EUT Config.	Receive Mode	Line AC	12 Vdc
Standard	CFR 47 part 90	RBW / VBW	1MHz/3MHz
Dist/Ant Used	3m / JB3	Performed by	Suresh Kondapali

Above 1GHz Plot for Receive Mode

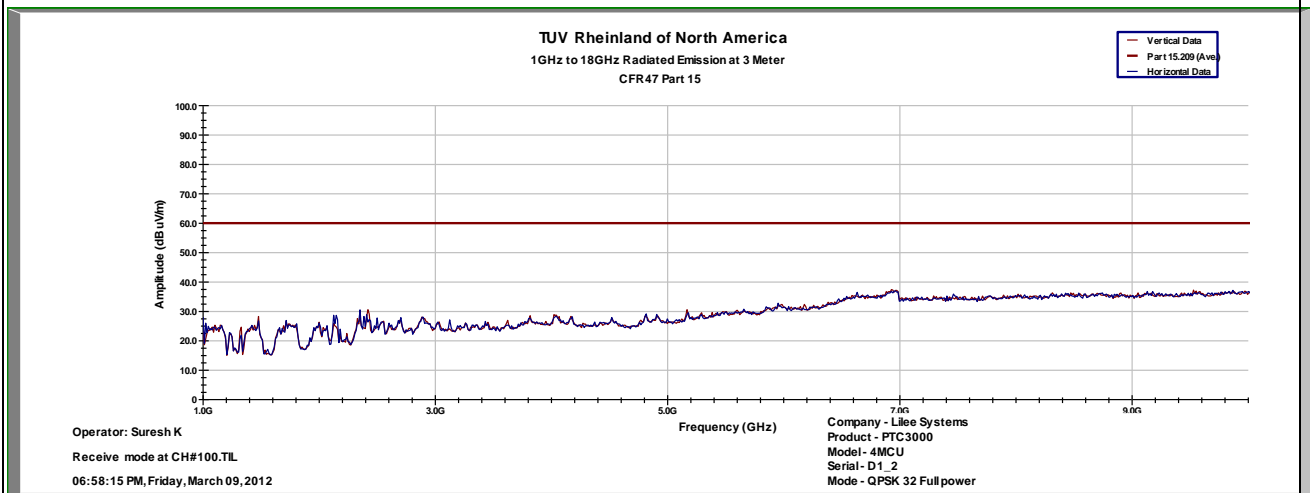

Notes: All emission above 18GHz are atleast 20 dB below the limit

4.6.4 Sample Calculation

The field strength is calculated by subtracting the Amplifier Gain and adding the Cable Loss and Antenna Correction Factor to the measured reading. The basic equation is as follows:

$$\text{Field Strength (dB}\mu\text{V/m)} = \text{FIM} - \text{AMP} + \text{CBL} + \text{ACF}$$

Where: FIM = Field Intensity Meter (dB μ V)
 AMP = Amplifier Gain (dB)
 CBL = Cable Loss (dB)
 ACF = Antenna Correction Factor (dB/m)

$$\mu\text{V/m} = 10^{\frac{\text{dB}\mu\text{V} / \text{m}}{20}}$$

4.7 Frequency Stability

In accordance with 47 CFR Part 90.213(a) the transmitters used in the services governed by this part must have a minimum frequency stability specified below

Frequency range (MHz)	Fixed and base stations	Mobile stations	
		Over 2 watts output power	2 watts or less output power
216–220	1.0		1.0
220–222 ¹²	0.1	1.5	1.5

¹²Mobile units may utilize synchronizing signals from associated base stations to achieve the specified carrier stability.

4.7.1 Test Methodology

FCC 2.1055

EUT was placed inside temperature chamber and its power supply was connected to variable DC power supply. Antenna port was connected to spectrum Analyzer placed outside the chamber. The frequency stability was measured at the antenna port with a spectrum analyzer using a peak detector with a resolution bandwidth of 3Hz and a video bandwidth of 1 kHz.

For Base station Operating

Measurements were performed at nominal power supply voltage (DC 17 Vdc) with variation of ambient temperature from -30 to +50° C with 10° C steps and at nominal temperature (20° C) with variation of power supply voltage from 85% to 115% of the nominal value. For each test condition, after stable temperature was reached, the EUT was turned on and the operating frequency was measured at startup and at 2, 5 and 10 minutes after the EUT was energized. The EUT was transmitting an unmodulated carrier for this test.

Frequency stability test were performed at 220.0125MHz and 220.9875MHz. The test is applicable for entire range of 216 to 222MHz as equipment same firmware for entire range.

4.7.2 Test results

As originally tested, the EUT was found to be compliant to the requirements of the test standard(s).

Table 6: Frequency Stability – Test Results Fixed Mode

Test Conditions		Freq. Assigned MHz	Measured MHz	Dev. Hz	Deviation %	Deviation PPM	Deviation Limit PPM
Temp. [°C]	DC Input [V]						
0	17.0	220.012500	220.012508	8	3.63616E-06	0.03636157	0.1
-10	17.0	220.012500	220.012518	18	8.18135E-06	0.081813533	0.1
-20	17.0	220.012500	220.012522	22	9.99943E-06	0.099994319	0.1
-30	17.0	220.012500	220.012522	22	9.99943E-06	0.099994319	0.1
10	17.0	220.012500	220.012507	7	3.18164E-06	0.031816374	0.1
20	17.0	220.012500	220.012507	7	3.18164E-06	0.031816374	0.1
30	17.0	220.012500	220.012498	-2	-9.09039E-07	-0.009090393	0.1
40	17.0	220.012500	220.012490	-10	-4.5452E-06	-0.045451963	0.1
50	17.0	220.012500	220.012494	-6	-2.72712E-06	-0.027271178	0.1
22	14.4 (85%)	220.012501	220.012501	1	4.5452E-07	0.004545196	0.1
22	19.4 (115%)	220.012501	220.012501	1	4.5452E-07	0.004545196	0.1
22	10 Lowest Operational	220.012501	220.012501	1	4.5452E-07	0.004545196	0.1
22	24 Highest Operational	220.012501	220.012501	1	4.5452E-07	0.004545196	0.1

Frequency evaluation was made at the start time, 2 min, 5 min and 10 min from start time with worst-case values reported here.

Table 7: Frequency Stability – Test Results Fixed Mode

Test Conditions		Freq Assigned MHz	Measured MHz	Dev. Hz	Deviation %	Deviation PPM	Deviation Limit PPM
Temp. [°C]	DC Input [V]						
0	17.0	220.987500	220.987510	10	4.52514E-06	0.045251428	0.1
-10	17.0	220.987500	220.987517	17	7.69274E-06	0.076927428	0.1
-20	17.0	220.987500	220.987521	21	9.5028E-06	0.095027999	0.1
-30	17.0	220.987500	220.987522	22	9.95531E-06	0.099553142	0.1
10	17.0	220.987500	220.987508	8	3.62011E-06	0.036201143	0.1
20	17.0	220.987500	220.987505	5	2.26257E-06	0.022625714	0.1
30	17.0	220.987500	220.987499	-1	-4.52514E-07	-0.004525143	0.1
40	17.0	220.987500	220.987489	-11	-4.97766E-06	-0.049776571	0.1
50	17.0	220.987500	220.987493	-7	-3.1676E-06	-0.031676000	0.1
22	14.4 (85%)	220.987500	220.987503	3	1.35754E-06	0.013575428	0.1
22	19.4 (115%)	220.987500	220.987502	2	9.05029E-07	0.009050286	0.1
22	10 Lowest Operational	220.987500	220.987502	2	9.05029E-07	0.009050286	0.1
22	24 Highest Operational	220.987500	220.987498	-2	-9.05029E-07	-0.009050286	0.1

Frequency evaluation was made at the start time, 2 min, 5 min and 10 min from start time with worst-case values reported here.

Table 8: Frequency Stability – Test Results Mobile station mode

Test Conditions		Freq. Assigned MHz	Measured MHz	Dev. Hz	Deviation %	Deviation PPM	Deviation Limit PPM
Temp. [°C]	DC Input [V]						
0	17	220.012500	220.012551	51	2.31805E-05	0.231805	+/-1.5
-10	17	220.012500	220.012570	70	3.18164E-05	0.3181637	+/-1.5
-20	17	220.012500	220.012555	55	2.49986E-05	0.2499858	+/-1.5
-30	17	220.012500	220.012550	50	2.2726E-05	0.2272598	+/-1.5
10	17	220.012500	220.012607	107	4.86336E-05	0.486336	+/-1.5
20	17	220.012500	220.012619	119	5.40878E-05	0.5408784	+/-1.5
30	17	220.012500	220.012630	130	5.90876E-05	0.5908755	+/-1.5
40	17	220.012500	220.012637	137	6.22692E-05	0.6226919	+/-1.5
50	17	220.012500	220.012644	144	6.54508E-05	0.6545083	+/-1.5
22	14.4 (85%)	220.012500	220.012626	126	5.72695E-05	0.5726947	+/-1.5
22	19.4 (115%)	220.012500	220.012626	126	5.72695E-05	0.5726947	+/-1.5
22	10 Lowest Operational	220.012500	220.012627	127	5.7724E-05	0.5772399	+/-1.5
22	24 Highest Operational	220.012500	220.012624	124	5.63604E-05	0.5636043	+/-1.5

Frequency evaluation was made at the start time, 2 min, 5 min and 10 min from start time with worst-case values reported here.

Table 9: Frequency Stability – Test Results mobile Station mode

Test Conditions		Freq. Assigned MHz	Measured MHz	Dev. Hz	Deviation %	Deviation PPM	Deviation Limit PPM
Temp. [°C]	DC Input [V]						
0	17	220.987500	220.987600	100	4.52514E-05	0.452514282	+/-1.5
-10	17	220.987500	220.987578	78	3.52961E-05	0.35296114	+/-1.5
-20	17	220.987500	220.987578	78	3.52961E-05	0.35296114	+/-1.5
-30	17	220.987500	220.987559	59	2.66983E-05	0.266983427	+/-1.5
10	17	220.987500	220.987610	110	4.97766E-05	0.497765711	+/-1.5
20	17	220.987500	220.987650	150	6.78771E-05	0.678771424	+/-1.5
30	17	220.987500	220.987652	152	6.87822E-05	0.687821709	+/-1.5
40	17	220.987500	220.987653	153	6.92347E-05	0.692346852	+/-1.5
50	17	220.987500	220.987654	154	6.96872E-05	0.696871995	+/-1.5
22	14.4 (85%)	220.987500	220.987651	151	6.83297E-05	0.683296567	+/-1.5
22	19.4 (115%)	220.987500	220.987651	151	6.83297E-05	0.683296567	+/-1.5
22	10 Lowest Operational	220.987500	220.987651	151	6.83297E-05	0.683296567	+/-1.5
22	24 Highest Operational	220.987500	220.987651	151	6.83297E-05	0.683296567	+/-1.5

Frequency evaluation was made at the start time, 2 min, 5 min and 10 min from start time with worst-case values reported here.

Test Setup Photos

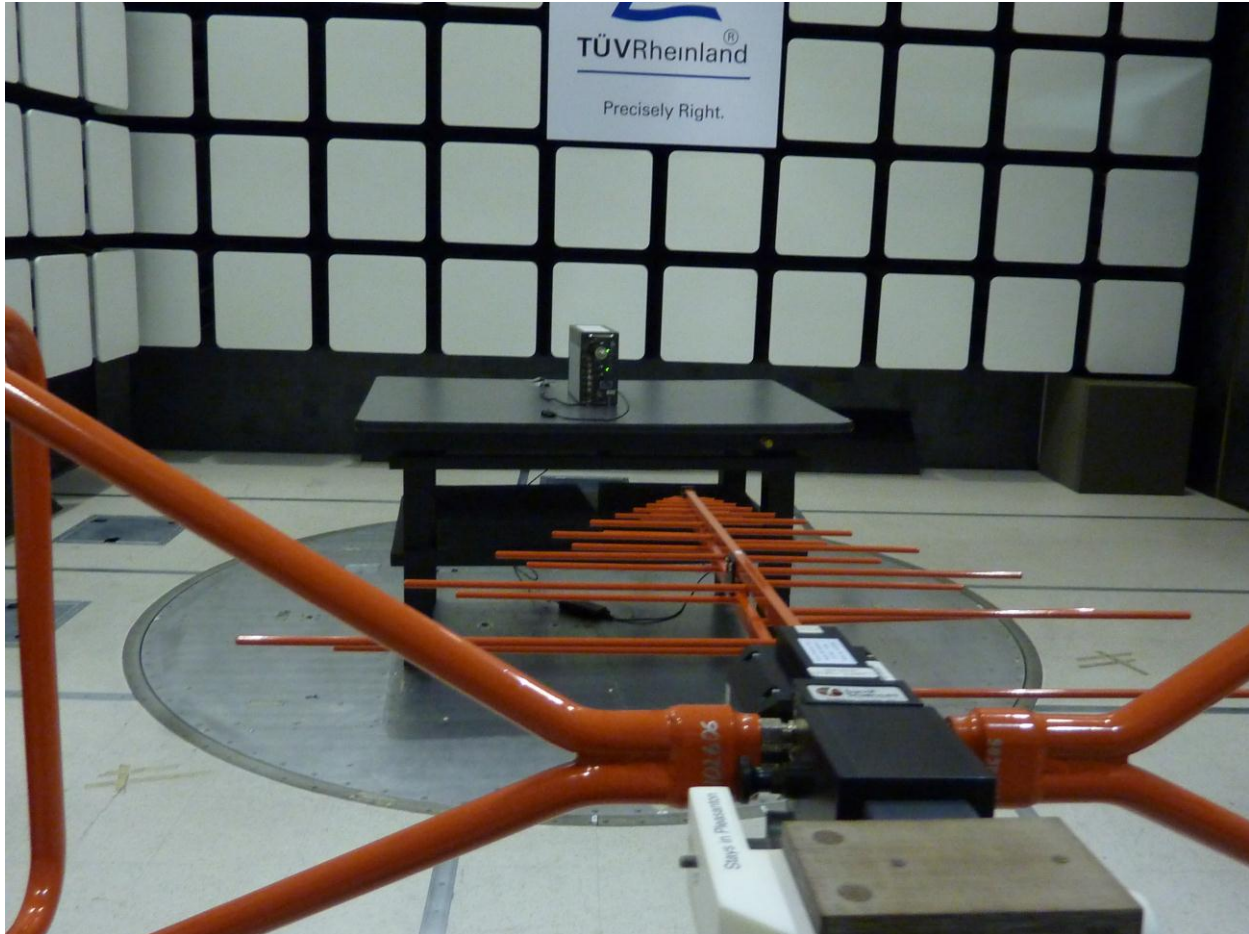

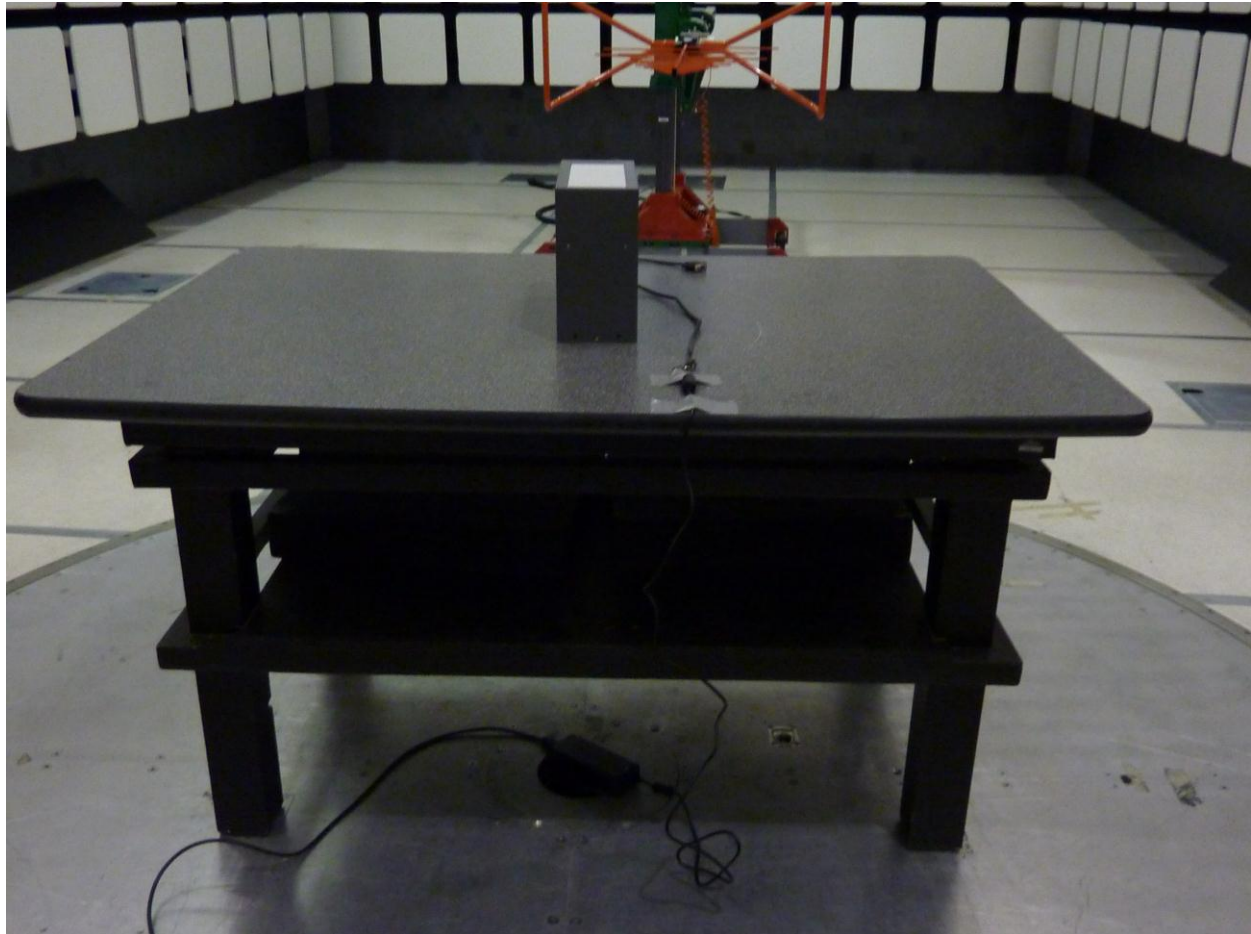

5 Test Equipment Use List

5.1 Equipment List

Equipment	Manufacturer	Model #	Serial/Inst #	Last Cal dd/mm/yy	Next Cal dd/mm/yy
Bilog Antenna	Sunol Sciences	JB3	A102606	5/19/2012	5/19/2013
Horn Antenna	Sunol Sciences	DRH-118	A040806	9/29/2010	9/29/2012
Antenna (18-26GHz)	CMT	RA42-K-F-4B-C	020131-004	1/17/2012	1/17/2013
Antenna (26-40GHz)	CMT	RA28-K-F-4B-C	011469R-003	1/17/2012	1/17/2013
EMI Receiver	Hewlett Packard	8546A	3807A00445	1/17/2012	1/17/2013
Preselector	Hewlett Packard	85460A	3704A00407	1/17/2012	1/17/2013
Amplifier	Hewlett Packard	8447D	2944A07996	1/16/2012	1/16/2013
Spectrum Analyzer	Rhode & Schwarz	ESIB	832427/002	1/17/2012	1/17/2013
Amplifier	Rhode & Schwarz	TS-PR18	3545.7008.03	9/29/2010	9/29/2012
Amplifier	Rhode & Schwarz	TS-PR26	100011	1/16/2012	1/16/2013
Amplifier	Rhode & Schwarz	TS-PR40	100012	1/16/2012	1/16/2013
Signal Generator	Anritsu	MG3694A	42803	1/17/2012	1/17/2013
Notch Filter	Micro-Tronics	BRM50702	37	1/17/2012	1/17/2013
Notch Filter	Micro-Tronics	BRC50705	9	1/17/2012	1/17/2013
High Pass Filter (3.5 GHz)	Hewlett Packard	84300-80038	820004	1/17/2012	1/17/2013
High Pass Filter (8.5 GHz)	Micro-Tronics	HPM50107	4	1/17/2012	1/17/2013
Notch Filter	Telonic Berkely, Inc	TTR190-3EE	50033-2	VB	VB
Power Supplier	Kikosui	PCR8000W	CM000912	1/19/2012	1/19/2013
Digital Multimeter	Fluke	177	92780314	1/18/2012	1/18/2013
Power Meter	Agilent	E4418B	MY45103902	1/19/2012	1/19/2013
Power Sensor	Hewlett Packard	8482A	55-5131	1/19/2012	1/19/2013
Spectrum Analyzer	Agilent	E4407B	SG43330468	10/05/2011	10/05/2012

VB: Verify before use

6 EMC Test Plan

6.1.1 Introduction

This section provides a description of the Equipment Under Test (EUT), configurations, operating conditions, and performance acceptance criteria. It is an overview of information provided by the manufacturer so that the test laboratory may perform the requested testing.

6.1.2 Customer

Table 10: Customer Information

Company Name	Lilee Systems, Ltd
Address	2905 Stender Way, Suite 78
City, State, Zip	Santa Clara, CA 95054
Country	U.S.A.
Phone	(408) 988-8672
Fax	(408) 988-8813

Table 11: Technical Contact Information

Name	Hamid Movahedi
E-mail	hmovahedi@lileesystems.com
Phone	(408) 898-8672
Fax	(408) 988-8813

6.1.3 Equipment Under Test (EUT)

Table 12: EUT Specifications

EUT Specification	
Dimensions	Lenth:17cm with PA (14.5cm without PA) Width: 10cm (w). The board is 62mil thick, but the PA height is 1cm.
AC Adapter (For charging only)	Input Voltage: 10 to 24 Vdc Input Current: 12 A
Environment	Mobile/Fixed
Operating Temperature Range:	-40 to +70 degrees C
Multiple Feeds	<input type="checkbox"/> Yes and how many <input checked="" type="checkbox"/> No
Hardware Version	D
Part Number	None
RF Software Version	None
Radio Module	
Operating Mode	Used in PTC-3000 family radios
Transmitter Frequency Band	216 to 222 MHz
Max. Rated Power Output	See Channel Planning Table.
Power Setting @ Operating Channel	Power setting is from Att 31 = 20 dBm to ATT 0= 45.8 dBm See Channel Planning Table.
Antenna Type	TransAir 3 dBi PIFA Antenna for Locomotive /Mobile (actual gain5.2 dBi) TransAir 13 dBi sector Antenna for Base station and wayside YA-200230M13-NF 13 dBi Yagi antenna for Base Station SY2062-SF11SNM(U) Dual Yagi, 12 dBd for Base station (14.1 dBi)
Modulation Type	<input type="checkbox"/> AM <input type="checkbox"/> FM <input type="checkbox"/> DSSS <input type="checkbox"/> OFDM <input checked="" type="checkbox"/> Other describe: GMSK, $\Pi/4$ QPSK, QPSK, OQPSK, BPSK, SOQPSK, & DQPSK,
Data Rate	9600BPS, 16KBPS, 32KBPS
TX/RX Chain (s)	2 (Primary and standby only one active at a time)
Directional Gain Type	<input checked="" type="checkbox"/> Uncorrelated <input checked="" type="checkbox"/> No Beam-Forming <input type="checkbox"/> Other describe:

EUT Specification	
Type of Equipment	<input type="checkbox"/> Table Top <input type="checkbox"/> Wall-mount <input type="checkbox"/> Floor standing cabinet <input checked="" type="checkbox"/> Other Fixed and mobile modes, used in Locomotive, Wayside Station, Fixed mounted/ Base station

Table 13: EUT Channel Power Specifications

Frequency (MHz)	Power Set Value
	See Table 2

EUT channels available;

PTC-3000 RF uses 216 to 222MHz band as follows

RSS 119 para 5.5.3

The 217-218 MHz and 219-220 MHz bands are each segmented into 80 channels, with carrier frequencies evenly spaced at 12.5 kHz, the first and last carrier frequencies being 6.25 kHz from the band edges. **Note:** Equipment may be certified to operate in the entire band 217-220 MHz, but the sub-band 218-219 MHz may not be available for licensing.

PTC-3000 RF Ch#3 to CH# 198

Table B1 - Channel Designations in the Band 220-222 MHz

Note: Only base station frequencies are listed in MHz. Paired mobile station frequencies are 1 MHz higher

Channel Number	Centre Frequency	Channel Number	Centre Frequency	Channel Number	Centre Frequency
1	220.0025	51	220.2525	101	220.5025
2	220.0075	52	220.2575	102	220.5075
3	220.0125	53	220.2625	103	220.5125
4	220.0175	54	220.2675	104	220.5175
5	220.0225	55	220.2725	105	220.5225
6	220.0275	56	220.2775	106	220.5275
7	220.0325	57	220.2825	107	220.5325
8	220.0375	58	220.2875	108	220.5375
9	220.0425	59	220.2925	109	220.5425
10	220.0475	60	220.2975	110	220.5475
11	220.0525	61	220.3025	111 ²	220.5525
12	220.0575	62	220.3075	112	220.5575
13	220.0625	63	220.3125	113 ²	220.5625
14	220.0675	64	220.3175	114	220.5675
15	220.0725	65	220.3225	115 ²	220.5725
16	220.0775	66	220.3275	116	220.5775
17	220.0825	67	220.3325	117 ²	220.5825
18	220.0875	68	220.3375	118	220.5875
19	220.0925	69	220.3425	119 ²	220.5925
20	220.0975	70	220.3475	120	220.5975
21 ¹	220.1025	71	220.3525	121	220.6025
22 ¹	220.1075	72	220.3575	122	220.6075
23 ¹	220.1125	73	220.3625	123	220.6125
24 ¹	220.1175	74	220.3675	124	220.6175
25 ¹	220.1225	75	220.3725	125	220.6225
26	220.1275	76	220.3775	126	220.6275
27	220.1325	77	220.3825	127	220.6325
28	220.1375	78	220.3875	128	220.6375
29	220.1425	79	220.3925	129	220.6425
30	220.1475	80	220.3975	130	220.6475
31	220.1525	81	220.4025	131	220.6525
32	220.1575	82	220.4075	132	220.6575
33	220.1625	83	220.4125	133	220.6625
34	220.1675	84	220.4175	134	220.6675
35	220.1725	85	220.4225	135	220.6725
36	220.1775	86	220.4275	136	220.6775

37	220.1825	87	220.4325	137	220.6825
38	220.1875	88	220.4375	138	220.6875
39	220.1925	89	220.4425	139	220.6925
40	220.1975	90	220.4475	140	220.6975
41	220.2025	91	220.4525	141	220.7025
42	220.2075	92	220.4575	142	220.7075
43	220.2125	93	220.4625	143	220.7125
44	220.2175	94	220.4675	144	220.7175
45	220.2225	95	220.4725	145	220.7225
46	220.2275	96	220.4775	146	220.7275
47	220.2325	97	220.4825	147	220.7325
48	220.2375	98	220.4875	148	220.7375
49	220.2425	99	220.4925	149	220.7425
50	220.2475	100	220.4975	150	220.7475

¹ Available to the Railway Association of Canada (refer to Section 5.5)

² Available to Canada for ITS/IVHS operations on a shared basis within the coordination zone (refer to Section 5.3)

³ Available for public safety and mutual aid operations (refer to Section 5.2.1)

⁴ Available for low-power operations in both countries (refer to Section 5.4)

Table 14: Interface Specifications:

Power Output through custom connector, SPI and control signals

Table 15: Supported Equipment :

4MCU chassis and main control board

Table 16: Description of Sample used for Testing

Device	Serial	RF Connection	CFR47 Part 90
PTC-3000 Transmitter Module	556D904D04G21000005M0LB	N- Female terminated with Load	TX Emission, RX Emission,
		N-Female Connected directly to Spectrum analyzer through short coax cable and Calibrated 30 dB pad	RF Power Output, Out of Band Emission, Emission mask, Occupied Bandwidth Frequency Stability

Table 17: Description of Test Configuration used for Radiated Measurement.

Device	Antenna	Mode	
PTC-3000 Transmitter Module With PTC3004 Chasis	Dummy Load	* Transmit * Receive	EUT is normally rack mounted/ used on table top. EUT was evaluated as table top equipment
Chasis Serial #: D1-5 & D1-2			

6.1.4 Test Specifications

Testing requirements

Table 18: Test Specifications

Emissions and Immunity	
Standard	Requirement
CFR 47 Part 80 & 90	All
RSS 119 Issue 11, 2011	All