

SpiderCloud[®] Radio Node - SCRN-310 Hardware Installation Guide

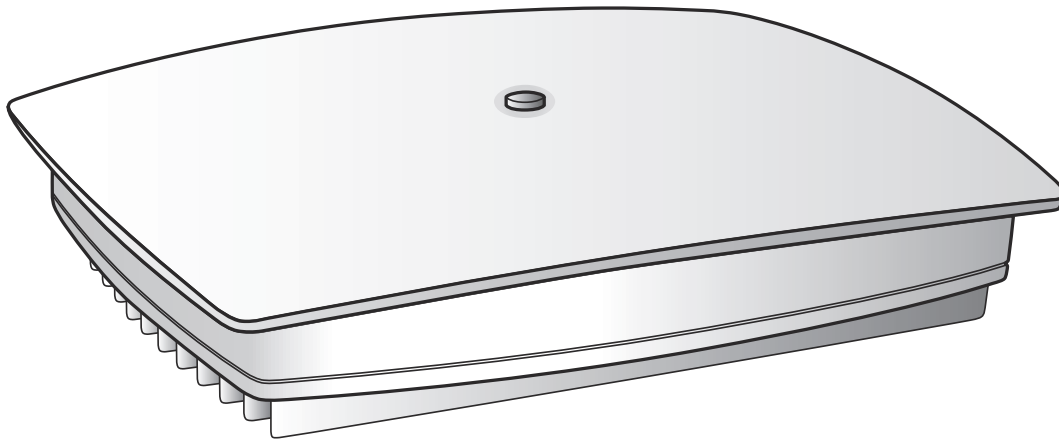

Part number: DOC-SCRN-310-HW-01, Rev. 0.1 DRAFT
Published: February 2014

FCC Statements

Caution: Any changes or modification cautions to this device not explicitly approved by manufacturer could void your authority to operate this equipment.

This equipment complies with FCC radiation exposure limits set forth for an uncontrolled environment. This equipment should be installed and operated with minimum 20 cm between the radiator and your body. This transmitter must not be collocated or operating in conjunction with any other antenna or transmitter unless authorized to do so by the FCC.

Revision History

Revision	Date	Summary of Changes
0.1	2/19/2014	Initial draft document release

Legal Notice

Customer agrees that the Software, including the specific design and structure of individual programs, and the Documentation are protected by United States and foreign copyright and trade secret laws. Customer agrees not to reproduce, disclose, alter, provide or otherwise make available such trade secrets or copyrighted material in any form to any third party without the prior written consent of SpiderCloud Wireless. Customer agrees to implement reasonable security measures to protect such trade secrets and copyrighted material at least to the extent that Customer protects its own information of a similar nature.

The information contained herein is subject to change without notice. Although all information is believed to be accurate at the date of publication, SpiderCloud assumes no responsibility for inaccuracies contained herein.

Copyright © 2014 SpiderCloud Wireless, Inc. SpiderCloud Wireless is a registered trademark and SmartCloud a trademark of SpiderCloud Wireless, Inc. All rights reserved.

SpiderCloud Wireless

408 East Plumeria Drive
San Jose, CA 95134, USA

<http://www.spidercloud.com>

Tel: +1 408 567-9165

Email: info@spidercloud.com

Table of Contents

About this Manual	5
System Overview	5
Radio Node Features	6
Radio Node System Isometric Top View and Bottom View	6
System Specifications	7
Frequency Bands of Operation	7
Size and Dimensions	7
Environmental Requirements	7
Power	8
Compliance	8
Radio Node Models	8
Antennas	9
Ports	9
The Top-Panel LED	9
Input Power	10
Select the Radio Node Location	11
Installation and Mount Bracket Assembly	12
Bracket Mounting and Cabling Guidelines	13
Typical Radio Node Mounting Options	13
Installing the Radio Node	13
Installing the Radio Node (Method 1)	13
Installing the Radio Node (Method 2)	15
Completing the Installation	17
Detaching the Radio Node from the Mount Bracket	17
Boot Sequence and Services Node Communication	18
Radio Node LED Boot Sequence	19
Radio Node LED Management	20
The SpiderCloud Documentation Set	22
Appendix A UMTS Antenna Patterns	23
Appendix B LTE Antenna Patterns	27

Contents

About this Manual

This guide provides the system specifications of the SpiderCloud® Radio Node 310 (SCRN-310). It includes detailed hardware installation instructions, the boot sequence, and expected LED behavior both during the boot-up and under operating conditions. An appendix shows the radio node antenna patterns.

The primary audience for this guide includes network planners, system administrators and installation personnel. It assumes you have knowledge about networking principles, networking configuration, site preparation, powering, and experience in hardware installation and maintenance.

System Overview

The SCRN-310 is an indoor multi-access small cell capable of supporting Universal Mobile Telecommunications System (UMTS) and Long Term Evolution (LTE) radio protocols concurrently in a single platform. The radio node is 3GPP compliant, supporting UMTS Release 7 and LTE Release 9 standards.

Each radio node supports:

- up to 32 simultaneous UMTS voice and data channels, a peak downlink rate of 21 Mbps and a peak uplink rate of 5 Mbps.
- up to 32 active LTE users, a peak download rate of 100 Mbps, and a peak upload of 50 Mbps when used with 20 MHz channel bandwidth.

The radio node enables mobile operators to offer dedicated, in-building coverage and capacity for UMTS and LTE services. It is easy to install and connects to the existing enterprise LAN using standard Ethernet cabling or to a dedicated LAN infrastructure deployed for use by the operator. SCRN-310 radio nodes are managed by the SpiderCloud SCSN-9000 services node access controller, typically installed in the enterprise DMZ.

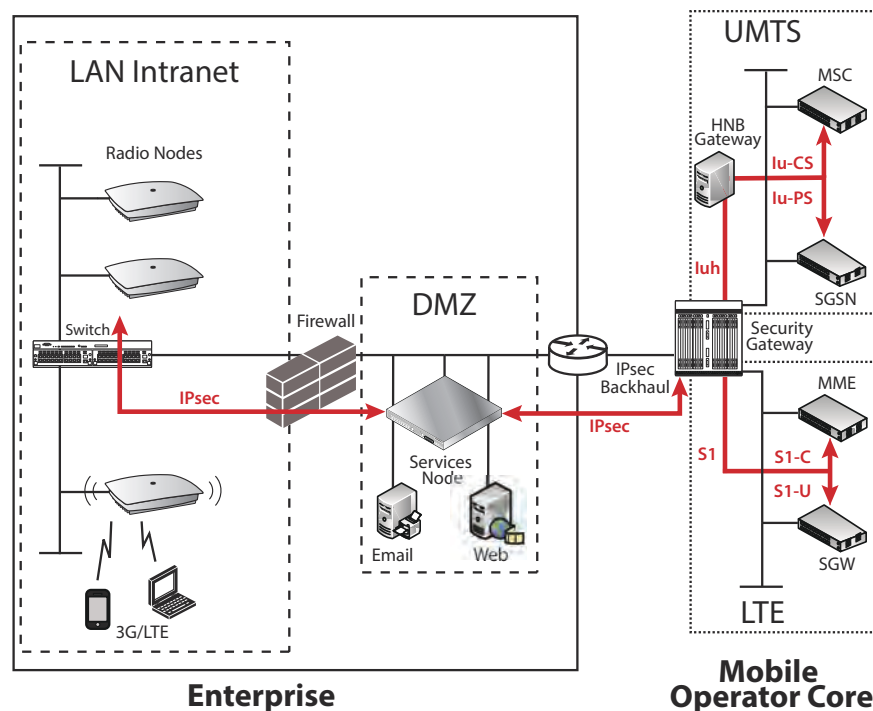

Figure 1 Radio Node Relationship to Enterprise and Mobile Operator Core Networks

Radio Node Features

The radio node supports the following features:

- Complete enterprise mobility using licensed 3G and LTE spectrum
- Self Organizing Network (SON) capabilities for autonomous setup, operation, and management
- Secure boot
- Transparent integration into enterprise network environments
- Certificate-based authentication with the SpiderCloud services node

Radio Node System Isometric Top View and Bottom View

The radio node ships with four internal antennas. The following drawings display an isometric top and bottom views of the radio node:

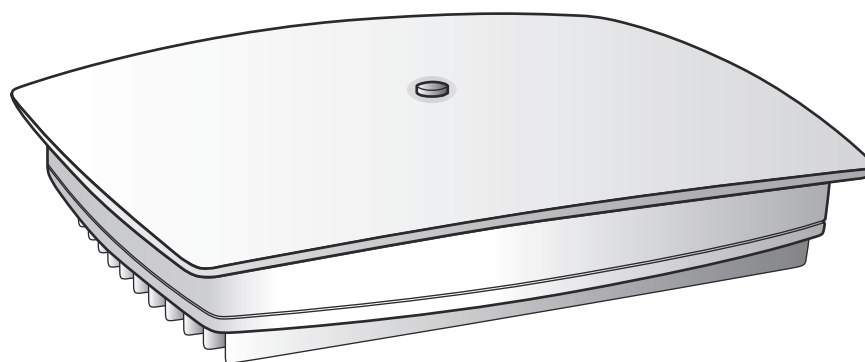

Figure 2 Radio Node Top View

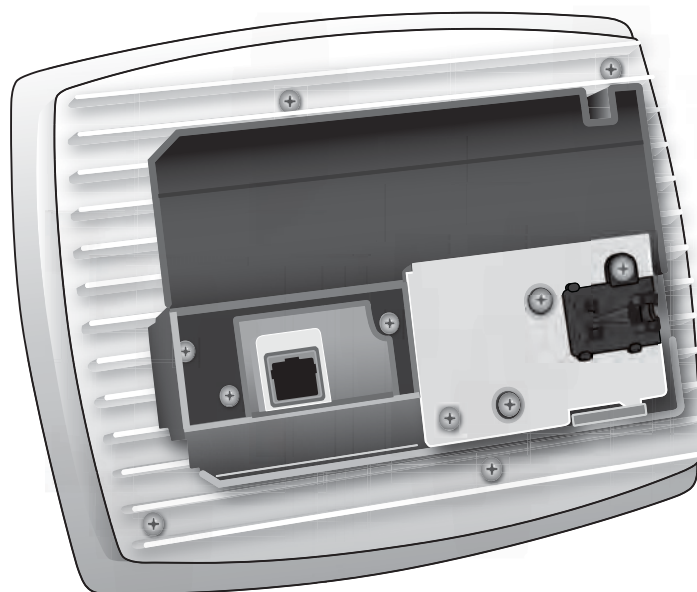

Figure 3 Radio Node Bottom View with Pedestal Base

System Specifications

Following are the system specifications for the radio node frequency bands of operation, system size, environmental requirements, power, and compliance.

Frequency Bands of Operation

SpiderCloud Wireless currently provides two versions of the SCRN-310 for operation in the following UMTS and LTE band combinations. Note that the SCRN-310 hardware is also capable of supporting two carriers of LTE (feature available in a future software upgrade).

- SCRN310-0701
 - Operates in Band Class 1 (UMTS)
 - Operates in Band Class 7 (LTE)
 - Monitors GSM 900/1800 MHz, UMTS 2100/900 MHz, LTE 2600/1800/800 MHz
- SCRN310-0402
 - Operates in Band Class 2 (UMTS)
 - Operates in Band Class 4 (LTE)
 - Monitors GSM 850/1900 MHz, UMTS 2100/1900/850 MHz, LTE 2100/700 MHz

Size and Dimensions

- Height:
 - 5.3 centimeters (2.1 inches)
 - 11.3 centimeters including mount bracket assembly (4.4 inches)
- Width: 20.6 centimeters (8.1 inches)
- Length: 23.9 centimeters (9.4 inches)
- Weight:
 - 1.2 kilograms (2.6 pounds)
 - 1.41 kilograms with mounting bracket (3.1+ pounds)

Environmental Requirements

- Operating temperature range:
 - 0° to 50° C (32° to 122° F) vertical mount
 - 0° to 40° C (32° to 104°F) horizontal mount, fins up
- Operating humidity: 0 to 90% non-condensing
- Storage temperature range: 0° to 85° C (-40° to 185° F)
- Storage humidity: 0 to 90% non-condensing
- Ingress protection rating: IP30

Power

The radio node is compliant with IEEE 802.3at (PoE+):

- Power consumption: 23W maximum
- UMTS transmitter output power: 1x 250 mW (24 dBm) RMS radio power
- LTE transmit output power: 2x125 mW (24 dBm)

Compliance

- ETSI:
 - EN 301 489-1
 - EN 301 489-23
 - EN 301 908-1
 - EN 301 908-3
 - EN 50385
 - EN 60950-1 (safety)
- IEEE 802.3at PoE+
- FCC:
 - FCC Part 15 Class A
 - FCC Part 24 (UMTS Band II only)
 - FCC Part 27 (UMTS Band IV only)
- CE Marking
- NRTL Marking
- RoHS (Directive 2002/95/EC on RoHS)
- R&TTE (Directive 1999/5/EC on R&TTE)
- CB certification as per IEC 60950-1:2011

Radio Node Models

[Table 1](#) displays the orderable configurations of the SCRN-310 radio node:

Table 1: SCRN-310 Radio Node Configurations

Radio Node Model	Description
SCRN-310-0701	Dual-mode with internal antennas: LTE Band 7, UMTS Band 1
SCRN-310-0402	Dual-mode with internal antennas: LTE Band 4, UMTS Band 2

Antennas

The radio node includes four integrated antennas: two UMTS antennas and two LTE antennas. The UMTS radio operates in 1x2 mode with receive diversity. The LTE radio operates in 2x2 mode with MIMO.

Tip: To maximize antenna transmission, SpiderCloud Wireless recommends not installing the radio node inside a metallic enclosure.

Ports

The radio node has one 1 Gigabit Ethernet port that supports a Category 5e (Cat 5e) or better twisted-pair cable with an RJ-45 connector. [Figure 4](#) shows the Ethernet port. There are two LEDs on the connector:

- **Link:** Steady green state indicates a normal Layer 2 link connection has been established.
- **Activity:** Yellow blinking indicates data activity.

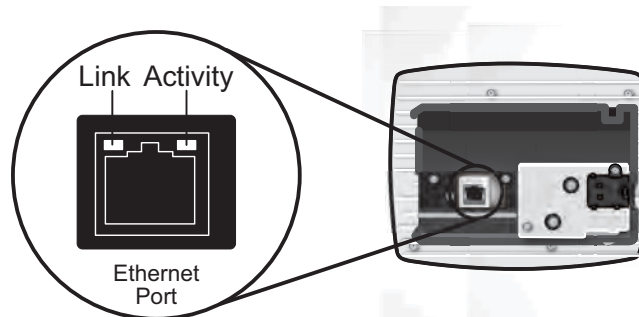

Figure 4 Ethernet Port

The Top-Panel LED

The radio node has one top-panel tricolor LED to indicate power and status. This is the only LED visible under normal operating conditions. When the radio node initially boots the LED cycles through a number of colors and flashing behaviors until it is fully operational.

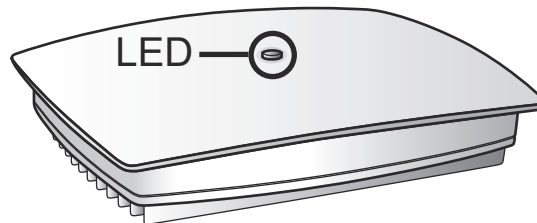

Figure 5 Radio Node Tricolor LED

Input Power

The radio node receives its power from a standard PoE+ switch (typical) or injector. The radio node is fully compliant with the IEEE 802.3at Power Over Ethernet (PoE+) specification.

Per IEEE 802.3at, use standard Cat 5e or better twisted-pair cable with a maximum length restriction of 100 meters (328 feet) for PoE+. This restriction minimizes power loss between the PoE+ power source and the radio node.

Power is distributed over two pairs of the four available pairs in Cat 5e or better cables. The radio node can accept power on either used or un-used pairs.

Figure 6 on page 10 shows the valid radio node cabling/powering options:

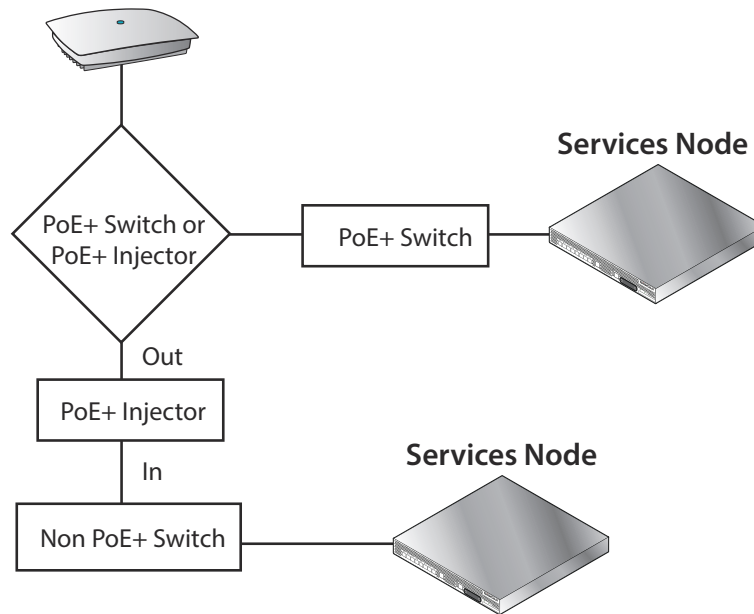

Figure 6 Valid Radio Node Cabling/Powering Options

The illustration below shows a generic single-port PoE+ injector. Use this injector only when a PoE+ Ethernet switch is *not* available.

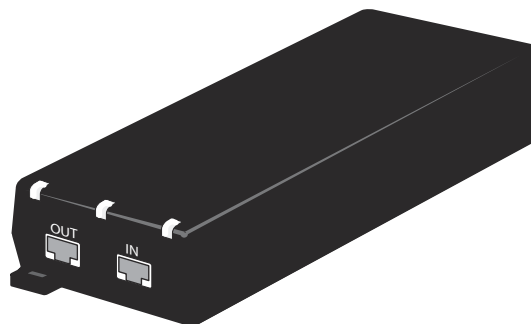

Figure 7 Typical PoE+ Injector

To connect the PoE+ injector to a radio node

Step 1 Attach the injector power cord to a power source.

Step 2 Connect an unpowered Ethernet cable from a switch to the **IN** port on the injector.

Step 3 Connect an Ethernet cable from the injector's **OUT** port to the radio node. The injector will now inject power onto a pair of wire pairs in the cable. The radio node will expect a nominal 48V DC input (57V max) from a typical PoE+ injector.

Select the Radio Node Location

Radio nodes can be installed in a wide range of locations including walls, ceilings, and plenum spaces. Follow the installation guidelines for selecting appropriate mounting locations for the unit. When mounting a radio node vertically, align the bottom-side fins vertically for superior cooling.

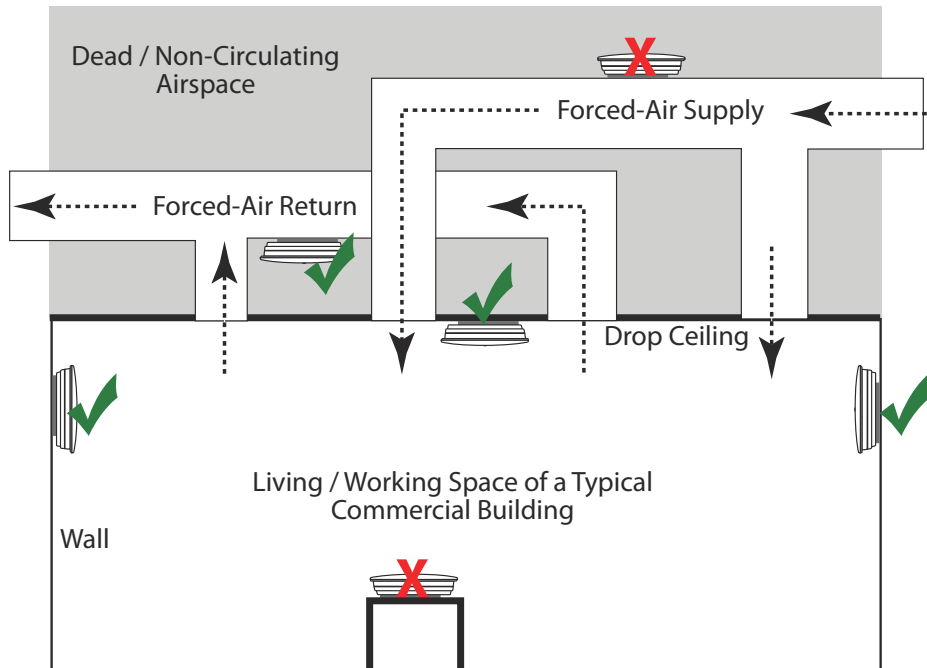

Figure 8 Radio Node Locations

When possible, locate radio node units at least 5 meters (16 feet) from an external wall. This distance maximizes indoor coverage and minimizes RF leakage outside the building. When mounting near a wall or other obstruction, orient the mounting bracket such that the transmit antenna faces towards the coverage area and faces away from the wall. Refer to [Bracket Mounting and Cabling Guidelines](#) on page 13 for more information.

Use [Table 2](#) to determine the maximum distance between radio node units. Greater separation may affect coverage or system performance.

Table 2: Recommended Radio Node Separation Distances	
Type of Building	Max Recommended Separation
Warehouses and large open-spaced buildings	70 m (230 feet)
Open-plan offices	45 m (148 feet)
Closed-plan offices (e.g., individual rooms - plasterboard)	30 m (98 feet)
Closed-plan offices (e.g., individual rooms - stone/brick/concrete)	20 m (66 feet)

Installation and Mount Bracket Assembly

The radio node has a pedestal base that slides into a long bracket for ceiling or wall mounting. SpiderCloud Wireless pre-bolts the pedestal base onto the extrusion plate on the radio node. However you must attach the pedestal base to the mount bracket as shown in [Figure 9](#):

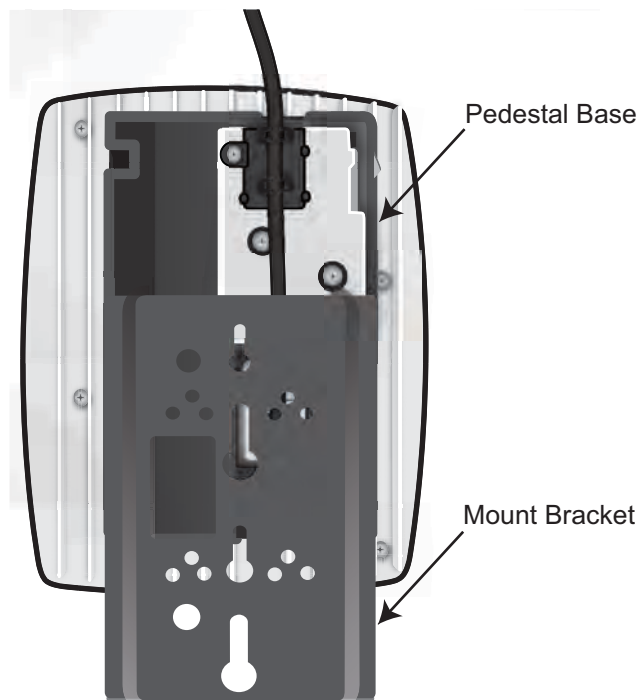

Figure 9 Pedestal Base Slides into Mount Bracket

Bracket Mounting and Cabling Guidelines

Incorrectly cabling and mounting a radio node can result in crushed cables and loss of communications to the unit. Follow these guidelines in cabling the radio node and mounting it on the bracket:

- Ensure that the cabling is properly routed and dressed.
- Ensure that the pedestal base is fully inserted into the mount bracket so that it locks into place and is flush. A correctly installed cable should at no time during installation impede inserting the pedestal base into the mount bracket.
- Secure the pedestal base to the mount bracket with a padlock or tie wrap to provide physical security.
- When mounting the radio node vertically, orient the bracket with the open end on top and the closed end on the bottom. [Figure 10](#) on page 14 shows the proper vertical orientation.
- When mounting the radio node near a wall or other obstruction, orient the bracket such that the radio node transmit side towards the coverage area. In vertical mountings, this is on the right side of the radio node. [Figure 10](#) on page 14 shows the mounting bracket orientation.

Typical Radio Node Mounting Options

Radio nodes can be mounted on a wide number of surfaces including the following typical surfaces:

- **Light grill:** Use bolts, nuts, and washers to secure the mount bracket using holes in the light grill. Adjust the mounting bracket until the bracket and light grill holes align.
- **Directly on the wall or ceiling:** Use drywall screws to secure the mount bracket directly to sheetrock or plasterboard on the wall or ceiling.
- **Mud or plaster ring:** Secure the mount bracket directly on the wall or ceiling as above with a 3 1/4 inch (8.25 centimeter) mud or plaster ring between the mount bracket and the mounting service and run the Ethernet cable through ring's hole.
- **Strutting:** Secure the radio node to heavy hanging equipment strutting using strut clip nuts and M8 studding.

Installing the Radio Node

The radio node receives its power source over powered Ethernet. If your wiring closet does not have existing PoE+ equipment, SpiderCloud Wireless recommends a PoE+ power injector for the radio node. See section [Input Power](#) on page 10.

The Ethernet cable can route openly or directly through a surface such as a wall or ceiling:

- Refer to [Installing the Radio Node \(Method 1\)](#) on page 13 for open cable routing installation.
- Refer to [Installing the Radio Node \(Method 2\)](#) on page 15 for direct cable routing installation.

Installing the Radio Node (Method 1)

To route the cable openly and mount the radio node

- Step 1** With two user-provided screws, attach the mount bracket assembly to a wall or ceiling. The screw holes are sized for an M4 (#10) screw. Ensure the screws have a snug fit onto the studs, sheetrock, anchor, or other material you are bolting onto.

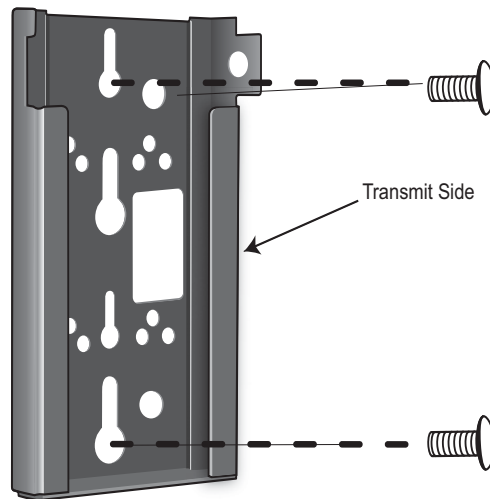

Figure 10 Attach the Mount Bracket

Step 2 Insert the RJ-45 connector into the Ethernet port as shown in Figure 13. Route the Ethernet cable through the cable guides and pedestal base cable opening and through the cable guides as shown in [Figure 11](#):

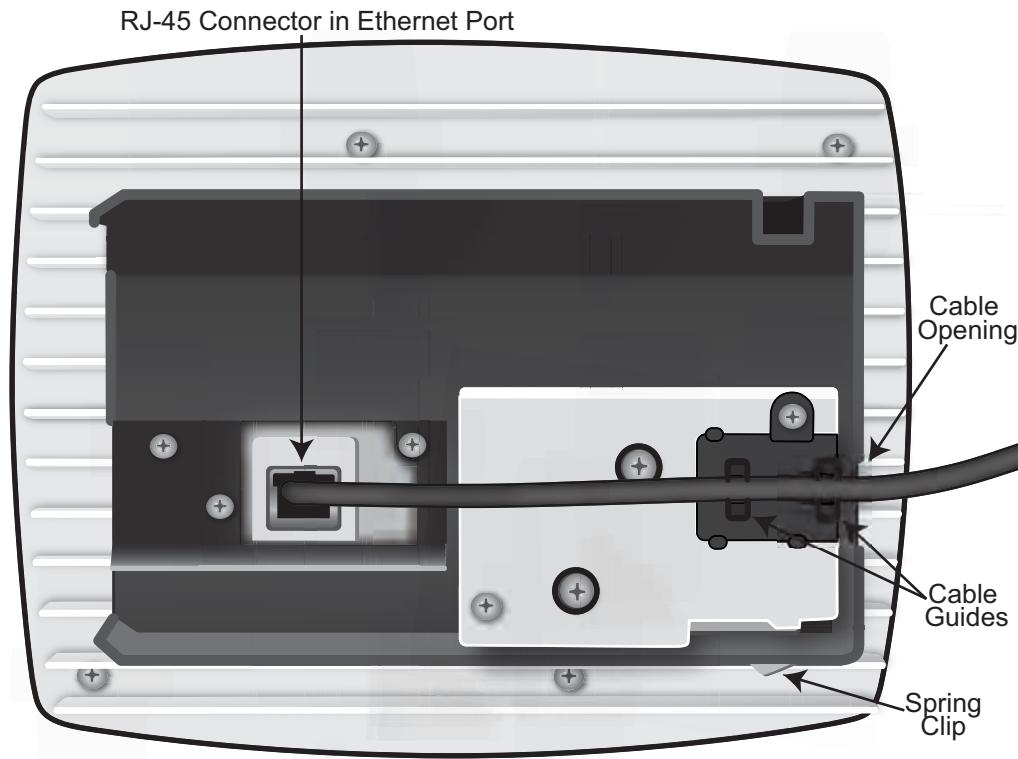

Figure 11 Route and Terminate the Cable

Step 3 Press the cable into the cable guides until the guides securely snap around the cable. Ensure that there is no cable slack and that there is sufficient cable bend radius.

Step 4 Slide the pedestal base of the radio node into the groove opening in the mount bracket. When the pedestal reaches the end of the trough, a spring clip will secure the unit into place.

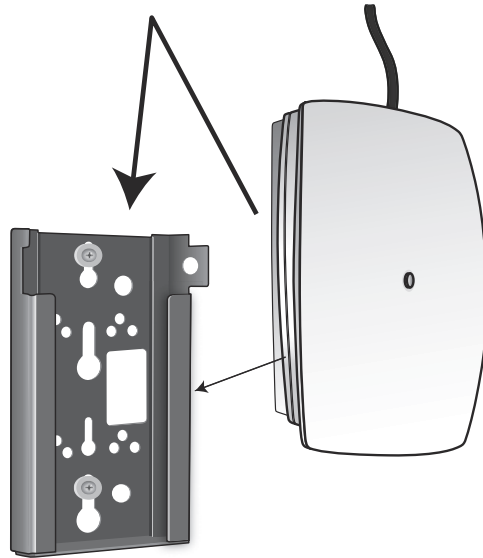

Figure 12 Fully Mounted

Installing the Radio Node (Method 2)

To route the cable directly and mount the radio node

Step 1 Route the Ethernet cable through the large hole in the mounting bracket.

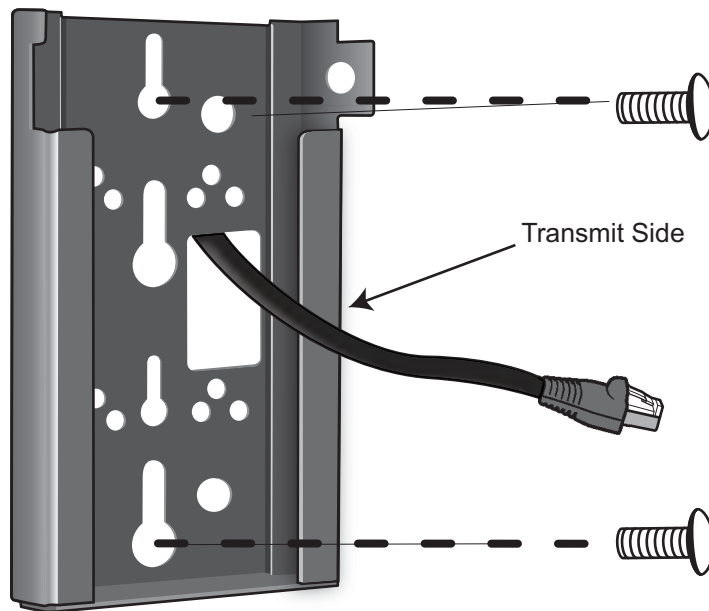
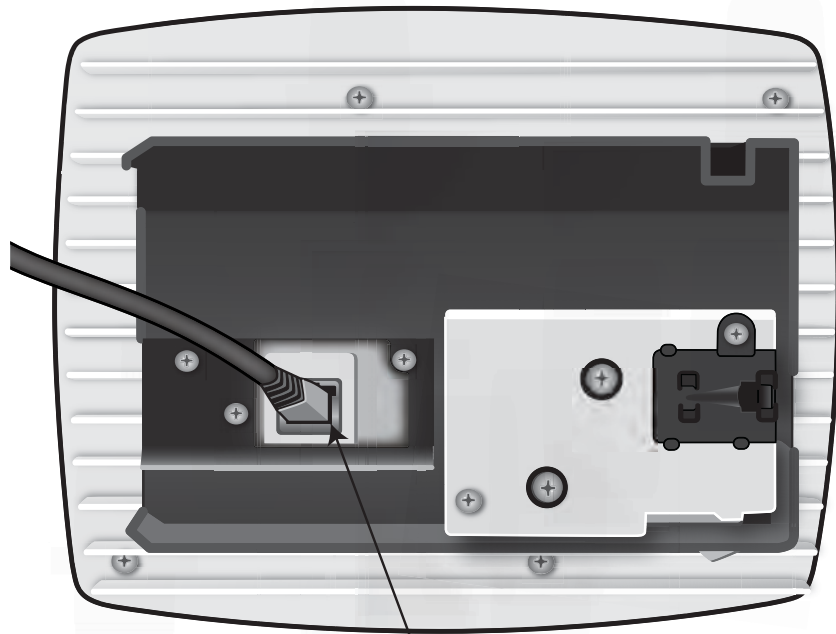

Figure 13 Mount Bracket with Direct Cable Routing

Step 2 With two user-provided screws, attach the mount bracket assembly to a wall or ceiling. The screw holes are sized for an M4 (#10) screw. Ensure the screws have a snug fit onto the studs, sheetrock, anchor, or other material you are bolting onto.

Step 3 Insert the RJ-45 connector into the Ethernet port as shown in [Figure 14](#):



RJ-45 Connector in Ethernet Port

Figure 14 Route and Terminate the Cable

Step 4 Push as much cable back through the wall or ceiling as possible. The mount bracket assembly has room for some cable slack.

Step 5 Slide the pedestal base of the radio node into the groove opening in the mount bracket. When the pedestal reaches the end of the trough, a spring clip will secure the unit into place.

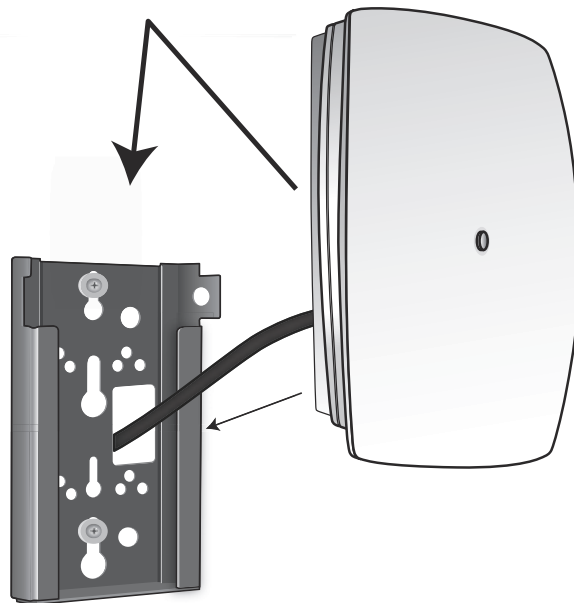

Figure 15 Fully Mounted

Completing the Installation

- Step 1** Attach a padlock or cable tie wrap through the cutout lock holes in the mount bracket and pedestal base.

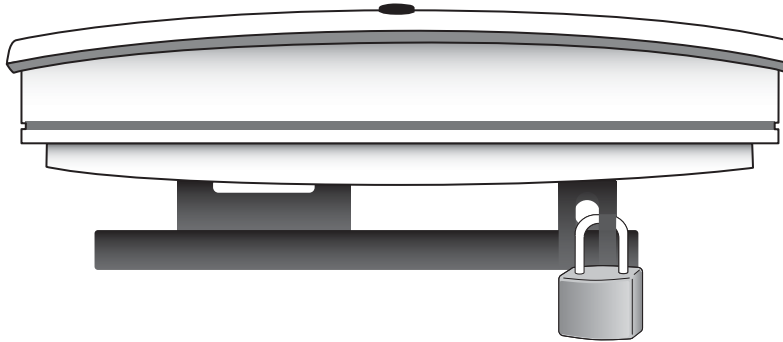

Figure 16 Padlock and Lock Holes

The lock in the above figure is shown schematically. The orientation is for illustration purposes (not accurate) since the bracket is typically wall or ceiling mounted.

- Step 2** The radio node boots up and attempts to connect to the services node. Refer to [Boot Sequence and Services Node Communication](#) on page 18 for more information.

Detaching the Radio Node from the Mount Bracket

To remove the radio node from the bracket assembly

- Step 1** If needed, remove the padlock or cable tie wrap securing the radio node.
- Step 2** Depress the spring clip on the pedestal base and slide the radio node out of the mount bracket.
- Step 3** Detach the RJ-45 clip from the Ethernet port and remove the cable from cable brackets and cable opening.

Boot Sequence and Services Node Communication

On initial boot, the radio node performs the following boot sequence and communicates with the services node. It performs this boot sequence twice, first for the UMTS subsystem, then again for the LTE subsystem. This sequence takes about one minute to complete for each subsystem. When finished, all devices are reachable. [Figure 17](#) shows the radio node boot sequence:

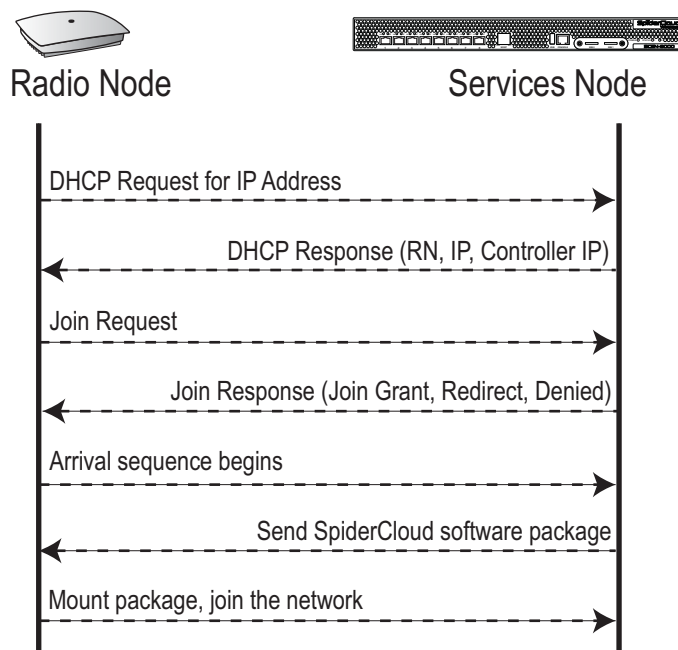

Figure 17 Radio Node Boot Sequence

UMTS Sequence Description:

1. When the radio node is powered on, the device sends a DHCP Request to the services node DHCP server to get IP information. The DHCP server is configured on the services node to respond only to DHCP requests from SpiderCloud Wireless radio nodes. Refer to the *SpiderCloud OS (SCOS) Administrator Guide* for more information about the services node DHCP server configuration.
2. The server responds with the IP addresses of the radio node and the services node (the master of the radio node).
3. Using its own IP address, the radio node sends a Join Request message to the services node. The radio node seeks to join the cellular network.
4. The services node responds with a Join Response message indicating whether the radio node is allowed to join the network or not.
5. The arrival sequence begins. Based on the configuration of the radio node, the radio node will join the system and get its configuration. The services node sends the SpiderCloud software image (the system image and configuration settings) to the radio node.
6. The radio node reboots and mounts the SpiderCloud software image as a RAM-based file system.
7. The radio node contacts the services node and joins the network.

Radio Node LED Boot Sequence

The radio node state machine is sequential and progresses in the following order:

State 0 -> State 1 -> State 2 -> State 3 -> State 4 -> State 5

A normal boot sequence transitions through all these states sequentially and the LED state transitions accordingly. If the radio node fails to transition to the next state, the system restarts the boot sequence, starting with State 0. You can determine the progress during the booting stages by observing the LED color transitions. On failure, the last LED state will display the state that encountered the failure. [Table 3](#) shows the radio node boot sequence and corresponding LED behavior:

Table 3: Radio Node LED Boot Sequence

State	LED Color	Description	Possible Failures and Actions
0. Power On/ Reset	Flashing Green	This is the initial state on startup. The radio node bootup is controlled by firmware in this state. It will go through a lamp test in this state. A lamp test involves cycling through all LED colors.	This state should be very short lived and should transition to the next state immediately. A radio node should not stay in this state indefinitely. Note: Flashing Green is also used to indicate a radio node that has been administratively disabled. This can be determined from the CLI.
1. DHCP	Solid Red	The radio node starts by sending out a DHCP Request. The radio node moves to the next state (State 2) upon receiving a DHCP response and an IP Address.	No DHCP Response, IP Address not allocated. Check cabling, DHCP Server configuration.
2. Join	Solid Blue	The radio node has an IP Address and sends a UDP Join request to the Serving services node. The radio node moves to the next state (State 3) upon getting a JOIN GRANT from the services node.	No IP reachability to the services node. Check IP network between radio node and services node for routing issues.

Table 3: Radio Node LED Boot Sequence (continued)

State	LED Color	Description	Possible Failures and Actions
3. TFTP	Flashing Blue	The radio node proceeds next to download the operating system image from the services node. The radio node moves to the next state (State 4) after the image has been downloaded.	Failure to download TFTP image. Check firewall between radio node and services node.
4. Operating System Booting	Flashing Green	The radio node loads the operating system and starts the default platform applications. The radio node moves to the next state (State 5) when it establishes connectivity with the service node.	Failure to start the operating system. This normally points to a software/build issue. Please contact SpiderCloud support.
5. Running	Solid Green	The operating system is running. The radio node continues the startup sequence, but is now controlled by the services node.	The operating system is up and running on the radio node. Any subsequent state transitions can now be tracked from events and logs on the services node.

Radio Node LED Management

The LED display is active by default, but can be deactivated in light-sensitive environments as needed. Even when the display is disabled, the LED will be lighted during the following conditions:

- while the radio node is booting
- if the radio node or cell is in fault state
- if there is an active emergency call
- if the locate radio node feature is active
- if the follow IMSI feature is active

[Table 4](#) shows the default LED behavior of the radio node:

Table 4: Radio Node LED Behavior

LED	Status	Flash Rate
Green: slow flashing	Administratively disabled	Approximately ½ second on, 1½ sec. off
Green: fast flashing	Booting	Approximately 1.4 second on/off cycle
Green: solid	Operational	
Red: solid	Fault	
Red: fast flashing	One or more emergency calls active	Approximately 1 second on/off cycle

Table 4: Radio Node LED Behavior (continued)

LED	Status	Flash Rate
Blue: fast flashing	Locate radio node enabled*	Approximately 1 second on/off cycle
Blue: solid	Follow IMSI enabled*	
Off	Powered off or LED disabled	

* Refer to the *SpiderCloud OS (SCOS) Administrator Guide* for information about the locate radio node and follow IMSI features.

To disable the LED display

Step 1 From the Configuration Mode, issue the `set System RadioNode LED DefaultMode Dark` command to disable the LED display:

```
set System RadioNode LED DefaultMode Dark
```

Step 2 Issue the `show System RadioNode LED` command to verify the configuration:

```
show System RadioNode LED
DefaultMode Dark;
```

To re-enable the LED display

Step 1 From the Configuration Mode, issue the `set System RadioNode LED DefaultMode Standard` command to re-enable the LED display:

```
set System RadioNode LED DefaultMode Standard
```

Step 2 Issue the `show System RadioNode LED` command to verify the configuration:

```
show System RadioNode LED
DefaultMode Standard;
```

The SpiderCloud Documentation Set

The SpiderCloud documentation set includes:

- The *SpiderCloud System Description* provides an overview of how the SpiderCloud system fits within an operator's network and in an enterprise, describes key features of the system, and provides specifications for the services and radio nodes.
- The *SpiderCloud Feature Description* high-level descriptions of the E-RAN system features, their impact on the product components (services nodes and radio nodes), manageability considerations, and feature benefits.
- The *SpiderCloud OS (SCOS) Administrator Guide* provides procedures for configuring the software environment and internetworking between the services node and radio node devices.
- The *SpiderCloud Services Node Hardware Installation Guide* provides hardware specifications and installation instructions.
- The *SpiderCloud Radio Node Hardware Installation Guide* provides hardware specifications and installation instructions.
- The *E-RAN Deployment Planning Guide* provides information about planning and dimensioning E-RAN systems.
- The *SpiderCloud OS (SCOS) CLI User Guide* provides an introduction to the key features and functionalities of the SpiderCloud Command Line Interface (CLI).
- The *SCOS NB Data Model Reference Guide* provides details about the objects and parameters that comprise the system configuration and operational state.
- The *SpiderCloud OS Faults, Conditions, and Events Reference Guide* provides details about all system faults, conditions, and events.
- The *SpiderCloud System Commissioning Guide* provides information about turning up a SpiderCloud E-RAN with the Local Configuration Interface (LCI) graphical user interface.
- The *Performance Measurements for SpiderCloud Small-Cell E-RAN* provides a reference guide to Key Performance Indicators (KPI) that monitor the health and state of the E-RAN system.
- The *E-RAN Troubleshooting Guide* provides information about diagnosing and correcting problems with installing, provisioning, administering, and maintaining SpiderCloud equipment and services.
- The *SpiderNet Management System Installation and Administration Guide* provides information about installing the SpiderNet network management server and client and using it to remotely manage E-RAN deployments.
- The *SpiderCloud Time Zone Reference Guide* provides the information required to configure the time zone for SpiderCloud services nodes.

Appendix A: UMTS Antenna Patterns

UMTS Band Antenna Patterns

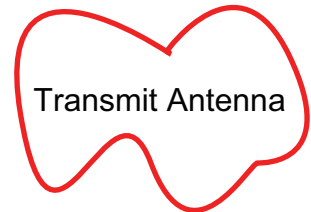
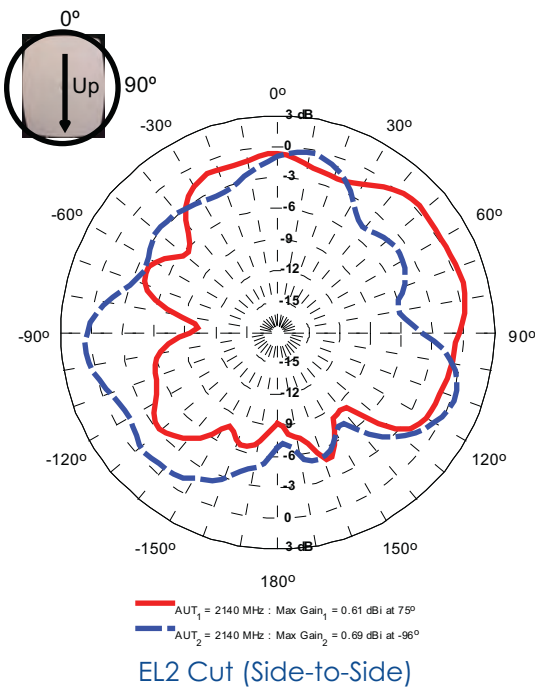
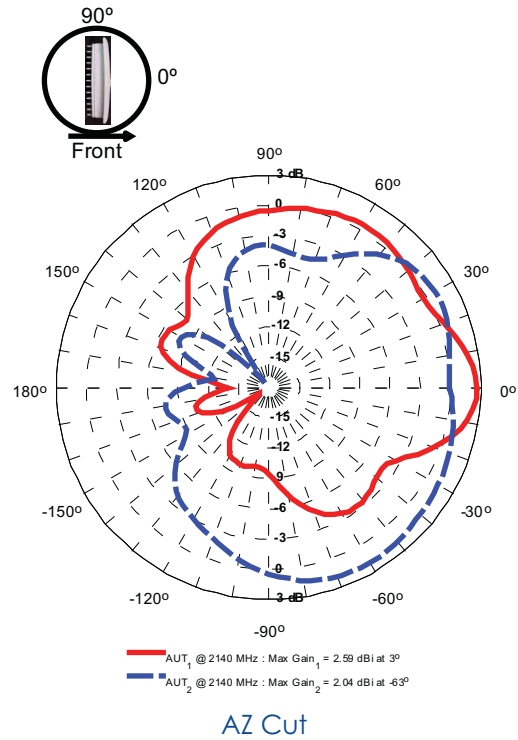
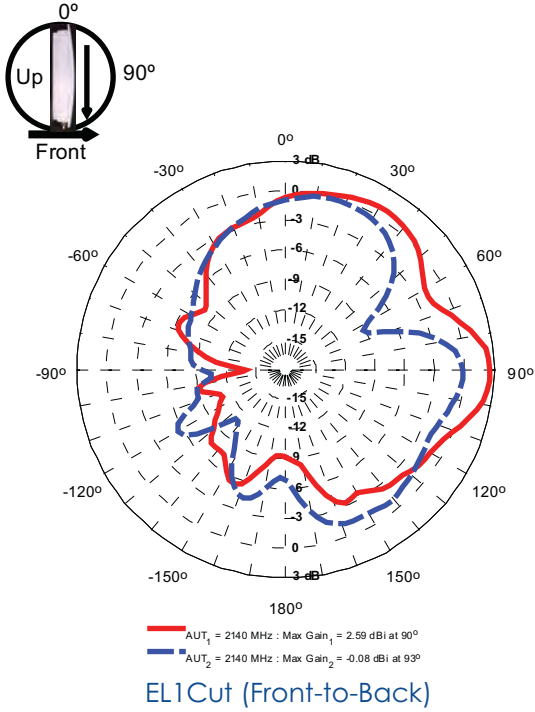

PCS Band Antenna Patterns

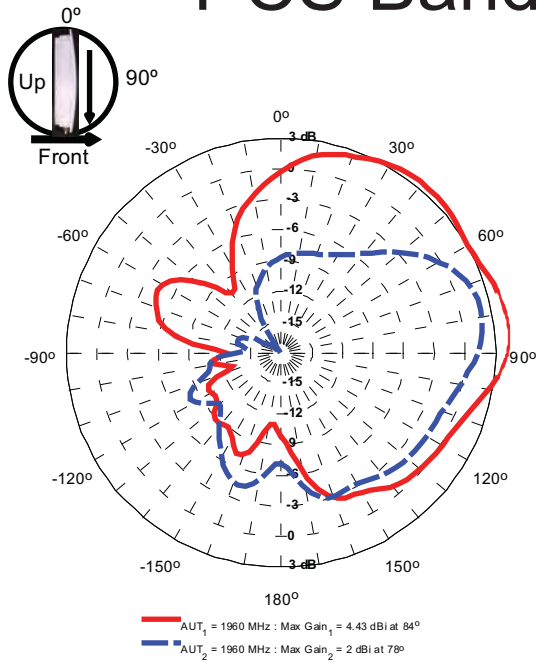

EL1 Cut (Front-to-Back)

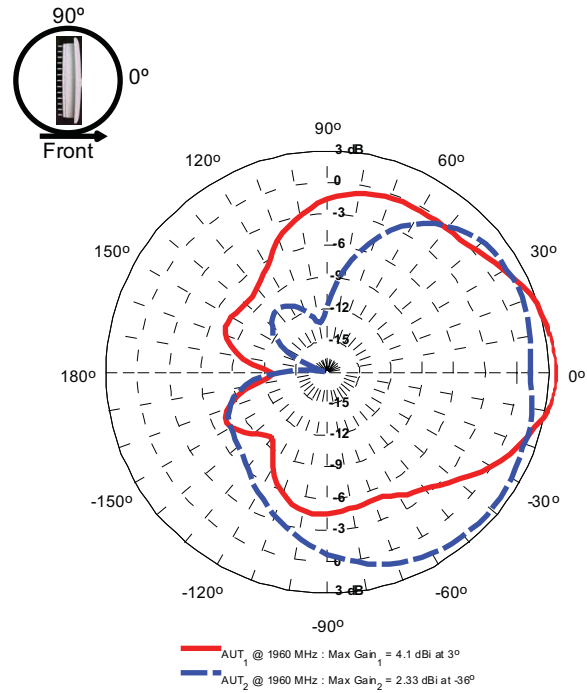

AZ Cut

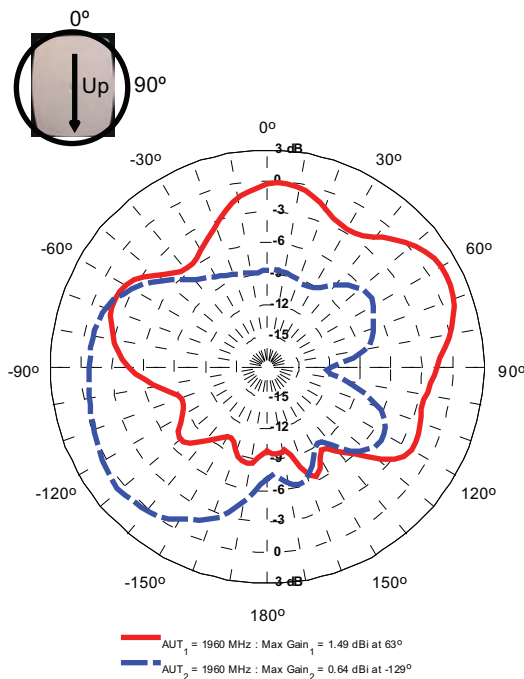

EL2 Cut (Side-to-Side)

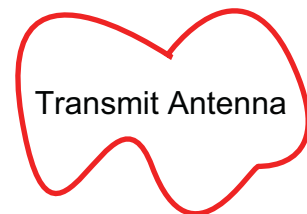

DCS Band Antenna Patterns

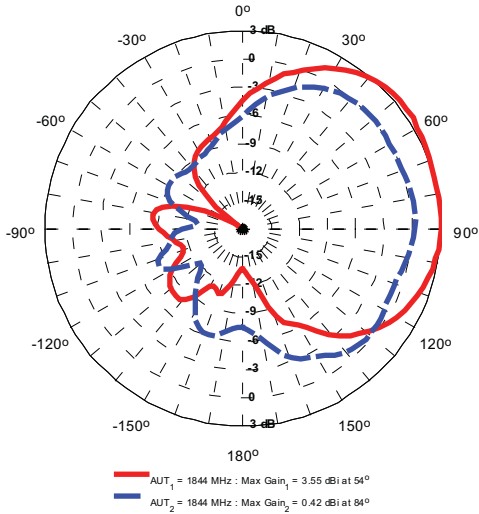
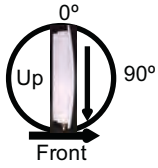

EL1 Cut (Front-to-Back)

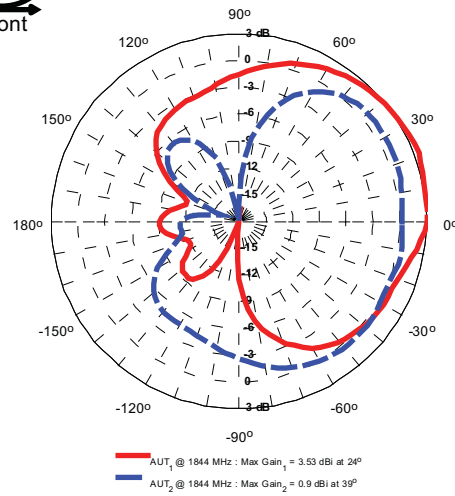
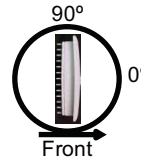

AZ Cut

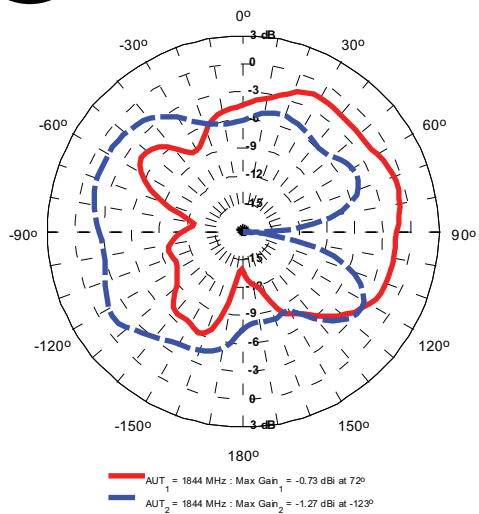
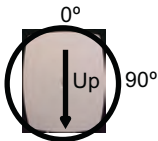

EL2 Cut (Side-to-Side)

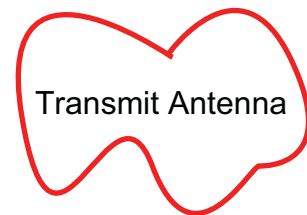

Appendix B: LTE Antenna Patterns

LTE Band 4 Antenna Patterns

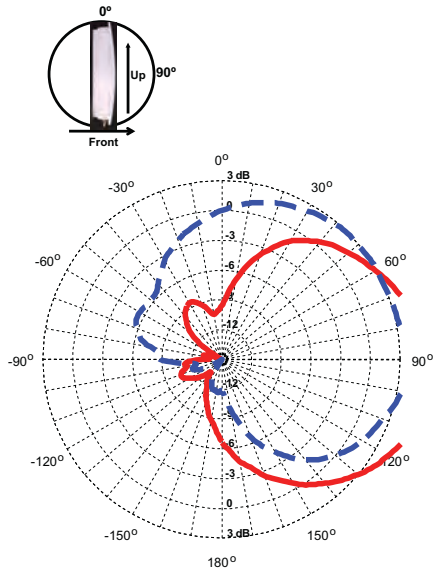

EL1 Cut (Front-to-Back)

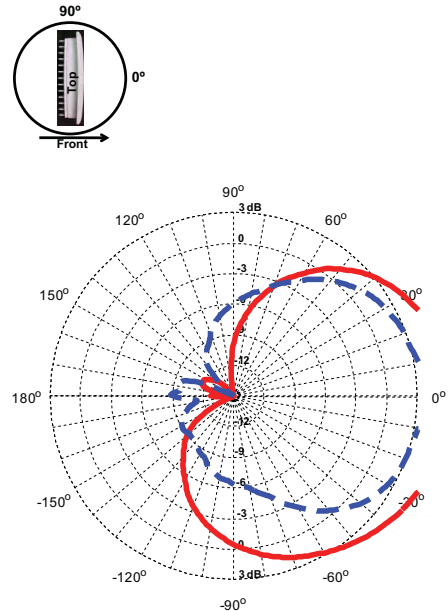

AZ Cut

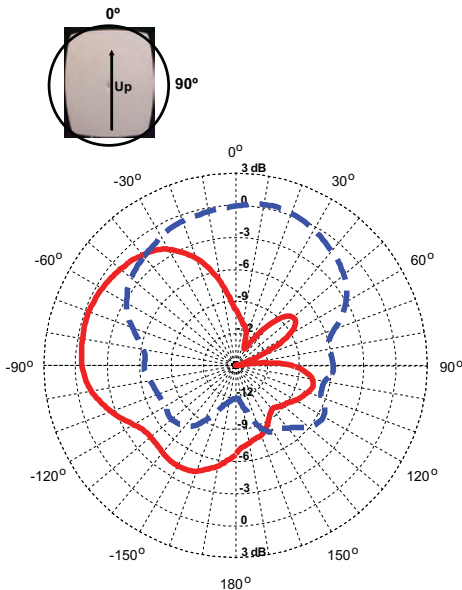

EL2 Cut (Side-to-Side)

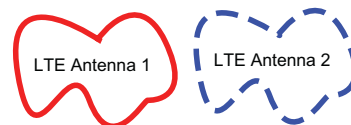

LTE Band 7 Antenna Patterns

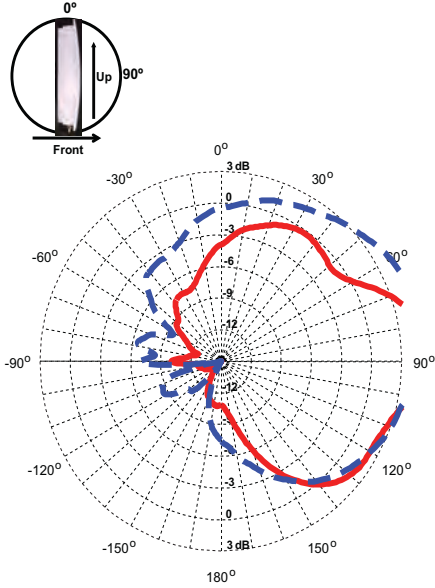

EL1 Cut (Front-to-Back)

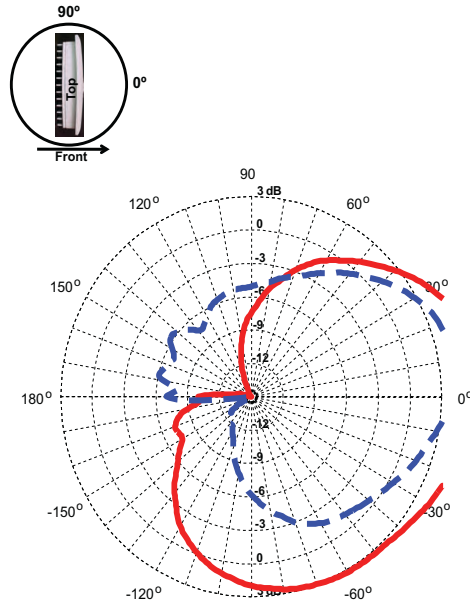

AZ Cut

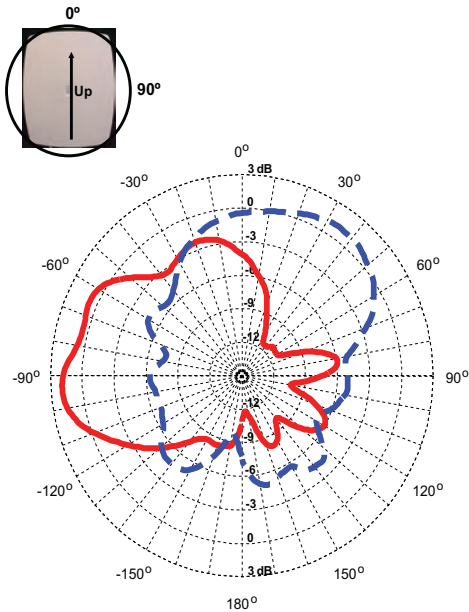

EL2 Cut (Side-to-Side)

