



ego™

Model: #727



Xtreme Sport Cam User manual

EGO062012ENG

Part Names:

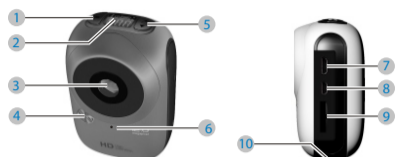

1. Shutter / Select / Wifi Start & Shutdown button
2. LCD Display
3. Camera Lens
4. Mode Light Indicator
5. Power / Mode button
6. Microphone
7. USB Port
8. HDMI Port
9. Micro SD card slot
10. Accessory Knob

This manual explains how to safely operate the Ego Sports Camera. Please read these instructions carefully before using the camera.

! Liquid Image will update the software regularly, please refer to the information on our website and download the newest software. www.liquidimageco.com

Please note before use

1. Check if the Micro SD card of this equipment was installed properly.
2. Check if the memory card has enough free space.
3. The lithium battery must be fully charged before the first use. You can either use the supplied USB cable and charge it with your computer, or use a wall charger (sold separately)
4. A Liquid Image charging cable must be used to avoid damage to the camera.

Basic information



Turn on/off:

The Camera will not function without a Micro SDHC card up to 32GB with a class 6 or higher rating. Insert Micro SDHC card. Turn on the camera by pressing the Mode button. The Camera will turn on in the 720p@60fps Mode (Blue LED). The WiFi signal icon will begin flashing once the WiFi module is available in about 8 seconds. To turn on the Wifi connection, press and hold the Shutter button down for 3 seconds or until the WiFi icon becomes solid (see WiFi setting section of user manual). To turn off the camera, press and hold the Mode button for three seconds.

If the camera remains in standby mode for three minutes, it will automatically power off.

Note: If the WiFi function is on, the function of auto shut down will be inactive.

Firmware Upgrade Procedure:

Copy the firmware file to the root directory of the SD card, outside of the main directory folders. Then, disconnect the USB cable and the camera will automatically shut down. Now, with the camera off, press and hold both the on/off button and the shutter button. Once you hear the camera beep, release both buttons at the same time.

(Please note that LCD will show UP during the process. After the upgrade finishes, the camera will shut down automatically.)

SOS message

When the camera shows SOS, it means the current recording document is damaged; the user can press any key to repair this document.

HOT message

When the LCD display shows HOT, it means the temperature of the camera is too high and needs to shut down for cooling. It won't damage the camera and is only for reminding the user that the temperature of the equipment cannot be too high. The user only needs to reboot the camera after it cools down.

Mode Setting

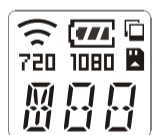

WiFi	wireless WiFi signal icon
Battery	shows the battery level
Photo Mode	Photo mode or Continuous photo mode
SD card	Icon flashes continuously when no SD card is recognized
720	720 mode 720p@60 Frames per second mode
1080	1080 mode 1080p@30 frames per second mode

Mode Switching

When the camera is turned on, the default mode is 720p@60 frames per second. This will be indicated by the LED showing solid blue. To switch between the different modes of the camera, briefly press the mode button.

Pressing the Power / Mode button cycles through the modes in the following order: 720P 60, 1080P 30, Photo, and Continuous Photo. Pressing the SHUTTER and mode buttons at the same time in the 720P/1080P mode will switch to the PAL / NTSC standard. Press the mode button to switch, and press the SHUTTER button to save and exit.

720P@60fps recording mode – Blue LED

Press the SHUTTER button once in the preview mode and the camera will start recording. During the recording process, the blue LED light will flash. Press again to stop recording and the blue LED light will stay solid.

1080P@30fps recording mode – Green LED

In the 720P 60 mode, press the Mode button briefly to switch to the 1080P 30 mode. In the preview mode, press the SHUTTER button once and the camera will start recording. During the recording process, the green LED light will flash. Press again to stop recording and the green LED light will stay solid.

Photo mode – red LED

In the 1080P 30 mode, press the mode button briefly to switch to the Photo mode, and the red LED light will be solid.

With the camera in standby mode, if you wish to take a single photo, press the shutter button briefly. You will hear a beep and see the red LED flash once, which indicates that a single photo has been taken.

Continuous Photo mode – purple LED

In the photo mode, press the mode button briefly to switch to the Continuous Photo mode, and the purple LED light will be solid.

With the camera in standby mode (indicated by a solid purple LED) press the shutter button briefly to activate the continuous shooting mode. You will hear a beep and see the LED flash every time a photo is recorded. To stop the continuous shot mode, press the shutter button again briefly, and the LED will return to a solid state.

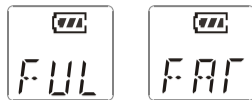

Reminder

When the memory card is full, the LCD display will show FUL.

Tips If you wish to format the memory card, please use the following operation: Insert the memory card into the camera and hold the shutter button. Then, press the Mode button continuously four times in a row. The LCD will then show FAT on the screen which indicates that the MicroSD card is being formatted.

LCD Display

If a Micro SD card is not inserted, and the camera is powered on, the SD card icon on the right side will flash, as shown in P-01 below. If the Micro SD is present in the camera, the LCD screen will display as shown in P-02. The display in the DV mode is as pictured in P-03 below.

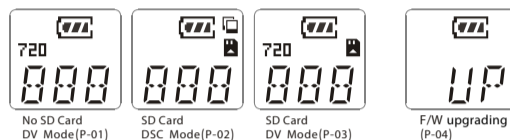

F/W Upgrade Display When Using Micro SD Card:

The LCD display shows picture P-04 above.

Low battery

When the battery is low, the LCD display in Video mode will display like picture P-05. When it is in Camera mode, it will display as shown in P-06. When no bars remain, it will beep 3 times and the word "LO" flashes on the screen, and the LED light will flash red. After it stops beeping, the battery icon will begin to flash.

When the battery is about to cut off, the camera will beep 9-12 times. At this time, the video document that is in the process of recording will be saved before the power is cut off, and the document will be able to be played normally.

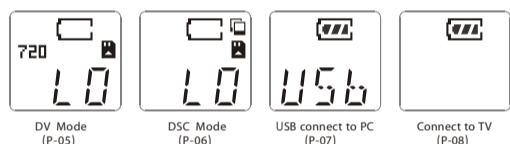

USB connection mode

When the USB is used to connect the camera to the computer, the LCD display will display as shown in P-07. You may access or move the photos and video files in the camera to the computer. At this time, the battery is also simultaneously charging.

HDMI connection mode

When an HDMI cable is used to connect to the TV, the LCD display will display as shown in P-08. The TV will display as shown in P-09.

When the camera is on, connect it to the TV via the HDMI cable. The camera will play the first video automatically and stop after this video is completed. Then, press the shutter button to play the next video, or press the mode button to play the previous video. If you would like to switch to photo mode, press and hold the mode button for 3 seconds. When in photo mode, it will show the first photo automatically. Press the shutter button to advance to the next photo, or press the mode button to display the previous photo. To switch back to the video display, press and hold the mode button for 3 seconds.

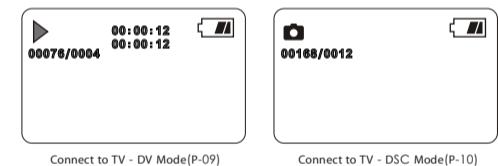

Note:

The TV screen will show the Digital Video playback icon, the battery symbol, the video file number/total number of videos, and the playing time/total time. Picture P-10 is what will be displayed on the TV when connected in photo viewing mode. It will show the picture file number/ total file number and the battery symbol.

Only turn the camera off after it has been disconnected from the HDMI cable, as it will not turn off while still connected to the TV.

When the camera is connected to both the computer and TV at the same time, it will override to the MSDC mode, and the LCD screen will display "USB".

Charging

While charging, the battery symbol will show the animation of the battery charging, and the camera will shut down automatically when it has reached a full charge. If you wish to use the camera while it is charging, you can press the shutter button to switch to the 720p mode. Charging will pause and you will be able to use the camera normally. While charging, the LCD screen will display as in P-11.



Power On	1 Beep sound
Button Pressing	1 Beep sound
Wifi activation	WiFi icon is solid
720P 60 Video mode	Blue light flashes
1080P 30 Video mode	Green light flashes
Photo mode	Red light flashes once
Continuous Photo mode	Purple light flashes
Wifi shutdown	Wifi icon flashes
Low battery, the battery symbol shows empty	Red light flashes, short continuous beep sounds.

Wifi setting

The Wifi feature on the camera is off by default, as displayed by the flashing WiFi icon (Note: The WiFi icon will take around 8 seconds after powering on before it is shown on the LCD screen. Please do not press any buttons until you see this icon)

To activate the feature, simply hold the shutter button for two seconds, and you will hear two beeps, and the LCD display will show a solid WiFi symbol. The WiFi takes 8 seconds to boot, so do not press any buttons during this time.

After the WiFi is activated, press and hold the recording button for two seconds to shut it off. This procedure will be indicated by a flashing WiFi symbol in the LCD screen. When the WiFi is activated, it will automatically shut off if you press the shutter button to begin recording, and will take 8 seconds to complete the shut-down procedure.

(Note: If the WiFi is activated, it will auto switch off if you press shutter button for recording. And the wifi shutdown process may take around 8 second.)

Date, time setting

With the camera switched off, press the SHUTTER button and press the MODE button for two seconds to activate the camera, hold the SHUTTER button, and press the MODE button three times continuously to enter the date and time settings. The sequence of the display is: year-month-day- clock- minute.



The numbers in the LCD screen will flash. To change the numbers press the mode button, and use the shutter button to confirm your selection. After you have completed all of your selections for date and time, press the shutter button and the mode button at the same time to save the settings and exit.

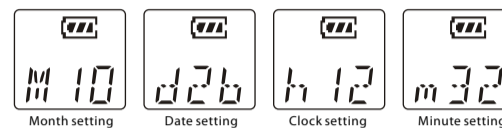

Specification

Item	Specifications
Video Resolution	1080p @30 frames per second, 720p @60 frames per second.
Video file format	H.264 MOV
Audio	Yes, Mono
Photo Resolution	12.0 Megapixels
Photo format	JPEG
Internal memory	256MB
External memory	Micro SDHC Class 6+ up to 32GB
Sensor	3MP sensor
Lens	F/3.2
Field of View	135 degree
Lens focus	0.4m to infinite
Shutter speed	1/2 to 1/8000 second
USB	2.0 High Speed
HDMI	Mini HDMI output
Battery Power	1030mAh
WiFi	Yes

Accessory installation

Accessories:

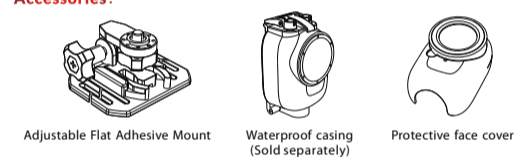

Waterproof Casing Base Assembly:

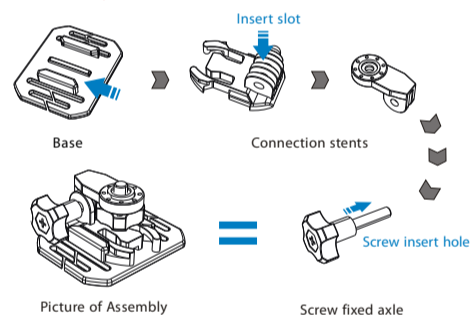

Waterproof casing Assembly:

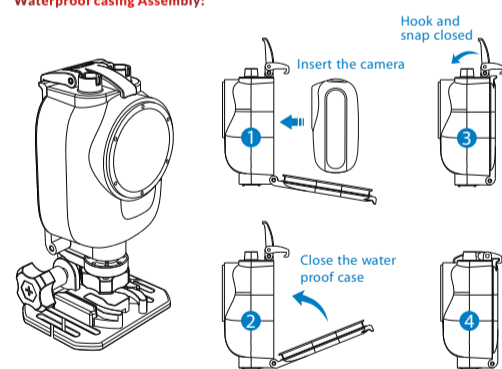

Description:

The waterproof housing for the Ego HD can allow you to use the camera in a variety of environments. The flat adhesive mount connects directly to the base of the housing and allows you a great amount of versatility and mounting options.

Protective Face Cover Assembly:

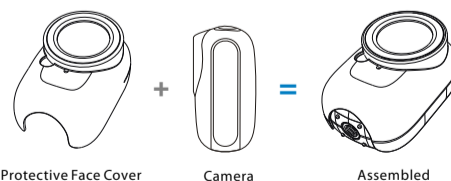

Warning:

Please use care to follow the correct installation steps for the waterproof housing to avoid damage to the camera from immersion.

1. Keep the sticking area clean.
2. The flat adhesive mount needs to attach to a smooth surface.
3. Apply the adhesive mount at room temperature.
4. Let the mount air-dry for 24 hours before use.

WiFi application

Software installation:
You can download and install the "Actionconnect" Application (App) from the Apple Store or Android marketplace. You will be able to see the icon for the application as shown in P-A



(P-A)

Internet setting:
Turn on the WiFi to your iOS/Android device and choose the network named "EGO". (shown in picture P-B)

Active the software:
Click the Action Connect icon, and activate the program to enter the software operation. (as the picture P-C).



(P-B)



(P-C)

Setting
Click the setting icon to enter the setting list, the user can choose the relative setting choice. (As the picture P-D/P-E/P-F below)

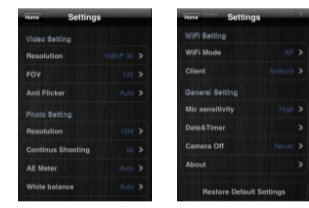

Setting list (P-D)

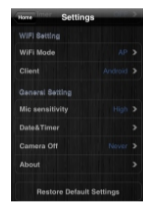

Setting list (P-E)



Time Setting (P-F)

WiFi MODE setting
Click the setting "WiFi Mode", and here the user can modify the name of the SSID. The default SSID for the camera is "EGO". If you would like to set the password, choose the Security option to select WAP2 password protection. Then, choose a password, and press finish. The SSID you choose must be between 1-32 characters without " " and the password must be between 8-16 characters without "?". The WiFi setting will be activated after the EGO reboots, and you should see your new SSID name in the list of wireless networks. (As shown in picture P-G below)

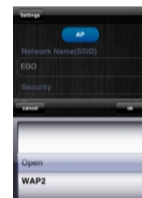
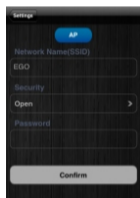

SSID Setting (P-G)

Setting list
Click the setting of your choice, and it will be applied to the camera immediately.

Item	Specifications
Video Setting	
Video Resolution	720p @60 fps, 1080p @30 fps
FOV	135
Anti-flash	Auto, 50Hz, 60Hz
Photo Setting	
Photo Resolution	12MP, 5MP, 3MP
Continuous Photo Mode	On, Off
AE Meter	Auto
White Balance	Auto
Contrast	Soft / Standard / Hard
Self Time	On, Off
Wifi Setting	
Wifi Mode	AP >> Open / WAP2
General Setting	
Microphone sensitivity	High / Medium / Low / Off
Date & Time	Click into date & time setting
Camera Auto Off Time	Never / 3 min / 10 min / 20 min / 30 min
Camera information	Camera parameters and version
RESET	
Recover default setting	OK / Cancel

Shoot
To take a photo, choose the "Shoot" icon. This will activate the "live view interface" that will allow you to see what the camera sees.

Note:
If you enter the "live view interface" and you see the error message "no camera lens connection", you must exit and properly link the camera to your device. (See application settings)



Shoot Mode (P-H)

Share
If you would like to share the files that you have recorded, enter the "Share" menu where you can access the files. (See photos P-I/J/K below).

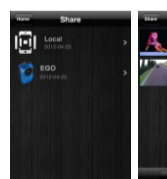

View the file (P-I)

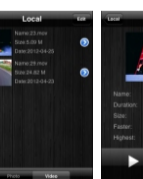

View the file (P-J)

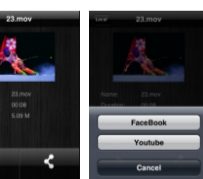

Upload file (P-K)

The live view video is optimized for speed and is best viewed on smart phones or smaller video players. Live view video on iPads or touchpads will be pixelated due to the increased size of the screen. Live view is not the same quality as the HD videos recorded onto the MicroSDHC card.

The conclusion:
Thank you for choosing Liquid Image products! This camera is designed to be the most versatile and compact camera designed for recording your favorite outdoor activities. If you have any questions or concerns, please do not hesitate to contact our customer support team.
support@liquidimageco.com More: www.liquidimageco.com

Commonly asked questions and troubleshooting

- If the connection between your Ego camera and iOS/Android devices is not available, try the following steps:**
 - Start the app (Action Connect) and go into the "Settings" from apps main menu, navigate to WiFi Setting/Client, if your phone is iPhone, select "iPhone" here, if your phone is Android powered, select "Android" here, after the setup, you need to restart your camera to make the setting activated and stored on the camera (Note: by default, the camera is using "Android" protocol, therefore you can omit this step if you are using Android-powered phone, if you are using Apple device, you need to do this step by only one time, the setup will be recorded in the camera after you restart it).
 - Check whether you have Micro SD inside the camera, WiFi will not function properly if no Micro SD card present.
 - Check whether the WiFi icon on the LCD is solid, if the icon is blinking, press and hold "Record" key for 2s till a long beep is heard, which means the WiFi on the camera is activated (Note: if you start recording, WiFi will be automatically turned off)
 - Go to your phone settings and check which WiFi device (SSID) is connected with your phone, by default, the camera will show as "EGO" in the Phone's Settings/WiFi/network list (You are able to change the name of your camera with the "Action connect" application.), if you see the name "EGO" there, try to connect with it.
 - After above steps are executed, enable the Camera WiFi as step 1, connect the phone to camera as step 2, then start apps and go into "Shoot", you should see what the camera sees from the phone.
- Why I can't see the live view in the apps "Shoot" menu**
 - Firstly go through above troubleshooting and make sure all of them are properly configured.
 - if it's still not working, please try the following steps.
 - Power the camera off and then on.
 - Enable the WiFi by pressing and holding "Record" button till a "Beep" sounded.
 - On the phone, Exit from the app then open it again, on the main menu, go into "Settings" to see whether you can get data from the camera, and make sure the WiFi Mode/Client is properly setup.
 - In the apps, back to Home, go into "Shoot", then you should see what Camera sees from there.
- If the camera is no longer working, try the following steps.**
 - Reset the camera by pressing the "Reset" button, which is located nearby the Micro SD slot.
 - Charge the camera with a wall adaptor (Note: if the battery is deeply exhausted, connecting the camera to the wall adaptor will not wake up it automatically, in this case, please manually press the "Power" button to wake up the camera then it will enter into Charging mode.
- What I should do if the Camera shows "Hot" on the LCD**
 - Nothing needs to be done specially, the message just tell you the camera is under heavy loading and becomes too hot to operate in its best, it will automatically stop recording and cool down itself, no need to worry, the camera will protect itself properly, no damage has happened on your camera.
- Why has? the camera stop recording video or capturing photo.**
 - Check whether there have "FUL" on LCD when trying to record, as it indicates the memory is full.
 - Check whether "Hot" is displayed on the LCD which indicates that the camera is overloaded and needs to cool down.
- What I should do if the camera shows "Sos" on the LCD**
 - It could happen when you start the camera, which means some of videos you previously recorded are corrupted for some reason, if this message appears, press any button on the camera and the camera will attempt to repair the corrupted files by itself.
- Why are there two versions of the videos that I record; in two different resolutions?**
 - This camera will record 2 videos when you press record button every time, one video is in the resolution exactly following your selection, either 720p @60 or 1080p@30, and another video in WQVGA (432 * 240) is used for WiFi browsing, playback or uploading.
- Why can't my Android powered phone play the videos properly?**
 - The video format(MOV) taken by the camera is not the core media format supported by Android, you need to install a Android Media player on your phone in advance, which you can find a lot from "Google Play".

For more trouble shooting
Visit our website's help section www.LiquidImageCo.com
Or email our CUSTOMER SUPPORT at support@LiquidImageCo.com

Disclaimer:
While every effort has been made to insure that the information in the guide is accurate and complete, no liability can be accepted for any errors or omissions. Liquid Image Co reserves the right to change the specifications of the hardware and software described herein at any time without prior notice.

Liquid Image Co declines all responsibility for damages due to improper use of this product, failure to adhere to the instructions given in this manual, or modifications to the camera.

Liquid Image Co makes no warranties and shall not be held responsible for damages resulting from corrupted or lost data due to a malfunction of the camera, the software, the memory card, personal computer, peripheral devices, or for any losses that result from files that could not be recorded, are erased, destroyed, or damaged in any way due to a problem or a mistake while utilizing the camera or any of its accessories.

Products mentioned throughout the manual may be trademarks or registered trademarks of their respective companies.

FOR AMERICAN USERS

The following advisory is included in accordance with the laws of the state of California (USA)

WARNING:
This product contains chemicals, including lead on the internal electronic board, known in the State of California to cause cancer, birth defects or other reproductive harm. **Wash hands after handling.**

Warning: Changes or modifications to this unit not expressly approved by the party responsible for compliance could void the user's authority to operate the equipment.

NOTE: This equipment has been tested and found to comply with the limits for a Class B digital device, pursuant to Part 15 of the FCC Rules. These limits are designed to provide reasonable protection against harmful interference in a residential installation. This equipment generates, uses and can radiate radio frequency energy and, if not installed and used in accordance with the instructions, may cause harmful interference to radio communications.

However, there is no guarantee that interference will not occur in a particular installation. If this equipment does cause harmful interference to radio or television reception, which can be determined by turning the equipment off and on, the user is encouraged to try to correct the interference by one or more of the following measures:

- * Reorient or relocate the receiving antenna.
- * Increase the separation between the equipment and receiver.
- * Connect the equipment into an outlet on a circuit different from that to which the receiver is connected.
- * Consult the dealer or an experienced radio/TV technician for help.

Shielded cables must be used with this unit to ensure compliance with the Class B FCC limits.

FOR CANADIEN USERS

This Class B digital apparatus complies with Canadian ICES-003.

Declaration of Conformity

This device complies with Part 15 of the FCC Rules. Operation is subject to the following two conditions:
(1) this device may not cause harmful interference, and
(2) this device must accept any interference received, including interference that may cause undesired operation.

FCC Statement

This device complies with Part 15 of the FCC Rules. Operation is subject to the following two conditions:

- (1) this device may not cause harmful interference, and
- (2) this device must accept any interference received, including interference that may cause undesired operation.

Changes or modifications not expressly approved by the party responsible for compliance could void the user's authority to operate the equipment. This equipment has been tested and found to comply with the limits for a Class B digital device, pursuant to Part 15 of the FCC Rules. These limits are designed to provide reasonable protection against harmful interference in a residential installation. This equipment generates, uses and can radiate radio frequency energy and, if not installed and used in accordance with the instructions, may cause harmful interference to radio communications. However, there is no guarantee that interference will not occur in a particular installation.

If this equipment does cause harmful interference to radio or television reception, which can be determined by turning the equipment off and on, the user is encouraged to try to correct the interference by one or more of the following measures:

- Reorient or relocate the receiving antenna.
- Increase the separation between the equipment and receiver.
- Connect the equipment into an outlet on a circuit different from that to which the receiver is connected.
- Consult the dealer or an experienced radio/TV technician for help.

This device complies with Industry Canada license-exempt RSS standard(s). Operation is subject to the following two conditions:
(1) This device may not cause interference, and
(2) This device must accept any interference, including interference that may cause undesired operation of the device.

Cet appareil s'accorde avec Industrie Canada licence-exempte RSS standard.
(1) Cet appareil ne peut pas causer l'interférence, et
(2) Cet appareil doit accepter de l'interférence, y compris l'interférence qui peut causer l'opération non désirée de l'appareil.

This Class [B] digital apparatus complies with Canadian ICES-003.
Cet appareil numérique de la classe B est conforme à la norme NMB-003 du Canada.

CAUTION
RISK OF EXPLOSION IF BATTERY IS REPLACED BY AN INCORRECT TYPE.
DISPOSE OF USED BATTERIES ACCORDING TO THE INSTRUCTIONS

For your healthy consideration, please keep at least 20CM away from the device while you are using this device.
when the device Connected to the PC , wifi functions doesn't work.

Hinweis zum Umweltschutz:

Ab dem Zeitpunkt der Umsetzung der europäischen Richtlinien 2002/96/EG und 2006/66/EG in nationales Recht gilt folgendes:
Elektrische und elektronische Geräte sowie Batterien dürfen nicht mit dem Hausmüll entsorgt werden. Der Verbraucher ist gesetzlich verpflichtet, elektrische und elektronische Geräte sowie Batterien am Ende ihrer Lebensdauer an den dafür eingerichteten, öffentlichen Sammelstellen oder an die Verkaufsstelle zurückzugeben. Einzelheiten dazu regelt das jeweilige Landesrecht. Das Symbol auf dem Produkt, der Gebrauchsanleitung oder der Verpackung weist auf diese Bestimmungen hin. Mit der Wiederverwertung, der stofflichen Verwertung oder anderen Formen der Verwertung von Altgeräten/Batterien leisten Sie einen wichtigen Beitrag zum Schutz unserer Umwelt.

Note on environmental protection:

After the implementation of the European Directive 2002/96/EU and 2006/66/EU in the national legal system, the following applies:
Electric and electronic devices as well as batteries must not be disposed of with household waste. Consumers are obliged by law to return electrical and electronic devices as well as batteries at the end of their service lives to the public collecting points set up for this purpose or point of sale. Details to this are defined by the national law of the respective country. This symbol on the product, the instruction manual or the package indicates that a product is subject to these regulations. By recycling, reusing the materials or other forms of utilizing old devices/Batteries, you are making an important contribution to protecting our environment.

Remarques concernant la protection de l'environnement:

Conformément à la directive européenne 2002/96/CE et 2006/66/CE, et afin d'atteindre un certain nombre d'objectifs en matière de protection de l'environnement, les règles suivantes doivent être appliquées:
Les appareils électriques et électroniques ainsi que les batteries ne doivent pas être éliminés avec les déchets ménagers. Le pictogramme "picto" présent sur le produit, son manuel d'utilisation ou son emballage indique que le produit est soumis à cette réglementation. Le consommateur doit retourner le produit/la batterie usager aux points de collecte prévus à cet effet. Il peut aussi le remettre à un revendeur. En permettant enfin le recyclage des produits ainsi que les batteries, le consommateur contribuera à la protection de notre environnement. C'est un acte écologique.

Nota sobre la protección medioambiental:

Después de la puesta en marcha de la directiva Europea 2002/96/EU y 2006/66/EU en el sistema legislativo nacional, se aplicara lo siguiente:
Los aparatos eléctricos y electrónicos, así como las baterías, no se deben evacuar en la basura doméstica. El usuario está legalmente obligado a llevar los aparatos eléctricos y electrónicos, así como pilas y pilas recargables, al final de su vida útil a los puntos de recogida comunales o a devolverlos al lugar donde los adquirió. Los detalles quedaran definidos por la ley de cada país. El símbolo en el producto, en las instrucciones de uso o en el embalaje hace referencia a ello. Gracias al reciclaje, al reciclaje del material o a otras formas de reciclaje de aparatos/pilas usados, contribuye Usted de forma importante a la protección de nuestro medio ambiente.

(D) Deutsch [German]	Hiermit erklärt Liquid Image Co, LLC, dass sich dieses Gerät in Übereinstimmung mit den grundlegenden Anforderungen und den übrigen einschlägigen Bestimmungen der Richtlinie 1999/5/EG befindet. Die Konformitätserklärung nach der R&TTE Richtlinie 99/5/EG finden Sie unter www.liquidimageco.com .
(GB) English	Liquid Image Co, LLC hereby declares that this device is in compliance with the basic requirements and other relevant regulations of the 1999/5/EC guideline. You will find the declaration of conformity with R&TTE directive 99/5/EC on the internet at www.liquidimageco.com .
(F) Français [French]	La société Liquid Image Co, LLC certifie que cet appareil est conforme aux exigences de base et aux dispositions de la directive 1999/5/en vigueur. Vous trouverez la déclaration de conformité à la directive R&TTE 99/5/CE sur www.liquidimageco.com .
(E) Español [Spanish]	Mediante la presente, Liquid Image Co, LLC declara que este aparato cumple con los requisitos básicos y los demás reglamentos relevantes de la directiva 1999/5/CE. La declaración de conformidad según la directiva R&TTE 99/5/CE la encontrará en www.liquidimageco.com .

LIQUID IMAGE®

© 2012 Liquid Image Co, LLC
5610 Skyline Blvd., Ste D
Santa Rosa, California 95403
www.LiquidImageCo.com
Ego, Extreme Sport Cams, XSC, and LIC are Trademarks of Liquid Image Co