

*Jazz Hipster Corporation
Home Theatre System*

MUZIX L2

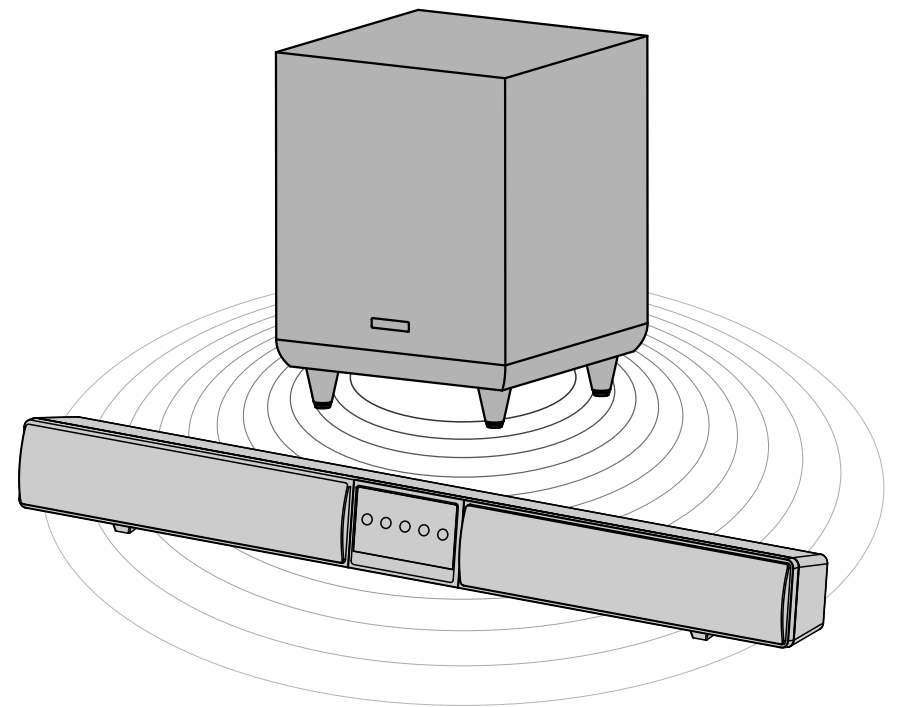

JS6303WA

User Manual

Warning

The apparatus shall not be exposed to dripping or splashing and that no objects filled with liquids, such as vases, shall be placed on the apparatus. The mains plug is used as the disconnected device, which shall remain operable all time.

1. CAUTION: Danger of explosion if battery is incorrectly replaced. Replace only with the same or equivalent type.
2. WARNING: The battery (battery or batteries or battery pack) shall not be exposed to excessive heat such as sunshine, fire or the like.
3.  WARNING: DO NOT INGEST BATTERY, CHEMICAL BURN HAZARD
4. This product contains a coin/button cell battery. If the coin/button cell battery is swallowed, it can cause severe internal burns in just 2 hours and can lead to death.
5. Keep new and used batteries away from children. If the battery compartment does not close securely, stop using the product and keep it away from children.
6. If you think batteries might have been swallowed or placed inside any part of the body, seek immediate medical attention.

For Customers in Europe



Disposal of Old Electrical & Electronic Equipment (Applicable in the European Union and other European countries with separate

This symbol on the product or on its packaging indicates that this product shall not be treated as household waste. Instead it shall be handed over to the applicable collection point for the recycling of electrical and electronic equipment.

By ensuring this product is disposed of correctly, you will help prevent potential negative consequences for the environment and human health, which could otherwise be caused by inappropriate waste handling of this product.

The recycling of materials will help to conserve natural resources.

For more detailed information about recycling of this product, please contact your local Civic Office, your household waste disposal service or the shop where you purchased the product.



Disposal of waste batteries (applicable in the European Union and other European countries with separate collection systems)

This symbol on the battery or on the packaging indicates that the battery provided with this product shall not be treated as household waste.

On certain batteries this symbol might be used in combination with a chemical symbol. The chemical symbols for mercury (Hg) or lead (Pb) are added if the battery contains more than 0.0005% mercury or 0.004% lead.

By ensuring these batteries are disposed of correctly, you will help prevent potentially negative consequences for the environment and human health which could otherwise be caused by inappropriate waste handling of the battery. The recycling of the materials will help to conserve natural resources.

In case of products that for safety, performance or data integrity reasons require a permanent connection with an incorporated battery, this battery should be replaced by qualified service staff only.

To ensure that the battery will be treated properly, hand over the product at end-of-life to the applicable collection point for the recycling of electrical and electronic equipment.

For all other batteries, please view the section on how to remove the battery from the product safely.

Hand the battery over to the applicable collection point for the recycling of waste batteries.

For more detailed information about recycling of this product or battery, please contact your local Civic Office, your household waste disposal service or the shop where you purchased the product.

FCC Statements

This equipment has been tested and found to comply with the limits for a Class B digital device, pursuant to Part 15 of the FCC Rules. These limits are designed to provide reasonable protection against harmful interference in a residential installation. This equipment generates uses and can radiate radio frequency energy and, if not installed and used in accordance with the instructions, may cause harmful interference to radio communications. However, there is no guarantee that interference will not occur in a particular installation. If this equipment does cause harmful interference to radio or television reception, which can be determined by turning the equipment off and on, the user is encouraged to try to correct the interference by one or more of the following measures: Reorient or relocate the receiving antenna. Increase the separation between the equipment and receiver. Connect the equipment into an outlet on a circuit different from that to which the receiver is connected. Consult the dealer or an experienced radio/TV technician for help. FCC Caution: Any changes or modifications not expressly approved by the party responsible for compliance could void the user's authority to operate this equipment. This device complies with Part 15 of the FCC Rules. Operation is subject to the following two conditions: (1) This device may not cause harmful interference, and (2) this device must accept any interference received, including interference that may cause undesired operation.

Radiation Exposure Statement

This equipment complies with FCC/IC radiation exposure limits set forth for an uncontrolled environment. This equipment should be installed and operated with minimum distance 20cm between the radiator & your body. This transmitter must not be co-located or operating in conjunction with any other antenna or transmitter.

IC Statements

IC Regulations: This device complies with Industry Canada license-exempt RSS standard(s). Operation is subject to the following two conditions:

- (1) this device may not cause interference, and
- (2) this device must accept any interference, including interference that may cause undesired operation of the device.

Le présent appareil est conforme aux CNR d'Industrie Canada applicables aux appareils radio exempts de licence. L'exploitation est autorisée aux deux conditions suivantes:

- (1) l'appareil ne doit pas produire de brouillage, et
- (2) l'utilisateur de l'appareil doit accepter tout brouillage radioélectrique subi, même si le brouillage est susceptible d'en compromettre le fonctionnement.

This Class B digital apparatus complies with Canadian ICES-003. Cet appareil numérique de la classe B est conforme à la norme NMB-003 du Canada. This Category II radiocommunication device complies with Industry Canada Standard RSS-310. Ce dispositif de radiocommunication de catégorie II respecte la norme CNR-310 d'Industrie Canada.

IMPORTANT NOTE:

IC Radiation Exposure Statement This device and its antenna(s) must not be co-located or operating in conjunction with any other antenna or transmitter.

L'appareil et son antenne ne doivent pas être co-localisées ou opérant en conjonction avec une autre antenne ou transmetteur.

Important Safety Instruction

1. Read these instructions.
2. Keep these instructions.
3. Heed all warnings.
4. Follow all instructions.
5. Do not use this apparatus near water.
6. Clean only with a damp cloth.
7. Do not block any of the ventilation openings. Install in accordance with the manufacturer's instructions.
8. Do not install near any heat sources such as radiators, heat registers, stoves, or other apparatus (including amplifiers) that produce heat.
9. Do not defeat the safety purpose of the polarized-type plug. A polarized plug has two blades with one wider than the other. The wide blade is provided for your safety. When the provided plug does not fit into your outlet, consult an electrician for replacement of the obsolete outlet.
10. Protect the power cord from being walked on or pinched particularly at plug, convenience receptacles, and the point where they exit from the apparatus.
11. Only use attachments/accessories specified by the manufacturer.
12. Unplug this apparatus during lightning storms or when unused for long periods of time.
13. Refer all servicing to qualified service personnel. Servicing is required when the apparatus has been damaged in any way, such as when the power-supply cord or plug is damaged, liquid has been spilled or objects have fallen into the apparatus, the apparatus has been exposed to rain or moisture, does not operate normally, or has been dropped.
14. Use only with a cart, stand, tripod, bracket, or table specified by the manufacturer or sold with the apparatus. When a cart is used, use caution when moving the cart/apparatus combination to avoid injury from tip-over.
15. The apparatus shall not be exposed to dripping or splashing and that no objects filled with liquids, such as vases, shall be placed on the apparatus.
16. The MAINS plug is used as the disconnect device and shall remain readily operable.
17. Changes or modifications are not expressly approved by the manufacturer could void the user's authority to operate the equipment. Changes or modifications to the device may void FCC and CE compliance. In frequently used radio links should be tested regularly to protect against undetected interference or fault.



Outdoor use or wet location applications:

An apparatus that does not comply with the requirements (Outdoor Use and Wet Location Apparatus) shall be marked or the instruction manual packed with the word "WARNING" and the following or equivalent. To reduce the risk of fire or electric shock, do not expose this apparatus to rain or moisture. A Class II APPARATUS shall be permanently marked with the words "DOUBLE INSULATION" or "Double Insulated" and "When servicing use only identical replacement parts."

Table of Contents

Illustrations
Accessories
Quick instruction – Units & Functions
Precautions
Product specification

Accessories

Operating instruction (1)
Remote control (1)
Audio cable – RCA to 3.5mm stereo plug (1)
24V/2.5A Power adapter (1)
EU plug power cord (2)

Descriptions & Function

Front(Bar)

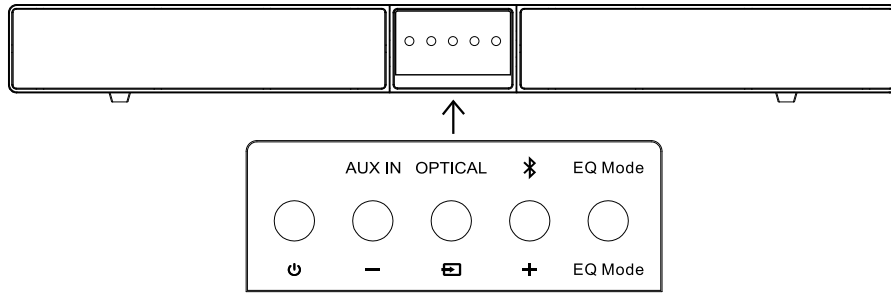

	Short press once to turn on. Short press again to turn off		press 0.1 sec – change Aux/Optical/Bluetooth press 0.3 sec – pairing Bluetooth device (in Bluetooth input mode)
--	---	--	--

Above words will be BLUE indicating current input source: AUXIN OPTICAL

	Volume Down		Volume Up
--	-------------	--	-----------

	Short press to toggle between Movie, Music and Voice EQ mode.	Red: Voice Mode Green: Movie Mode Amber: Music Mode
--	---	---

Back(Bar)

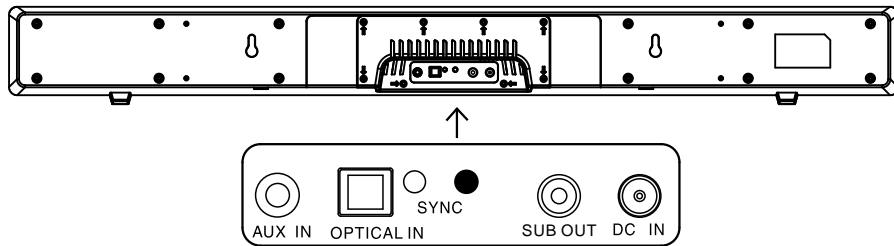

	Connect to the Analog output of an external device.		Connect to the digital (optical) output of an external device.
	Press to connect the subwoofer manually. Blue LED will turn to solid when pairing successful.		Connect the DC power adaptor jack properly, and then connect the AC power adaptor to plug to the wall outlet.
	Connect to external subwoofer by using subwoofer RCA cable		

Remote Control

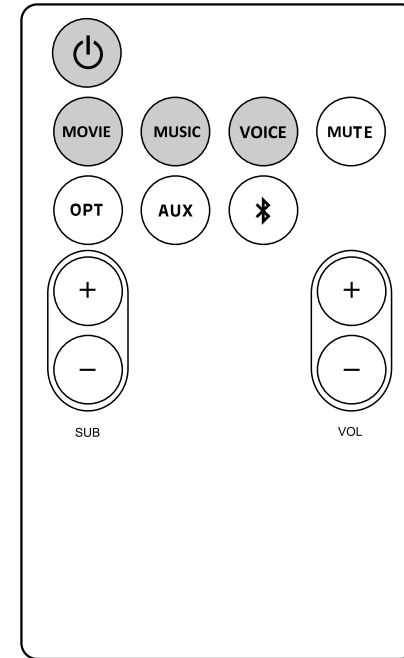

	Turns the sound bar system on and off.		Mutes the sound from the sound bar system. Press again to restore the sound to the previous volume level.
	Select the Movie sound effect.		Press to select the connected Optical input source.
	Select the Music sound effect.		Press to select the connected Analog input source.
	Select the Voice sound effect		Press to select Bluetooth input mode, and long press to enter pairing mode.
	Adjusting the subwoofer level.		Adjusting the volume level of the sound bar system.

Where to Locate Your TV Soundbar

The soundbar comes with rubber feet already attached, so it will sit securely on any flat surface. Just center the bar under your TV screen. If your TV is housed in a media center, you can place the bar above the TV.

If your TV is wall mounted, the bar can mount right beneath it. The bar has built-in keyhole slots that make it easy.

Note: The rubber feet are not detachable and cannot be removed.



INSTALLING THE WALL MOUNT

Installation Precautions

Install on concrete wall only

For the installation, avoid a location with high temperature and humidity, or a wall that cannot sustain the weight of the set. The place should be safe from hazards such as water or crushable items.

Check the strength of the wall. If the wall is not strong enough to support the unit and the TV, reinforce the wall or install the unit on different wall that can sustain the total weight. Purchase and use the fixing screws appropriate for the kind of wall you have (plaster board, iron board, wood, etc.) If possible, fix the support screws into wall studs. Connect cables from the unit to external devices before you install it on the wall.

Make sure the unit is turned off and unplugged before you install it. Otherwise, it may cause an electric shock.

1. Choose the location where you want to mount the sound bar.
2. Fixed screws on the wall. Make sure the distance between two screws is 37cm.
3. Secure the cap on each screw.
4. Hold the sound bar tightly, and place the keyholes near the screws. Make sure the cap (tip side of the screw) is in the keyhole, and slide the bar down gently.

Note: Avoid pushing the sound bar toward the screws harshly. It is advised to complete this step with at least with two people.

If you wall mount your Soundbar, ensure that your wall anchors secure properly into the wall and that they can bear the weight of the Soundbar, which is 1.88 kg.

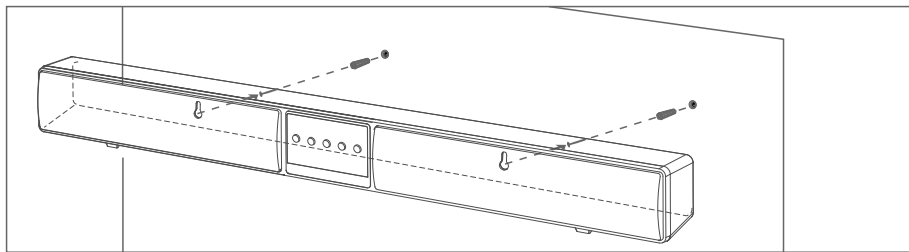

Overall Dimensions

1. 8.1 cm
2. 81.5 cm

Keyhole Slots

3. 37 cm
4. 2.05 cm

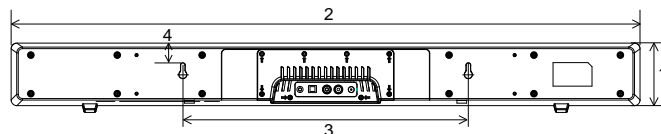

Connecting the wireless subwoofer

The subwoofer is preset at the factory and should link with the sound bar automatically when both main bar and subwoofer are turned on. If the LED indicator on the back keep flashing red/green light, when the main bar is turned on and has music/source input, please set the subwoofer by following procedures below.

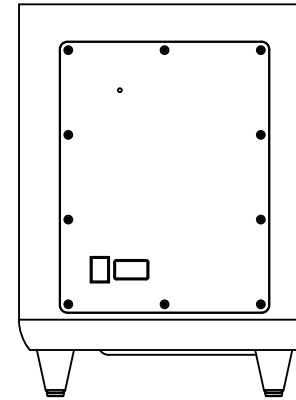

1. Plug the power cords of the main unit and subwoofer into an AC wall outlet.
2. Press the power switch to "on" on the back of the subwoofer. Press the power button on the main bar.
3. Press the SYNCH button on the back of the sound bar. The green LED will blink quickly.
4. When the pairing is finished, the LED indicator on your subwoofer will turn to solid green.

! If there has no music input for a while, the subwoofer will enter STANDBY mode, and the LED indicator will flash red and green slowly. In this case, you just need to play some music and the subwoofer will be active again.

Listening to TV sound from the sound bar

Control the volume of the unit by adjusting your sound bar

- 1 Turn on the soundbar, or make sure the unit is in standby mode.
- 2 Turn on the TV.
- 3 Adjust the volume of the soundbar.

Control the volume of the unit by adjusting the TV volume

If the sound output jack of the TV can be set to "Variable", the volume of the soundbar can be changed by adjusting the TV volume. For TV settings, refer to the operating instruction of the TV.

- 1 Set the sound output jack of the TV to "Variable".
- 2 Adjust the volume of the unit according to the TV
- 3 Adjust the volume of the soundbar





Selecting the sound field

Press one of the sound field buttons you want to use.





Sound field	Effect
MOVE	Suitable for use for a wide range of sources of any type.
MUSIC	Provides dynamic sound and realistic sensation.
VOICE	Features easy-to-hear dialogue and clear sound.

Bluetooth Pairing Process

A. Pairing from control panel

- 1 Press  front panel to switch the source to Bluetooth Mode ,
- 2 LED light of Bluetooth sign  turns on .
- 3 Press  1 second,  light starts breathing , after 5 seconds sound tone indicated “du du”, the system into pairing mode .
- 4 Turn on the Device Bluetooth connect. Select the Bluetooth domain name MUZIX L2.
- 5 There is no No password required. After the “Beep” sound tone, the system is successfully connected.

B. Pairing from remote control

- 1 Press  on remote control to switch the source to Bluetooth Mode .
- 2 LED light of Bluetooth sign  turn on in soundbar .
- 3 Press  button on remote control  light starts breathing , after 5 seconds sound tone indicated “du du”, the system go into pairing mode .
- 4 Turn on the Device Bluetooth connect. Select the Bluetooth domain name MUZIX L2.
- 5 There is no No password required. After the “Beep” sound tone, the system is successfully connected.

Reconnecting

- 1.New Device Reconnect:The original connected device must forget the Bluetooth connection of MUZIX L2 first, and then follow the Bluetooth connection method A or B, step 1 to 5, for connecting a new device.
- 2.For Current Device:The connected device will automatically connect when system power on or when switch back to Bluetooth from different input source. Only when the connected device chooses “forget the soundbar domain name”, MUZIX L2 will be able to reconnect new device.

Precautions

On safety

Should any solid object or liquid get into the unit, unplug the unit, and have it checked by qualified personnel before operating it again

On power sources

- Before operating the unit, check that the operating voltage is identical with your local power supply.
- Do not plug the AC power cord (mains lead) for the unit into an electrical outlet until you have made all other connections. Make sure the TV or other equipment is unplugged from the electrical outlet prior to connecting it to the unit.
- Do not connect the AC power cord (mains lead) to a voltage transformer or inverter. Connecting the AC power cord (mains lead) to a voltage transformer for overseas travel or an inverter for use in an automobile may cause heat to build up in the AC adaptor and may cause burns or a malfunction.

- Do not use an AC adaptor or AC power cord (mains lead) other than the supplied AC adaptor and AC power cord (mains lead). Do not modify the cord.
- Do not touch the plug of the AC power cord (mains lead) with wet hands.
- Do not touch the AC power cord (mains lead), AC adaptor or the unit, if connected to an electrical outlet, during an electrical storm.
- Do not place heavy items on the cord.
- Do not place the AC power cord (mains lead) near heating equipment and do not expose the cord to heat.
- Completely disconnect the AC power cord (mains lead) from the wall socket (mains) if it is not going to be used for an extended period of time. When unplugging the unit, always grip the plug. Never pull the cord itself.
- Do not place the unit in an inclined position or in locations that are extremely hot, cold, dusty, dirty, or humid or lacking adequate ventilation, or subject to vibration, direct sunlight or a bright light.
- Be careful when placing the unit on surfaces that have been specially treated (for example, with wax, oil, polish) as staining or discoloration of the surface may result.
- Since a strong magnet is used for the speakers, keep personal credit cards using magnetic coding or spring-wound watches away from the unit to prevent possible damage from the magnet.

On heat buildup

- Heat buildup on the unit during operation is normal and is not a cause for alarm.
- Do not touch the cabinet if it has been used continuously at a high volume because the cabinet may have become hot.
- Do not obstruct the ventilation holes.

On cleaning

Clean this unit with a soft cloth slightly moistened with a mild detergent solution. Do not use any type of abrasive pad, scouring powder, or solvent, such as thinner, benzene, or alcohol.

Specifications

Model Name JS6303WA

General	Power Supply	Bar	24V/2.5A DC input
		Subwoofer	AC100-240V~ 50/60Hz
	Dimensions	Bar	W815XH90XD81 mm
		Subwoofer	W240XH323XD240 mm
	IR Remoter	Yes	
Operation Indicator	LEDindicator		
Input Source	Analog:3.5mm Phone Jack		
	Digital:Optical		
User Interface	Digital:Bluetooth		
	Button(5 keys)		
Amplifier	Gradually Volume Control		Power ON/Source Change
	Rated Output	Bar	20W/CH,8 ,THD=10%,1KHz
		Subwoofer	65W/4 ,THD=10%,100Hz
	Output Gain	-∞dB,-40dB~ +4dB	
	Amplifier	Class D	
Sound Effect	Movie/Music/Voice		